

003606

Agreement



BY AND BETWEEN

LOS ANGELES COUNTY,
PUBLIC WORKS

AND

VALLEY VISTA SERVICES, INC.

FOR

THE EXCLUSIVE COMMERCIAL FRANCHISE CONTRACT FOR
THE AREA OF SAN GABRIEL VALLEY EAST (BRC0000246)



Part I

Contract

BETWEEN

COUNTY OF LOS ANGELES BOARD OF SUPERVISORS

AND

VALLEY VISTA SERVICES, INC.

FOR PROVISION OF COMMERCIAL SOLID WASTE COLLECTION SERVICES

(BRC0000246)

FOR THE SERVICE AREA OF

SAN GABRIEL VALLEY EAST

WITH A SERVICE COMMENCEMENT DATE AS EARLY AS

OCTOBER 1, 2022

TABLE OF CONTENTS

**FOR THE CONTRACT FOR THE SERVICE AREA OF
SAN GABRIEL VALLEY EAST (BRC0000246)**

SECTION 0 - RECITALS:..... 0-1

SECTION 1 - GRANT OF RIGHTS AND PRIVILEGES 1-4

A. Requirements/Grant of Rights..... 1-4

B. Exclusions from Service 1-4

C. Exceptions from Exclusivity..... 1-9

D. Fees to COUNTY 1-10

E. Ownership of Solid Waste 1-10

SECTION 2 - TERM OF CONTRACT 2-11

A. Term of Contract Services 2-11

B. Obligations Upon Expiration or Termination of CONTRACT 2-12

C. Undepreciated Assets 2-14

SECTION 3 - SCOPE OF SERVICES AND SPECIFICATIONS 3-15

A. Prescribed Scope..... 3-15

B. Change in Scope of Services 3-16

C. Vehicles 3-16

SECTION 4 - SERVICE STANDARDS 4-21

A. Public Health and Safety; Nuisances 4-21

B. Private Property 4-22

C. Non-Collection..... 4-23

D. Compliance with Civil Rights Law 4-23

E. CONTRACTOR Waste Reduction Practices..... 4-23

F. Customer Correspondence and Other Materials..... 4-23

G. Publicity and News Media Relations 4-24

H. Responsiveness to County 4-24

I. No Commingling of Solid Waste..... 4-25

J. Key Personnel..... 4-25

K. Uniforms..... 4-26

L. Confidentiality..... 4-26

M. Single-Pass Collection 4-27

N. Professional Manner 4-29

O. Privacy 4-29

SECTION 5 - ADDITIONAL CONTRACT PROVISIONS 5-30

SECTION 6 - CUSTOMER SERVICE 6-31

A. Facilities 6-31

B. Telephone Service 6-31

C. Paperless/Electronic Information and Services..... 6-32

D. Responses to Customer Complaints and Other Correspondence..... 6-34

E. Service Interruption 6-35

- F. Responsiveness to Customer 6-36
- G. Setting Up or Terminating Service 6-36
- H. No Evergreen 6-37
- I. Term Limitation 6-37
- J. No Charges 6-37
- SECTION 7 - SERVICE RATES AND BILLING 7-38**
 - A. Customer Service Rates 7-38
 - B. Customer Invoice and Payment 7-40
- SECTION 8 - WASTE CHARACTERIZATION STUDY 8-43**
 - A. Participate with County Study 8-43
- SECTION 9 - RECORDS 9-44**
 - A. Record Maintenance and Retention 9-44
 - B. County Custody 9-45
 - C. Inspection and Review of Records 9-45
 - D. Copies of Audits 9-46
 - E. Submission of Records 9-46
 - F. Public Record Request 9-46
- SECTION 10 - REPORTS 10-48**
 - A. Types and Content 10-48
 - B. Submission of Reports 10-55
 - C. Reporting Adverse Information 10-55
 - D. County's Right to Request Information 10-56
 - E. Reports of Cybersecurity Breaches 10-56
- SECTION 11 - SUBSTITUTE, EMERGENCY AND BACK-UP SERVICE 11-57**
 - A. Director's Right to Provide Contract Services 11-57
 - B. Customer Services - Response to Emergencies 11-59
 - C. Backup Service Plan 11-60
 - D. Use of Goods, Services and Property 11-62
- SECTION 12 - ENFORCEMENT OF CONTRACT 12-64**
 - A. As Provided by Law 12-64
 - B. COUNTY's Additional Remedies 12-64
 - C. Injunctive Relief 12-64
 - D. Recovery of Damages 12-65
 - E. County's Reimbursement Costs 12-67
 - F. Waiver 12-67
- SECTION 13 - UNPERMITTED WASTE SCREENING AND REPORTING 13-68**
 - A. Protocol 13-68
 - B. Prohibition on Collection 13-68
 - C. Notice to Director 13-68
 - D. Labels 13-68
- SECTION 14 - EXECUTION OF CONTRACT 14-69**

- A. Execution in Counterparts 14-69
- B. Authority to Execute 14-69
- SECTION 15 - PERFORMANCE ASSURANCE 15-70**
 - A. Performance Bonds, Other Security 15-70
 - B. Further Assurances 15-71
- SECTION 16 - CONTRACT SERVICE AREA INFORMATION 16-73**
 - A. Maps 16-73
 - B. Service Areas Data Information 16-73
 - C. Outreach 16-73
- SECTION 17 - CONTRACTOR DOCUMENTATION 17-74**
 - A. CONTRACTOR's Compliance with CONTRACTOR Documentation 17-74
 - B. Changes in CONTRACTOR Documentation 17-74

This exclusive franchise contract (CONTRACT) is made and entered into on _____, 2022, by and between COUNTY of Los Angeles Board of Supervisors, acting in their capacity as the governing body COUNTY of Los Angeles (COUNTY), and Valley Vista Services, Inc., a California Corporation, located at 17445 East Railroad Street, City of Industry, California 91748, (hereinafter referred to as CONTRACTOR).

SECTION 0 - RECITALS:

Purpose. To limit the wear and tear on COUNTY streets, reduce pollution from Collection and Vehicle exhaust, increase customer service accountability, ensure compliance with Federal, State, and local laws, including Assembly Bills (AB) 341, 939, 1826, and Senate Bill (SB) 1383, by improving program implementation performance and reporting accuracy, and facilitate more efficient CONTRACT administration and enforcement by COUNTY staff.

Solid Waste Haul Permits. County of Los Angeles Department of Public Health issues permits to haulers for the hauling of Solid Waste with requirements to protect public health and safety, including frequency of Collection and Collection Vehicle maintenance. CONTRACTOR shall continue to obtain that permit and comply with all its provisions throughout the life of this CONTRACT; and

Mandatory Solid Waste Diversion. The State of California has found and declared that the amount of Solid Waste generated in California coupled with diminishing landfill space and potential adverse environmental impacts from land filling have created an urgent need for State of California and local agencies to enact and implement an aggressive, new integrated waste management program. Through enactment of AB 939, the State of California has directed agencies, such as COUNTY to Divert 50 percent of all Solid Waste through source reduction, recycling, and composting activities. The California Department of Resources Recycling and Recovery (CalRecycle) had granted COUNTY a timeline to achieve compliance with the AB 939 Diversion requirements to which COUNTY had met. Additionally, with the passage of Senate Bill 1383, COUNTY must comply with CalRecycle's requirements related to diversion of Organic materials such as Food Waste, Green Waste, and food-soiled paper, for the purpose of reducing short-lived climate pollutants such as methane and its impact on climate change. Non-compliance may subject the County to penalties and fines of up to \$10,000 per day. Continued compliance is based in part on executing and implementing this CONTRACT to secure cooperation with CONTRACTOR's AB 939 waste Diversion programs, record keeping, and reporting; and

County Zero Waste Plan. COUNTY Board of Supervisors adopted the Roadmap to a Sustainable Waste Management Future in 2014. It is a comprehensive plan for a waste free future and is a proactive approach to developing innovative policies for managing waste that further reduces COUNTY's reliance on landfills. It established the following intermediate and long-term disposal reduction targets: 80 percent Diversion from landfills by 2025, 90 percent Diversion from landfills by 2035, and at least 95 percent Diversion from landfills by 2045. The COUNTY updated the plan in 2021, referred to as the Zero Waste Plan; and

Municipal Solid Waste Discarded in Containers. The County has determined to provide for Municipal Solid Waste (MSW) Management Services in portions of Los Angeles County under the terms of this CONTRACT for reasons including the following:

- To enable businesses and residents located in the Service Area that discard Solid Waste in Dumpsters to receive quality MSW Management Services, and
- To provide COUNTY with programs, records, and reports that will help COUNTY comply with AB 939, AB 341, SB 1383, and other Laws.

Compliance with Law. CONTRACTOR shall perform Contract Services in accordance with all the Laws governing the safe Collection, transport, Recycling, and Disposal of Residential and Commercial Solid Waste, Including AB 939 and AB 341, SB 1383, Recovered Conservation and Recovery Act (RCRA), and Comprehensive Environmental Response Compensation and Liability Act (CERCLA).

CONTRACTOR / "Arranger". Under this Contract, COUNTY may exercise control over the Disposal or other disposition of the Solid Waste handled by the CONTRACTOR, commonly referred to as flow control. It may designate or determine the use of any given Solid Waste Facility. Although minimum scope of Contract Services, Service Specifications, and Service Standards are set forth in this CONTRACT, COUNTY has not, and by this CONTRACT does not, supervise Contract Services or assume title to Solid Waste; and

Competitive Procurement. COUNTY issued a Request for Proposals (RFP) or Invitation for Bids (IFB) to provide Contract Services under this CONTRACT. Private waste hauling companies submitted proposals or bids, including their proposed schedule of rates and charges. COUNTY selected the CONTRACTOR based, among other things, on CONTRACTOR's price proposal and work plan for Collection Services.

Compensation. The following describes the compensation allowed under this CONTRACT:

- Exhibit 7 provides for CONTRACTOR's compensation under Collection Services. Under this CONTRACT, the CONTRACTOR cannot charge its Customers more than the Customer Service Rates as stipulated in Attachment 7-2 Service Rates in Exhibit 7.
- Except as otherwise allowed under this CONTRACT, CONTRACTOR is not allowed to add any surcharges in addition to the fees that were entered on Form PW-2 and PW-3, Schedule of Prices. Any fuel, environmental, or other fees must be included in the original bid and may not be added later.

Franchise Authorization. PRC Section 40059 specifically authorizes COUNTY to prescribe the terms and conditions of Solid Waste management services, including:

- The nature, location, and level/extent of services;
- The frequency of Collection;
- The means of Collection and transportation;

- The Service Rates and fees; and
- Whether the services are to be provided by means of nonexclusive, partially exclusive, or wholly exclusive franchise, contract, license, permit or otherwise.

County Code Chapter 20.70 authorizes Director to require franchises in any part of the unincorporated territory of COUNTY that is not served by a Garbage Disposal District.

Franchise Development. COUNTY and representatives of the private hauling industry met many times to discuss the scope of services, service specifications, Service Standards, and other Performance Obligations and to address the industry's questions, comments, and concerns.

NOW, THEREFORE, THE PARTIES AGREE AS FOLLOWS:

This CONTRACT applies to all Contract Services, unless specifically indicated otherwise.

SECTION 1 - GRANT OF RIGHTS AND PRIVILEGES

A. Requirements/Grant of Rights

1. Grant of Rights and Privileges

COUNTY grants CONTRACTOR the right and privilege, together with the Performance Obligations, to provide Contract Services.

a. Conditions

- CONTRACTOR is ready, willing, and able to provide Contract Services;
- CONTRACTOR meets all its Performance Obligations,
- No CONTRACTOR Default has occurred as indicated in Part 3 of Exhibit 5; and
- CONTRACTOR fully and timely pays applicable Franchise Fees

b. CONTRACTOR Acceptance

CONTRACTOR accepts these rights and privileges together with Performance Obligations, subject to all terms and conditions in this CONTRACT and the exclusions in subsections B (Exclusions from Service) and C (Exceptions from Exclusivity) of this Section.

2. Grant of Exclusive Franchise for Collection Services

COUNTY grants to CONTRACTOR and CONTRACTOR accepts the exclusive right and privilege to provide Contract Services in accordance with its Performance Obligations, by making independent arrangements with County Commercial Franchise Customers as defined in item A1 of Exhibit 3A1, Collection may be primarily in Dumpster Containers, but may also include Carts and Roll-offs (excluding C&D) within the Service Area awarded to the CONTRACTOR as specified in this CONTRACT subject to all the terms and conditions in this CONTRACT and the exclusions in subsections B (Exclusions from Service) and C (Exceptions from Exclusivity) of this Section.

If a city annexes any portion of the Service Area, COUNTY shall replace the maps of the Service Area in item A1 of Exhibit 16 with new maps that reflect deletion of the annexed area on the date that the annexation becomes effective.

B. Exclusions from Service

Notwithstanding any provision to the contrary contained herein, the following are excluded from the right and privilege granted to CONTRACTOR under this Contract:

1. Solid Waste to be Self-Hauled

This CONTRACT excludes the right and privilege that CONTRACTOR Collect, transport, and Divert/Dispose Solid Waste that Persons Self-Haul. Anyone, including Persons performing services other than MSW Management Services (such as roofers and gardeners) at those Premises, may Collect in receptacles other than Container provided by CONTRACTOR, transport in their own Vehicles, and themselves Dispose of some or all the Solid Waste generated at those Premises.

2. Donation or Selling of Solid Waste or Edible Food

This CONTRACT excludes the right and privilege to Collect any Solid Waste materials or Edible Food that Occupant/Customer donates or sells to Persons other than CONTRACTOR.

3. Organic Waste Onsite Management

This CONTRACT excludes the right and privilege to Collect Organic Waste that Occupant manages on the site where it is generated, such as onsite Composting.

4. Micro-Haulers

This CONTRACT excludes the right and privilege to Collect Organic Waste that Occupant provides to COUNTY approved/contracted Micro-Hauler. The COUNTY allows Customers to utilize Micro-Haulers to Collect, transport, and Divert part or all their Organic Waste that they generate, including but not limited to the Collection of Manure, landscaping, and Food Waste.

Customers serviced by the Micro-Hauler will be transferred into the CONTRACTOR's franchise system if their weekly service level increases to more than the allowable service level under a Micro-Hauler of one 64-gallon Container of Organic Waste per week. The CONTRACTOR shall work with Micro-Haulers to transfer large Organic accounts into the franchise system when the Customers are located within their Service Area(s).

5. COUNTY and Third-Party Agencies

This CONTRACT excludes the right and privilege to provide Collection Services to Premises owned or controlled by any of the following entities:

- COUNTY or any other entity governed by the Board of Supervisors;
- State of California;

- Federal government;
- Any city;
- Any public-school district;

This CONTRACT does not prohibit CONTRACTOR from executing separate contracts with those entities to provide MSW Management Services.

If CONTRACTOR provides such services to any of the entities described above, CONTRACTOR shall report to COUNTY and include it in their Customer list report as indicated in item A1 of Section 10.

Additionally, the CONTRACTOR will not be required to pay the COUNTY any Franchise Fees for these Customers.

CONTRACTOR's failure to comply with any of the requirements of this Section may result in Liquidated Damages, in accordance with Exhibit 12-D2 Liquidated Damages.

6. Residential and Multifamily Premises with Carts Services

This CONTRACT excludes the right and privilege to provide Collection Services to Residential and Multifamily Premises (4 Units or Less) that receive services under an exclusive franchise awarded by the COUNTY for Cart service (such as an Exclusive Residential Franchise Contract for Provision of Refuse, Recyclables, and Green Waste Automated Cart Services at Residential Premises and Certain Multifamily Premises) which includes some mobile home parks. Additionally, the Director in its sole discretion may assign an Authorized Residential Franchise Waste Hauler to provide service to Multifamily Premises (5 Units or More) that have Carts service per individual unit and no Dumpsters.

However, this provision does not apply to Residential Premises who operate a business and utilize Carts for Collection Services. The Director may assign the Authorized Commercial Franchise Waste Hauler to provide service to these Customers.

Residential Customers with Carts and a business can be serviced by the Authorized Commercial Franchise Waste Hauler with Director approval.

7. Garbage Disposal District

This CONTRACT excludes the right and privilege to provide Collection Services to Premises that include Residential, Multifamily, and Commercial properties in a Garbage Disposal District. Garbage Disposal Districts are not included in the Service Area.

8. Non-Exclusive Commercial Franchise Customers

This CONTRACT excludes the right and privilege to provide Collection Services to Premises located in the Acton, Agua Dulce, and Antelope Valley (AV) areas, which shall remain under the non-exclusive commercial franchise system. The Acton, Agua Dulce, and AV areas are not included in the Service Area maps.

Additionally, this CONTRACT excludes the right and privilege to provide Collection Services to NBC Universal studios and their temporary shooting locations (off-site filming locations), which shall remain under the non-exclusive commercial franchise system.

9. Material Exceptions

The following types of materials are not subject to this CONTRACT and shall be designated as exempt materials. These exempt materials may be Collected and taken to a licensed Disposal site or Recycling facility by the Customer or Occupant of the Premises, or their agent, at the owner's or Occupant's expense, in accordance with COUNTY policy and Municipal Code requirements, with the exception of Construction and Demolition (C&D) Debris, which must be handled by a permitted waste hauler subject to requirements in County Code Chapter 20.87. Exempt materials include:

- Medical Waste
- Hazardous Waste
- Radioactive Waste
- Pharmaceutical Waste
- Construction and Demolition (C&D) Debris

10. Unauthorized Collectors

CONTRACTOR acknowledges and agrees that the COUNTY may permit other Persons besides CONTRACTOR to Collect any and all types of materials excluded from the scope of this CONTRACT, as set forth above, without seeking or obtaining approval of CONTRACTOR.

If CONTRACTOR can produce evidence that other Persons are servicing Collection Containers or are Collecting and transporting Solid Waste in a manner that is not consistent with this CONTRACT or the County Code, it shall report as indicated under item A3 of Section 10.

11. Rights Under California Public Resources Code Section 49520

a. *Exclusion*

This CONTRACT excludes the right and privilege for providing Contract Services with any Person who is receiving Solid Waste handling services from a Solid Waste enterprise that has the

statutory right to continue to provide Solid Waste handling services to that Person under PRC Section 49520 *et seq.*

b. Acknowledgements Regarding Statutory Rights

CONTRACTOR acknowledges:

(1) *No Statutory Rights*

CONTRACTOR affirms that it does not have any statutory rights under PRC Section 49520 *et seq.* that arise from providing services under this CONTRACT. This affirmation is not a relinquishment of any rights because no statutory rights exist.

(2) *Expired Term*

This CONTRACT is an exclusive franchise.

Upon expiration of this CONTRACT, no unexpired Term will remain. CONTRACTOR will have no right to continue providing Contract Services, MSW Management Services, or Solid Waste handling services under PRC Section 49520 *et seq.*

(3) *Terminated CONTRACT*

If COUNTY exercises its remedy to terminate this CONTRACT for CONTRACTOR fault, CONTRACTOR will have no right to continue providing Contract Services, MSW Management Services, or Solid Waste handling services under PRC Section 49520.

(4) *Contract Claims*

CONTRACTOR does not have the right to make any claim under PRC Section 49520, but only under this CONTRACT.

c. Stop Contract Services / Procure New Services

In accordance with PRC Section 49523, based on the mutually satisfactory terms of providing Collection Services set forth in this CONTRACT and receipt of compensation therefore, upon expiration or termination of this CONTRACT, CONTRACTOR shall stop providing Contract Services even if the expiration or termination occurs before the end of the period described in PRC Section 49520. In advance of, or upon expiration or termination of this CONTRACT, COUNTY may acquire one or more agreements for MSW Management Services with CONTRACTOR or other

Persons. Those agreements may be exclusive, partially exclusive, or wholly exclusive franchises, contracts, licenses, permits or otherwise, with or without competitive bidding.

CONTRACTOR Obligations Applicable to all Exclusions from Service

CONTRACTOR shall report to the COUNTY and maintain a record of all Customers located within their Service Area that qualify for exclusion of services such as Customers that Self-Haul or self-manage Organic Waste. Upon determining a Customer is Self-Hauling or self-managing their Organic Waste, the CONTRACTOR shall provide a written notice to the Customer informing them that they must register with the COUNTY as a Customer that Self-Hauls or self-manages Organic Waste, as applicable. The CONTRACTOR shall provide the written notice that is developed by the COUNTY.

C. Exceptions from Exclusivity

1. Emergency Services

This CONTRACT is not exclusive in regard to Collection of Solid Waste during emergencies, as described in Section 11. Under this Section, CONTRACTOR may be requested to perform work in other COUNTY Franchise areas, Garbage Disposal Districts, cities, or Counties. Likewise, other waste haulers may be requested to provide Solid Waste services within this Service Area. Service shall be provided at the same rate as the Customer Base Rates for Businesses. See Commercial Service Rates Schedule in Exhibit 7, Attachment 7-2.

2. Collection of Manure in Dumpsters at Residential Premises

This CONTRACT is not exclusive in regard to Collection, transportation, and Disposal/Diversion of Manure in Dumpsters discarded by either the Commercial Franchise or Residential Franchise Customers. Residential Customers that request Manure Dumpsters have the option to select Collection Services from either an Authorized Exclusive Commercial Franchise Waste Hauler or an Authorized Residential Franchise Waste Hauler. This applies to Manure-only Dumpsters for Residential Customers.

3. Collection of Construction and Demolition (C&D) Debris

This CONTRACT is not exclusive in regard to Collection, transportation, and Disposal/Diversion of Construction and Demolition Debris. Construction and Demolition Debris must be handled in accordance with the requirements in County Code Chapter 20.87 and by a hauler with all appropriate Public Health permits. Customers have the option to select any properly permitted Construction and Demolition Debris waste hauler as long

as the selected waste hauler has an agreement with the COUNTY to haul Construction and Demolition Debris.

D. Fees to COUNTY

In consideration for exclusive franchise rights granted under this CONTRACT, CONTRACTOR shall pay COUNTY the Franchise Fee at the time and in the amount and manner established from time to time by COUNTY ordinance or resolution of the Board of Supervisors. CONTRACTOR shall not separately identify the Franchise Fee in correspondence with Customers, including in Terms and Conditions, bills, or invoices.

CONTRACTOR acknowledges the following:

- The franchise fee is a consideration for the County's direct and indirect costs and expenses associated with the franchise rights granted under the Agreement.
- The elimination of competition with private persons for Contract Services under this exclusive franchise has significant monetary value to CONTRACTOR, and the franchise fee is consideration for that exclusivity.
- The franchise fee is a cost of doing business, like capital, fuel and labor costs.
- Paying COUNTY the franchise fee is an obligation of CONTRACTOR and not an obligation of Customers.

E. Ownership of Solid Waste

This CONTRACT does not purport to grant CONTRACTOR ownership over Solid Waste. The right to possession or ownership of Solid Waste placed at the Set-Out Site for Collection, Organic Waste (including Green Waste and Food Waste), Recyclables, and E-waste, will be determined in accordance with existing law and is not affected by this CONTRACT. COUNTY acknowledges that it has no ownership rights in Solid Waste and that CONTRACTOR may provide for transfer of ownership in the Terms and Conditions.

The COUNTY makes no representations or warranties with respect to content of Solid Waste, any Solid Waste Disposal characterization study, or projections by Solid Waste material type. COUNTY expressly disclaims any representations and warranties, either express or implied, as to the merchantability or condition of Solid Waste for any purpose.

CONTRACTOR will not make any claim against the COUNTY based on any estimates, statements or interpretations made by any officer, employee, agent, or consultant of the COUNTY in connection with the procurement of this CONTRACT, including the COUNTY's Request for Proposals, which differ from the actual under this Franchise.

SECTION 2 - TERM OF CONTRACT

A. Term of Contract Services

This CONTRACT is effective and binding on the Execution Date. It expires on the Expiration Date. Certain Performance Obligations survive expiration or termination of this CONTRACT under subsection B below.

“Commencement Date” is the first date of service: October 1, 2022.

“Term” is the period beginning on the Execution Date and ending on the Expiration Date.

“Execution Date” is the date both COUNTY and CONTRACTOR mutually sign this CONTRACT.

“Expiration Date” is any of the following days, as may be extended described in the following subsection A1 of this Section:

- September 30, 2032, or
- As earlier date that the Contract terminates in accordance with Part 6D of Exhibit 5.

1. Extensions of the CONTRACT Term

Director shall have the sole option to extend the initial Term of this CONTRACT under the following subsections A2, A3, and A4. CONTRACTOR may submit a request to the Director to not extend the Term of this CONTRACT. In such an event, the Director shall consider CONTRACTOR’s request and afford substantial weight in its decision to extend the term.

2. Three, 3-Year Extensions

Director may, in his sole discretion, extend the Term of this CONTRACT for up to three additional three-year periods.

3. Six, 1-Month Extensions

Director may, extend the Term of this CONTRACT up to six times, each time in an increment of one to 6 months for a total of no more than 6 months. For example, the Director may first extend the Term for 3 months, subsequently extend it for two more months, and lastly extend it for one more month.

4. Contract Extension Cumulative

The contract extensions are cumulative and may be exercised in any order. For example, after the end of the initial Term, Director may issue three 3-year extensions, one 3-month extension, followed by one 1-month extensions.

5. Transition to Next Waste Hauler

Certain obligations of CONTRACTOR survive the termination of this CONTRACT as provided under subsection B6 below.

6. Notification to CONTRACTOR

Director may notify CONTRACTOR of the intent to extend this CONTRACT no later than the following:

- 90 calendar days before a 3-year extension begins and 30 calendar days before an extension of any monthly duration.

B. Obligations Upon Expiration or Termination of CONTRACT

The following provisions will survive the expiration or termination of this CONTRACT:

1. Acknowledgements

All acknowledgments, including those in the following Sections:

- Item B of Section 1 (inapplicability of PRC 49520)
- Item C of Section 2 (no recovery of undepreciated asset value)
- Item A of Section 3 (no COUNTY responsibility for supervising or performing Collection Services)
- Item A of Section 9 (Record maintenance)
- Part 6 of Exhibit 5 (interpretation of this CONTRACT)

2. Representations and Warranties

All representations and warranties, including those made in accordance with the following Sections:

- Part 6 of Exhibit 5 with respect to review of this CONTRACT
- Item B of Section 14, Authority to Execute
- Attachment 5-8H, CONTRACTOR's Representations and Warranties

3. Indemnities

All Indemnities.

4. Payments

All obligations to pay any due and payable monetary amounts or requests for those amounts, including:

- Payment of Transfer Deposits and Transfer Costs
- Damages under item D of Section 12
- Refund due to Customers that pay Customer Service Rates in advance of Customer Service
- Any Franchise Fees

5. Records and Reports

All obligations to maintain and submit Records and Reports, including:

- The final Annual Report
- Information with respect to Solid Waste Facilities
- Copies of certificates of insurance or other evidence of coverage
- Records of Disposal
- Notice of Destruction of Records of Disposal
- Inspection and audit
- Copies of education and outreach completed
- Records of Non-Collection Notices including supporting documentation

6. Provisions Surviving Expiration Date

Any other provisions of this CONTRACT and rights and obligations of the Parties stated to survive the Expiration Date, including:

- This subsection B6 (cooperation during transition; removal of Containers), and
- Subsection C (no recovery of undepreciated asset value).

a. Cooperation During Transition

If CONTRACTOR is not awarded a new CONTRACT to allow CONTRACTOR to continue to provide MSW Management Services substantially similar to Contract Services in this Service Area after the expiration or termination of this CONTRACT, CONTRACTOR shall cooperate fully with Director and the succeeding contractor, licensee, permittee, or other provider of MSW Management Services to assure a smooth, efficient, orderly, timely, and effective transition.

b. Transfer or Removal of Containers

(1) If County Exercises Container and/or Cart Lids Purchase Options

If upon expiration or termination of this Collection CONTRACT the COUNTY purchases any or all Containers and Cart lids under item C10 of Exhibit 3A1, CONTRACTOR will transfer ownership of those Containers and Carts to COUNTY with documentation satisfactory to COUNTY no later than 7 days after the expiration or termination.

(2) If County Does Not Exercise Container and/or Cart Lids Purchase Options

If upon expiration or termination of this Collection CONTRACT the COUNTY does *not* purchase any or all Containers and Cart lids under item C10 of Exhibit 3A1, then the CONTRACTOR will remove remaining Containers on COUNTY request no later than the following dates:

(a) The date Customers receive replacement Containers,

or

(b) 2 months after the expiration or termination of this Collection CONTRACT.

7. Container Purchase Option

COUNTY may purchase Containers as specified in item C10 of Exhibit 3A1.

C. Undepreciated Assets

If any of CONTRACTOR's Service Assets remain undepreciated upon the expiration or earlier termination by COUNTY of this CONTRACT, CONTRACTOR has no right to recover amounts equal to the undepreciated asset value from COUNTY or Customers, and neither COUNTY nor Customers are obligated to compensate CONTRACTOR for any undepreciated asset value.

CONTRACTOR acknowledges that when exercising its option to extend the Expiration Date, COUNTY need not consider whether any Service Assets are not fully depreciated as of the Expiration Date, and that CONTRACTOR invested in and depreciated those Service Assets in CONTRACTOR's sole discretion.

SECTION 3 - SCOPE OF SERVICES AND SPECIFICATIONS

A. Prescribed Scope

1. Collection Services

CONTRACTOR shall provide Contract Services in accordance with Exhibit 3A1 to the following Premises in the Service Area:

- Premises in the Service Area that were (1) receiving service up to the Execution Date from a non-exclusive Franchisee under a COUNTY Franchise for Non-Exclusive Commercial Solid Waste Collection Services, and (2) included in CONTRACTOR's franchise grant under this Collection CONTRACT, such as Commercial Premises, *unless* and *until* they un-subscribe from Contract Services and
- Upon request, Premises in the Service Area that are (1) not receiving Solid Waste handling services on the Execution Date but (2) are included in CONTRACTOR's franchise grant under this Collection CONTRACT, including Commercial Premises, and (3) subscribe to Contract Services.

2. General

Contract Services include providing Goods, Services, and Property necessary to meet Performance Obligations, including:

- Labor and supervision;
- Software and hardware, including Records of Customer subscription and complaints, billing, and routing, and system utilized by Director to track Collection Services;
- Leases; subleases; installment purchase agreements, including with respect to Vehicles and Carts;
- Equipment, including Vehicles, Carts, or other Containers (such as for special events);
- Supplies; such as plastic bags and cardboard boxes for community cleanup projects and/or special events.
- Insurance, bonds, or other performance security if the insurer, surety, or another provider is an Affiliate or a captive of CONTRACTOR or any Affiliate;
- Maintenance and Office-administration facilities, and their contents,
- Legal, risk management, general, and administrative services.

CONTRACTOR must provide Contract Services in accordance with Service Specifications and Service Standards. Nevertheless, CONTRACTOR has the freedom and discretion to determine the means, manner, or method of providing Contract Services.

CONTRACTOR acknowledges that in entering into this CONTRACT, COUNTY is not responsible for supervising CONTRACTOR or for performance of any Contract Services.

CONTRACTOR shall choose the Solid Waste Facilities, unless otherwise directed by COUNTY as referenced in item D of Exhibit 3A1. In addition, COUNTY is not the owner or titleholder of any material Collected, transported, Disposed of, or otherwise handled by CONTRACTOR.

Any work performed outside the Performance Specifications without Director's prior written approval will be deemed to be a gratuitous effort by CONTRACTOR. CONTRACTOR shall have no claim against COUNTY for any consequential or related liabilities.

B. Change in Scope of Services

1. Collection Services

Director may change the scope of Collection Services and Service Standards in accordance with Part 5 of Exhibit 5, subject to any adjustment in the Customer Service Rates in accordance with item A of Section 7.

2. Service Area Boundary

The Director may adjust Service Area boundaries to account for new development near the Service Area. CONTRACTOR may request a Rate Adjustment only if a boundary results in greater than 10% change of the Service Area's total weekly service level or if such adjustment otherwise impacts CONTRACTOR's costs or expenses in providing the Collection Services under this CONTRACT.

C. Vehicles

1. General

CONTRACTOR shall use Vehicles of appropriate numbers, sizes, capacities, and functions required for the efficient Collection of different types of Solid Waste, such as Refuse, Recyclables, Organic Waste, and Bulky Items. CONTRACTOR shall also provide non-compacting Vehicles for the Collection of E-waste, white goods and any other material that contains chlorofluorocarbons. Vehicles shall be so constructed such that Solid Waste or liquids will not blow, fall, sift, or leak out of the truck into the street. CONTRACTOR shall equip Vehicles with a shovel, broom, and petroleum absorbent agents.

CONTRACTOR shall comply with all local, state and federal Laws, regulations and requirements such as vehicle, engine and fuel standards, including, but not limited to, South Coast Air Quality Management District Rule 1193 and any Laws, rules and regulations superseding it.

CONTRACTOR shall comply with any additional requirement with respect to the Vehicles as set forth in this Section.

2. Alternative Fuel Vehicles

By 2025, all Vehicles used for automated Collection must use Liquid Natural Gas or Compressed Natural Gas fuel, or other alternatives to diesel fuel, as approved by Director unless Contractor Documentation provides otherwise with respect to Collection at Premises that are difficult to serve as described in item L of Exhibit 3A1.

3. Automation

CONTRACTOR shall Collect Refuse, Recyclables, and Organic Waste in automated Collection Vehicles, except CONTRACTOR may Collect the following materials in non-automated Collection Vehicles:

- a. Bulky Items including E-waste**
- b. Holiday trees**
- c. Solid Waste discarded at Set-Out Sites that are Difficult to Service**

4. Renewable Natural Gas (RNG) Procurement

CONTRACTOR shall procure RNG derived from recycled Organic Waste that meets SB 1383 regulations Section 18993.1(h) requirements in the amount of, at least, 25% of their total fuel usage for servicing their Service Area when RNG becomes adequately commercially available for use in California.

CONTRACTOR shall agree that the COUNTY has the sole right to report this RNG procurement towards the COUNTY's fulfilment of its annual recovered Organic Waste product procurement target defined in accordance with 14 CCR Section 18993.1.

CONTRACTOR shall maintain records of all fuel contracts and purchases and provide to COUNTY upon request in addition to fulfilling reporting requirements stipulated under item A2 of Section 10 Reports. CONTRACTOR will be exempt from this requirement if fuel equivalency used for CONTRACTOR's Collection Vehicles exceeds 75% electric. If CONTRACTOR's fuel equivalency used exceeds 75% electric, then

CONTRACTOR's remaining non-electric fuel usage shall be SB 1383 eligible RNG.

CONTRACTOR may propose an alternative procurement plan, as listed in item J4 of Exhibit 3A1, with justification for why RNG procurement is not feasible or reasonable, provided the plan meets the RNG equivalent of 25% total fuel usage and the requirements of SB 1383, Article 12, Section 18993.1(h). Implementation of such plan is subject to COUNTY approval.

5. Extra Vehicles

CONTRACTOR shall maintain enough back-up Vehicles to replace similar types of Vehicles in the event of breakdowns, complaints, and emergencies. Director may specify a minimum number of backup Vehicles.

6. Scales

Within 6 months of Director's request, all automated Collection Vehicles are to have the ability to weigh each Container as it Collects from each Occupant's Set-Out Site. This data is to be connected to each service address and submitted upon Director's request.

7. Vehicle Maintenance

CONTRACTOR shall maintain Vehicles reasonably clean, and in good mechanical condition, and well painted, all to the satisfaction of Director. CONTRACTOR shall maintain Records of inspections and maintenance of all mechanical equipment that CONTRACTOR uses to provide Contract Services, including Vehicles. CONTRACTOR will use Vehicles that are safe to operate, in accordance with the requirements promulgated by COUNTY Department of Public Health, California Highway Patrol, South Coast Air Quality Management District, manufacturer, and all other applicable Federal, State, County, and local laws and regulations. CONTRACTOR shall allow Director to view all inspection and maintenance Records and shall provide Director with those Records upon request.

CONTRACTOR is not required to provide new Vehicles on the Commencement Date or to retire Vehicles of any specified age. However, CONTRACTOR shall not operate Vehicles that repeatedly breakdown or leak. CONTRACTOR shall replace a Vehicle that Director determines to be of unsatisfactory operating condition, such as one that is frequently breaking down and delaying services, leaking fluids, making excessive noise, or exhibiting other significant issues identified by Director.

8. Safety Equipment

All Collection equipment used by CONTRACTOR shall have appropriate safety markings including, but not limited to, highway lighting, flashing and

warning lights, clearance lights, and warning flags. All such safety markings shall be subject to the approval of COUNTY (if different from the markings commonly used by CONTRACTOR) and shall be in accordance with the requirements of the California Vehicle Code, as may be amended from time to time. All Collection Vehicles shall be equipped with audible back-up warning devices.

9. Vehicle List

CONTRACTOR shall use only Vehicles that have been submitted to and approved by the Director. CONTRACTOR shall submit a complete list of Vehicles, including back-up Vehicles, using the applicable reporting form, accessible through LA County's Data Management System and update it as Vehicles change.

10. Vehicle Billboards

CONTRACTOR shall equip automated Collection Vehicles with frames on both sides capable of securing signs measuring approximately 30 inches by 90 inches or another dimension approved by Director. CONTRACTOR shall design, print, and install signs on each frame promoting Recycling of Recyclable materials and Organic materials, Diversion and safe handling of Unpermitted Waste or other topics as requested by Director, with text, graphics, and design approved by Director, up to six times throughout the CONTRACT term. CONTRACTOR shall ensure that the appropriate Director-approved signs are affixed to the Vehicle always. Director reserves the right to interchange any of the six signs up to four times per Contract Year. CONTRACTOR shall not use the billboards for commercial advertising.

11. Vehicle Identification

CONTRACTOR's name or other name, as approved by Director, Vehicle identification number and logo shall appear on all Vehicles.

Collection Vehicle Technology All Vehicles used for Collection Services, shall be equipped with a Global Positioning System (GPS). GPS data will be maintained by CONTRACTOR either directly or through a third-Party service. The GPS shall be able to track a Vehicle's route with lines or dots superimposed on a map.

12. Global Positioning System (GPS)

All Vehicles used for Collection Services, shall be equipped with a Global Positioning System (GPS). GPS data will be maintained by CONTRACTOR either directly or through a third-Party service. The GPS shall be able to track a Vehicle's route with lines or dots superimposed on a map.

The GPS shall gather the following data: date, time, speed, direction, location (address) and shall be able to generate Reports. CONTRACTOR shall retain all data for a minimum of 30 calendar days or other duration approved by Director.

The minimum (ping frequency of occurrence that GPS data is received from the Vehicle) shall be at least every one minute for fully automated Collection and at least every ten seconds for other Collection Vehicles, when within the Service Area.

CONTRACTOR may propose an alternate tracking system or device that results in similar results and data for Director approval.

CONTRACTOR must provide to Director at no additional cost or expense any software or licenses required to view recording or data. Director may request Reports from CONTRACTOR to track the location of Collection Vehicles in real time and to generate Reports as needed. CONTRACTOR shall provide copies of Reports within two business days of receiving Director request. Request may be for a specific time or a geographic location (e.g., between 10:00 a.m. and 11:00 a.m., or 1200 block of Main St.). CONTRACTOR's failure to provide Reports requested by Director within time specified by Director may be considered an admission of fault for the purposes of assessing Liquidated Damages. For example, if CONTRACTOR does not give Director a requested Report, within a period specified by Director, to verify that a Vehicle Collected all Containers on an identified block, Director may assume that CONTRACTOR did not Collect those Containers and assess Liquidated Damages.

SECTION 4 - SERVICE STANDARDS

A. Public Health and Safety; Nuisances

CONTRACTOR shall immediately Report to Director any public health and safety or nuisances listed below.

1. Litter

CONTRACTOR shall immediately clean up all litter it caused. If CONTRACTOR services an over-filled Container where the lid cannot be closed, any litter must be cleaned.

When Collecting any Bulky Items, CONTRACTOR shall also clean up all litter within a 3-foot radius of the site from which CONTRACTOR Collected the Bulky Item. CONTRACTOR shall ensure that each Vehicle is properly staffed and equipped for this purpose.

2. Spills

CONTRACTOR shall enclose or cover Solid Waste that it transports in Vehicles, debris boxes, hoppers, compactors, or any other Containers. CONTRACTOR shall prevent Solid Waste from escaping, dropping, spilling, leaking, blowing, sifting, falling, or scattering from Vehicles ("Spills") during Collection and transportation. CONTRACTOR shall not transfer loads from one Vehicle to another Vehicle unless necessitated by mechanical failure or accidental damage to a Vehicle. CONTRACTOR shall immediately clean up any Spills on any alley, street, or public place.

3. Leaking

CONTRACTOR shall prevent oil, hydraulic fluid, paint, or other liquid from leaking from its Vehicles. CONTRACTOR shall ensure that each Vehicle carries petroleum absorbent agents and other appropriate cleaning agents and if any liquid leaks from a Vehicle, CONTRACTOR shall immediately cover, treat, or remove the liquid materials from the ground, as necessary, and apply the necessary cleaning agent to minimize the adverse impact of the liquid materials.

4. Noise

CONTRACTOR shall conduct Collection as quietly as possible, in compliance with noise levels prescribed by Applicable Law, including County Code Section 12.08.520-Refuse Collection Vehicles. CONTRACTOR shall cause the least possible obstruction and inconvenience to public traffic or disruption to the peace and quiet of the Service Area.

While on Residential streets, CONTRACTOR shall minimize the noise for horses in the Public Right-of-Way. The Collection Vehicle shall park and not operate the Collection arm or compact the load while within 100 feet of a horse that is walking in the Public Right-of-Way.

5. Best Management Practice

CONTRACTOR shall implement the following best management practice. When CONTRACTOR services a Container, CONTRACTOR shall ensure the Container lid is closed prior to returning it back to its designated Set-Out Site.

B. Private Property

CONTRACTOR shall obtain property owner consent to enter private driveways, alleys, streets, and parking lots in cases such as:

1. Private Property

a. Acknowledgements

CONTRACTOR acknowledges the following: Although there may be an implied waiver to access the front of Premises, a written consent may be advisable to access a side or rear yard. Additionally, private streets and driveways may not meet COUNTY's design standards and may not adequately withstand the weight of a Collection Vehicle.

b. Damage to Pavement: Waiver

If CONTRACTOR operates Vehicles on private property, following Director approval, CONTRACTOR may require the property owner to allow CONTRACTOR's entry and waive liability for CONTRACTOR's damage to driveways or other pavement, in a form satisfactory to Director. CONTRACTOR is not obligated to require a waiver. A waiver will not relieve CONTRACTOR of its obligation to repair or replace damaged pavements if it caused the damage by its negligent or willful acts or omissions under Part 9C of Exhibit 5.

c. Personal Injury: Indemnity

If CONTRACTOR enters private property whether in a Vehicle or by foot (for example to provide roll-out service), following Director approval, CONTRACTOR may require the property owner to hold harmless and indemnify CONTRACTOR in form satisfactory to Director. In that event, CONTRACTOR shall also require the property owner to hold harmless and indemnify COUNTY.

d. CONTRACTOR Indemnifies COUNTY

Despite receiving COUNTY approval, CONTRACTOR shall indemnify and hold COUNTY harmless from liabilities related to entering Customers' Premises, whether CONTRACTOR acts in compliance or noncompliance with this Contract. This indemnification is in addition to CONTRACTOR's other Indemnifications.

C. Non-Collection

CONTRACTOR is not obligated to Collect in any of the following events prescribed in item A5 of Exhibit 3A1.

D. Compliance with Civil Rights Law

CONTRACTOR shall comply with Subchapter VI of the Civil Rights Act of 1964, 42 USC Sections 2000 (e)(1) through 2000 (e)(17), to the end that no person shall, on the grounds of race, creed, color, sex, religion, ancestry, age, condition of physical disability, marital status, political affiliation, or national origin, be excluded from participation in, be denied the benefits of, or be otherwise subjected to discrimination under this Contract or under any project, program, or activity supported by this Contract. Contractor shall comply with its EEO Certification (Form PW-7).

E. CONTRACTOR Waste Reduction Practices

Consistent with the Board of Supervisors' policy to reduce the amount of Solid Waste Disposed in landfills within COUNTY, CONTRACTOR shall use best efforts to practice waste reduction and implement procurement policies in providing Contract Services, including maintaining Records. In written correspondence with Customers and Director, CONTRACTOR shall use recycled paper that is labeled to indicate its recycled content.

CONTRACTOR shall offer Customers the option to go paperless by offering them electronic notifications.

F. Customer Correspondence and Other Materials

CONTRACTOR shall submit to Director for approval, written materials CONTRACTOR intends to distribute to Customers at least thirty County Business Days before printing, texting, e-mailing, or mailing the materials.

At Director's request CONTRACTOR shall distribute written information to its Customers and Occupants by including it within CONTRACTOR's mailings or by separate electronic distribution.

G. Publicity and News Media Relations

1. Publicity

Unless otherwise required by subsection F or subsection G.2, CONTRACTOR and its Affiliates, employees, consultants, agents, or subcontractors may, without Director approval, publicize its Contract Services or indicate in its proposals and sales materials that it has been awarded this CONTRACT to provide Contract Services, if CONTRACTOR develops that publicity, proposals, or sales materials in a professional manner.

Neither CONTRACTOR nor any of its Affiliates, employees, consultants, agents, or Subcontractors may publish or disseminate commercial advertisements, news or press releases, opinions or feature articles using the name of COUNTY without the prior written consent of COUNTY's Chief Executive Officer and County Counsel.

2. News Media Relations; Trade Journal Articles

CONTRACTOR shall notify Director by telephone followed by e-mail of all requests for news media interviews related to the Contract Services (and not other communities) within 24 hours of receiving the request. Before responding to requests involving matters other than the Collection programs and scope of Contract Services, CONTRACTOR shall discuss CONTRACTOR's proposed response with Director.

CONTRACTOR shall submit copies of CONTRACTOR's draft news releases or proposed trade journal articles related to Contract Services to Director for prior review and approval at least four County Business Days in advance of release.

CONTRACTOR shall give Director copies of media interviews and news releases related to Contract Services within four County Business Days of their occurrence.

H. Responsiveness to County

CONTRACTOR shall meet the following standards:

1. Normal

Respond to COUNTY communications such as telephone messages, text messages, and e-mails no later than the next COUNTY Business Day. Acknowledge, at a minimum, that the CONTRACTOR has received the communication and provide an estimated time for a full response if the communication's issue cannot be immediately resolved.

2. Emergency Telephone Messages

Respond to any telephone message within one hour in cases of emergencies as required under item J1 of Section 4.

3. Written Correspondence

Respond to written correspondence from Director within one week of receipt.

4. Meetings

Meet with Director during Director's Office Hours within one week of Director's oral or written request at Director's offices or other location requested by Director.

I. No Commingling of Solid Waste

1. No Commingling Between Areas

CONTRACTOR may not commingle, in its Vehicles or otherwise, any Solid Waste that it Collects within the Service Area with any other Solid Waste that it Collects outside the Service Area, without prior written approval from Director.

For example, Director may allow Food Waste to be Collected from multiple jurisdictions to make Collection routes more efficient and therefore more cost effective. Additionally, Director may consider allowing commingling of Solid Waste during emergency situations.

Director may require documentation such as records of Customers, including Container capacities, in cities and in the Service Area, respectively. CONTRACTOR shall maintain Records with respect to Solid Waste Collected in the Service Area separately from records with respect to Solid Waste Collected outside the Service Area, including its weight.

2. No Commingling of Different Materials

CONTRACTOR shall not commingle, in its Vehicles or otherwise, any Solid Waste that it Collects with any other type of Solid Waste that it Collects within the Service Area, without prior written approval from Director, as detailed in item M of this Section and further required in item E4 of Exhibit 3A1. For example, if a Vehicle is on its route Collecting Refuse, it may not Collect Recyclables or Organic Waste until after it has emptied its Refuse load at the approved facility.

J. Key Personnel

CONTRACTOR acknowledges that it identified certain personnel and described their professional experience and qualifications in the proposal it submitted to Director about the procurement of this CONTRACT, and that COUNTY awarded this CONTRACT to CONTRACTOR based in part on those individuals' experience and qualifications. CONTRACTOR shall identify those personnel ("Key Personnel") in Contractor Documentation in Exhibit 17.

CONTRACTOR shall notify Director immediately of changes or upcoming changes in Key Personnel, including the professional experience and qualifications of the individual CONTRACTOR proposes to serve in place of a departing Key Personnel. Director may request CONTRACTOR to propose an alternative individual to serve in the position of the departing Key Personnel.

1. Emergency Telephone Number

CONTRACTOR shall maintain a local emergency telephone number disclosed to Director for use by Director outside CONTRACTOR Office Hours. CONTRACTOR shall make a representative available at the emergency number outside CONTRACTOR Office Hours who will return any emergency call as soon as possible and in any event within one hour.

2. Lead Person

CONTRACTOR shall assign a lead person(s), such as a route supervisor, to this Service Area. The lead person shall be responsible for ensuring that CONTRACTOR meets Performance Obligations. They shall spend as much time as possible in the Service Area. They shall act as a liaison between field crew and Director.

K. Uniforms

CONTRACTOR shall require its field employees to wear uniforms and prohibit them from removing any portions of their uniforms while providing Contract Services. Uniforms must meet the following specifications:

- Bear the CONTRACTOR's name, or other name approved by Director (for example, a DBA instead of a corporate name), and
- CONTRACTOR's logo.

L. Confidentiality

CONTRACTOR shall maintain the confidentiality of all records obtained from Director under this CONTRACT in accordance with all Applicable Law. CONTRACTOR shall inform all its officers, employees, agents, and Subcontractors providing Contract Services of this confidentiality obligation. CONTRACTOR acknowledges that these records may be subject to a Public Records Request made to COUNTY.

M. Single-Pass Collection

CONTRACTOR shall obtain Director's approval prior to implementing single-pass service. "Single-pass service" means that Customers may commingle and discard Refuse, Recyclables, and Organic Waste, and CONTRACTOR may Collect them in the same Container. If CONTRACTOR implements single-pass service, it shall remove or replace the additional Collection Containers designated for Recyclables and Organic Waste from the Customer's Premises.

CONTRACTOR must separate those commingled Solid Waste materials at a High Diversion Organics Waste Processing Facility (HDOWPF) that complies with SB 1383 requirements and Divert them. CONTRACTOR shall maintain weight Records of commingled Solid Waste separately from weight Records of source-separated Solid Waste.

1. Approval

If a Customer requests the single-pass service, CONTRACTOR shall request single-pass service for such Customer(s). CONTRACTOR may request single-pass service on behalf of Customer(s) if they consider Customers would benefit from this service. Requests must be approved by the Director and include the following:

- Proposed Customer(s) address(es), and service level(s)
- Written justification of the total miles of the entire route to provide this service
- Written consent from Customer(s) affected by the single-pass, and
- Notification to Customer(s) residing on the Premises being serviced.

2. Billing Fees

If approved by Director, CONTRACTOR must charge Customers the total cost of providing this service. The billing fees shall be separated into two expense components.

- Disposal/Diversion Expense -This is the expense related to processing all the waste Collected through single-pass. This is the tip fee (\$ per ton) at the HDOWPF multiplied by the total single-pass Tonnage.
- Transportation Expense - This is the added expense related to sending one special truck from CONTRACTOR's yard to the Service Area and then to the HDOWPF. This expense shall be identified as a cost per mile as stipulated in Attachment 7-2, Service Rates of Exhibit 7. At the time of implementation, CONTRACTOR shall provide justification of the total miles of the entire route to implement

the single-pass option. The total expense shall be the cost per mile multiplied by the total miles. The Director may assign differing percentages for distributing this expense among the customers if distance varies greatly to serve one Customer versus the other.

Contractor shall add the Disposal/Diversion Expense and the Transportation/Labor Expense for a total cost of implementation. Rates charged to Customer(s) shall be the total cost of implementation divided by total cubic yards serviced of all Dumpsters and/or Carts within the single-pass option, and then multiplied by each Customer(s) cubic yard single-pass service for their individual rate.

For example:

- 2 large Customers are approved for single-pass service
 - Customer A will have 40 cubic yards service
 - Customer B will have 80 cubic yards service
- CONTRACTOR identifies total tonnage collected is 15 tons (via weigh tickets) and tip fee is \$110/ton = \$1650
- CONTRACTOR identified \$10/mile and total single-pass route is 20 miles = \$200
- Customer A rate = $\$1850/120\text{CY} \times 40\text{CY} = \616.66
- Customer B rate = $\$1850/120\text{CY} \times 80\text{CY} = \1233.33

3. Customer Billing

CONTRACTOR shall invoice single-pass Customers quarterly. CONTRACTOR must ensure they accurately bill Customers for all services provided. CONTRACTOR must provide Customers a 30-day notice prior to changing any billing rates.

N. Professional Manner

The services provided by CONTRACTOR shall be performed in a thorough and professional manner so that all Customers are provided at all times with reliable, courteous and high-quality Solid Waste handling services. To determine what is “professional” COUNTY may consider policies, standards, recommendations and other statements from associations whose members handle Solid Waste, such as the Solid Waste Association of North American (SWANA), the National Waste and Recycling Association, Association of County Engineers.

O. Privacy

1. General

CONTRACTOR shall strictly observe and protect the rights of privacy of Customers and Occupants. CONTRACTOR shall not reveal to a Person other than COUNTY any information identifying individual Customers and Occupants or the composition or contents of a Customer's Solid Waste to any Person unless under Section 9 or upon the authority of Law or upon valid authorization of the Customer. This provision may not be construed to excuse CONTRACTOR from its obligations to assist COUNTY in the preparation of Solid Waste characterization studies or waste stream analyses, keeping Records, making Reports, or assisting COUNTY on meeting Federal, State, and local requirements.

2. Mailing Lists

CONTRACTOR shall not market or distribute mailing lists with the names and addresses of Customers and Occupants.

3. Privacy Rights Cumulative

CONTRACTOR's obligations in this Section are in addition to any other privacy rights accorded Customers and Occupants under Applicable Law.

SECTION 5 - ADDITIONAL CONTRACT PROVISIONS

Exhibit 5 contains additional CONTRACT provisions that are incorporated by reference into the CONTRACT. Exhibit 5 includes the following parts:

- Part 1 General CONTRACT Requirements
- Part 2 Indemnification and Insurance
- Part 3 Suspension; Termination; Debarment Breaches and Defaults
- Part 4 Transfer of CONTRACT
- Part 5 General Provisions
- Part 6 Definitions and Interpretations of CONTRACT
- Part 7 Compliance with Laws and Regulations
- Part 8 Labor-Related Provisions Required in County Contracts

SECTION 6 - CUSTOMER SERVICE

A. Facilities

CONTRACTOR shall maintain both the following:

- A Vehicle maintenance yard, and
- Office at the address provided in Contractor Documentation in Exhibit 17.

CONTRACTOR may change the address by notifying Director in accordance with item A5 of Exhibit 17.

B. Telephone Service

CONTRACTOR shall maintain a toll-free telephone number and meet the following criteria:

1. Office Hours

CONTRACTOR shall provide a customer service representative to personally answer all calls to the toll-free number during CONTRACTOR Office Hours, including calls from Director, Customers, Occupants, and the public.

2. After Hours

CONTRACTOR shall provide an answering machine to answer all calls to the toll-free number outside of CONTRACTOR Office Hours that allows callers to leave messages, such as reporting missed pick-ups and other complaints. CONTRACTOR shall further comply with County Code Section 20.72.160.

3. On Hold Messaging

CONTRACTOR shall use Reasonable Business Efforts to broadcast public education messages while Customers are waiting on hold to talk to a customer service representative.

4. Telephone Tree

CONTRACTOR shall require no more than two recorded options on a telephone tree before the caller speaks to a live customer service representative (for example, English/Spanish and residential/commercial service choices).

5. Answer Speed

CONTRACTOR shall use Reasonable Business Efforts to answer the telephone within four rings. CONTRACTOR shall answer 90 percent of all calls within the first 4 rings.

CONTRACTOR shall not leave the Customer on hold for more than ten minutes.

If Director determines that CONTRACTOR does not meet these Service Standards, Director may require that CONTRACTOR install additional telephone lines, hire additional customer service representatives, and make other customer service improvements without increasing Service Fees. Their determination will be based on whether the CONTRACTOR answers calls:

- Within five rings, based on at least three calls within one week, or
- 10 calls within one month.

6. Bilingual

CONTRACTOR shall respond to Customers and Occupants in English or Spanish as requested by the Customer or Occupant. Director may also require reasonable access to other languages such as through a translation service.

7. Knowledgeable Staff

CONTRACTOR shall provide customer service representatives with a knowledge of basic services in the CONTRACT. A supervisor with extensive CONTRACT knowledge is to be available to respond to questions or concerns by callers.

A representative answering a regional or nation-wide hotline with no CONTRACT specific training is not acceptable. Also, calling someone back after researching the correct answer is acceptable but providing the wrong information due to a lack of adequate training is not acceptable.

C. Paperless/Electronic Information and Services

1. Website

CONTRACTOR shall develop and maintain a website that includes the following information and Service options:

a. *Service Information*

Information such as Terms and Conditions form or service information, service brochures, newsletters, FAQ's, Holiday schedules, Christmas tree pick-up information, service changes, invoice explanations, allowable and forbidden discards, list of Recyclable and Organic materials, educational and outreach materials, notifications, alerts, and other information requested by Director.

b. *Bill Payment*

The ability for Customers to review and pay their bills online for all Collection Services including Extra Services Fees as referenced under item B3 of Section 7.

c. *Service Requests*

Requests for service Collection that is not regularly scheduled, including on-call Bulky Item Collections, requests for extra pickups, and service cancellations.

d. *Contact Us*

CONTRACTOR's contact information where Customers can register complaints and follow-up on complaint resolution.

e. *Link*

COUNTY may direct CONTRACTOR to add a link to Director's websites, such as but not limited to CleanLA.com, Smartbusiness.com and FoodDROPLA.com.

2. Paperless/Electronic Notifications

To reduce paper waste and reach more readers, CONTRACTOR shall offer their Customers the option to receive information via electronic notification. Information to be included in the electronic notification may include:

- Receiving service information described in preceding item C1a electronically, subsequently switching back to paper;
- Electronic billing under preceding item C1b;
- Making service requests under preceding item C1c; and
- Contacting CONTRACTOR under preceding item C1d.

CONTRACTOR shall give all educational messages and the template for service messages to Director for approval prior to sending to Customers. Upon Director's request, CONTRACTOR shall send messages provided by Director.

3. E-mail Address

CONTRACTOR shall maintain an e-mail address for use by Customers and Occupants and provide to Director upon request.

D. Responses to Customer Complaints and Other Correspondence

1. Resolution of Complaints

CONTRACTOR shall investigate all Customer and Occupant complaints including but not limited to service complaints such as missed pick-ups, customer billing and complaints related to non-compliance of SB 1383 requirements.

b. Call/E-mail for Service

CONTRACTOR shall maintain an e-mail address under preceding subsection C3 and telephone service under subsection B of this Section.

A call or e-mail from a Customer or Occupant to request a service or report an issue, such as a damaged container, is not considered a complaint.

c. First Complaint

CONTRACTOR shall address all Customer and Occupant complaints immediately and resolve them by the end of the next Service Day following Customer or Occupant contact or any reasonable time agreed upon between Customer or Occupant and CONTRACTOR. A Customer or Occupant should not have to call or e-mail to complain on the same issue because CONTRACTOR did not resolve it as previously committed by CONTRACTOR, such as a damaged Container was not repaired or replaced as committed.

d. Second and Subsequent Complaints

A Customer or Occupant should never have to call or e-mail to complain a second time on the same issue because CONTRACTOR did not resolve it as previously committed by CONTRACTOR.

e. Investigation of SB 1383 Regulatory Non-Compliance Complaints

The CONTRACTOR shall investigate any SB 1383 Regulatory Non-Compliance Complaints within their Service Area in efforts to assist the COUNTY in meeting the 90-day compliance deadline as stipulated in SB 1383 Regulations (14 CCR Section 18995.3(c)).

Upon CONTRACTOR completion of the investigation, the CONTRACTOR shall submit an investigation report that documents the investigation performed and shall recommend to the COUNTY on whether or not the entity investigated is in violation of SB 1383 based on the CONTRACTOR's investigation. The COUNTY shall make a final determination of the allegations against the entity.

2. Communications Log

CONTRACTOR shall enter, log, and maintain Records of all communications and their resolution, in computerized format and in compliance with County Code Section 20.72.160. CONTRACTOR shall maintain that log. CONTRACTOR shall submit the log for the applicable quarter to Director with CONTRACTOR's Quarterly Report under item A1 of Section 10.

3. County's Reimbursement Costs

If COUNTY employees or their contractors spend more than either of the following times resolving Customer complaints, then CONTRACTOR shall reimburse COUNTY its Reimbursement Costs that COUNTY incurred to resolve the complaint:

- Two hours in the aggregate resolving complaints from any single Customer that the Customer states have previously been filed with CONTRACTOR, or
- More than one hour in any work week (Monday through Friday) resolving complaints from different Customers.

The invoice for Reimbursement Costs should include all the following information:

- The address of the Premises being serviced,
- Customer who complained,
- Nature of complaint,
- Amount of time spent,
- Costs, including hourly fees for employees, agents or contractors who addressed the complaints, and
- Expenses, including phone and postage costs.

E. Service Interruption

CONTRACTOR shall monitor the Public Works Road Closure website (<http://pw.lacounty.gov/roadclosures/>) for conditions that may cause service interruptions. CONTRACTOR shall not alter or interrupt its service schedule without Director approval.

CONTRACTOR shall alert all Customers and Occupants of any Director-approved interruption in service and when service will resume. CONTRACTOR may use any type of communication, including phone blast, e-mail blast, and text messaging. Examples of interruption include various reasons, such as road closures, extreme weather conditions, or breakdown of CONTRACTOR equipment.

F. Responsiveness to Customer

Respond to communications such as telephone messages, text messages, and e-mails to the source that made contact no later than the next business day. If CONTRACTOR is unable to directly address the issue, CONTRACTOR shall respond with an acknowledgement to confirm receipt of message and indicate when the issue will be addressed.

Respond to United States Postal Service, Federal Express, or other courier provided correspondence from Customers or Occupants within one week of receipt.

G. Setting Up or Terminating Service

1. New Customers

- Obtain contact and service location information
- Explain services and charges
- Provide Customer Subscription Order form, Bill of Rights, most recent Bi-annual newsletter
- Mail brochure
- Offer Bulky Item Collection upon move-in/out
- Offer paperless/electronic notifications
- Deliver Containers
- Explain Organic Waste Diversion requirements and offer on-site training

2. Terminating Service

CONTRACTOR shall give each Customer the option to terminate its terms and conditions without cause on 14-days' Notice. CONTRACTOR shall refund any advanced payment for service after termination. CONTRACTOR shall notify COUNTY immediately upon Customer request to terminate.

Additionally, upon Customer request to terminate Collection Services the CONTRACTOR must complete the following:

- Offer Bulky Item Collection
- Explain what to do with Containers
- Explain refund procedure for any prepaid services

H. No Evergreen

CONTRACTOR shall not include in the terms of Customer Subscription Orders or other service contract with its Customers any automatic renewals or extensions, colloquially referred to as "evergreen" clauses, which obligate a Customer to take affirmative, prescribed action in order to terminate the Customer Subscription Order (such as giving written notice within a specified time period before the stated expiration of the Customer Subscription Order).

I. Term Limitation

CONTRACTOR shall limit the terms of Customer Subscription Orders to no longer than the remaining term of this CONTRACT.

J. No Charges

CONTRACTOR shall not impose a charge on a Customer that terminates Collection Services with or without cause, including Liquidated Damages, penalties, or removal fees for any Carts, Dumpsters or Roll-off Containers.

SECTION 7 - SERVICE RATES AND BILLING

A. Customer Service Rates

The CONTRACTOR shall bill all Customers at rates not to exceed those specified In Attachment 7-2, of Exhibit 7 Service Rates. The CONTRACTOR shall be solely responsible for providing accurate billing statements and collecting billing payments from Customers. Billing shall be performed on the basis of services rendered, including the minimum base rate (includes Refuse, Recyclables, and Organic Waste) and Extra Services Fees, as applicable. COUNTY is not liable for paying any Customer's invoices, including delinquencies and surcharges relating to contamination.

CONTRACTOR shall charge Customers accordingly as stipulated in Attachment 7-2 Service Rates of Exhibit 7, meaning Commercial Business, Multifamily, and Residential Customers will each have distinct Service Rates.

1. Uniform Rates

CONTRACTOR shall charge Customers the same, uniform Customer Service Rates for the same Collection Services listed in Attachment 7-2, Service Rates of Exhibit 7. For example, one Customer should not be charged \$10 for Scout Service while another Customer is charged \$8.

2. Base Rate

The Minimum Default Collection Service includes a minimum base rate for the Collection of Refuse which is agreed upon by the Customer and includes an automatic subscription of a 96-gallon Cart for Recyclables and a 64-gallon cart for Organic Waste at no additional charge, Collected once per week. Additional service days and additional size Containers beyond the minimum base rate shall be charged according to the Service Rates Schedule listed in Attachment 7-2 of Exhibit 7.

3. Extra Services Fees

The CONTRACTOR shall charge Customers accordingly for additional services as listed in Exhibit 7, Extra Services Fees to Customers. Maximum rates shall not go beyond what is specified. Some additional services include scout service, container locks, contamination fees, and additional Bulky Item pickups. See full list in Exhibit 7, Attachment 7-2, Extra Services Fees.

4. Roll-offs and Compactors

Refuse, Recyclables and Organic Waste Collected in Roll-off Containers and compactors shall be billed to the Customer at the rates specified in Attachment 7-2 of Exhibit 7, Service Rates Schedule. Rates included are specified for temporary and permanent Roll-offs and compactors.

CONTRACTOR may provide Roll-off Containers for Construction and Demolition Debris. CONTRACTOR shall charge the Customer as indicated in Attachment 7-2 of Exhibit 7, Extra Services Fees.

5. Rates for Customers with Waivers and Exemption

CONTRACTOR shall charge the Customers with the discounted rates as set forth in Attachment 7-2 of Exhibit 7, for any Customers that have been granted any waivers and/or exemptions by the COUNTY as referenced in item B of Section 1.

CONTRACTOR shall ensure that accurate Records are maintained for such waivers and exemptions and Customers are billed properly.

6. Senior Discount

CONTRACTOR shall discount the Customer's Basic Service Rate by 25 percent applied to Elderly Customers at Residential Premises such as:

(a) Residential Customers who have Dumpster Collection Services for Refuse and meet the following requirements:

(1) 62 or Older

The Customer is age 62 or older as evidenced by a driver's license or other document issued by a governmental entity.

(2) Head of Household

The Customer is a head of household as evidenced by his or her name on utility or telephone bills for the involved premises.

(3) Life-Line or Low Refuse Generator

The Customer either: (a) qualifies for discounted utility rates based on financial need (such as those referred to as "life-line" rates) as evidenced by water, power, or telephone bill for the involved premises, or (b) generates small amounts of waste and for Refuse uses only one 32-gallon Cart.

7. Rate Adjustments

Initial Service Rates are set based on the maximum rates proposed in the Exhibit 7 of Attachment 7-2, Service Rates Schedule. The Service Rates will thereafter be adjusted using the Consumer Price Index (CPI) for Trash and Garbage Collection (CUUR0000SEHG02), as described in Exhibit 7, Rate Adjustments. The first Rate Adjustment will be effective July 1, 2023.

B. Customer Invoice and Payment

1. Invoice Content

CONTRACTOR shall include in its Customer invoice the following information:

a. Contact Information

CONTRACTOR's telephone number, Office address, website and e-mail address for Customer complaints and questions.

b. Itemized Costs

Itemize costs in accordance with services. CONTRACTOR shall not identify that portion of a Customer's invoice attributable to a Franchise Fee, if any.

c. Paperless Option

A message promoting its website-based invoicing and payment system on all paper invoices sent to Customers.

At Director's request, CONTRACTOR shall promptly submit a copy of a Customer's invoice to Director.

2. Frequency

CONTRACTOR shall invoice all Customers monthly, or an alternate frequency as approved by Director. Additionally, CONTRACTOR shall invoice single-pass Customers quarterly as set forth in item M of Section 4, Single-Pass Collection.

Collection Services including any surcharges are to be billed to all Customers one month in advance. Bills shall be sent on or before the first day of the billing period. Payment in full is due no later than the last day of the month.

If Customer fails to pay bill, see item B7 of this Section for actions to be taken.

3. Electronic Invoicing

To reduce paper waste, CONTRACTOR shall make available and encourage to all Customers an electronic invoicing system at no additional charge. CONTRACTOR shall ensure that the electronic invoicing and payment website conforms to industry-standard practices for electronic commerce security. CONTRACTOR must ensure that these Customers receive invoice inserts such as newsletters either electronically or paper copies, as requested by Customer. Through CONTRACTOR's website, Customers may request to cease paper invoices and receive all invoices through e-mail or access them on CONTRACTOR's website.

4. Inserts

At Director's request, CONTRACTOR shall include a message and/or enclose with Customer's invoice all inserts prepared and provided by Director.

5. Electronic Payment

CONTRACTOR shall make available and encourage to all Customers an electronic payment system at no additional charge. This system will be website based and allow Customers to pay invoices through CONTRACTOR's website, both one-time and reoccurring. CONTRACTOR must allow credit card payments and may include direct bank routing or other payment methods.

6. Refunds

CONTRACTOR shall refund any overcharges to a Customer (including advance payments for Collection Services that are subsequently canceled) within 30 days after collection thereof. CONTRACTOR shall pay the Customer interest on overcharges (other than advance payments for subsequently canceled services) with interest thereon at ten percent per annum from the date originally overcharged until the date refunded.

7. Late Payment

Customer payment of bills are due to CONTRACTOR no later than the last day of the billed month. The following are the required warning notices and maximum allowable penalties for late payment. CONTRACTOR may be more lenient.

If payment is not received after 1.5 months, a reminder shall be sent to Customer indicating missed payment, balance due, and warning of ten percent late fee. If payment is not received by the last day of the second month, the account will become delinquent, and an additional ten percent fee may be added to the balance. If payment is not received after 2.5 months, a second reminder shall be sent to Customer indicating missed payment, balance due including ten percent late fee, and warning of stopping service

and Container removal. CONTRACTOR must provide Non-Collection Notice to Occupants as indicated in item A5 subsection a8, of Exhibit 3A1. If payment is not received after 3 months, Collection Service may be stopped. If payment is not received after 3.5 months, Collection Services may be interrupted by removing the Containers from the Premises and a \$25 interruption fee may be charged upon returning Containers to Premises. CONTRACTOR is to abide by any trespassing laws while removing Containers.

If Customer fails only to pay for surcharges for any or all special services in item A3 of Section 7, those special services shall be stopped without affecting other services. For example, if a Customer has an extra Refuse Container but is not paying the fee for the Container, the extra Container should not be Collected but all other Collection Services shall be provided.

A \$25.00 fee on returned checks (insufficient funds) may be charged to Customer.

Plain Language Table

Elapsed Time	Action
Before or on 1st day of the month	Bill sent to Customer
1 month	Bill due to CONTRACTOR
1.5 months	Reminder sent with warning of late fee
2 months	Unpaid bill delinquent, 10 percent late fee added
2.5 months	Reminder sent with warning of stop service, container removal, and interruption fee
3 months	Service stopped
3.5 months	Containers removed, \$25 interruption fee

The COUNTY may direct the CONTRACTOR to continue to provide Collection Services to delinquent Customers during health and safety emergencies (such as an earthquake, storm, or riot, pandemic or when Solid Waste is accumulating at Set-Out Sites for more than a week) as referenced in item B of Section 11.

SECTION 8 - WASTE CHARACTERIZATION STUDY

A. Participate with County Study

CONTRACTOR shall cooperate with Director in conducting Solid Waste characterization studies and waste stream audits. Cooperation includes all the following:

- Diverting Collection Vehicles from their regular route to alternate locations;
- Emptying all Solid Waste from Collection Vehicles; and
- Providing Collection, transportation, and Disposal of Solid Waste remaining after the study or audit.
- Providing copies of route maps

SECTION 9 - RECORDS

CONTRACTOR's obligations and COUNTY's rights in this Section survive the term.

A. Record Maintenance and Retention

1. All Records

CONTRACTOR shall prepare and maintain all Records in accordance with generally accepted accounting principles during the Term and for an additional period of not less than five years after the Expiration Date or any longer period required by Applicable Law.

a. *Legal Requirements*

CONTRACTOR shall maintain all records required under Applicable Law, including:

(1) records pertaining to Solid Waste Collection, and Disposal under County Code Section 20.72.160.

b. *Inter-jurisdictional Routes*

(1) *Acknowledgement*

CONTRACTOR acknowledges that if CONTRACTOR erroneously attributes Solid Waste that CONTRACTOR Collects in incorporated cities, other counties or Garbage Disposal Districts with Solid Waste that CONTRACTOR Collects in the unincorporated areas of the COUNTY under this CONTRACT, then the COUNTY may be subject to fines for failure to Divert Solid Waste from landfill Disposal as required under AB 939.

(2) *Obligation*

CONTRACTOR shall comply with 14 CCR 18808.7 and maintain records used to prepare Reports submitted to COUNTY, including jurisdiction of origin necessary to determine the weight of Solid Waste that CONTRACTOR Collects in the Service Area. CONTRACTOR shall document the method by which it allocates Solid Waste Collection route that includes a jurisdiction other than the COUNTY.

2. Disposal Records

CONTRACTOR acknowledges:

a. Claims

That COUNTY may need to respond to claims under CERCLA or similar Applicable Laws with respect to Disposal of Solid Waste.

b. Quantity

COUNTY's need to determine the quantity, location, and date of CONTRACTOR's Disposal of Solid Waste.

Therefore, CONTRACTOR shall establish and maintain a protocol for the retention and preservation of those Records, for a period of five years after the Expiration Date or any longer period required by Applicable Law, which protocol will document where CONTRACTOR Disposed of Solid Waste that it Collected (whether landfilled, incinerated, composted, or otherwise processed or marketed).

3. Notification

CONTRACTOR shall give Notice to Director at least 30 days before destroying Records of Disposal at any time after the retention period referred to in item A1 of Section 9.

B. County Custody

If Director has reason to believe that Records may be lost, discarded, or destroyed for any reason, Director may require that CONTRACTOR give COUNTY custody of any or all Records. Access to those Records will be granted to any Person duly authorized by CONTRACTOR. CONTRACTOR shall pay for storage cost.

C. Inspection and Review of Records

Upon five Service Days' notice by telephone or writing, or a lesser amount of time in the event of extraordinary circumstances, Director and/or its contractor may inspect, review (including using outside contractor), excerpt, transcribe, and copy all Records at CONTRACTOR's Office during CONTRACTOR Office Hours. CONTRACTOR may maintain Records outside of COUNTY (1) if it promptly provides copies thereof to Director at Director's offices, (2) if Director, in its sole discretion, agrees to travel outside COUNTY and CONTRACTOR pays COUNTY's Reimbursement Costs.

In addition to travel costs, COUNTY will bear the expense of the review and of obtaining a copy of Records; however, within 30 days of Director Notice, CONTRACTOR shall reimburse COUNTY for COUNTY's Reimbursement Cost of

the expenses for the review if the review reveals a discrepancy of the lesser of 3 percent or \$2,500 between:

- The amount contained in the Records (e.g., the amount of Solid Waste Collected or Diverted), and
- Any representation or Report that CONTRACTOR made to COUNTY; Franchise Fee or other money paid to COUNTY; County Service Fees paid by COUNTY, or information that CONTRACTOR submitted to Director.

Director may give Notice to CONTRACTOR identifying any discrepancy.

CONTRACTOR shall pay any discrepant shortfall in Franchise Fee or other payments due COUNTY, or excess of County Service Fees, upon Director demand, including fees and charges for the late payment of Franchise Fees. Failure to make those payments will constitute a CONTRACTOR Default in accordance with Part 3 of Exhibit 5. In lieu of payment, Director in its sole discretion may (1) deduct that shortfall from amounts that COUNTY owes CONTRACTOR under this CONTRACT, other contracts, or any other obligation, or (2) draw that shortfall from the performance bond, letter of credit, certificate of deposit, or other form of performance assurance provided by CONTRACTOR in accordance with Section 15.

COUNTY will pay any discrepant shortfall in County Service Fees due CONTRACTOR up to COUNTY's maximum obligation for County Service Fees appropriated by COUNTY for purpose of this CONTRACT.

D. Copies of Audits

If anyone, including Federal or State auditors and auditors or accountants employed by CONTRACTOR or others, conducts an audit of CONTRACTOR specifically regarding this CONTRACT, then within 30 days of the audit report, CONTRACTOR shall file a copy of the audit report with County's Auditor-Controller and notify Director of the filing, unless otherwise provided by Applicable Law. Subject to Applicable Law, COUNTY shall make a reasonable effort to maintain the confidentiality of such audit report(s).

E. Submission of Records

CONTRACTOR shall submit to Director, without charge to COUNTY or charge to Customers, any Records relating to Diversion requested by Director to assist COUNTY in meeting obligations imposed by Federal, State, and local laws. CONTRACTOR shall submit those Records by using the data management system forms used for submitting Reports or as requested by Director.

F. Public Record Request

1. Exclusive Property

The following become the exclusive property of COUNTY:

- Any Record or other document that CONTRACTOR gives Director, including about the procurement of this CONTRACT (such as proposals);
- Any Record or other document that Director obtains about Director's audit or inspection under this CONTRACT, including books and accounting records.

The above Records or other documents become a matter of public record and shall be regarded as public records, *except* if CONTRACTOR marks them as a "trade secret," "confidential," or "proprietary," they will be deemed excluded from disclosure under Government Code 6250 et seq. (Public Records Act). However, if a requestor seeking records marked "trade secret," "confidential," or "proprietary" does not agree that the records are exempt, then COUNTY will notify the CONTRACTOR that such records will be produced, unless the CONTRACTOR intercedes and files an injunction or other action to legally prevent disclosure.

CONTRACTOR agrees that COUNTY shall not in any way be liable or responsible for the disclosure of any such records including, with limitation, those so marked, if law requires disclosure, or by an order issued by a court of competent jurisdiction.

2. Defend, Indemnify and Hold COUNTY Harmless

CONTRACTOR shall defend, indemnify and hold harmless County from all costs and expenses, including reasonable attorney's fees, in connection with any requested action or liability arising under the Public Records Act, including request for any of the Records or other documents marked "trade secret," "confidential," or "proprietary." CONTRACTOR releases COUNTY from liability or responsibility for disclosing Records or other documents including those so marked, if Applicable Law require disclosure, including an order issued by a court of competent jurisdiction.

SECTION 10 - REPORTS

A. Types and Content

1. Quarterly Reports

The Director may request any Reports or data be reported prior to the Quarterly Reports submissions as referenced under subsection D of this Section.

Within 30 days after the end of each calendar quarter, or as determined by Director, CONTRACTOR shall submit the Quarterly Report for the preceding three (3) calendar months ending with that month to Director using the forms maintained on the data management system or provided by Director, which includes the following information:

a. Tonnage Report

CONTRACTOR shall report the total quantities in Tons of Materials Collected, Transferred, Processed, and Disposed by the CONTRACTOR. The report shall contain Tonnage data broken down by Container type Collected and must identify each Processing facility(ies) utilized for each Container type Collected.

b. Rejected Recyclables and Organic Waste

CONTRACTOR shall report the number of loads and Tons of Recyclables and Organic Waste rejected for Processing based on the Collection Container, together with the reason for rejection and facility at which the rejected materials were Disposed.

c. Educational Materials

CONTRACTOR shall report all educational materials distributed, and any events attended by CONTRACTOR to its Customers. Reports shall include dates when materials were distributed, along with the Service Area(s) it was distributed, location of events held, and which Customer type received the education material (i.e., Residential, Multifamily, Commercial, or all Customers).

d. Non-Collection Notices

CONTRACTOR shall report the total number of Non-Collection Notices issued, date/time of non-collection incidents, and the reasons for issuance including the list of Customers along with the Customer/Occupant information such as addresses, and service

levels. CONTRACTOR shall also provide dated photographic evidence of Non-Collection Notices issued and photographs of Customer non-collection incidents.

e. *Customer List*

CONTRACTOR shall report and provide a Customer list which includes all active and inactive accounts, account numbers, name associated with each account, Customer phone number, address and e-mail address, service site location address, level of service and material type Collected for each Container provided at each address, service day(s), additional services provided, indicate exemption or waiver type if applicable, and any other information associated with the Scope of Services as requested by Director.

Along with COUNTY's Customer list, the CONTRACTOR must provide their incorporated Customer list which should only include the Customer's service location addresses.

CONTRACTOR shall also indicate which Customers are not subscribed or adequately subscribed to Solid Waste Collection Services.

Additionally, CONTRACTOR shall report on Customers mentioned in subsection B of Section 1.

f. *Financial Report*

CONTRACTOR shall provide financial report(s) for all serviced Customers. Financial reports may also include a monthly billing and gross receipts report. The report(s) shall include and are not limited to, account number, account name, account address, service location/site address, invoice number, invoice date, billing amount/current charges in detail by billing description (i.e. 4YD FL Refuse, 3YD FL Recycle, late charge, etc.), payment received, payment date, payment type (i.e. check/cash/money order), account balance to date, and any other information as requested by Director.

g. *Customer Service Communications Log*

CONTRACTOR shall provide a copy of the customer service log which should include all service complaint activities and SB 1383 Regulatory Non-Compliance Complaints.

(1) *Service Complaints*

Logs shall include the Customer's information such as Occupant and/or Customer's phone number and/or e-mail

address, address, a summary of the type and number of complaints, missed pickups, and Non-Collection Notices and their resolution in a format acceptable by COUNTY.

(2) SB 1383 Regulatory Non-Compliance Complaints

CONTRACTOR shall report the number of complaints that were received and investigated, and if applicable, any educational materials issued to the Customer and resolution as referenced in item D1d of Section 6.

h. Containers Removed Upon Director Request

(1) Carts or Dumpsters Stored in Right-of-Way

CONTRACTOR shall report the number and addresses of Containers removed, fees charged, and Containers returned, per item C7d of Exhibit 3A1.

i. Contamination Monitoring

CONTRACTOR shall report the number of route reviews conducted for contamination monitoring and the number of times notices, violations, or targeted education materials were issued to Customers for Container Contaminants including the total number of Containers Disposed as Refuse due to the observation of Container Contaminants as described in item J1 of Exhibit 3A1.

j. Facility List

CONTRACTOR shall report and identify all Solid Waste Facilities used to Process all materials Collected. If utilizing a High Diversion Organic Waste Processing facility to Process Mixed Waste Collection, CONTRACTOR shall identify such facility and must include the Recycling and Disposal Reporting System (RDRS) identification number for the facility(s).

CONTRACTOR shall also report the facility tip fee and Diversion rates per Processed material group (e.g., Recyclables, Organic Waste, Food Waste and Mixed Waste).

k. Customer Waivers

CONTRACTOR shall maintain a record of waiver requests and COUNTY issued De Minimis and Physical Space waivers. CONTRACTOR records must reflect COUNTY Records and any changes to a Customer's eligibility shall be reported to the COUNTY immediately. CONTRACTOR shall also notify the COUNTY of

generators CONTRACTOR believes is eligible for a De Minimis and/or Physical Space waiver.

l. Site Visits

CONTRACTOR shall provide the Director a detailed summary Report of the site visits that were conducted and it shall include the following: No. of site visits performed during the quarter, the name and address of each Customer visited including the contact name and phone number, the date of each visit, any recommendations for service level changes, any outreach provided and summary of site visit and outcome.

m. Commercial Edible Food Generators

CONTRACTOR must report to COUNTY if they notice Edible Food in any Solid Waste Container and indicate the estimated percentage and/or pounds of Edible Food Disposed.

In addition, the Report shall include the Commercial Edible Food Generator's business name if applicable, the corresponding account holder name(s), account number, contact information, address, and photographic evidence of the Disposed Edible Food.

n. Bulky Item Collections

CONTRACTOR shall report all Customers that received Bulky Item Collection Services, number of pick-ups and number of items in each pick-up.

o. Contamination and Other Fees

CONTRACTOR shall provide to Director a list of Customers who were charged a contamination fee, Container violation fee or an extra pick-up fee as referenced In Exhibit 7, Attachment 7-2 (Extra Services Fees).

p. Collection Route Maps

CONTRACTOR shall e-mail changes in Collection route maps and schedule during the prior month.

q. Special Events Collection

CONTRACTOR must notify and report to COUNTY the Collection Services that CONTRACTOR provided at any special events located within the unincorporated communities of Los Angeles County.

The Report shall include the type of Collection Service provided (e.g., Refuse, Recycling and/or Organic Waste Collection) and service level, name and address of event, event coordinator contact information, and any other information associated with the event that may be requested by the Director.

Additionally, CONTRACTOR must notify COUNTY immediately if the special event includes any Edible Food activity.

2. Annual Report

On or before each February 28, CONTRACTOR shall submit the Annual Report to Director in a form satisfactory to Director, for the preceding Calendar Year, including the following information:

a. Solid Waste Diversion Program Implementation

A Report of CONTRACTOR's compliance with its Performance Obligations with respect to Solid Waste Diversion program implementation during the preceding Calendar Year. This Report includes, but is not limited to, CONTRACTOR explanation of their Solid Waste Diversion efforts.

b. Subcontractors

An updated list naming all Subcontractors, the amount of Goods or Services that each Subcontractor provides to CONTRACTOR, and a description of CONTRACTOR's relationships to each Subcontractor (including ownership interests) in accordance with Part 5K of Exhibit 5.

c. Collection Vehicle Compliance

Each Vehicle's compliance with any applicable local, state and federal regulations and requirements including South Coast Air Quality Management District Rule 1193, Clean On-Road Residential and Commercial Collection Vehicles, and Diesel Particulate Matter Control Measures (13 California Code of Regulations 202 et seq.).

d. Scavenging

A narrative description of efforts made to deter and prevent unauthorized removal or scavenging of Recyclables.

e. Vehicles

An inventory of Vehicles assigned to the Service Area and information on each Vehicle including its number, fuel type, year,

make, model, license plate number, VIN number, assigned route with start and finish points, days of service, type of material Collected, and number of accounts being serviced. CONTRACTOR shall update and submit immediately if any Vehicle, route or information has changed during the prior year.

f. Procurement of Recovered Organic Waste Products

(1) RNG Procurement

CONTRACTOR shall report the total amount of renewable natural gas (RNG) procured by CONTRACTOR for use in automated Collection Vehicles dedicated for CONTRACTOR's Service Area, pursuant to Section 3C, in diesel gallon equivalents (DGE). The CONTRACTOR shall include copies of any receipts, invoices, or other similar documentation evidencing procurement.

(2) Alternative Procurement Plan (If Applicable per item J4 of Exhibit 3A1)

CONTRACTOR shall include copies of any receipts, invoices, or other similar documentation evidencing procurement activities.

g. Processing Facility Reports

(1) Plastic or Compostable Bags

If CONTRACTOR Collects Organic Waste in plastic or Compostable bags, CONTRACTOR must provide a written representation and warranty from the Processing facility to the Director that the approved Organic Waste Processing Facility has and will continue to have the capabilities to Process and remove plastic or compostable bags when it recovers Source Separated Organic Waste.

(2) High Diversion Organic Processing Facility

CONTRACTOR shall provide copies of quarterly and annual average Mixed Waste Organic content recovery rates for each High Diversion Organic Waste Processing Facility used by CONTRACTOR to demonstrate that the facility(ies) meets or exceeds the Organic Waste content recovery requirements specified in 14 CCR Section 18984.3.

(3) Compostable Plastics

If CONTRACTOR accepts Compostable Plastics, CONTRACTOR must provide a Written notification to the Director that the approved Organic Waste Processing Facility(ies) has and will continue to have the capabilities to Process and recover the Compostable Plastics included with the Source Separated Organic Waste transported to the approved Organic Waste Processing Facility.

(4) Quarantined Organic Waste

CONTRACTOR shall provide a record of all compliance agreements for quarantined Organic Waste that are Disposed of, including the name of Generator, date issued, location of final disposition, and the amount of quarantined Organic Waste that was required to be Disposed at a Landfill.

(5) Temporary Equipment or Operations Failure

If CONTRACTOR is granted a Processing facility temporary equipment or operational failure waiver in accordance with item D5 of Exhibit 3A1, CONTRACTOR shall report the following documents and information:

- a. The number of days the Processing facility temporary equipment waiver or operation failure waiver was in effect;
- b. Copies of any notifications sent to the Director pursuant to item D5 of Exhibit 3A1, and copies of COUNTY notices to CONTRACTOR pursuant to item D5 of Exhibit 3A1;
- c. Documentation setting forth the date of issuance of the waiver, the timeframe for the waiver; and,
- d. A record of the Tons of Recyclables, Organic Waste, and Mixed Waste materials redirected to an alternative Solid Waste Facility or Disposed at an approved Solid Waste Disposal Facility as a result of the waiver, recorded by Collection Vehicle or transfer vehicle number/load, date, and weight.

3. Reports of Unauthorized Collectors

As described in item B10 of Section 1, if CONTRACTOR discovers that any Person is providing MSW Management Services in the Service Area who is

not authorized by Director or is in Violation of Applicable Law, then CONTRACTOR shall promptly e-mail Director with the following:

- The identity and address of the Person ("Violator"), if known;
- The facts and documentation supporting CONTRACTOR's report; and
- Any other information or documentation about the Violator and CONTRACTOR's report that Director may reasonably request.

COUNTY acknowledges that CONTRACTOR may seek legal or injunctive relief against the Violator in accordance with Applicable Law to cease providing those MSW Management Services. Notwithstanding the foregoing, COUNTY is not liable to CONTRACTOR, and CONTRACTOR hereby releases COUNTY from liability for any act of a Violator.

4. Legally Required Reports

CONTRACTOR shall file all Reports required under Law, including County Code Section 20.72.50 (Area, Services, Rates and Schedules).

5. Improper Solicitations

CONTRACTOR shall immediately report any attempt by a COUNTY officer or employee to solicit improper consideration (including in the form of cash; discounts; service; or the provision of travel, entertainment, or tangible gifts), to:

(1) COUNTY manager charged with the supervision of the employee;

or

(2) the COUNTY Fraud Hotline at (800) 554-6861 or www.fraud.lacounty.gov

B. Submission of Reports

CONTRACTOR shall submit Reports in a format compatible with COUNTY's computers and shall submit Reports using the following methods:

1. Quarterly Reports and Annual Report

Submitted via e-mail or other electronic form or printed copy, as determined by Director, in accordance with this Section and Section 12.

C. Reporting Adverse Information

CONTRACTOR shall provide Director copies of all Reports, pleadings, applications, notifications, and notices of violation, communications or other material directly relating to its Performance Obligations submitted by

CONTRACTOR to, or received by CONTRACTOR from Regulatory Agencies, including any of the following:

- The United States or California Environmental Protection Agency;
- CalRecycle;
- The Securities and Exchange Commission;
- Any other Regulatory Agency; and,
- Any Federal, State, or County court.

CONTRACTOR shall submit copies to Director simultaneously with CONTRACTOR's submission of those materials to those entities. At Director's request, CONTRACTOR shall promptly make available to Director any other correspondence between CONTRACTOR and those entities.

D. County's Right to Request Information

At Director's request, CONTRACTOR shall promptly provide to Director additional information reasonably and directly pertaining to this CONTRACT (including substantiation of information submitted in Reports).

E. Reports of Cybersecurity Breaches

CONTRACTOR must notify the Director immediately if CONTRACTOR's data security system encounters any cyber security breach.

SECTION 11 - SUBSTITUTE, EMERGENCY AND BACK-UP SERVICE

A. Director's Right to Provide Contract Services

1. Events

COUNTY may provide, or contract with a third party to provide, for the performance of, any or all Customers services in either of the following events, determined by Director in its sole discretion:

a. Unable for a Period of 48 Hours to Collect

- For 48 consecutive hours CONTRACTOR does not Collect and Dispose of any type of Solid Waste for any reason, including Uncontrollable Circumstances, or
- Director determines there is danger to public health, safety, or welfare.

b. COUNTY Suspends or Terminates CONTRACT

COUNTY suspends or terminates all or a portion of the CONTRACT.

COUNTY has no obligation to continue providing any or all Contract Services. It may stop providing them at any time, in its sole discretion. However, COUNTY may continue to provide those Contract Services until either of the following occurs:

- CONTRACTOR demonstrates to Director's satisfaction that CONTRACTOR is ready, willing, and able to resume providing timely and full Contract Services, or
- Director can make alternative arrangements for providing MSW Management Services comparable to Contract Services in scope and price. Alternative arrangements may include contracting with another, third-party service provider.

2. Notice

Director may give CONTRACTOR oral notice that Director is exercising its right to perform Collection Services, which notice is effective immediately, but must confirm oral notice with a Notice within 24 hours thereafter.

3. Stipulations

CONTRACTOR stipulates that COUNTY's exercise of rights under this Section does not constitute a taking of private property for which COUNTY must compensate CONTRACTOR, shall not create any liability on the part

of COUNTY to CONTRACTOR, and does not exempt CONTRACTOR from any Indemnities, which Parties acknowledge are intended to extend to circumstances arising under this Section. However, CONTRACTOR is not required to indemnify COUNTY against claims and damages arising from the negligence or misconduct of COUNTY officers and employees (other than employees of CONTRACTOR at the time COUNTY began performing Collection Services) and agents driving Vehicles. COUNTY shall indemnify CONTRACTOR, its Affiliates and its and their officers, directors, employees, and agents from and against damages, costs, or other expenses or losses they incur arising out of or relating to that negligence or misconduct.

4. Rental and Other Compensation

a. *Uncontrollable Circumstances*

If an event enumerated in items A1a or A1b in Section 11 is due to Uncontrollable Circumstances, then COUNTY shall pay CONTRACTOR the Direct Costs below.

(1) *Rental Fees*

Rental fees for the use of equipment equal to fair market value thereof as determined by an independent appraiser selected by the Parties.

(2) *Vehicles*

CONTRACTOR's Direct Costs of providing Vehicles with fuel, oil, and other maintenance.

(3) *Personnel*

CONTRACTOR's Direct Costs of making CONTRACTOR's personnel available to COUNTY, including Direct Costs of using CONTRACTOR's personnel to operate CONTRACTOR's equipment or vehicles.

The Parties shall select an appraiser as follows: within ten days after CONTRACTOR requests payment of rental fees in events described in item (1) of this subsection 4a, each Party will prepare a separate list of five Persons who do not work for either Party having experience in Solid Waste equipment appraisal, in numerical order with the first preference at the top, and exchange and compare lists. The Person ranking highest on the two lists by having the lowest total rank order position on the two lists is the appraiser. In case of a tie in scores, the Person having the smallest difference between the rankings of the two Parties is selected; a coin toss determines other ties. If no Person appears on both lists, this procedure is repeated.

If selection is not completed after the exchange of three lists or 60 days, whichever comes first, then each Party will select one Person having the qualifications and experience described above and those two Persons will together select an appraiser.

b. Other Than Uncontrollable Circumstances

If an event enumerated in items A1a or A1b in Section 11 is not due to Uncontrollable Circumstances, then COUNTY will not be obligated to pay the compensation and CONTRACTOR shall pay COUNTY's Reimbursement Costs within 10 days of COUNTY's submitting an invoice, therefore. If CONTRACTOR does not so timely pay, COUNTY may draw upon any performance bond, letter of credit, or other security provided under this CONTRACT.

B. Customer Services - Response to Emergencies

Depending on the extent and magnitude of an emergency, Customers may encounter issues with making payments and CONTRACTOR may be unable to fulfill all CONTRACT requirements. Upon declaration of a Federal, State or Local emergency, Director may implement the following policies with written Notice regarding Collection Services:

1. No Stop Service

CONTRACTOR shall not stop service to any account for delinquent payment during an emergency. Not applicable to debt prior to the emergency.

2. No Late Fees

CONTRACTOR shall not charge late fees on bills unpaid amount incurred during the emergency. Not applicable to debt prior to the emergency.

3. Extended Payment Option

CONTRACTOR shall allow Customers up to 12 months after an emergency to make monthly payments to debt incurred during the emergency. Not applicable to debt prior to the emergency.

4. Adjustment of Existing Services

COUNTY shall consider implementing changes such as:

- **Non-essential services suspend**
 - Cart exchanges if they are still usable
- **Bulky Item collection may be delayed up to 3 weeks** from call-in (not applicable to service areas where call-in is not required)

- **Collection hours are expanded to 6 am to 8 pm**
- **Time required to speaking to a live customer service representative** may be extended but Public Works must be notified if the average time exceeds 20 minutes.
- **Weekly collection modified**
 - Biweekly Organic Waste
 - Biweekly Recyclables (residents stockpile and compact their Containers to fit more)
 - Alternating weeks of Recyclables and Organic Waste
 - Comingled trash with Recyclables and/or Organic waste.

5. Adjustment of Franchise Fees

a. Debt Incurred During Emergency

12 months after an emergency, COUNTY will pay to the CONTRACTOR half the amount of any debt incurred as a result of Customers not paying their bills during an emergency. CONTRACTOR must submit documentation to the satisfaction of the Director demonstrating the amount of any such debt. Future Franchise Fees invoices will be adjusted by Director. For example, if the CONTRACTOR has \$100,000 of unpaid bills 12 months after an emergency, Director will reduce the Franchise Fee invoice by \$50,000. If CONTRACT will terminate prior to the 12 months, Director will consider an alternate timeline.

At any time after the Director has authorized the debt to be deducted from Franchise Fee and CONTRACTOR is able to recover additional payments from Customers, or former Customers, those recovered funds must be shared equally with COUNTY.

b. Franchise Fee Payment Extension

Director will consider adjusting Franchise Fees during an emergency, extending the deadline to pay an invoice.

C. Backup Service Plan

CONTRACTOR shall implement its Backup Service Plan within seven days of Director request if Customer's Solid Waste is not Collected at Customer's Set-Out Site, including uncontrollable circumstances. Examples of circumstances include CONTRACTOR's employees on strike or mudslides, wildfires, or earthquakes that cause blocked or damaged roads. In the event there is a protracted service disruption due to any cause, CONTRACTOR will institute proactive actions to sustain Solid Waste Collection Services. Since Customers are expecting services that CONTRACTOR is not providing, CONTRACTOR shall propose the appropriate services below for Director approval and must not charge Customer or COUNTY for providing these services, unless noted below.

1. Provide Conveniently Located Dumpsters or Roll-off Containers

CONTRACTOR will place 3 or 4-yard Dumpsters and/or Roll-off Containers throughout the community in key locations approved by Director.

2. Offer Self-hauling of Solid Waste to a Facility

CONTRACTOR will use Reasonable Business Efforts to make arrangements with the Solid Waste Disposal Facility normally used by CONTRACTOR for this Contract to allow each Occupant to direct haul and dispose of their Solid Waste, 6 days per week. The facility shall only charge the Customer for Disposal costs for quantities exceeding 100 pounds and there shall be no minimum quantities.

Additionally, if Director determines the distance to the CONTRACTOR's usual facility is too far from Occupants, CONTRACTOR will arrange for a local facility to allow each Occupant to drop-off the Solid Waste.

3. Inform Customers of Temporary Procedures

CONTRACTOR will use Reasonable Business Efforts to inform Customers and Occupants of the above service and Disposal options. CONTRACTOR will provide Customers and Occupants with information on where and how to dispose of the Occupant's Solid Waste by the following means:

- A recording on its customer service line.
- Arrange for the broadcast of COUNTY's 30-second Public Service Announcement video on local cable access channels with CONTRACTOR to customize it to the situation, such as having text appear on the screen announcing date, times, and addresses.
- Contact local print media and produce a press release.
- Contact Customers and Occupants via phone, e-mail, or text messages.

4. Credit Policy for Missed Contract Services

a. Missed Curbside Collection

Since Occupant is expecting a Collection Service not provided, CONTRACTOR shall automatically credit Customer for each missed Collection. For example, if a strike disrupts 2 weeks of the 13 Collections in a quarter, CONTRACTOR would credit Customer 2/13 of that quarter's fee toward the next quarter's fee.

b. Other Customer Services

When CONTRACTOR is unable to offer Collection Services other than curbside Collection, such as Bulky Item Collection, Community Meetings, or other required services, CONTRACTOR shall provide evidence of cost associated with those services and offer alternate services acceptable to Director.

5. Provide Replacement Drivers and Security

CONTRACTOR shall use Reasonable Business Efforts to require all properly trained and licensed employees to operate Collection Vehicles to maintain core Disposal and Diversion services. As described in the above paragraphs, CONTRACTOR shall be properly staffed to provide drop-off services for each Occupant. In addition to CONTRACTOR staff, CONTRACTOR shall use drivers or Vehicles from other operations and other waste haulers.

Finally, in cases of a strike, CONTRACTOR shall work closely with a private security firm to guarantee a safe and consistent operation.

6. Identify Customers Requiring Priority Service

CONTRACTOR shall contact the elderly and disabled Occupants and shall use Reasonable Business Efforts to Collect putrescible Solid Waste from their residence.

D. Use of Goods, Services and Property

1. Dumpsters and Cart Acquisition Contracts

CONTRACTOR acknowledges that COUNTY must have full use and possession of Dumpsters and Carts to secure its rights under this Contract, including both the following:

- Providing substitute service in accordance with its remedies under Part 3 of Exhibit 5 for Breach or default, and
- Purchasing Dumpsters and Carts upon termination of this Contract.

Therefore, if CONTRACTOR does not own Dumpsters and Carts outright without encumbrance, any Dumpster and Cart Acquisition Contract shall allow the Guarantor, COUNTY or COUNTY designee, to do all the following:

- Assume CONTRACTOR's obligations under the Dumpster and Cart Acquisition Contract,
- Take use and possession of the Dumpsters and Carts, and
- Obtain the benefits of any outstanding Cart warranties.

“Dumpsters and Cart Acquisition Contract” means an instrument establishing a security interest in the Dumpsters and Carts or that otherwise encumbers or limits CONTRACTOR's interest in Dumpsters and Carts, including any of the following:

- Lease or lease-purchase agreement,
- Installment sales or other financing contract, or
- Note or other loan documentation.

2. Inventory

CONTRACTOR shall store unused Dumpsters and Carts in a secure location. CONTRACTOR shall update its Dumpsters and Carts inventory at both following times:

- In each Monthly Report and Annual Report, and
- Within one week of COUNTY request

3. Insurance

If COUNTY or Customers have possession and use of Goods, Services and Property, CONTRACTOR shall execute whatever documentation its liability insurers require to ensure that COUNTY and Customers are protected and covered by CONTRACTOR's general and automobile policies, including requesting and executing endorsements to those policies. CONTRACTOR is not obligated to pay any additional cost of those endorsements unless COUNTY reimburses CONTRACTOR for those costs. COUNTY may pay for any endorsements, additional premiums or other costs. CONTRACTOR authorizes COUNTY to call and confer with CONTRACTOR's insurance broker to determine what, if any, documentation or actions are necessary to achieve protection satisfactory to COUNTY. Upon COUNTY REQUEST, CONTRACTOR shall direct its insurance broker to cooperate with COUNTY.

4. Vehicle Certification for FEMA

CONTRACTOR shall cooperate with COUNTY to certify all Vehicles to be used for emergency work. CONTRACTOR shall not use non-certified Vehicles unless approved by Director.

SECTION 12 - ENFORCEMENT OF CONTRACT

A. As Provided by Law

Either Party may avail itself of any remedy available under law.

B. COUNTY's Additional Remedies

Without limiting COUNTY's remedies otherwise available under this CONTRACT in law or equity, at its option, COUNTY may enforce a Breach in any or all the following ways:

- Execute alternative CONTRACTs for MSW Management Services in the event of CONTRACTOR Default
- Seek to obtain injunctive relief and/or damages
- Assess damages under item D of this Exhibit
- With respect to a CONTRACTOR Default under Part 3B3 of Exhibit 5 (Failure to Provide Insurance, Bonds), immediately withhold payments due CONTRACTOR
- Draw on Performance Assurance / Letter of Credit under Section 15

C. Injunctive Relief

CONTRACTOR acknowledges that COUNTY's remedy of damages for a Breach may be inadequate for reasons including the following:

- The urgency of timely, continuous, and high-quality Collection Services, including Collection, transportation, and/or transfer for Disposal of wastes which constitute a threat to public health;
- The long time and significant commitment of money and personnel and elected officials (both COUNTY staff and private consultants, including engineers, procurement counsel, citizens, public agency colleagues, and elected County officials) invested in this CONTRACT, including developing COUNTY's Option Analysis dated February 2001 and implementing its recommendations through numerous meetings of a Working Group comprised of Solid Waste industry representatives from small and large businesses, requesting and evaluating qualifications and proposals for this CONTRACT (including CONTRACTOR's), reviewing and commenting on documentation submitted by CONTRACTOR in conjunction with execution of this CONTRACT, and review of CONTRACTOR Documentation;
- The time and investment of personnel and elected officials described in the preceding paragraph to develop alternative Solid Waste services for the price provided under this CONTRACT, and to negotiate new contracts therefore; and

- COUNTY's reliance on CONTRACTOR's technical Solid Waste management expertise.

Consequently, COUNTY is entitled to all available equitable remedies, including injunctive relief.

D. Recovery of Damages

1. Compensatory

Subject to CONTRACTOR's opportunity to cure under Exhibit 5 Part 3, and mitigation of any damages by COUNTY, in the event that COUNTY seeks recovery of damages for a Breach, COUNTY may seek either compensatory damages or liquidated damages, as follows.

- Amounts equal to any Franchise Fees, liquidated damages, or other amounts that CONTRACTOR has previously paid to COUNTY but are subsequently recovered from COUNTY by a trustee in bankruptcy as preferential payments or otherwise;
- If COUNTY terminates this CONTRACT for a CONTRACTOR Default or in the event of Criminal Activity in accordance with Part 3D2c of Exhibit 5, costs incurred by COUNTY to provide or reprocur MSW Management Services in lieu of Collection Services;
- If COUNTY terminates this CONTRACT before expiration for a CONTRACTOR Default or in the event of Criminal Activity in accordance with Part 3D2c of Exhibit 5, costs of MSW Management Services provided or reprocured in lieu of Collection Services more than Customer Service Rates for the balance of the Term remaining if this CONTRACT had not been terminated; and
- In the event of CONTRACTOR Default under Part 3B3 of Exhibit 5 (Failure to Provide Insurance, Bond), in COUNTY's sole discretion, obtain damages resulting from that Default.

COUNTY may draw upon the performance bond, letter of credit, certificate of deposit, or other form of performance assurance provided by CONTRACTOR in accordance with Section 15 to pay compensatory damages.

For CONTRACTOR's misrepresentation regarding contingent fees in Attachment 5-8H, in addition to terminating this CONTRACT, COUNTY may recover from CONTRACTOR the full amount of the proscribed commission, percentage, brokerage, or contingent fee.

2. Liquidated Damages

COUNTY may seek liquidated damages listed in Attachment 12-D2.

The Parties have set these liquidated damages in recognition of the following circumstances existing at the time of the formation of this CONTRACT:

- a. COUNTY incurred considerable time and expense procuring this CONTRACT to secure an improved level of Collection quality and increased Customer and Occupant satisfaction. Therefore, consistent and reliable Collection Services are of the utmost importance to COUNTY and Customers and Occupants.
- b. COUNTY has considered and relied on CONTRACTOR's representations as to its quality-of-service commitment in entering into this CONTRACT, and CONTRACTOR'S Breach represents a loss of bargain to COUNTY. CONTRACTOR is experienced in providing services like those described in Collection Services.
- c. Quantified standards of performance are necessary and appropriate to ensure quality, consistent, and reliable Collection, and if CONTRACTOR fails to meet its Performance Obligations, COUNTY will suffer damages (including its Customers and Occupants' inconvenience; anxiety, frustration, potential political pressure, criticism, and complaint by Customers and Occupants; lost Supervisors and staff time; deprivation of the benefits of this CONTRACT and loss of bargain) in subjective ways and in varying degrees of intensity that are incapable of measurement in precise monetary terms, and that it is and will be impracticable and extremely difficult to ascertain and determine the value thereof. It would be difficult for COUNTY to prove its loss resulting from CONTRACTOR's Breaches and nonperformance or untimely, negligent, or inadequate performance of County Services.
- d. The CONTRACT contains a reasonable statement of Collection Services in order that the Parties will realize their expectations. COUNTY expects that CONTRACTOR shall perform Collection Services with due care in a workmanlike, competent, timely, and cost-efficient manner. CONTRACTOR expects to realize a profit by performing Collection Services in accordance with the terms and conditions of the CONTRACT for County Service Fees.
- e. In addition, in the event of Breach or CONTRACTOR Default, urgency of protecting public health and safety may necessitate that COUNTY enter into emergency or short-term arrangements for services without competitive procurement at prices substantially

greater than under this CONTRACT, and the monetary loss resulting there from is impossible to precisely quantify. Time is of the essence.

- f. The CONTRACTOR accepts COUNTY's assessment of liquidated damages for certain Breaches as part of the consideration CONTRACTOR offers to COUNTY for the award of this CONTRACT to CONTRACTOR.
- g. Lastly, termination of this CONTRACT for CONTRACTOR Default and other remedies provided in this CONTRACT are, at best, a means of future correction and not remedies that make COUNTY whole for past Breaches and CONTRACTOR Defaults.

Therefore, the Parties agree that the liquidated damages listed in Exhibit 12-D2 represent a reasonable estimate and fair approximation of the amount of damages COUNTY would incur as a consequence of CONTRACTOR's Breach corresponding to each item of specified liquidated damages, considering all the circumstances existing on the date of this CONTRACT, including the relationship of the sums to the range of harm to COUNTY that reasonably could be anticipated and anticipation that proof of actual damages would be costly or inconvenient.

In signing this CONTRACT, each Party specifically confirms the following:

- The accuracy of the statements made above, and
- The fact that each Party had many opportunities to consult with legal counsel and obtain an explanation of this liquidated damage provision at the time that this CONTRACT was made.

E. County's Reimbursement Costs

CONTRACTOR shall pay COUNTY promptly upon request, COUNTY's Reimbursement Costs of conducting a nonroutine investigation of any alleged Breach, when appropriate in judgment of Director. CONTRACTOR shall reimburse COUNTY for COUNTY's Reimbursement Costs incurred because of CONTRACTOR's Breach, including failure to maintain insurance.

F. Waiver

No waiver by COUNTY of any Breach of any provision of this CONTRACT constitutes a waiver of any other Breach of that provision. Failure of COUNTY to enforce at any time, or from time to time, any provision of this CONTRACT will not be construed as a waiver thereof. The rights and remedies set forth in this item F are exclusive and are in addition to any other rights and remedies provided by law or under this CONTRACT.

SECTION 13 - UNPERMITTED WASTE SCREENING AND REPORTING

A. Protocol

CONTRACTOR shall develop and implement the Unpermitted Waste Screening Protocol in compliance with Applicable Law and including the following provisions:

- Ongoing employee training in identification, safety and notification procedures, including leaving Non-Collection Notices, when safe;
- Means of driver inspection, such as visual inspection during tipping of Carts into Vehicles;
- Immediate driver response, such as load segregation;
- Driver notification, such as calling CONTRACTOR's dispatcher or field supervisor;
- Notification of appropriate local agency or department;
- Appropriate action, such as segregation and containerization for manifesting and transport for Disposal in accordance with Applicable Law or securing services of permitted handling and transport company;
- Compliance with Applicable Law, including regulations of the United States Department of Transportation (DOT) (Title 49 CFR) and of the United States Environmental Protection Agency (Title 40 CFR); and
- Labels on Containers, described in item D of this Section.

B. Prohibition on Collection

CONTRACTOR shall not Collect any Unpermitted Waste that it finds in Refuse, Recyclables, or Organic Waste unless it is licensed under Applicable Law. If CONTRACTOR finds Unpermitted Waste it shall notify all Persons as required by Applicable Law.

C. Notice to Director

If CONTRACTOR sees anything that it reasonably believes or suspects may be Unpermitted Waste on any public property in COUNTY, CONTRACTOR shall immediately notify Director and all Persons in compliance with Applicable Law. Public property includes storm drains, streets, and other public rights of way.

D. Labels

CONTRACTOR shall conspicuously label Containers with embossing or other secure means prohibiting Customers from discarding Unpermitted Waste. CONTRACTOR shall submit the label and text for Director approval prior to placing any purchase order for Containers. Item C3 of Exhibit 3A1 contains additional Container requirements.

SECTION 14 - EXECUTION OF CONTRACT**A. Execution in Counterparts**

This CONTRACT, including dated signatures on amended Exhibits and attachments to those Exhibits, may be signed by the parties hereto in any number of original separate counterparts, including both counterparts that are executed on paper and counterparts that are in the form of electronic signatures. Electronic signatures include facsimile or e-mail electronic signatures. Each executed counterpart shall be deemed an original. All counterparts, taken together, constitute the executed CONTRACT.

The parties hereby acknowledge and agree that electronic records and electronic signatures, as well as facsimile signatures, used in connection with the execution of this CONTRACT and electronic signatures, facsimile signatures or signatures transmitted by electronic mail in so-called pdf format shall be legal and binding and shall have the same full force and effect as if a paper original of this CONTRACT had been delivered had been signed using a handwritten signature. CONTRACTOR and COUNTY (i) agree that an electronic signature, whether digital or encrypted, of a party to this CONTRACT is intended to authenticate this writing and to have the same force and effect as a manual signature, (ii) intend to be bound by the signatures (whether original, faxed or electronic) on any document sent or delivered by facsimile or, electronic mail, or other electronic means, (iii) are aware that the other party will rely on such signatures, and (iv) hereby waive any defenses to the enforcement of the terms of this CONTRACT based on the foregoing forms of signature. If this CONTRACT has been executed by electronic signature, all parties executing this document are expressly consenting under the United States Federal Electronic Signatures in Global and National Commerce Act of 2000 ("E-SIGN") and California Uniform Electronic Transactions Act ("UETA")(Cal. Civ. Code § 1633.1, et seq.), that a signature by fax, e-mail or other electronic means shall constitute an Electronic Signature to an Electronic Record under both E-SIGN and UETA with respect to this specific transaction.

B. Authority to Execute

COUNTY warrants that the individual signing this CONTRACT has been duly authorized by COUNTY to sign this CONTRACT on behalf of COUNTY and has the full right, power, and authority to bind COUNTY to this CONTRACT. CONTRACTOR warrants that the individual signing this CONTRACT below has been duly authorized by CONTRACTOR to sign this CONTRACT on behalf of CONTRACTOR and has the full right, power, and authority to bind CONTRACTOR to this CONTRACT.

SECTION 15 - PERFORMANCE ASSURANCE

A. Performance Bonds, Other Security

CONTRACTOR shall secure and maintain throughout the Term and until CONTRACTOR has complied with all its obligations that survive the Expiration Date a faithful performance bond, approved by COUNTY. The performance bond must be in a form satisfactory to COUNTY or, at COUNTY's sole and absolute discretion, any alternative security acceptable to Director, including cash, certified check payable to COUNTY, certificate of deposit, or letter of credit (together, "**Performance Assurance**"), in the amount not less than \$50,000.

The Performance Assurance secures full and timely satisfaction of Performance Obligations for Collection Services.

CONTRACTOR shall provide a Performance Assurance in the amount listed in the table below for the period beginning on the Execution Date and ending on the last day of the first Contract Year.

Service Area	Amount of Performance Assurance
San Gabriel Valley East	\$50,000

Beginning on the first day of the next Contract Year, and in all subsequent Contract Years, that amount must be not less than the sum of:

- 15 percent of CONTRACTOR's Gross Receipts from Collection Services minus any Franchise Fees for the prior Contract Year;
- + 110 percent of any Franchise Fees paid by CONTRACTOR during the first six months of the prior Contract Year;
- + 110 percent of any liquidated damages assessed CONTRACTOR by COUNTY during the first six months of the prior Contract Year; and
- + Up to \$50,000, at the discretion of Director;
- = **SUM OF PERFORMANCE ASSURANCE (\$50,000 MINIMUM)**

A performance bond must be payable to COUNTY and executed by a corporate surety licensed to transact business (admitted) as a surety in the State of California. The corporate surety must have an A.M. Best Rating of not less than A:VII, unless otherwise approved by Director. The form of performance bond may not allow the bond surety to substitute another Person to perform Collection Services but must provide for payment of moneys to COUNTY to; (1) secure substitute Collection Services; (2) remedy damages incurred by COUNTY, including reasonable expenses, attorney's fees, and liquidated and compensatory damages; (3) ensure satisfaction of all Performance Obligations, including payment of Franchise Fees; and, (4) repay any money recovered from COUNTY in any bankruptcy or similar proceedings relating to CONTRACTOR. The

performance bond must be conditioned on faithful performance by CONTRACTOR of all the terms and conditions of this CONTRACT, including payment of Franchise Fees and any liquidated damages.

Each Performance Assurance must be renewed to provide for continuing liability in the above amount notwithstanding any payment or recovery thereon. At least 30 days prior to the Execution Date and 30 days prior to any renewal of the Performance Assurance, CONTRACTOR shall deliver the Performance Assurance to Director.

Director may verify the accuracy and authenticity of the Performance Assurance submitted.

B. Further Assurances

In addition to all other rights and remedies it may have, within five days of County request CONTRACTOR will provide reasonable assurances that it can timely and fully meet its obligations under this CONTRACT in any or all of in the following events:

1. Labor

CONTRACTOR is the subject of any labor unrest (including work stoppage or slowdown, sick-out, picketing and other concerted job actions).

2. Tipping Fees

CONTRACTOR does not pay an identified Solid Waste Facility for services.

3. Employee Wages

CONTRACTOR does not pay wages to its employees, provide workers' compensation insurance required by law, or pay employment-related taxes or fees.

4. County

CONTRACTOR does not pay COUNTY any amount that COUNTY has charged CONTRACTOR.

5. Meet Obligation

In the COUNTY's judgment, the occurrence of either of the following events jeopardizes CONTRACTOR's ability to timely and fully meet its obligations under this CONTRACT:

- CONTRACTOR does not regularly pay its bills when due, or
- The entering of any judgment against CONTRACTOR or any Guarantor with respect to Criminal Conduct by CONTRACTOR or Guarantor.

“Assurance of Performance” means any or all of the following actions, as COUNTY requests:

- Reduction or elimination of insurance deductibles or self-insured retention,
- Providing or increasing the size of a letter of credit, or
- Providing an additional performance bond, certificate of deposit or other instrument.

SECTION 16 - CONTRACT SERVICE AREA INFORMATION

CONTRACTOR is to use and follow the information below provided by Director.

A. Maps

1. **Map of Exclusive Commercial Franchise Service Areas**

B. Service Areas Data Information

1. **Exclusive Commercial Franchise Service Areas Data**

C. Outreach

1. **Public Education and Outreach Guidelines**

SECTION 17 - CONTRACTOR DOCUMENTATION

A. CONTRACTOR's Compliance with CONTRACTOR Documentation

CONTRACTOR shall provide Collection Services in compliance with the CONTRACTOR Documentation attached as Exhibit 17.

B. Changes in CONTRACTOR Documentation

1. Notice to Director

CONTRACTOR shall give Director prompt Notice of any changes in CONTRACTOR Documentation listed in item A of Exhibit 17 Contractor Documentation, after the Execution Date. CONTRACTOR shall follow Notice procedure in Part 9F of Exhibit 5. Director's receipt of those changes will be evidenced by the following acknowledgment, appended in substantially this form to the changed CONTRACTOR Documentation:

From: Director Designee
Sent: Tuesday, May 09, 2017 4:55 PM
To: waste hauler
Cc: Business Relations and Contracts Division
Subject: Service Area Name - Acknowledgement of Notice

Acknowledgment: CONTRACTOR has submitted the attached CONTRACTOR Documentation.

Director Designee
Senior Civil Engineer
Los Angeles County Public Works
Office: 626-458-3573

2. Director Approval

CONTRACTOR shall submit to Director for review and approval any changes in CONTRACTOR Documentation listed in item B of Exhibit 17 Contractor Documentation, after the Execution Date. CONTRACTOR shall follow Notice procedure in Part 5F of Exhibit 5. Director's approval will be evidenced by the following acknowledgment, appended in substantially the following form to the changed CONTRACTOR Documentation:

From: Director Designee
Sent: Tuesday, May 09, 2017 4:55 PM
To: waste hauler
Cc: Business Relations and Contracts Division
Subject: Service Area Name - Acknowledgement of Approval

Acknowledgment: I have reviewed and approved the attached CONTRACTOR Documentation

Director Designee
Senior Civil Engineer
Los Angeles County Public Works
Office: 626-458-3573

IN WITNESS WHEREOF, COUNTY has by order of its Board of Supervisors caused this CONTRACT to be signed by Director, and CONTRACTOR has caused this CONTRACT to be signed by its duly authorized officers, as of the date first written above.

COUNTY OF LOS ANGELES

By 
Director of Public Works

APPROVED AS TO FORM:

DAWYN R. HARRISON
Acting County Counsel

By 
Deputy

VALLEY VISTA SERVICES, INC.

By 
President

DAVID PEREZ
Type or Print Name

Secretary

DAVID PEREZ
Type or Print Name

ACKNOWLEDGMENT

A notary public or other officer completing this certificate verifies only the identity of the individual who signed the document to which this certificate is attached, and not the truthfulness, accuracy, or validity of that document.

State of California
County of LOS ANGELES)

On 9-19-2022 before me, Jesse Quintana - Notary Public
(insert name and title of the officer)

personally appeared David Perez
who proved to me on the basis of satisfactory evidence to be the person(s) whose name(s) is/are subscribed to the within instrument and acknowledged to me that he/she/they executed the same in his/her/their authorized capacity(ies), and that by his/her/their signature(s) on the instrument the person(s), or the entity upon behalf of which the person(s) acted, executed the instrument.

I certify under PENALTY OF PERJURY under the laws of the State of California that the foregoing paragraph is true and correct.

WITNESS my hand and official seal.

Signature *Jesse Quintana* (Seal)



EXHIBITS TABLE OF CONTENTS

EXHIBIT 3A1 – Collection Services 1

A. Scope of Collection Services 1

B. State of California Mandatory Commercial Recycling and Organic Waste Recycling 10

C. Containers 10

D. Solid Waste Transportation, Processing, Diversion, and Disposal 17

E. Diversion 21

F. Special Services 24

G. Method of Payment for Collection Services 30

H. Transition Roll-Out Plan 30

I. Public Education and Outreach 32

J. Additional Services 37

K. CONTRACTOR Commitments Made in Proposal 41

L. Difficult to Service Areas 41

EXHIBIT 5 – Additional Contract Obligations 42

PART 1 - GENERAL CONTRACT REQUIREMENTS 42

A. Employment Eligibility Verification 42

B. Security and Background Investigations 42

C. Consideration of Hiring COUNTY Employees 42

D. Conflict of Interest 42

E. Fair Labor Standards Act 43

F. Consideration of Hiring GAIN and GROW Participants 43

G. Record Retention and Inspection/Audit Settlement 44

H. Compliance with COUNTY's Jury Service Program 45

I. CONTRACTOR's Charitable Activities Compliance 46

J. Social Enterprise Preference Program 46

K. Local Small Business Enterprise Preference Program 47

L. Disabled Veteran Enterprise Preference Program 48

M. CONTRACTOR Responsibility and Debarment 49

N. Reporting Requirements for Improper Solicitations 51

O. COUNTY's Quality Assurance Plan 51

P. Local Small Business Enterprise Utilization 52

Q. Compliance with COUNTY's Zero Tolerance Human Trafficking 52

R. Method of Payment and Required Information 53

S. Compliance with Fair Chance Employment Practices 53

T. Compliance with the County Policy of Equity 53

U. Contractor Independence 54

V. Contractor Alert Reporting Database (CARD) 54

W. Federally Funded Work 54

PART 2 - INDEMNIFICATION AND INSURANCE 56

A. Indemnification and Release of COUNTY 56

B. Insurance 58

C. Compensation for COUNTY Costs 64

D. Alternative Risk Financing Programs 64

PART 3 - SUSPENSION; TERMINATION; DEBARMENT BREACHES AND DEFAULTS . 65

A. Notice of Breach; CONTRACTOR Cure Notice 65

B. Contractor Default. The following constitute Contractor Defaults..... 65

C. Notice of Contractor Default..... 68

D. Suspension or Termination of CONTRACT 68

E. CONTRACTOR Responsibility and Debarment 71

F. Termination For Breach Of Warranty To Maintain Compliance With County
Defaulted Property Tax Reduction Program 72

PART 4 - TRANSFER OF CONTRACT 73

A. COUNTY Consent 73

B. CONTRACTOR Demonstration 74

C. Payment of COUNTY's Transfer Costs..... 74

D. County's Reimbursement Costs of Enforcement 75

PART 5 - GENERAL PROVISIONS 76

A. Exercise of Options 76

B. Independent Status 76

C. Damage to Property and Personal Injury 76

D. Venue 76

E. Changes and Amendments 77

F. Notices 77

G. Authorized Representative of Director 78

H. Authority and Representations; COUNTY Disclaimer 78

I. Criminal Activity 79

J. Delay of Performance Obligations 80

K. Subcontractors 80

PART 6 - DEFINITIONS AND INTERPRETATION OF CONTRACT 81

A. Definitions 81

B. Interpretation and Construction..... 81

C. Integration 82

D. Governing Law 82

E. Severability 82

F. Interpretation..... 83

PART 7 - COMPLIANCE WITH LAWS AND REGULATIONS 84

A. Applicable Law..... 84

B. COUNTY Child Support Compliance Program 86

C. County Defaulted Property Tax Reduction Program 86

PART 8 - LABOR-RELATED PROVISIONS REQUIRED IN COUNTY CONTRACTS .. 87

A. Labor Code 87

B. Notices to Employees 87

C. Prohibition Against Use of Child Labor 88

D. Nondiscrimination 89

E. Safety..... 90

F. COUNTY Lobbyists..... 90

ATTACHMENT 5-8G – Authorized Representative of COUNTY’s Director 91

ATTACHMENT 5-8H – CONTRACTOR’s Representations and Warranties..... 92

A. Status..... 92

B. Statements and Information..... 92

C. No Conflicts 92

D. No Approvals Required..... 92

E. No Litigation 92

F. Due Diligence 93

G. Compliance with Applicable Law 93

H. Ability to Perform..... 93

I. Contingent Fees 93

J. Opportunity to Comment..... 93

K. Solid Waste Facilities..... 93

L. Contractor Documentation 94

M. Personnel..... 94

ATTACHMENT 5-9A - Definitions 95

EXHIBIT 7 – Rate Adjustments..... 115

A. Service Rates Schedule..... 115

B. Discontinued Indices..... 118

ATTACHMENT 7-1 – Rate Adjustment Example 119

A. Annual increase or decrease in CPI..... 119

ATTACHMENT 7-2- SERVICE RATES 120

A. Table 1- Commercial Rates 120

B. Table 2- Multifamily Rates 120

C. Table 3- Residential Rates..... 120

D. Table 4- Single Pass Collection 120

E. Table 5- Extra Services Fees to Customer 120

F. Table 6- Other Additional Services Rates 120

EXHIBIT 12-D2 – Liquidated Damages 121

EXHIBIT 16 – Contract Service Area Information 126

A. Maps 126

B. Service Areas Data Information 126

C. Outreach 126

EXHIBIT 17 – Contractor Documentation 136

A. Notice to Director Required 136

B. Director Approval Required 136

EXHIBIT 3A1 – Collection Services

A. Scope of Collection Services

The CONTRACTOR shall provide Collection Services to all Premises of County Commercial Franchise Customers in the Service Area(s), in accordance with Section 1 Grant of Rights and Privileges and per the Collection method indicated by the CONTRACTOR and approved by the Director.

CONTRACTOR must provide all Customers that are subject to this CONTRACT the Minimum Default Solid Waste Collection Service which includes an automatic subscription of Refuse, Recyclables, and Organic Waste Collection Services, unless the Director approves an alternate Collection method.

If the COUNTY issues waivers/exemptions to Customers as specified in Section 1B, (Exclusions from Service) in this CONTRACT, the CONTRACTOR will not be required to provide Collection Services for the excluded material type. CONTRACTOR shall assist COUNTY with Customer waiver/exemption requests as specified in Section J2.

CONTRACTOR must provide Collection Services to Premises of the following:

1. County Commercial Franchise Customers

a. *Commercial Businesses*

The CONTRACTOR shall provide such services to all Commercial Businesses regardless of whether the Customer utilizes Cart and/or Dumpsters for Collection. However, the Director in its sole discretion may allow the Authorized Residential Franchise Waste Hauler to service a Commercial Business Customer with all Carts if Director finds such service would be more efficient or cost-effective.

b. *Multifamily Premises (5 Units or More)*

CONTRACTOR shall provide such services to Multifamily Premises (5 Units or More) including mobile home parks that have Carts service per individual unit and no Dumpsters. The Authorized Residential Franchise Waste Hauler shall be the default service provider for Multifamily Premises (4 Units or Less).

c. *Multifamily Premises with Carts and Dumpsters Services*

The CONTRACTOR shall provide such services to Multifamily Premises Including a Homeowner's Association (HOA) that selects to utilize Carts for individual tenants and Dumpster Containers for common areas onsite.

d. Residential Premises with Dumpster Services

The CONTRACTOR shall provide such services to all Residential Premises who utilize Dumpster Collection Services for Refuse, Recyclables, and/or Organic Waste. This may include Residential Premises that have Manure-only Dumpster services. Additionally, Customers who are being serviced under the Residential Franchise contract (Single Family and Multifamily of 4 Units or Less) that have Carts for Collection Services but only utilize Dumpsters for Manure Collection only, can receive Manure Collection Services by either the Authorized Commercial Franchise Waste Hauler or the Authorized Residential Franchise Waste Hauler. This provision also applies to Residential Premises operating a business on the property.

2. Collection Methods

Collection methods must be in compliance with Article 3, Section 18984 of SB 1383 regulations. The Director at its sole discretion may require the CONTRACTOR to implement any Collection method as indicated in Forms PW-2 and PW-3 Schedule of Prices.

Upon Contract Execution of this Contract, CONTRACTOR shall provide the Two-Container (Black and Green Container) Collection method to its Customers as approved by the Director. Additionally, CONTRACTOR shall utilize the PW-3 Schedule of Prices for Two-Container (B) Trash mixed with Recyclables (Black Container) and shall utilize the PW-2 Schedule of Prices for Organic Waste (Green Container) rates.

Every Customer will be provided a black Container that will collect both Refuse and Recycling materials together and a green Container that will collect Organic Waste only. The minimum base rate for Refuse includes the equivalent of a 64-gallon cart of weekly Organic Waste Collection Service per Customer at no additional charge unless the Customer requires service beyond the minimum. Any additional Containers are available for an additional cost.

All Collection methods and Processing facilities must be approved by the COUNTY and shall meet requirements set forth under item D1, CONTRACTOR Solid Waste Designated Facility in this Exhibit.

3. Commercial, Multifamily, and Residential Collection Services

CONTRACTOR shall provide the Minimum Default Collection Service for the Collection of Solid Waste (Refuse, Recyclables, and Organic Waste) to all County Commercial Franchise Customers including to some applicable

Residential Customers that utilize Dumpster services for the Collection of Solid Waste.

The Service Rates Schedule in Attachment 7-2 of Exhibit 7 includes the uniform rates that shall be applied to all Customers in each CONTRACTOR designated Service Area.

The Minimum Default Collection Service includes a minimum base rate for the level of service for Refuse which is agreed upon by the Customer and CONTRACTOR and shall be charged accordingly to the rates set forth in the Service Rates Schedule in Attachment 7-2 of Exhibit 7. The Refuse rate will automatically include a 64-gallon Cart of weekly Organic Waste Collection and a 96-gallon Cart of weekly Recyclables Collection Service per Customer, both at no additional charge unless the Customer requires service beyond the minimum. Any additional Containers are available for an additional cost. Levels of service will vary per Customer.

For the Two-Container Collection method, CONTRACTOR must provide Customers the minimum base rate for the level of service for Refuse which is agreed upon by the Customer and CONTRACTOR and shall be charged accordingly to the rates set forth in the Service Rates Schedule in Attachment 7-2 of Exhibit 7. The minimum base rate for Refuse includes the equivalent of a 64-gallon Cart of weekly Organic Waste Collection Service per Customer at no additional charge unless the Customer requires service beyond the minimum. Any additional Containers are available for an additional cost. Levels of service will vary per Customer.

Additional Recycling and Organic Waste Containers

Upon Customer request, the CONTRACTOR shall provide additional Recyclables, and Organic Waste Containers at the rates listed in the Service Rates Schedule in Attachment 7-2 of Exhibit 7, provided that the additional Containers are being used by the Customer or Occupant for the purposes of setting out additional Recyclable and Organic Waste materials for regular weekly Collection Services. Additional Container rates for Organic Waste must be no greater than the Refuse rates and Recyclables rates must be no more than half of the Refuse rates as specified in the Service Rates Schedule.

The CONTRACTOR shall work with each Customer to provide the appropriate number and size of Containers for the appropriate service level and collection frequency to meet the Customer's service needs, including Container space constraints.

a. In-Home Food Waste Containers

CONTRACTOR is to provide an in-home Food Waste Container (i.e., kitchen pail) to each Occupant of a Residential Premises and Multifamily Premises. The in-home Food Waste Container should be attractive enough to place on a kitchen counter and small enough to place in a dishwasher. In-Home Food Waste Containers shall be approved by the Director. It is anticipated that Occupants would use the Container to regularly transfer Food Waste from their kitchen to the designated Collection Container (e.g., green and/or black container) and eliminate the need for a plastic bag. While the first Food Waste Container is to be provided at no additional charge, CONTRACTOR must allow the purchase of additional Containers for the fee indicated in Exhibit 7, Attachment 7-2, Extra Services Fees. CONTRACTOR may request approval from the Director to not provide in-home Food Waste Containers if selected Collection Method does not include Source Separating Organic Waste.

b. Use of Plastic Bags for Organic Waste

CONTRACTOR shall allow Customers and Occupants to place Organic Waste in clear plastic bags and place the bagged Organic Waste in the designated Collection Container, in accordance with Sections 18984.1 and 18984.2 of SB 1383 regulations. CONTRACTOR must comply with reporting requirements set forth in Section 10 Reports.

4. Collection Schedule Requirements

CONTRACTOR shall Collect Solid Waste (Refuse, Recyclables, and Organic Waste) in the Service Area from Containers, and Bulky Items, as provided in this Exhibit.

a. Days Authorized to Collect

Residential Collection is only permitted Monday through Friday, except following a Holiday. Commercial Collection is only permitted Monday through Saturday, except following a Holiday.

b. Collection Hours

CONTRACTOR shall Collect only between the hours of 7 a.m. and 7 p.m., except for Collection from Commercial Customers and Occupants in accordance with County Code, including Section 12.08.520 Refuse Collection Vehicles.

If it becomes evident that CONTRACTOR may not be able to complete its scheduled work within the required hours, CONTRACTOR shall immediately notify Director and receive

approval to Collect outside of regular hours. Director may request a proposal for measures to be taken to maintain the scheduled service without delay or interruption.

CONTRACTOR shall not Collect in School Zones within 30 minutes of the school's starting time and ending times, or at any time that children are present.

CONTRACTOR shall use Reasonable Business Efforts to adjust the early morning start point of Collection routes to address and minimize Occupant complaints.

c. *Collection Frequency*

CONTRACTOR shall Collect all Solid Waste on the scheduled Collection Day(s), at least once per week from Customers. The frequency of Collection may be reduced at the discretion of Director, but it shall be implemented only if it is permitted by Applicable Laws. For example, the Collection frequency of Refuse may be reduced if Food Waste is not allowed in the Refuse Container or Recyclables Containers Collection frequency may be reduced to every other week.

Customers may increase the frequency of their Collection for an additional charge as indicated in the Service Rates Schedule in Attachment 7-2 of Exhibit 7.

d. *Collection Schedule*

CONTRACTOR shall follow the approved Collection schedule for the Service Area on the Service Days as indicated on the Collection schedule in Contractor Documentation in Exhibit 17 (Collection Schedule), or other schedule approved by Director if it significantly improves efficiencies.

For Customers that are impacted by street sweeping schedules, any proposed changes in the Collection schedule shall have the Service Day be one to two Service Days before streets are swept as provided in Director's schedule for street sweeping in the Service Area (If applicable). Director may amend this Collection schedule at any time, and CONTRACTOR shall use Reasonable Business Efforts to implement this amendment. CONTRACTOR shall prepare a Notice notifying the affected Customers and Occupants of the change and send such Notice to these Customers and Occupants upon receiving approval from Director.

e. Missed Collections

If Director, a Customer, or an Occupant notifies CONTRACTOR that CONTRACTOR has not Collected an Occupant's Solid Waste and not met its Performance Obligation, CONTRACTOR shall Collect at no additional charge:

- No later than 7 p.m. on the day of service, if it receives the complaint by 12 p.m.; or
- On the next Service Day, if the complaint is received after 12 p.m. on the day of service.

If CONTRACTOR believes such missed collection notifications were made in error, the CONTRACTOR can submit to the Director for approval, proof that Collection Services were provided to the Customer by submitting supporting documentation (such as GPS records, photographic evidence, etc.). In such case, the Director will review and make the final determination.

f. Holidays

CONTRACTOR shall observe the following Holidays:

- New Year's Day
- Memorial Day
- Independence Day
- Labor Day
- Thanksgiving Day
- Christmas Day

Collection shall be delayed one day for the Holiday and the remainder of the Holiday week. CONTRACTOR may Collect on Saturday of the same week for Residential Customers and Occupants and on Sunday for Commercial Customers and Occupants.

5. Non-Collection

For Collection instances described below, including when Containers are determined to contain Unpermitted Waste, contaminated Recyclables, or contaminated Organic Waste, or are overloaded (i.e., overfilled, overweight)

to the extent that the Container cannot be safely lifted, where Container contents will not empty after tipping, and/or are blocked or inaccessible, the CONTRACTOR shall follow the Container Non-Collection Procedure set forth below. All reasons for not performing Collection Services shall be documented or shall be treated as a missed Collection and will be subject to the associated Liquidated Damages in Exhibit 12-D2.

a. Container Non-Collection Events

(1) Unpermitted Waste

CONTRACTOR observes the presence of Unpermitted Waste within the Containers or within the vicinity of the Set-Out Site other than any Unpermitted Waste that CONTRACTOR Collects such as Bulky Items.

(2) Unsafe Condition

CONTRACTOR observes an unsafe condition at the Set-Out Site.

(3) Solid Waste Not Placed in Container

Solid Waste not placed in a Container. Bulky Items do not need to be placed in a Container, bag, or bundle.

(4) Not at Set-Out Site

A Container or a Bulky Item that is not placed at the Set-Out Site.

(5) Exceed Weight Limitations

A Container that exceeds any weight limitations as described in Exhibit 16 item D, Customer Terms and Conditions.

(6) Inaccessible Premises

The Premises are not accessible to Vehicles.

(7) Contamination

CONTRACTOR must follow provisions indicated in the Contamination Noticing Section in item J1 of Exhibit 3A1.

(8) Delinquent Payment

The Customer has not timely paid CONTRACTOR's invoice for Collection Services in accordance with item B7 of Section 7. One week prior to removing a Container for nonpayment of Customer Service Rates, CONTRACTOR shall also leave a notice for Occupants on a Container and call, e-mail or text Customer stating the deadline for payment.

The COUNTY may request the CONTRACTOR to continue to provide Collection Services to delinquent Customers during health and safety emergencies as determined by the COUNTY (such as an earthquake, storm, riot, pandemic or when Solid Waste is accumulating at Set-Out Sites for more than a week).

(9) Unscheduled Pickup

Unscheduled Bulky Items, textiles, wood/lumber and E-waste Collection that requires advanced scheduling for Collection as indicated in item F subsection 1c, 1d & 3a of this Exhibit. CONTRACTOR shall call, e-mail, or text Occupant by next Service Day to:

- Notify of the non-collection,
- Educate and explain why waste was not Collected, and
- Schedule the Collection.

(10) Overflowing Containers

CONTRACTOR determines that a Container is repeatedly filled beyond capacity and consistently overflowing.

b. Non-Collection Notice Procedure

(1) Non-Collection Notice

If CONTRACTOR does not Collect the Occupant's Solid Waste, the CONTRACTOR shall leave a written Non-Collection Notice when leaving the uncollected Solid Waste. The CONTRACTOR shall leave the written notice securely attached to Occupant's Container or Bulky Items unless it is unsafe to do so. CONTRACTOR shall also provide photographic evidence to the COUNTY demonstrating that the CONTRACTOR provided the written Non-Collection Notice to the Customer. CONTRACTOR will use the form of Non-Collection Notice

approved by the COUNTY included in CONTRACTOR Documentation in Exhibit 17.

At a minimum, Non-Collection Notices shall provide the following information:

- The CONTRACTOR's reason for not providing Collection Service.
- Information that will allow the Customer to correct the problem.
- CONTRACTOR's telephone number for any further questions.

CONTRACTOR shall report all non-collections in Quarterly Reports submitted to the COUNTY as specified in Section 10 Reports.

(2) Communication with the Customer

Whenever Solid Waste at the Premises of a Customer is not Collected, CONTRACTOR shall contact the Customer on the scheduled Collection day or within (24) hours of the scheduled Service day by telephone, e-mail, text message, or other verbal or electronic message to explain why their Solid Waste was not Collected.

(3) CONTRACTOR Return for Collection

Once the Customer corrects the non-collection event, and contacts the CONTRACTOR to collect their Solid Waste, CONTRACTOR shall collect Containers and/or Bulky Items within one (1) Service Day of Customer's request if the request is made at least two (2) Service Days prior to the regularly scheduled Collection Day.

Allowed only once per Calendar year, Customers that rectify the incident of the non-collection event will be granted a "one-time" no charge for the extra Collection service event ("extra pick-up"). This does not apply for unscheduled pickups as set forth in subsection a9 of this Section. Unscheduled Bulky Items, textiles, wood/lumber and E-waste shall be Collected the following week regardless if Customer or Occupant responds to the Non-Collection Notice as indicated in item F subsection 1c of this Exhibit. If the Customer repeats the offense more than once per Calendar year, Contractor may charge for the extra Collection service event ("extra pick-up"), at the applicable

approved rates set forth in Attachment 7-2 of Exhibit 7, Extra Service Fees.

If the Customer does not respond to the Non-Collection Notice or rectify the incident prior to their next scheduled Collection day, the CONTRACTOR shall Collect their Solid Waste if feasible and may charge the Customer a Container violation fee, at the applicable approved rates set forth in Attachment 7-2 of Exhibit 7, Extra Services Fees. CONTRACTOR must notify the COUNTY and receive final approval before charging the Customer any extra pick-up or Container violation fees on their next invoice.

B. State of California Mandatory Commercial Recycling and Organic Waste Recycling

The CONTRACTOR shall use all Reasonable Business Efforts to assist the COUNTY to comply with all laws, including but not limited to, regulations and permit conditions, that pertain to the services provided in accordance with this CONTRACT.

At the COUNTY's request and in the format requested, the CONTRACTOR shall be responsible for providing all required information and documentation to support that all Applicable Laws within this CONTRACT are being addressed. Failure to provide this documentation as requested will be subject to the reporting requirement performance standards listed in Exhibit 12-D2.

C. Containers

1. Container Colors

All Containers for the Collection of Solid Waste (Refuse, Recycling, and Organic Waste) shall be differentiated by color and shall be consistent throughout the Service Area and shall comply with CalRecycle requirements under SB 1383. Manure Collection Containers may be provided in any color, provided that it does not conflict with SB 1383 Container color requirements and is uniform throughout the CONTRACTOR'S Service Area. All Collection Container colors shall be approved by the Director prior to usage. Pictures of Container colors shall be provided to the Director upon request.

CONTRACTOR may also comply with this Section by providing a Container or Containers to its Customers that are split or divided into segregated sections, instead of an entire Container, as long as the lids of the separate

sections of a split Container comply with the Container color requirements and material limitations specified in Section 18984 of SB 1383.

Notwithstanding this subsection, the CONTRACTOR is not required to replace functional Containers, including Containers purchased prior to January 1, 2022 (or date specified in 14 CCR Section 18984.7, whichever date is later), that do not meet the following color requirements prior to the end of the useful life of those Containers or prior to January 1, 2036, whichever comes first. (Timeframe specified per 14 CCR Section 18984.7.)

Prior to ordering Containers for use under this CONTRACT, CONTRACTOR must receive approval from Director to ensure the proposed Container specifications and labels comply with Applicable Law(s) including SB 1383 regulations.

2. Split Containers

Lid and body colors of Split Carts and Split Dumpsters shall be approved by the Director at least thirty (30) days before CONTRACTOR's procurement of such Containers and shall conform with requirements of 14 CCR Section 18984.

3. Container Signage and Labeling Requirements

Carts, Dumpsters, Roll-Off Boxes, and other Containers provided by the CONTRACTOR to Customers shall be clearly identified with the different types of Solid Waste such as Refuse, Recyclables, Organic Waste, or Manure Containers, as applicable. All Containers shall display the CONTRACTOR's name (in letters not less than three (3) inches high) on the exterior of the Container to be visible when the Container is placed for use, local telephone number, website and some identifying inventory or serial number. CONTRACTOR shall place a label on Containers or provide Containers with imprinted text or graphic images, or both, on all Containers or on the lids of all Containers provided to Customers. The CONTRACTOR's labels or imprinted text and/or graphics on each Container must be clearly displayed and shall include legible text and/or graphics clear enough to read at all times, it must also indicate the primary materials accepted and the primary materials that are Container Contaminants in that Container, as required by 14 CCR Section 18984.8.

Container labels or imprinted text and/or graphics on each Container shall display the CONTRACTOR's name, local telephone number, website and some identifying inventory or serial number on the Container.

Additionally, Containers that are placed or designed to be placed on a roadway or the curb of a roadway pending Collection shall be marked with reflectors. If Containers are purchased from previous waste hauler, a

reflective sticker with the new logo may be placed over the old logo but stickers must be replaced if they fade or fall off. If CONTRACTOR is reusing their own Containers, there must be a reflective sticker or paint somewhere on the Container.

All Container labels and signage are subject to Director approval, which shall not be unreasonably withheld.

4. Container Cleanings

Customers are entitled to a free Container cleaning or Container change-out in each twelve (12) month period per Container upon request. Any cleaning requests beyond the required one (1) cleaning per year will be an additional fee as prescribed in Attachment 7-2 of Exhibit 7, Extra Services Fees. Any disputes concerning the CONTRACTOR's obligation for cleaning Containers shall be resolved by the COUNTY. The COUNTY's decision on the issue shall be final.

5. Graffiti Removal

The CONTRACTOR is responsible for removing graffiti from their Containers. CONTRACTOR shall remove any graffiti reported within seven (7) calendar days upon request of Director or upon hauler identification. Failure to maintain CONTRACTOR-owned Containers in accordance with the Performance Standards shall be subject to the associated Liquidated Damages listed in Exhibit 12-D2.

6. Container Placement

CONTRACTOR shall arrange for the location of a Set-Out Site directly with Customer or Occupant. If no arrangement is made, then the default location is the curb of the street for the address of the Customer or Occupant or in the alley behind the Customer or Occupant's property.

CONTRACTOR shall return empty Containers upright and to their Set-Out Sites. CONTRACTOR shall not impede pedestrian or vehicular traffic. The Set-Out Site should be located at the curb or as otherwise provided in County Code Section 20.72.177. CONTRACTOR shall not leave Containers after being serviced in the public right of way.

7. Delivery, Removal, and Exchanges

Within seven calendar days after receiving a Customers or Occupant's request for commencement or changes in Collection of Solid Waste, CONTRACTOR shall deliver Container of the Customer or Occupant's

requested capacity or replace existing Container with substitute Containers of the Customer or Occupant's requested capacity. CONTRACTOR shall not charge a fee according to the following:

a. Starting or Stopping Service

CONTRACTOR shall not charge for delivery or removal of Containers upon starting or terminating service.

b. One Annual Exchange of Containers

CONTRACTOR shall exchange one or more Containers for one or more Containers of a different size if requested by Customer or Occupant once each Calendar Year at no extra charge.

c. Multiple Exchanges of Container(s)

If a Customer asks CONTRACTOR to exchange Container(s) more than once each Calendar Year as described in item b above, CONTRACTOR may charge Customer the amount provided in Attachment 7-2, Extra Service Fees of Exhibit 7.

CONTRACTOR shall inform Customer of the fee prior to the exchange and give Customer the option of waiting for the exchange until the next Calendar Year to avoid the charge unless waiting will have a significant impact on their Recycling or Organic Waste Diversion.

d. Removal of Carts or Dumpsters Stored in the Public Right-of-Way

The storage of Solid Waste is not allowed within the public right-of-way. Containers left out after Collection may be an eyesore for the community, a threat to public health, and a nuisance to traffic.

(1) Third-Party Containers

At the request of Director, for Containers not owned by CONTRACTOR, CONTRACTOR shall, at no charge to COUNTY or Customer:

- Remove any container, including Carts, Dumpsters and roll-off bins that COUNTY deems abandoned, within two Service Days of request.
- Arrange for the Disposal or Diversion of Solid Waste within the container.

- Reuse, Recycle, or resell container.
- Notify Director to confirm removal.

(2) CONTRACTOR's Containers

At the request of Director, for Containers owned by CONTRACTOR, CONTRACTOR shall, at no charge to COUNTY:

Warn

- Tag Containers with a warning Notice that Solid Waste may not be stored in the right-of-way and the further leaving out of the Containers may result in their removal and a fee to return them.

Remove Container (only upon further direction from Director)

- Provide dated photographs of Containers and make available to Customer and Director, upon request.
- Remove any Cart or Dumpster from the Right-of-Way, within two Service Days.
- On the same day as removal, contact Occupant and Customer by telephone and by text or e-mail to notify them of the removal, the reason for it, and how to have it returned.
- Charge Customer the surcharge, as provided in Attachment 7-2, Extra Services Fees of Exhibit 7. Note that this surcharge may be increased by 25 percent for each additional occurrence within the past, rolling 12 months. For example, if the first time the fee was \$20, one month later it would be \$25, three months after that would be \$31.25, but 14 months later it would be back to \$20 (or whatever the current Basic Service Rate is with applicable rate adjustments).
- Charge an additional surcharge, as provided in Attachment 7-2, Extra Services Fees of Exhibit 7, if the Set-Out Site contains Solid Waste that CONTRACTOR places inside Containers upon their return.

Return

- Return Container(s) to Occupant within two service days of Customer's willingness to pay the return fee, such as having it added to the next monthly bill.

Notify Director

- Notify Director of the status of removals, payment of surcharges, and the return of Containers.

8. Repair and Replacement

a. Identification/Reporting

CONTRACTOR shall repair or replace damaged Containers that it observes are damaged when providing service and upon request from Director, Customer, or Occupant.

b. Fee

CONTRACTOR will repair or replace Containers without cost, except in the circumstances below. CONTRACTOR may charge the Customer for the actual cost of repair or replacement of Containers when:

- A Container is missing but Customers or Occupants do not report the theft of the Container to the police.
- The Container is damaged due to Occupant negligence such as disposing of hot ashes inside the Container or over-filling the Container so that lifting it damages the Collection Vehicle. Director's determination of Occupant negligence is final.

c. Repair or Replacement

CONTRACTOR shall repair or replace damaged Containers within two Service Days after CONTRACTOR observes the damaged Container or when requested by Director, Customer or Occupant. "Damage" includes missing or inoperable lids.

9. Inventory

CONTRACTOR shall maintain an adequate inventory of Containers and lids of each type and capacity to provide Customers and Occupants replacements within two Service Days of request. When determining adequacy, CONTRACTOR shall consider the nature of Set-Out Sites. For example, Carts and/or Dumpsters placed on unlevel Set-Out Sites, such as in mountainous areas without curb and gutter, may be damaged more frequently than those placed in level Set-Out Sites. Therefore, CONTRACTOR must maintain a larger inventory of Carts and Dumpsters for those areas.

CONTRACTOR shall notify Director if inventory is inadequate, including an explanation of why inventory dropped below the two-Service Day standard as mentioned in subsection 8c of this Section. For example, CONTRACTOR might submit its timely order for Containers but receive them later than manufacturer originally represented due to manufacturer's backlog or other delay.

10. Container and/or Cart Lids Purchase Option

Upon expiration of this Collection CONTRACT, COUNTY may purchase some or all entire Containers' bodies with lids, or only Cart lids, or both, at a price equal to the then book value of amortized on a straight-line basis over ten years beginning on the Execution Date. COUNTY's option includes both Containers and Cart lids then used by Customers and any in storage or in inventory as indicated in subsection 9. CONTRACTOR shall transfer or assign to COUNTY all rights necessary to give COUNTY ownership, possession and use of Containers and lids COUNTY is purchasing, including under any Containers and lid acquisition agreement, installment sale agreement, or lease.

11. Manure Service

CONTRACTOR shall offer Manure Collection Services to Customers and shall bill the Customer as provided in the Attachment 7-2, Extra Services Fees of Exhibit 7.

12. Bear Resistant Containers

Upon Customer request, CONTRACTOR shall offer bear-resistant Carts and Dumpsters. CONTRACTOR may charge for this additional service as listed in Attachment 7-2, Extra Services Fees of Exhibit 7.

13. Green Waste Containers

Upon Customer request, CONTRACTOR shall offer Green Waste only Carts and Dumpsters. CONTRACTOR may charge for this additional service as listed in Attachment 7-2, Extra Services Fees of Exhibit 7.

If a Customer has landscaping service, separate Green Waste only Collection Container, or generates no Green Waste then such Green Waste material does not have to be included in the Organic Waste Container.

14. Alternative Container Sizes

If a Customer or Occupant requests alternate Container sizes, CONTRACTOR shall provide the type of Containers described in

Contractor Documentation in Exhibit 17. For the purposes of this CONTRACT, Carts with a capacity between 95 and 100 gallons are equivalent to 0.5 cubic yards. CONTRACTOR shall provide the number of alternative Containers having the same aggregate capacity as CONTRACTOR would have provided to that Occupant. For example:

- Three 32-gallon Carts instead of one 96-gallon Cart.
- One 64-gallon Cart and one 32-gallon Cart instead of one 96-gallon Cart.

D. Solid Waste Transportation, Processing, Diversion, and Disposal

1. CONTRACTOR-Designated Solid Waste Facilities

CONTRACTOR shall transport Solid Waste only to the Solid Waste Facility or Facilities that CONTRACTOR has designated in Contractor Documentation in Exhibit 17, for Processing, Diversion, or Disposal or those facilities as directed by Director in subsection 6 below.

The CONTRACTOR shall select Solid Waste Facilities solely in its discretion, including transfer stations and material recovery facilities, composting and Disposal facilities. CONTRACTOR shall notify COUNTY of the Solid Waste Facilities that CONTRACTOR chooses for each respective type of Solid Waste (Refuse, Recyclables, Organic Waste, Manure, Bulky Items, and E-waste). For Construction and Demolition Debris, CONTRACTOR shall only utilize facilities approved by the COUNTY for Processing Construction and Demolition (C&D) Debris. All facilities utilized by the CONTRACTOR must be approved by the COUNTY as designated in Contractor Documentation in Exhibit 17. Additionally, CONTRACTOR shall allow the County at its own expense to conduct a third-party verification for Recyclables Recovery Rate of Solid Waste Facilities and materials recovery facilities utilized. The County will provide the CONTRACTOR a one week notice with scheduling options for CONTRACTOR to select for what is best for their operation. COUNTY may utilize CalRecycle's facility diversion audits if available in efforts to meet this requirement.

CONTRACTOR may designate a Solid Waste Facility or Facilities that utilizes Conversion Technology or provides feedstock to Conversion Technology facilities. Prior to any change in designated facilities, CONTRACTOR must provide Notification to Director for approval of change. Failure to receive approval from Director will result in rate adjustments being calculated based on the less expensive of the existing and previous facility. Director will review information such as fees, distance, Recycling rates, ability to Recycle Solid Waste.

If CONTRACTOR requests to take Solid Waste to a facility that charges more, Director may approve such requests without authorizing the CONTRACTOR to pass the increased cost to the Customer. At the Director's discretion, some or all the increased costs may be passed to the Customer under special circumstances such as changing Organic Waste Diversion from a cheaper but poorly managed composting facility to a highly efficient and closer anaerobic digestion facility that is more expensive.

2. Backup Disposal Facility

a. *COUNTY Direction*

If the Disposal facility is not accepting permitted waste, upon COUNTY approval CONTRACTOR will transport permitted waste to a backup Disposal facility identified by the COUNTY.

b. *Transport Fee*

The COUNTY will pay the CONTRACTOR the following transport fee for transporting permitted waste from the transfer station to the backup disposal facility for longer haul or CONTRACTOR shall decrease rates for shorter haul as described below:

(1) *Transport Fee Schedule lists both of the following amounts:*

- (a) Price for transporting one ton of waste for one mile (“\$X.XX / ton-mile”) as listed in Exhibit 7, Attachment 7-2, Schedule of Prices, and
- (b) The number of round-trip miles from the transport station to the Disposal facility (“# primary Disposal facility-miles”).

The number of miles is calculated on the shortest route on which CONTRACTOR can transport waste, for example, roads that support the weight of the loaded waste transport trucks.

- (c) **Longer Haul.** If the backup Disposal Facility is farther from the transfer station than is the primary Disposal facility, then the transport service fee will be increased as follows to reflect the additional transport miles:

\$X.XX [INSERT FROM PROPOSAL] transported tons
X increased miles = \$X.XX.

(d) **Shorter Haul.** If the back-up primary Disposal Facility is closer to the transfer Station than is the primary Disposal facility, then the transport service fee will be decreased to reflect the reduced transport miles as follows:

\$X.XX [INSERT FROM PROPOSAL] transported tons
X decreased miles = \$X.XX.

3. Facility Standards

Director reserves the right to review documentation and inspect facilities in the future and not allow use of facilities that do not meet Director's satisfaction.

4. Processing Facility for E-Waste

CONTRACTOR shall utilize a Processing Facility to Recycle and dismantle all E-waste that it Collects into materials that meet commercial standards for marketable commodities such as metals, plastic, and glass in a facility that operates within the United States. CONTRACTOR shall not ship or utilize a Processing Facility that ships any other E-waste or E-waste components outside the United States. CONTRACTOR shall demonstrate compliance with this subsection in the form of an affidavit from the proposed E-waste recycler.

5. Processing Facility Temporary Equipment or Operational Failure Waiver

a. Notification to the County

The CONTRACTOR, or their Subcontractor (such as a Facility operator), shall notify the COUNTY immediately of any unforeseen operational restrictions that have been imposed upon the designated Solid Waste Facility by a regulatory agency or any unforeseen equipment or operational failure that will temporarily prevent the designated Solid Waste Facility from Processing and recovering different types of Solid Waste such as Recyclables, Organic Waste and Mixed Waste.

The CONTRACTOR or Subcontractor shall notify the COUNTY immediately from the time of the incident. The notification shall include the following: (i) name of designated Solid Waste Facility; (ii) the Recycling and Disposal Reporting System Number of the designated Solid Waste Facility; (iii) date the designated Solid Waste

Facility became unable to Process Recyclables, Organic Waste and Mixed Waste; (iv) description of the operational restrictions that have been imposed upon the designated Solid Waste Facility by a regulatory agency or unforeseen equipment failure or operational restriction that occurred; (v) the period of time the CONTRACTOR anticipates the temporary inability of the designated Solid Waste Facility to Process Recyclables, Organic Waste, or Mixed Waste; (vi) CONTRACTOR's proposed action plan to deliver materials to an Alternative Solid Waste Facility for Processing (Contractor Documentation in Exhibit 17) or CONTRACTOR's request for a waiver to deliver Recyclable, Organic Waste, or Mixed Waste to the designated Solid Waste Disposal Facility.

b. Use of Alternative Facility or Waiver for Disposal of Materials

Upon notification by CONTRACTOR or Subcontractor of the designated Solid Waste Facility's inability to Process materials, COUNTY shall evaluate the notification and determine if County shall require CONTRACTOR to use an alternative Solid Waste Facility or allow the CONTRACTOR to Transport Recyclables, Organic Waste, or Mixed Waste to the designated Solid Waste Facility for Disposal on a temporary basis for a time period specified by the COUNTY. Upon COUNTY's decision, the COUNTY shall notify the CONTRACTOR of its requirement to use an alternative Solid Waste Facility for Processing or to use the designated Solid Waste Facility for Disposal, and the period of time that the COUNTY will allow Recyclables, Organic Waste, or Mixed Waste to be redirected to the alternative Solid Waste Facility or designated Solid Waste Disposal Facility.

Pursuant to 14 CCR Section 18984.13, the approved Disposal period shall not exceed ninety (90) days from the date the Designated Facility's Processing restriction or failure commenced. In such case, the CONTRACTOR must receive written permission from the COUNTY prior to depositing any Discarded material in a landfill.

CONTRACTOR shall maintain a record of any designated Solid Waste Facility incidents and report this information to the COUNTY in accordance with Section 10 Reports.

6. County Designation of Facility

Director reserves the right to direct Solid Waste to a specific site or facility. COUNTY will compensate CONTRACTOR for any direct costs, if any, such as increased tipping fees and transportation costs which CONTRACTOR incurs as a result of the delivery of materials to a COUNTY-designated Solid Waste Facility instead of to the Solid Waste Facility selected by

CONTRACTOR. CONTRACTOR must submit verifiable evidence demonstrating increased costs.

If CONTRACTOR had been using a CONTRACTOR owned facility before being redirected to a different facility, Director will not compensate CONTRACTOR for any lost profits incurred by the CONTRACTOR as a result of being redirected to a different facility. In addition, Director will not compensate CONTRACTOR for any losses incurred to the extent that it had any general obligations to provide a minimum Tonnage to a facility (often referred to as put or pay) but will compensate CONTRACTOR for additional out-of-pocket costs directly resulting from an obligation agreed to specific to this contract. For example, if CONTRACTOR signed an agreement to bring 100,000 tons per month of Refuse to Landfill X, Director will not compensate the CONTRACTOR for redirecting waste under this contract to a different facility. But if CONTRACTOR had agreed to bring 1,000 tons of Refuse from this Service Area to Landfill X, Director will compensate CONTRACTOR for additional out-of-pocket costs that CONTRACTOR incurs as a direct result of being redirected to a different facility.

E. Diversion

1. Reasonable Business Efforts to Divert

CONTRACTOR shall use Reasonable Business Efforts to Divert all Solid Waste that it Collects including Recyclables, Organic Waste, Manure, Bulky Items and E-waste.

2. Changes in Materials

Director may add or delete Recyclable and Organic Waste materials from the definition upon Notice to CONTRACTOR and taking into consideration that the applicable facility where such Recyclables or Organic Waste are delivered by CONTRACTOR accepts such materials added by the Director. Within 14 days of receiving that Notice, CONTRACTOR shall give Director a draft Notice informing Customers of changes in materials. Following COUNTY's approval, CONTRACTOR shall distribute those Notices to Customers and Occupants in the manner that Director requests in accordance with Item I5 of this Exhibit.

CONTRACTOR may request an adjustment to the Service Rates under item A1b of Exhibit 7, Changes in Scope of Service, including submission of documentation supporting the adjustment, to the Director. COUNTY and CONTRACTOR must agree on the adjustment.

Examples of adjustments (or no adjustments) might be:

- No Adjustment

No incremental or net cost of Collection or Processing.

- Possible Adjustment
 - Incremental cost of acquiring new Containers, establishing additional Set-Out Sites, and adding an additional Collection route, not offset by materials sales.
 - Additional cost to Process material.

3. Scavenging - Discouragement

CONTRACTOR shall use Reasonable Business Efforts to enforce the "Collection by Unauthorized Persons" law, pursuant to Public Resources Code Section 41950, et seq., and County Code Chapter 20.72.196 ("anti-scavenging laws"), including the following:

Marking Recyclables Containers with language that the materials are to only be picked up by CONTRACTOR as the "authorized agent" and that CONTRACTOR is picking up the material for Recycling purposes.

CONTRACTOR shall verbally advise any Person that is observed removing Recyclable materials which have been segregated from Solid Waste materials and placed at a designated Collection location for the purposes of Collection and Recycling that such conduct is a misdemeanor, per COUNTY Ordinance, and carries civil penalties.

Instituting civil actions against a Person alleged to have violated California Public Resources Code Section 41950 for treble damages, as measured by the value of the material removed, or a civil penalty of not more than \$2,000, whichever is greater, for each unauthorized removal, in accordance with California Public Resources Code Section 41953(a).

Instituting civil actions against a Person alleged to have violated California Public Resources Code Section 41950 for a second, or subsequent time in a 12-month period, for treble damages, as measured by the value of the material removed, or a civil penalty of not more than \$5,000, whichever is greater, for each unauthorized removal, in accordance with California Public Resources Code Section 41953(b); and

Taking actions under County Code Section 20.72.196 to discourage Scavenging.

4. Prohibition on Mixing Recyclables, Organic Waste, and Refuse

Unless CONTRACTOR is obligated under this CONTRACT or approved by Director to conduct a single-pass service for Customers per item M of Section 4 to Process Refuse for recovery of Recyclables and Organic Waste, or unless as otherwise approved by Director, CONTRACTOR shall not:

- a. Mix the contents Collected from Recyclables, Organic Waste, and Refuse Containers; or*
- b. Dispose of Recyclables or Waste Collected, except for:*
 - (1) Incidental amounts of Recyclables or Organic Waste that an Occupant commingles with discarded Refuse;
 - (2) Contaminated Recyclables or Organic Waste that cannot be Diverted using Reasonable Business Efforts if CONTRACTOR has previously exercised Reasonable Business Efforts to provide Occupant education with respect to reducing that contamination as set forth in the CONTRACTOR's approved Contamination Monitoring Plan submitted in accordance with Contractor Documentation in Exhibit 17.

5. Residuals

a. Minimize Quantity of Residuals

CONTRACTOR shall not use facilities that have a significant quantity of Solid Waste residuals remaining after Processing Recyclables and Organic Waste, as determined by Director, including considering operating and recovery efficiencies and maximum levels of residuals that CalRecycle may establish to qualify the Processing as Diversion.

6. Organic Waste Reduction

CONTRACTOR is required to assist COUNTY to comply with all Applicable Law(s), including SB 1383 which requires the State to achieve Organic Waste Disposal reduction targets.

COUNTY intends to have Organic Waste Diverted from landfills at the start of this CONTRACT. However, COUNTY reserves the right to either delay implementation, stop, or start Organic Waste Diversion at any time. Therefore, if there is a delay or discontinuation of Organic Waste Collection Services, the CONTRACTOR must adjust the Customer's Service Rates and it shall include the Organic Waste waiver discounted rate set forth in Attachment 7-2 of Exhibit 7, Service Rates Schedule.

COUNTY will allow various Collection methods as indicated in 14 CCR Section 18984: Combined Organic Waste Collection Services. CONTRACTOR must submit Collection method proposal along with a corresponding bid price.

7. Organic Waste Processing and Capacity

a. Securing Capacity

CONTRACTOR shall secure adequate, verifiable Diversion capacity to process Organic Waste solely for the CONTRACTOR's Service Area, and in compliance 14 CCR Section 18992.1.

b. Proof of Guaranteed Organic Waste Processing Capacity

CONTRACTOR must provide the COUNTY with a copy of a letter or an agreement from Organic Waste Processing Facility(ies) that Process Organic Waste, to demonstrate proof of guaranteed Organic Waste Processing capacity that has been secured to Process all of the Organic Waste Collected in the CONTRACTOR's Service Area. If the CONTRACTOR owns the facility, CONTRACTOR must provide a letter to the COUNTY that the facility guarantees capacity to Process all of the Organic Waste Collected in the CONTRACTOR's Service Area. This shall be provided by CONTRACTOR in Contractor Documentation in Exhibit 17.

8. SB 1383 Compliance

Facilities to which CONTRACTOR transports Organic Waste must be compliant with SB 1383 requirements in 14 CCR Section 18983.1(b), except that land application is not allowed under this CONTRACT. Land application will only be allowed with written approval by Director due to a lack of other viable facilities.

9. Mixed Waste Processing

If CONTRACTOR utilizes a Mixed Waste Collection method, CONTRACTOR shall transport all Mixed Waste that it Collects to an approved High Diversion Organic Waste Processing Facility designated in Contractor Documentation in Exhibit 17.

CONTRACTOR shall utilize an approved High Diversion Organic Waste Processing Facility that is in compliance with SB 1383 regulations, as defined in 14 CCR Section 18982(a)(33).

F. Special Services

CONTRACTOR shall provide the services prescribed in this Section without additional cost to Customers or charge to COUNTY except for item F4 of this Section, Scout Service.

1. Special Services to Residential and Multifamily Customers

a. Sharps Collection

Within one week of a Customer or Occupant request, CONTRACTOR shall provide the Occupant, without charge, with the following:

(1) Four Sharps Containers per Year

A Sharps Container that has at least a one-gallon capacity (up to four per Contract Year) for discard of Sharps in accordance with any Federal, State, and local laws and regulations; and,

(2) Collect or Pre-Paid Mailer

CONTRACTOR shall also Collect Sharps Container or provide a prepaid postage container for mailing back the approved Sharps Container in accordance with any Federal, State, and local laws and regulations.

CONTRACTOR shall Collect, transport, and Dispose of materials, without charge, in accordance with any Federal, State, and local laws and regulations.

b. Holiday Tree Collection

CONTRACTOR shall Collect, transport, Process, and Divert all holiday trees such as Christmas trees discarded at any Customer's Container Set-Out Site, on or before the Customer's next regularly scheduled Collection day:

(1) During the period beginning December 26 and ending January 14 or

(2) Another period established by COUNTY not to exceed four weeks, and at a Customer's request.

c. Bulky Item Collection

CONTRACTOR must provide the default service which is the Maximum Amount of Collections Per Year (tiered approach) and the Director reserves the right to direct the CONTRACTOR to pick-up an unlimited amount at an adjusted rate as listed on Attachment 7-2, Other Additional Services of Exhibit 7.

Additionally, upon Director request, CONTRACTOR shall Collect any Bulky Items that have been placed at the Customer's Set-Out Site even if the Customer failed to notify CONTRACTOR upon 24 hours in advance. If such Bulky Item materials that are Collected are identified by either the CONTRACTOR or Director to belong to the Customer and/or Occupant of the Premises, CONTRACTOR shall record the Bulky Item Collection incident and count it towards the Customer's Maximum Collection amount allowed per year, as referenced in the chart below.

Service Options:

Maximum Amount of Collections Per Year (Tiered Approach)

CONTRACTOR shall provide a specified maximum amount of Bulky Item pick-ups per year at no charge, depending on the Multifamily Premises and its number of units, as specified in the chart below. This also applies to Residential Customers and are identified under (1) one unit. If the Multifamily Premises and/or the Residential Customer exceeds the maximum Collection pickups amount per year, CONTRACTOR may charge for the additional Bulky Item pickups as indicated Attachment 7-2, Extra Services Fees of Exhibit 7.

SF and MF Premises with Number of Units	Maximum Collection Pickups (no additional cost to Customer)
MF Premises with 150+ units	Up to 50 per year No Charge
MF Premises with 101-149 units	Up to 40 per year No Charge
MF Premises with 50-100 units	Up to 30 per year No Charge
MF Premises with 25-49 units	Up to 20 per year No Charge
MF Premises with 1-24 units *1-unit accounts for a Residential Customer	Up to 10 per year No Charge

CONTRACTOR shall Collect up to ten Bulky Items including textiles, wood, lumber and E-waste as prescribed in subsection d below, upon 24 hours advance request of a Multifamily Customer or Residential Customer

on that Customer's next regularly scheduled Collection day or other date agreed to between that Customer and CONTRACTOR at that Customer's regular Set-Out Site for placing Solid Waste Containers but not in any roadway or other public right of way. For items set out without notice, CONTRACTOR shall not immediately Collect but rather shall perform the following:

- Tag items with a Non-Collection Notice describing Notice requirements, and
- Contact Occupant, by next Service Day as indicated in item A6 under subsection a9 of this Exhibit.
- The following week Collect regardless of Notice by Customer or Occupant.

Unlimited Collection

The COUNTY may require the CONTRACTOR to Collect Bulky Items at unlimited number of times per year from each dwelling unit receiving service, and unlimited quantity of Bulky Items per pickup at an adjusted rate as listed on Attachment 7-2, Other Additional Services of Exhibit 7.

d. Special Recyclable/Reusable Items Collection

In accordance with SB 1383, CONTRACTOR each Calendar Year shall Collect and use Reasonable Business Efforts to Divert the following items along with Bulky Items Collection Services as described in items F1c and F3a of this Exhibit ("Special Recyclable/Reusable Items"):

(1) Textiles

- Clothing - Unlimited quantities of bagged/bundles reusable clothes.
- Other Textiles - Up to five bags/bundles not exceeding 70 pounds of textiles other than reusable clothes.

(2) Wood and Dry Lumber

- Up to two bags/bundles of wood and dry lumber bound or in Containers, not longer than four feet in length or more than 70 pounds in weight and does not contain nails.

(3) E-waste

- Unlimited items of electronic waste that is powered by a plug or battery such as computer, telephones, and televisions.

2. Priority Pickups at Director's Request

Each Calendar Year, CONTRACTOR shall Collect Solid Waste Discarded in the Public Right-of-Way according to circumstances below. Collection requests may be at different locations within the CONTRACTOR's Service Area.

a. *By End of Next Service Day*

CONTRACTOR shall Collect up to 10 times by the end of the next Service Day after Director's request or other time agreed to between Director and CONTRACTOR.

b. *On Same Day*

CONTRACTOR shall Collect up to 5 times on the same day of Director's request or other time agreed to between Director and CONTRACTOR.

c. *Special Cleanup Events Services*

At Director's request, CONTRACTOR shall provide Containers such as Roll-offs, Carts, Dumpsters, Cardboard boxes in type, number, and capacity (up to 80 cubic yards) for discards of Solid Waste for one community cleanup project or public event located throughout the Service Area during any 12-month period. CONTRACTOR may be required to replace filled Containers during the event if directed to do so by Director prior to the event and shall be responsible for removing any Refuse that is left alongside of, rather than inside, the Containers. CONTRACTOR shall Collect Containers at the end of the event, the next day, or other date agreed to between Director and CONTRACTOR. Event participants will be instructed to gather bags into piles at the end of the event. CONTRACTOR shall provide all the necessary staffing, labor, Vehicles, Containers, and other equipment, and materials or supplies (such as plastic bags in portable Containers).

3. Special Services for Commercial Customers

a. *Bulky Item Pickups for Commercial Customers with No Additional Charge*

CONTRACTOR shall collect up to ten Bulky Items including textiles, wood, lumber and E-waste from Commercial Customers no more than six times per Calendar Year at no additional charge. If the

Customer exceeds the six Bulky Item Collections per Calendar Year, CONTRACTOR shall charge for the additional Bulky Item pickups service as stipulated in Attachment 7-2, Extra Services Fees of Exhibit 7.

CONTRACTOR shall Collect Bulky Items including textiles, wood, lumber and E-waste, upon 24 hours advance request of a Commercial Customer who subscribes to Collection Services for Commercial Premises, on that Customer's next regularly scheduled Collection day or other date agreed to between that Customer and CONTRACTOR at that Customer's regular Set-Out Site for placing Solid Waste Containers but not in any roadway or other public right of way.

For items set out without notice, CONTRACTOR shall not immediately Collect but rather shall perform the following:

- Tag items with a Non-Collection Notice describing Notice requirements, and
- Contact Occupant, by next Service Day as indicated in item A5 under subsection a9 of this Exhibit.
- The following week Collect regardless of Notice by Customer or Occupant.

CONTRACTOR shall use Reasonable Business Efforts to Recycle Bulky Items including textiles, wood, lumber, and E-waste.

Additionally, upon Director request, CONTRACTOR shall Collect any Bulky Items that have been placed at the Customer's Set-Out Site even if the Customer failed to notify CONTRACTOR upon 24 hours in advance. If such Bulky Item materials that are Collected are identified by either CONTRACTOR or the Director to belong to the Customer and/or Occupant of the Premises, CONTRACTOR shall record the Bulky Item Collection incident and count it towards the Customer's six Bulky Item Collections allowed per year, as indicated above.

4. Scout Service

CONTRACTOR shall provide Scout Service at the request of the Customer or if necessary and agreed by the Customer. The cost of providing this service shall be stipulated in Attachment 7-2, Extra Services Fees of Exhibit 7.

G. Method of Payment for Collection Services

CONTRACTOR shall bill Customers directly for Collection Services in accordance with items A and B of Section 7.

H. Transition Roll-Out Plan

1. Transition from Non-Exclusive Commercial Franchise System to Exclusive Commercial Franchise System

Upon CONTRACT Execution Date, the CONTRACTOR shall submit a transitional plan within 90 days for transitioning Non-Exclusive Commercial Franchise Customers to the Exclusive Commercial Franchise System. The transition plan shall be designed by the CONTRACTOR and approved by the COUNTY prior to implementation. CONTRACTOR shall submit a plan in accordance with the requirements set forth below and CONTRACTOR shall provide the final approved plan in Contractor Documentation in Exhibit 17.

The Transition Plan shall include:

1. Timelines and tasks for the transition period and process.
2. The coordination plans between the newly awarded CONTRACTOR and the existing operating haulers of the Non-Exclusive Commercial Franchise system.
3. The schedule for the transfer of Customer accounts, including removal or transfer of waste Containers and other equipment, and the replacement of Containers or other equipment to align with new program services and other requirements as stipulated in the CONTRACT. Prior to removing or transferring Collection Containers, the CONTRACTOR shall ensure Customers continue to have Collection Services without disruption in service and shall ensure the Customer has Collection Containers at all times. CONTRACTOR shall adhere to additional requirements set forth under item B6 of Section 2 Term of Contract.
4. The Waste Hauler Welcome Package from the CONTRACTOR to its Customers located in their Service Area including all items listed on the Waste Hauler Welcome Package checklist as indicated in item C of Exhibit 16.

As part of the transition process from the existing Non-Exclusive Commercial Franchise system to the Exclusive Commercial Franchise System the CONTRACTOR shall:

- Assist with the identification and/or removal of unpermitted or unauthorized waste haulers servicing Customers in the County unincorporated communities past the transition period.
- Ensure Customers do not experience a lapse in service .

2. Transition for the Exclusive Commercial Franchise System

At least 30 days Prior to the Execution Date, CONTRACTOR shall provide to Director for approval a transition plan, which shall include both timelines and tasks. CONTRACTOR shall submit a plan in accordance with Contractor Documentation in Exhibit 17, and shall address items such as:

- Ordering Vehicles and/or Containers;
- Vehicle and/or Container delivery from manufacturer;
- Container assembly;
- Distributing Containers to Customers and Occupants;
- Public outreach and education activities;
- Determining routes;
- Training route drivers;
- Collecting old Containers; and

CONTRACTOR shall implement the approved transition roll-out plan for an orderly transition of Solid Waste Collection Services from one contractor to another.

CONTRACTOR shall cooperate and work with outgoing and future contractor of Collection Services to ensure a smooth transition. CONTRACTOR shall agree that if necessary for the orderly transition of Collection Services to:

- Collect Solid Waste from outgoing CONTRACTOR's Containers;
- Allow outgoing CONTRACTOR to Collect from Containers;
- Service, remove, and store outgoing contractor's Containers after transition;
- Allow future CONTRACTOR to Collect from Containers after the termination of CONTRACT; and
- Continue Occupant's services, Container quantity and sizes, and discounts from outgoing CONTRACTOR's customer service list, including not providing Containers to addresses not utilizing outgoing CONTRACTOR's services.

In general, CONTRACTOR should match the service levels provided to Customer/Occupants under the previous contract.

Director shall have the final say to require transition services agreement between outgoing CONTRACTOR and future contractor.

I. Public Education and Outreach

CONTRACTOR shall develop, disseminate, and conduct comprehensive public education and outreach regarding services to maximize Diversion of Recyclables, Organic waste, Bulky items, Sharps, and E-waste. The public education and outreach components shall include the following:

1. Customer Terms and Conditions

Before commencing Collection Services and annually thereafter by July 1, CONTRACTOR shall provide a Terms and Conditions to Customers and Occupants, substantially in the form included in Exhibit 16 and approved by Director. This also includes a Subscription Order Form and Bill of Rights.

CONTRACTOR shall distribute to Customers and Occupants a copy of the Terms and Conditions upon request.

Director may change the form and content of Terms and Conditions after Notice to CONTRACTOR. CONTRACTOR may change the form of Terms and Conditions only with Director's prior written approval in accordance with item B2 of Section 17.

2. Site Visits and Waste Assessments

All Customers shall receive an on-site site visit and waste assessment, by the CONTRACTOR, prior to delivery and service of Containers under this CONTRACT. The purpose of the waste assessment is to capture the materials generated at the Customer location, identify means of increasing waste diversion, and setting goals for future Diversion practices. CONTRACTOR shall provide recommendations to their Customers on reducing, or 'right-sizing', Refuse Collection Services to account for materials diverted through the CONTRACTOR provided Recycling program. Each onsite waste assessment shall include, but is not limited to:

- Pictures of materials discarded in all Containers
- Characteristics of establishment type
- Written recommendations for optimal service levels for Solid Waste Collection (Refuse, Recyclables and Organic Waste), and future Diversion programs or opportunities
- Outreach and education materials appropriate to the establishment type
- On-site training for Commercial Customer's staff, including: management, kitchen staff, service employees, and janitorial staff; and Multifamily Customers' staff, including: the Property Manager,

janitorial staff, maintenance, and any other on-site staff members or contractors that handle Discarded Materials

- Determination of signage placement
- Determination of any on-going training needs
- Determination of any access needs
- Documentation of any special service needs, (i.e., seasonal, automated on-call compactor, etc.)
- Documentation of records of communications with the Customer and/or Occupant.

For each site visit and waste assessment conducted by the CONTRACTOR, the CONTRACTOR shall include documentation of the items listed above. The COUNTY reserves the right to request CONTRACTOR's documentation of additional information and shall authorize the format for required information. The CONTRACTOR shall report all site visit activities as indicated in Section 10 Reports.

3. Ongoing Site Visits and Waste Assessments

The CONTRACTOR, at its own expense, is required to provide a follow-up site visit and waste assessment within one year of the initial site assessment and then subsequent assessments shall be provided every other year. The COUNTY may request site assessments to be provided once per year for select Customers. CONTRACTOR shall follow the site visit and waste assessment requirements as set forth in item I2 above.

4. Outreach and Education for First Customer Visit

In initial contact with Customers, the CONTRACTOR shall provide a Welcome Packet that includes, but is not limited by, the following items:

- Letter from Director
Within 30 days after the Award Date or other date designated by Director, CONTRACTOR shall print and first-class mail Bilingual letters written by Director, notifying Customers and Occupants that the CONTRACT was awarded to CONTRACTOR. CONTRACTOR shall be responsible to pay for the cost of producing and mailing these letters.
- Letter from CONTRACTOR
Within 60 days prior to the Commencement Date or other date designated by Director, CONTRACTOR shall prepare and first-class mail a Bilingual letter to all Customers and Occupants introducing themselves, explaining the transition, and announcing upcoming community meeting dates, and other pertinent information.
- Subscription Order Form including rate schedules (including Extra Services Fees)

- Description of the Los Angeles County Exclusive Commercial Franchise system, including the Collection Service Area, CONTRACTOR name, contact information for billing inquiries location of customer service center
- Customer Bill of Rights and Responsibilities
- Newsletter
- Instructions regarding compliance with the Mandatory Commercial Recycling and Mandatory Commercial Organics Recycling laws, as well as any other waste diversion requirements of state law, including requirements for Source Separating materials into different Containers in accordance with the CONTRACTOR's Collection methods in order to comply with SB 1383 regulations.
- Training document on how to properly sort Organic Waste and Recyclables.
- Los Angeles County's Food DROP Program information including website link

The CONTRACTOR is required to provide these materials that will be developed electronically by the COUNTY and shall be delivered electronically or in print by the CONTRACTOR at the CONTRACTOR's expense. Correspondence distribution method shall be at the sole discretion of the Director.

5. Ongoing Customer Education and Outreach

Annually, the CONTRACTOR, at its own expense, shall disseminate, and conduct comprehensive public education and outreach regarding services to maximize Diversion of Recyclables, Organic Waste (includes Food and Green waste), Bulky items, Sharps, and E-waste. Additionally, at a frequency no more than once per month, the CONTRACTOR is required to disseminate all outreach materials that the COUNTY provides to the CONTRACTOR to distribute to their Customers.

The public education and outreach components shall include the following:

- Collection Method Description
Option 1: For a three-Container or two-Container system: Information on the Customer's requirements to properly separate Recyclables and Organic Waste, or if applicable the Collection of Mixed Waste (Two-Container) and place such materials in appropriate Containers pursuant to this CONTRACT, SB 1383 Regulations, and all other Applicable Law(s).
Option 2: For a one-Container system: Information indicating that the Recyclables and Organic Waste Collected in the Collection Containers are being Processed and recovered at an approved High Diversion Organic Waste Processing Facility.

- Subscription Order Form including rate schedules (including Extra Services Fees).
- Information regarding Self-Hauling requirements such as Self-Haulers must register with the County and submit a self-management plan to the County. Customers may compost Organic Waste on-site or send Organic Waste to a Community Composting operation, they may also utilize a third-party to Collect, transport, or Divert their Organic Waste.
- Information to Customers on the benefits of source reduction and reuse of materials including methods of how to prevent excess Solid Waste generation.
- Information on how Organic Waste is being Diverted by the CONTRACTOR.
- Information regarding the methane reduction benefits of reducing the landfill Disposal of Organic Waste.
- Publications regarding COUNTY's Edible Food donations program, Food DROP, for the donation of Edible Food.
- Reminders of the customer service center location, and COUNTY's customer service phone number and website.

This communication should be given either electronically or in printed form and it may be in the form of a flyer, postcard, or service brochures subject to the review and approval of the COUNTY. Printed outreach materials will be at no more than 5 sheets of paper per outreach material.

6. Bi-annual Newsletter

Twice each year, CONTRACTOR shall prepare promotional and educational newsletters in the bilingual form required by the Director promoting Solid Waste reduction, Recycling, and Organic Waste Diversion. CONTRACTOR shall submit the materials to Director for review during the following seasons:

- (1) Spring/Summer
- (2) Fall/Winter

Such newsletters may be provided by the COUNTY for the CONTRACTOR to distribute to its Customers.

Within 30 days of Director's accepting the materials CONTRACTOR shall distribute them to its Customers, which may be electronically, or upon Customer requests:

- (1) via the U.S. Postal Service with prepaid postage, or
- (2) door-to-door delivery service to Customer's Premises.

7. Education Materials for Property and Business Owners and Tenants

CONTRACTOR shall annually provide Property Owners and Commercial Business owners with public education materials for their distribution to all employees, contractors, tenants, and Customers of the properties and businesses. The CONTRACTOR's public education materials shall include, at a minimum, information about Organic Waste recovery requirements and proper sorting of Discarded materials and shall reflect content requirements described in item 15 of this Exhibit. CONTRACTOR shall provide the following education materials but are not limited to, welcome packets, flyers, and signs. A Commercial Business or Multifamily Property Owner may request these materials more frequently than the standard annual provision if needed to comply with the requirement of 14 CCR Section 18984.10 for Commercial Businesses and Multifamily Property Owners to provide educational information to new tenants and employees before or within fourteen (14) days of occupation of the Premises. In this case, the Commercial Business or Multifamily Property Owner may request delivery of materials by contacting the CONTRACTOR's customer service department by no later than two (2) weeks in advance of the date that the materials are needed.

8. Community Meetings

CONTRACTOR must attend and present at community meetings/events upon Director's request at the hourly rate stipulated in Attachment 7-2, Other Additional Services of Exhibit 7.

Upon Director's sole discretion, the format of the meeting shall be either in-person or over the Internet using a Director-approved software application.

9. Additional Outreach

CONTRACTOR shall visit in-person, call, send an e-mail or text, or other means to inform a Customer or Occupant of services or issues, as requested by Director. For example, CONTRACTOR shall speak to an Occupant that contaminates a Container or frequently leaves a Bulky Item at the Set-Out Site without calling to request Collection.

10. Bilingual Correspondence

CONTRACTOR shall develop all written materials in both English and Spanish and may be requested to provide additional bilingual correspondence up to 4 languages total. Upon COUNTY request, Contractor shall provide materials in additional languages beyond those specified in this Section in response to shifting demographics within the County; updates to State requirements or Applicable Law(s); or any other reason deemed appropriate by the COUNTY.

11. Social Media

CONTRACTOR shall reach out to Customers and Occupants and make information available regarding Contract Services by current social media and the following means approved by Director, such as: Facebook, Twitter, Instagram, and NextDoor.

12. Contractor Assistance with County Educational Efforts

CONTRACTOR acknowledges that they are part of a multi-party effort to operate and educate the public about the County's Municipal Solid Waste (MSW) Management Services. CONTRACTOR shall cooperate and coordinate with the Director on public education activities to minimize duplicative, inconsistent, or inappropriately timed education campaigns. The CONTRACTOR shall cooperate with and shall not impede, interfere, or attempt to impede or interfere with the implementation, expansion, or operation of public education and outreach programs or campaigns conducted by the COUNTY or their designee.

CONTRACTOR shall obtain approval from the Director on all CONTRACTOR-provided public education materials outside of the COUNTY's outreach and education plan, including, but not limited to: print, radio, television, or internet media before publication, distribution, and/or release. The COUNTY shall have the right to request that CONTRACTOR include COUNTY identification and contact information on public education materials and approval of such requests shall not be unreasonably withheld.

J. Additional Services

1. Contamination Monitoring

a. *Collection Route Reviews*

The CONTRACTOR shall implement a Contamination Monitoring Plan in compliance with the requirements of SB 1383 (14 CCR Section 18984.5), the CONTRACTOR must follow and utilize the approved Contamination Monitoring Plan submitted in accordance with item Contractor Documentation in Exhibit 17.

The CONTRACTOR may amend their submitted plan subject to Director approval.

Route Review means a visual inspection of Containers along a hauler route for the purpose of determining container contamination and may include mechanical inspection methods such as the use of cameras.

b. Contamination Noticing

The CONTRACTOR shall follow the same procedures as noted in the Section above, under Contamination Monitoring: Collection Route Reviews, where CONTRACTOR's personnel observed Container Contaminants not solely found during the Collection Route Reviews (i.e., on regular scheduled service routes).

c. Adequate service Level

The CONTRACTOR shall review and make recommendations for the number and size of the Customer's Organic Waste Containers to ensure an adequate level of service for the amount of Organic Waste generated, to ensure proper separation of materials and containment of materials.

d. Reporting Requirements

CONTRACTOR shall maintain records and report to the COUNTY quarterly regarding contamination monitoring activities and actions taken, in accordance with Section 10 Reports.

2. Customer Waiver Requests

a. Inspections for Waiver Qualification

CONTRACTOR shall assist the COUNTY with Customer waiver requests including the following waiver-related responsibilities in a timely manner:

- When requested by their Customer, provide waiver application(s).
- Collect and review waiver application and proof from Customer.
- Determine the Customer's initial qualification for waiver(s) and provide determination(s) to the COUNTY.
- Final Customer waiver qualification shall be determined by the COUNTY. CONTRACTOR shall keep a record of Customer waiver applications, those approved and not approved including proof of circumstances justifying the waiver and the CONTRACTOR's recommendation for approval or disapproval.
- CONTRACTOR shall provide Records as needed (monthly/quarterly), and upon reasonable request related to the Customer's waiver application(s).

- CONTRACTOR shall retain records of waiver applications and approvals for a minimum of three years.

b. Waiver Terms and Additional Information

- Customer waivers may be valid for up to five years unless otherwise stated
- Waivers may be revoked or cancelled without cause by the COUNTY.
- The COUNTY holds the right make final decisions on approval of a waiver. Including conducting additional assessments to ensure waiver applicability.
- The COUNTY may stop offering waivers or add new waivers at any time without notice.
- The COUNTY retains the right to amend waiver requirements. Amendments to waiver requirements may be applied to existing approved waivers resulting in different approval determinations.
- Customers may submit a waiver application only once per year for approval for each type of waiver. If a waiver was not approved, then a waiver application may not be resubmitted for that same Customer, location, and waiver type, until one year after the date on the denial notice. Multiple applications may not be submitted by different Persons for the same waiver type for same account or property.

c. Customer Waiver Types and Qualifications

(1) De Minimus (Available to Commercial Accounts Only)

Section 18984.11 of the SB 1383 Regulations allows a Commercial Customer to waive their Organic Waste subscription if they produce little to no Organic Waste.

To qualify a Commercial Customer must fall under one of the following thresholds and provide any necessary documentation or supporting evidence:

1. The Commercial Customer produces MORE than 2 cubic yards of Refuse per week and produces LESS than 20 gallons of Organic Waste (green container) or Recyclables (blue container) per week.
2. The Commercial Customer produces LESS than 2 cubic yards of Refuse per week and produces LESS than 10 gallons of Organic Waste (green container) or Recyclables (blue container) per week.

Change in Customers' Service Levels

For those Customers that have been granted a waiver, the CONTRACTOR shall notify the COUNTY if the Customer has exceeded the above thresholds within (7) Service Days. Upon receiving approval from the COUNTY, the CONTRACTOR shall modify the Customer's service level by the next Collection day and shall incorporate the new rate for the new service level in their next billing statement.

(2) Physical Space (Available to Commercial or Multifamily Accounts Only)

Allows a Commercial Customer or Multifamily property (of five units or more) to waive their Organic Waste subscription in either a Three-Container or Two-Container Collection system, if the Commercial property or Multifamily property lacks adequate space for a separate Organic Waste Container.

- CONTRACTOR shall first investigate and pursue other ways to comply with Organic service requirements prior to approving a Physical Space Waiver, including but not limited to, consulting with the Customers to adjust their service levels to accommodate an Organic Waste Container.
- Approved Physical Space Waivers as a result of an enclosure's size shall be flagged and reported to the COUNTY.
- CONTRACTOR shall demonstrate proof of inadequate space for a separate Organic Waste Container by means of photographs; additional proof may be requested by the COUNTY.

3. Emergency Services

CONTRACTOR shall provide Municipal Solid Waste (MSW) Management Services requested by COUNTY in health and safety emergencies (such as an earthquake, storm, or riot, or when Solid Waste is accumulating at set-out sites for more than a week). CONTRACTOR shall charge COUNTY no more than what CONTRACTOR charges its Customers for the same frequency and capacity of service, unless Director authorizes different charges upon request of and cost substantiation by CONTRACTOR. Upon request of COUNTY, CONTRACTOR shall give COUNTY, California or Federal officials information that is related to cost of providing the emergency services (such as number or amount of Vehicles, fuel, employees, Tonnage and Disposal fees).

4. Procurement of Recovered Organic Waste Products

CONTRACTOR shall assist the COUNTY in meeting the procurement obligations for SB 1383's Procurement of Recovered Organic Waste Products. Contractor shall ensure recovered Organic Waste products are made from California, as defined in 14 CCR Section 18982(a)(60). CONTRACTOR must follow and utilize the approved plan for the Procurement of Recovered Organic Waste Products as submitted in accordance with Contractor Documentation in Exhibit 17.

CONTRACTOR shall maintain records of all procurement activities and shall report this information in accordance with Section 10 Reports.

K. CONTRACTOR Commitments Made in Proposal

CONTRACTOR shall fully and timely satisfy any additional Performance Obligations set forth in Contractor Documentation in Exhibit 17, from its proposal to Director for procurement of this CONTRACT.

L. Difficult to Service Areas

If CONTRACTOR is unable to Collect Refuse, Recyclables, Organic Waste with a standard automated Collection Vehicle, CONTRACTOR shall use an alternative size or type of Vehicle as necessary including manual or other form of Collection to ensure Collection Services. Additionally, CONTRACTOR may be able to use a standard Collection Vehicle but the rate of Collection is significantly slower, in which case also may use an alternative Vehicle. Areas that are difficult to service include those with narrow streets, alleys and bridges, one-way narrow streets, steep roadway gradients, limited roadway curve radii (tight curve), thin pavement thicknesses, unimproved (dirt) roadway surfaces, and variable vertical and horizontal clearances.

For Customers that are located in difficult to Service Areas, CONTRACTOR must submit to the Director a written request for use of a non-automated Collection Vehicle to provide Collection Services. The CONTRACTOR must provide the Director supporting documentation which should include Customer addresses, route maps, and/or pictures justifying this request. The COUNTY shall review and approve or deny such request, in its sole discretion. If approved, CONTRACTOR may be able to use an alternative Vehicle such as a non-automated Collection Vehicle to provide Collection Services and may charge the Customer a difficult to service fee per the rate schedule in Attachment 7-2 Extra Services Fees of Exhibit 7.

EXHIBIT 5 – Additional Contract Obligations

PART 1 - GENERAL CONTRACT REQUIREMENTS

A. Employment Eligibility Verification

1. CONTRACTOR warrants that it fully complies with all Federal and State statutes and regulations regarding the employment of aliens and others and that all its employees performing work under this CONTRACT meet the citizenship or alien status requirements set forth in Federal and State statutes and regulations. CONTRACTOR shall obtain, from all covered employees performing services hereunder, all verification and other documentation of employment eligibility status required by Federal and State statutes and regulations including, but not limited to, the Immigration Reform and Control Act of 1986 (P.L. 99-603), or as they currently exist and as they may be hereafter amended. CONTRACTOR shall retain all such documentation for all covered employees for the period prescribed by law.
2. CONTRACTOR shall defend and hold harmless, COUNTY of Los Angeles, its Special Districts, Elected Officials, Officers, Agents, Employees, and Volunteers sanctions and any other liability which may be assessed against CONTRACTOR or COUNTY or both about any alleged violation of Federal or State statutes or regulations pertaining to the eligibility for employment of Persons performing services under this CONTRACT.

B. Security and Background Investigations

Security and background investigations of CONTRACTOR's staff may be required at the discretion of COUNTY as a condition of beginning and continuing work under any resulting CONTRACT. The cost of background checks is the responsibility of CONTRACTOR.

C. Consideration of Hiring COUNTY Employees

Should CONTRACTOR require additional or replacement personnel after the effective date of this CONTRACT to perform the services set forth herein, CONTRACTOR shall give first consideration for such employment openings to qualified permanent COUNTY employees who are targeted for layoff or qualified, former COUNTY employees who are on a reemployment list during the life of this CONTRACT.

D. Conflict of Interest

No COUNTY employee whose position with COUNTY enables such employee to influence the award of this CONTRACT or any competing contract, and no spouse or economic dependent of such employee shall be employed in any capacity by CONTRACTOR or have any other direct or indirect financial interest in this

CONTRACT. No officer or employee of CONTRACTOR who may financially benefit from the performance of the work hereunder shall in any way participate in COUNTY's approval, or ongoing evaluation, of such work, or in any way attempt to unlawfully influence COUNTY's approval or ongoing evaluation of such work.

CONTRACTOR represents and warrants that it is aware of, and its authorized officers have read, the provisions of County Code, Section 2.180.010, "Certain Contracts Prohibited," and that execution of this CONTRACT will not violate those provisions. CONTRACTOR shall comply with all conflict of interest laws, ordinances, and regulations now in effect or hereafter to be enacted during the Term of this CONTRACT. CONTRACTOR warrants that it is not now aware of any facts that create a conflict of interest. If CONTRACTOR hereafter becomes aware of any facts that might reasonably be expected to create a conflict of interest, it shall immediately make full written disclosure of such facts to COUNTY. Full written disclosure shall include, but is not limited to, identification of all Persons implicated and a complete description of all relevant circumstances. Failure to comply with the provisions of this paragraph shall be a material breach of this CONTRACT subjecting CONTRACTOR to either contract termination for default or debarment proceedings or both. CONTRACTOR must sign and adhere to the "Conflict of Interest Certification" (Form PW-5).

E. Fair Labor Standards Act

CONTRACTOR shall comply with all applicable provisions of the Federal Fair Labor Standards Act and shall Indemnify, defend, and hold harmless COUNTY, its Special Districts, Elected Officials, Officers, Agents, Employees, and Volunteers from all liability, including, but not limited to, wages, overtime pay, liquidated damages, penalties, court costs, and attorneys' fees arising under any wage and hour law, including the Federal Fair Labor Standards Act, for work performed by CONTRACTOR's employees for which COUNTY may be found jointly or solely liable.

F. Consideration of Hiring GAIN and GROW Participants

- a. Should CONTRACTOR require additional or replacement personnel after the effective date of this Contract, CONTRACTOR shall give consideration for any such employment openings to participants in COUNTY's Department of Public Social Services Greater Avenues for Independence (GAIN) Program and General Relief Opportunity for Work (GROW) Program who meet CONTRACTOR's minimum qualifications for the open position. For this purpose, consideration shall mean that CONTRACTOR will interview qualified candidates. COUNTY will refer GAIN and GROW participants by category to CONTRACTOR. CONTRACTORS shall report all job openings with job requirements to: GAINGROW@dpss.lacounty.gov and BSERVICES@wdacs.lacounty.gov and DPSS will refer qualified GAIN/GROW job candidates.

- b. In the event that both laid-off COUNTY employees and GAIN and GROW participants are available for hiring, COUNTY employees shall be given first priority.

G. Record Retention and Inspection/Audit Settlement

CONTRACTOR shall maintain accurate and complete financial Records of its activities and operations relating to this CONTRACT in accordance with generally accepted accounting principles. CONTRACTOR shall also maintain accurate and complete employment and other Records relating to its performance of this CONTRACT. CONTRACTOR agrees that COUNTY, or its authorized representatives, shall have access to and the right to examine, audit, review Records, excerpt, copy, or transcribe any pertinent transaction, activity, or record relating to this CONTRACT. All such material, including, but not limited to, all financial Records, bank statements, cancelled checks, or other proof of payment, timecards, sign-in/sign-out sheets, and other time and employment Records, and proprietary data and information, shall be kept and maintained by CONTRACTOR and shall be made available to COUNTY during the Term of this CONTRACT and for a period of five years thereafter unless COUNTY's written permission is given to Dispose of any such material prior to such time. All such material shall be maintained by CONTRACTOR at a location in COUNTY, provided that if any such material is located outside COUNTY, then, at COUNTY's option, CONTRACTOR shall pay COUNTY for travel, per diem, and other costs incurred by COUNTY to examine, audit, review Records, excerpt, copy, or transcribe such material at such other location.

1. If a review of Records of CONTRACTOR is conducted specifically regarding this CONTRACT by any Federal or State auditor, or by any auditor, reviewer, or accountant employed by CONTRACTOR or otherwise, then CONTRACTOR shall file a copy of such review of Records Report with COUNTY's Auditor-Controller within 30 days of CONTRACTOR's receipt thereof, unless otherwise provided by applicable Federal or State law or under this CONTRACT. Subject to applicable law, COUNTY shall make a reasonable effort to maintain the confidentiality of such review of Records Report (s).
2. Failure on the part of CONTRACTOR to comply with any of the provisions of this paragraph shall constitute a material breach of this CONTRACT upon which COUNTY may suspend or terminate for default or suspend this CONTRACT.
3. If, at any time during the Term of this CONTRACT or within five years after the expiration or termination of this CONTRACT, representatives of COUNTY conduct a review of Records of CONTRACTOR regarding the work performed under this CONTRACT, and if such review of Records finds that COUNTY's dollar liability for any such work is less than payments made by COUNTY to CONTRACTOR, then the difference shall be either: a) repaid

by CONTRACTOR to COUNTY by cash payment upon demand or b) at the sole option of COUNTY's Auditor-Controller, deducted from any amounts due to CONTRACTOR from COUNTY, whether under this CONTRACT or otherwise. If such review of Records finds that COUNTY's dollar liability for such work is more than the payments made by COUNTY to CONTRACTOR, then the difference shall be paid to CONTRACTOR by COUNTY by cash payment, provided that in no event shall COUNTY's maximum obligation for this CONTRACT exceed the funds appropriated by COUNTY for this CONTRACT.

H. Compliance with COUNTY's Jury Service Program

1. Jury Service Program

This CONTRACT is subject to the provisions of COUNTY's ordinance entitled CONTRACTOR Employee Jury Service (Jury Service Program) as codified in Sections 2.203.010 through 2.203.090 of County Code.

2. Written Employee Jury Service Policy

- a. Unless CONTRACTOR has demonstrated to COUNTY's satisfaction either that CONTRACTOR is not a "CONTRACTOR" as defined under the Jury Service Program (Section 2.203.020 of County Code) or that CONTRACTOR qualifies for an exception to the Jury Service Program (Section 2.203.070 of County Code), CONTRACTOR shall have and adhere to a written policy that provides that its Employees shall receive from CONTRACTOR, on an annual basis, no less than five days of regular pay for actual jury service. The policy may provide that Employee deposit any fees received for such jury service with CONTRACTOR or that CONTRACTOR deduct from the Employee's regular pay the fees received for jury service.
- b. For purposes of this Section, "CONTRACTOR" means a Person, partnership, corporation, or other entity which has a contract with COUNTY or a subcontract with a COUNTY contractor and has received or will receive an aggregate sum of \$50,000 or more in any 12-month period under one or more COUNTY contracts or subcontracts. "Employee" means any California resident who is a full-time employee of CONTRACTOR. "Full-time" means 40 hours or more worked per week, or a lesser number of hours if: 1) the lesser number is a recognized industry standard as determined by COUNTY, or 2) CONTRACTOR has a long-standing practice that defines the lesser number of hours as full-time. Full-time employees providing short-term, temporary services of 90 days or less within a 12-month period are not considered full-time for purposes of the Jury Service Program. If CONTRACTOR uses any Subcontractor to perform services for COUNTY under this CONTRACT, the

Subcontractor shall also be subject to the provisions of this Section. The provisions of this Section shall be inserted into any such subcontract CONTRACT and a copy of the Jury Service Program shall be attached to the CONTRACT.

- c. If CONTRACTOR is not required to comply with the Jury Service Program when this CONTRACT commences, CONTRACTOR shall have a continuing obligation to review the applicability of its "exception status" from the Jury Service Program, and CONTRACTOR shall immediately notify COUNTY if CONTRACTOR at any time either comes within the Jury Service Program's definition of "CONTRACTOR" or if CONTRACTOR no longer qualifies for an exception to the Jury Service Program. In either event, CONTRACTOR shall immediately implement a written policy consistent with the Jury Service Program. COUNTY may also require, at any time during this CONTRACT and at its sole discretion, that CONTRACTOR demonstrate to COUNTY's satisfaction that CONTRACTOR either continues to remain outside of the Jury Service Program's definition of "CONTRACTOR" and/or that CONTRACTOR continues to qualify for an exception to the Jury Service Program.
- d. CONTRACTOR's violation of this Section of this CONTRACT may constitute a material breach of this CONTRACT. In the event of such material breach, COUNTY may, in its sole discretion, suspend or terminate this CONTRACT and/or bar CONTRACTOR from the award of future COUNTY contracts for a period consistent with the seriousness of the breach.

I. CONTRACTOR's Charitable Activities Compliance

The Supervision of Trustees and Fundraisers for Charitable Purposes Act regulates entities receiving or raising charitable contributions. The "Nonprofit Integrity Act of 2004" (SB 1262, Chapter 919) increased Charitable Purposes Act requirements. By requiring CONTRACTOR's to complete the Charitable Contributions Certification (Form PW-12), COUNTY seeks to ensure that all COUNTY CONTRACTOR's which receive or raise charitable contributions comply with California law to protect COUNTY and its taxpayers. A CONTRACTOR which receives or raises charitable contributions without complying with its obligations under California law commits a material breach subjecting it to either contract termination for default or debarment proceedings or both. (County Code Chapter 2.202)

J. Social Enterprise Preference Program

This CONTRACT is subject to the provisions of COUNTY's ordinance entitled Social Enterprise (SE) Preference Program, as codified in Chapter 2.205 of County Code.

CONTRACTOR shall not knowingly and with the intent to defraud, fraudulently obtain, retain, attempt to obtain or retain, or aid another in fraudulently obtaining or retaining or attempting to obtain or retain certification as a SE.

CONTRACTOR shall not willfully and knowingly make a false statement with the intent to defraud, whether by affidavit, Report, or other representation, to a COUNTY official or employee for the purpose of influencing the certification or denial of certification of any entity as a SE.

If CONTRACTOR has obtained COUNTY certification as a SE by reason of having furnished incorrect supporting information or by reason of having withheld information, and which knew, or should have known, the information furnished was incorrect or the information withheld was relevant to its request for certification, and which by reason of such certification has been awarded this contract to which it would not otherwise have been entitled, CONTRACTOR shall:

- Pay to COUNTY any difference between the CONTRACT amount and what COUNTY's costs would have been if the CONTRACT had been properly awarded.
- In addition to the amount described in subdivision (1), be assessed a penalty in the amount of not more than ten percent of the amount of this Contract.
- Be subject to the provisions of Chapter 2.202 of County Code (Determinations of CONTRACTOR Nonresponsibility and CONTRACTOR Debarment).

The above penalties shall also apply to any entity that has previously obtained proper certification, however, as a result of a change in their status would no longer be eligible for certification and fails to notify the Department of Consumer and Business Affairs of this information prior to responding to a solicitation or accepting a contract award.

K. Local Small Business Enterprise Preference Program

This CONTRACT is subject to the provisions of COUNTY's ordinance entitled Local Small Business Enterprise Preference Program, as codified in Chapter 2.204 of County Code.

CONTRACTOR shall not knowingly and with the intent to defraud, fraudulently obtain, retain, attempt to obtain or retain, or aid another in fraudulently obtaining or retaining or attempting to obtain or retain certification as a Local Small Business Enterprise.

CONTRACTOR shall not willfully and knowingly make a false statement with the intent to defraud, whether by affidavit, Report, or other representation, to a COUNTY official or employee for the purpose of influencing the certification or denial of certification of any entity as a Local Small Business Enterprise.

If CONTRACTOR has obtained COUNTY certification as a Local Small Business Enterprise by reason of having furnished incorrect supporting information or by reason of having withheld information, and which knew, or should have known, the information furnished was incorrect or the information withheld was relevant to its request for certification, and which by reason of such certification has been awarded this CONTRACT to which it would not otherwise have been entitled, shall:

- Pay to COUNTY any difference between this CONTRACT amount and what COUNTY's costs would have been if this CONTRACT had been properly awarded.
- In addition to the amount described in subdivision (1), be assessed a penalty in an amount of not more than ten percent of the amount of this CONTRACT.
- Be subject to the provisions of Chapter 2.202 of County Code (Determinations of CONTRACTOR Nonresponsibility and CONTRACTOR Debarment).

The above penalties shall also apply to any business that has previously obtained proper certification, however, as a result of a change in their status would no longer be eligible for certification and fails to notify the State and the Department of Consumer and Business Affairs of this information prior to responding to a solicitation or accepting a contract award.

L. Disabled Veteran Enterprise Preference Program

This CONTRACT is subject to the provisions of COUNTY's ordinance entitled Disabled Veteran Business Enterprise (DVBE) Preference Program, as codified in Chapter 2.211 of County Code.

CONTRACTOR shall not knowingly and with the intent to defraud, fraudulently obtain, retain, attempt to obtain or retain, or aid another in fraudulently obtaining or retaining or attempting to obtain or retain certification as a DVBE.

CONTRACTOR shall not willfully and knowingly make a false statement with the intent to defraud, whether by affidavit, Report, or other representation, to a COUNTY official or employee for the purpose of influencing the certification or denial of certification of any entity as a DVBE.

If CONTRACTOR has obtained certification as a DVBE by reason of having furnished incorrect supporting information or by reason of having withheld information, and which knew, or should have known, the information furnished was incorrect or the information withheld was relevant to its request for certification, and which by reason of such certification has been awarded this contract to which it would not otherwise have been entitled, shall:

- Pay to COUNTY any difference between the CONTRACT amount and what COUNTY's costs would have been if the CONTRACT had been properly awarded.
- In addition to the amount described in subdivision (1), be assessed a penalty in an amount of not more than ten percent of the amount of the CONTRACT.
- Be subject to the provisions of Chapter 2.202 of County Code (Determinations of CONTRACTOR Nonresponsibility and CONTRACTOR Debarment).

Notwithstanding any other remedies in this contract, the above penalties shall also apply to any business that has previously obtained proper certification, however, as a result of a change in their status would no longer be eligible for certification and fails to notify the State and the Department of Consumer and Business Affairs of this information prior to responding to a solicitation or accepting a contract award.

M. CONTRACTOR Responsibility and Debarment

1. Responsible CONTRACTOR

A responsible CONTRACTOR is a contractor who has demonstrated the attribute of trustworthiness as well as quality, conditions, capacity, and experience to satisfactorily perform the CONTRACT. It is COUNTY's policy to conduct business only with responsible contractors.

2. Chapter 2.202 of County Code

CONTRACTOR is hereby notified that, in accordance with Chapter 2.202 of County Code, if COUNTY acquires information concerning the performance of CONTRACTOR on this or other contracts which indicates that CONTRACTOR is not responsible, COUNTY may, in addition to other remedies provided in this CONTRACT, debar CONTRACTOR from bidding or proposing on, being awarded, and/or performing work on COUNTY contracts for a specified period of time, which generally will not exceed 5 years but may exceed 5 years or be permanent if warranted by the circumstances, and suspend or terminate any or all existing contracts CONTRACTOR may have with COUNTY.

3. Nonresponsible CONTRACTOR

COUNTY may debar a CONTRACTOR if the Board finds, in its discretion, that CONTRACTOR has done any of the following: (1) violated any Term of a contract with COUNTY or a nonprofit corporation created by COUNTY; (2) committed an act or omission which negatively reflects on CONTRACTOR's quality, condition, or capacity to perform a contract with

COUNTY, any other public entity, or a nonprofit corporation created by COUNTY, or engaged in a pattern or practice which negatively reflects on same; (3) committed an act or offense which indicates a lack of business integrity or business honesty; or (4) made or submitted a false claim against COUNTY or any other public entity.

4. Contractor Hearing Board

- a. If there is evidence that CONTRACTOR may be subject to debarment, Public Works will notify CONTRACTOR in writing of the evidence which is the basis for the proposed debarment and will advise CONTRACTOR of the scheduled date for a debarment hearing before Contractor Hearing Board.
- b. Contractor Hearing Board will conduct a hearing where evidence on the proposed debarment is presented. CONTRACTOR and/or CONTRACTOR's representative shall be given an opportunity to submit evidence at that hearing. After the hearing, Contractor Hearing Board will prepare a tentative proposed decision, which shall contain a recommendation regarding whether CONTRACTOR should be debarred, and, if so, the appropriate length of time of the debarment. CONTRACTOR and Public Works shall be provided an opportunity to object to the tentative proposed decision prior to its presentation to the Board of Supervisors.
- c. After consideration of any objections, or if no objections are submitted, a record of the hearing, the proposed decision, and any other recommendation of Contractor Hearing Board shall be presented to the Board. The Board of Supervisors shall have the right to modify, deny, or adopt the proposed decision and recommendation of Contractor Hearing Board.
- d. If a CONTRACTOR has been debarred for a period longer than five years, that CONTRACTOR may, after the debarment has been in effect for at least five years, submit a written request for review of the debarment determination to reduce the period of debarment or terminate the debarment. COUNTY may, in its discretion, reduce the period of debarment or terminate the debarment if it finds that CONTRACTOR has adequately demonstrated one or more of the following: (1) elimination of the grounds for which the debarment was imposed; (2) a bona fide change in ownership or management; (3) material evidence discovered after debarment was imposed; or (4) any other reason that is in the best interests of COUNTY.
- e. Contractor Hearing Board will consider a request for review of a debarment determination only where (1) CONTRACTOR has been debarred for a period longer than five years; (2) the debarment has

been in effect for at least five years; and (3) the request is in writing, states one or more of the grounds for reduction of the debarment period or termination of the debarment, and includes supporting documentation. Upon receiving an appropriate request, Contractor Hearing Board will provide Notice of the hearing on the request. At the hearing, Contractor Hearing Board shall conduct a hearing where evidence on the proposed reduction of debarment period or termination of debarment is presented. This hearing shall be conducted and the request for review decided by Contractor Hearing Board pursuant to the same procedure as for a debarment hearing.

- f. Contractor Hearing Board's proposed decision shall contain a recommendation on the request to reduce the period of debarment or terminate the debarment. Contractor Hearing Board shall present its proposed decision and recommendation to the Board of Supervisors. The Board of Supervisors shall have the right to modify, deny, or adopt the proposed decision and recommendation of Contractor Hearing Board.

5. Subcontractors of CONTRACTOR

These terms shall also apply to Subcontractors of COUNTY CONTRACTORS.

N. Reporting Requirements for Improper Solicitations

CONTRACTOR shall immediately report any attempt by a COUNTY officer or employee to solicit improper consideration. CONTRACTOR shall make the Report either to COUNTY manager charged with the supervision of the employee or to COUNTY Fraud Hotline at (800) 544-6861 or www.lacountyfraud.org. Among other items, improper consideration may take the form of cash; discounts; service; or the provision of travel, entertainment, or tangible gifts.

O. COUNTY's Quality Assurance Plan

COUNTY or its agent will monitor CONTRACTOR's performance under this CONTRACT on not less than an annual basis. Such monitoring will include assessing CONTRACTOR's compliance with all this CONTRACT's terms and conditions and performance Standards. CONTRACTOR deficiencies which COUNTY determines are significant or continuing and that may place performance of this CONTRACT in jeopardy, if not corrected, will be reported to the Board. The Report will include improvement/corrective action measures taken by COUNTY and CONTRACTOR.

If improvement does not occur consistent with the corrective action measures, COUNTY may suspend or terminate this CONTRACT for default or impose other penalties as specified in this CONTRACT.

P. Local Small Business Enterprise Utilization

When requested by COUNTY, CONTRACTOR shall provide to COUNTY via methods specified by COUNTY, such as submission of electronic live (or dynamic) data on invoices for the prime and all Subcontractors using COUNTY-designated third-Party software system or to a COUNTY approved website, or other means of submitting expenditure information on Subcontractors, including but not limited to the following information: the name, business address and telephone number/e-mail address of each Subcontractor.

In addition, CONTRACTOR shall be required to provide each of the specified Subcontractor Local Small Business Enterprise (SBE), Disabled Veteran Business Enterprise (DVBE), and Social Enterprise (SE) status (i.e., whether any of the listed Subcontractors are Local SBE's) and the proposed monetary amount of the work the Subcontractor will perform on each Notice to Proceed. At the time of submittal of each invoice, CONTRACTOR shall indicate, via methods specified by COUNTY, the actual dollar amounts paid to each listed Subcontractor who performed work on the project. The Subcontractor may be requested to confirm receipt of the actual payment to the Subcontractor by the prime.

The Parties agree that it will be impracticable or extremely difficult to fix the extent of actual damages resulting from the failure to CONTRACTOR to comply with this Section. The Parties will agree that under the current circumstances a reasonable estimate of such damages is specified in Exhibit F, Performance Requirements Summary, and that CONTRACTOR shall be liable to COUNTY for said amount.

If in the judgment of Director, or his/her designee, CONTRACTOR is deemed to be in non-compliance with the terms and obligations, Director or his/her designee, at his/her option, in addition to, or in lieu of, other remedies provided in Exhibit F, Performance Requirements Summary, may deduct and withhold liquidated damages from COUNTY's final payment to CONTRACTOR.

Q. Compliance with COUNTY's Zero Tolerance Human Trafficking

CONTRACTOR acknowledges that COUNTY has established a Zero Tolerance Human Trafficking Policy prohibiting contractors from engaging in human trafficking.

If a CONTRACTOR or member of CONTRACTOR's staff is convicted of a human trafficking offense, COUNTY shall require that CONTRACTOR or member of CONTRACTOR's staff be removed immediately from performing services under the CONTRACT. COUNTY will not be under any obligation to disclose confidential information regarding the offenses other than those required by law.

Disqualification of any member of CONTRACTOR's staff pursuant to this paragraph shall not relieve CONTRACTOR of its obligation to complete all work in accordance with the terms and conditions of this CONTRACT.

R. Method of Payment and Required Information

The County may, at its sole discretion, determine the most appropriate, efficient, secure, and timely form of payment for any amounts due for goods and/or services provided under a Contract with the County. Proposers/Contractors further agree that the default form of payment shall be EFT or direct deposit, unless an alternative method of payment is deemed appropriate by the A-C.

Upon Contract award and at the request of the A-C and/or Public Works, the Contractor shall provide the A-C with electronic banking and related information for the Contractor and/or any other payee that the Contractor designates to receive payment pursuant to this Contract. Such electronic banking and related information includes, but is not limited to: bank account number and routing number, legal business name, valid taxpayer identification number or TIN, a working e-mail address capable of receiving remittance advices and other payment related correspondence, and any other information that the A-C determines is reasonably necessary to process the payment and comply with all accounting, recordkeeping, and tax reporting requirements.

Any provision of law, grant, or funding agreement requiring a specific form or method of payment other than EFT or direct deposit shall supersede this requirement with respect to those payments. Upon Contract award or at any time during the duration of the Contract, a Contractor may submit a written request for an exemption to this requirement. Such request must be based on specific legal, business or operational needs and explain why the payment method designated by the A-C is not feasible and an alternative is necessary. The A-C, in consultation with Public Works, shall decide whether to approve exemption requests.

S. Compliance with Fair Chance Employment Practices

Contractor shall comply with fair chance employment hiring practices set forth in California Government Code Section 12952, Employment Discrimination: Conviction History. Contractor's violation of this paragraph of the Contract may constitute a material breach of the Contract. In the event of such material breach, County may, in its sole discretion, terminate the Contract.

T. Compliance with the County Policy of Equity

The Contractor acknowledges that the County takes its commitment to preserving the dignity and professionalism of the workplace very seriously, as set forth in the County Policy of Equity (CPOE) (<https://ceop.lacounty.gov/>). The contractor further acknowledges that the County strives to provide a workplace free from

discrimination, harassment, retaliation and inappropriate conduct based on a protected characteristic, and which may violate the CPOE. The Contractor, its employees and Subcontractors acknowledge and certify receipt and understanding of the CPOE. Failure of the Contractor, its employees or its Subcontractors to uphold the County's expectations of a workplace free from harassment and discrimination, including inappropriate conduct based on a protected characteristic, may subject the Contractor to termination of contractual agreements as well as civil liability.

U. Contractor Independence

A Contractor or its subsidiary or Subcontractor (Contractor), is prohibited from submitting a bid or proposal in a County solicitation if the Contractor has provided advice or consultation for the solicitation. A Contractor is also prohibited from submitting a bid or proposal in a County solicitation if the Contractor has developed or prepared any of the solicitation materials on behalf of the County. A violation of this provision shall result in the disqualification of the Contractor from participation in the County solicitation or the termination or cancellation of any resultant County contract. This provision shall survive the expiration, or other termination of this CONTRACT.

V. Contractor Alert Reporting Database (CARD)

The County maintains databases that track/monitor Contractor performance history. Information entered into such databases may be used for a variety of purposes, including determining whether the County will exercise a contract term extension option.

W. Federally Funded Work

This provision will apply when federally funded or potentially federally funded work is needed by County. In accordance with Federal Executive Order 12549 and 12689 (Debarment and Suspension), individuals or entities that have been debarred by the Federal government may not receive work under this Contract as a Contractor or Subcontractor. Contractors and/or Subcontractors listed on the governmental exclusions in the System for Award Management (SAM) are not eligible to receive federally funded work under this contract. See Office of Management and Budget guidelines at 2 CFR 180 that implement Executive Orders 12549 (3 CFR part 1986 Comp., p. 189) and 12689 (3 CFR part 1989 Comp., p. 235), "Debarment and Suspension". The SAM exclusions contains the names of parties debarred, suspended, or otherwise excluded by Federal agencies as well as parties declared ineligible under statutory or regulatory authority.

For federally funded work, the Contract Manager will, before assigning work to the Contractor, verify that the Contractor is not listed on the governmental exclusions in the SAM as a party excluded or ineligible by Federal agencies to participate in federally funded projects. For your reference, a List of Debarred Contractors by

U.S. Department of Labor's (DOL) Office of Federal Contract Compliance Programs (OFCCP) may be obtained by going to the following website: <https://www.sam.gov/portal/SAM/>.

If the Contractor is listed on the governmental exclusions in the SAM as a party excluded or ineligible by Federal agencies to participate in federally funded projects, then said Contractor will not be offered the work. The Contract Manager will notify the Contractor of their negative standing in the SAM. The Contract Manager will also notify the Contractor of their ineligibility to receive any federally funded work under this contract, until the Contractor is able to satisfactorily correct the issue. The Contractor shall notify the Contract Manager when the Contractor has corrected their negative standing in the SAM, and the Contractor is no longer listed on the governmental exclusions in the SAM.

If the Contractor is **not** listed on the governmental exclusions in the SAM as a party excluded or ineligible by Federal agencies to participate in federally funded projects, Public Works may offer said Contractor the federally funded work.

The Contractor is required to verify that its subcontractors are not listed on the governmental exclusions in the SAM, before assigning federally funded work to its subcontractors.

PART 2 - INDEMNIFICATION AND INSURANCE

A. Indemnification and Release of COUNTY

CONTRACTOR shall release, Indemnify, defend, and hold harmless COUNTY and County's Related Parties from and against all Liabilities arising from, connected with, or relating to all the following:

1. Operations

CONTRACTOR and Contractor's Related Parties' operations or any of their respective services on or after the date of this CONTRACT, including the Contract Services and Liabilities further detailed in the following Indemnifications contained in Part 2A2 through Part 2A5 of this Exhibit 5, but excluding any Liabilities arising from the sole active negligence or willful misconduct of COUNTY.

2. Cal/OSHA

Without limiting the operations Indemnification in Part 2A1 of Exhibit 5, employer sanctions and any other Liabilities that may be assessed against CONTRACTOR or COUNTY or both about any alleged act or omission of CONTRACTOR or any of Contractor's Related Parties that is in violation of any Cal/OSHA regulation. This obligation includes all investigations and proceedings associated with purported violations of 8 CCR 336.10 pertaining to multiemployer work sites. CONTRACTOR shall not be obligated to so release, Indemnify, defend, and hold harmless COUNTY from and against any Liabilities arising from the sole active negligence or willful misconduct of COUNTY.

3. Immigration

Without limiting the operations Indemnification in Part 2A1 of Exhibit 5, employer sanctions and any other Liabilities that may be assessed against CONTRACTOR, any of Contractor's Related Parties or COUNTY or any one or all of them about any alleged violation of Federal Applicable Law (including the Immigration Reform and Control Act of 1986 (PL. 99-603) pertaining to the eligibility for employment of individuals performing Contract Services. CONTRACTOR shall not be obligated to so Indemnify, release, defend, and hold harmless COUNTY from and against any Liabilities arising from the sole active negligence or willful misconduct of COUNTY.

4. Enforcement of CONTRACT or Applicable Law

Without limiting the operations Indemnification in Part 2A1 of Exhibit 5, any Liabilities that may be assessed against CONTRACTOR, any of Contractor's Related Parties or COUNTY or any one or all of them about any alleged failure of COUNTY to exercise COUNTY's rights under this CONTRACT or

to enforce provisions of this CONTRACT or of Applicable Law as permitted under Part 7A4 of Exhibit 5, except for any Liabilities arising from the sole active negligence or willful misconduct of COUNTY.

5. Disposal

The presence, Disposal, placement, migration, leakage, spillage, discharge, release, or emission of Unpermitted Waste, petroleum or any other Solid Waste to, in, on, at, or under any Vehicle, place, site, or facility where CONTRACTOR or any of Contractor's Related Parties transports, delivers, stores, processes, Recycles, Composts or Disposes of Solid Waste to the extent that Liabilities are caused indirectly or directly by any of the following:

a. CONTRACTOR Negligence or Misconduct

The wrongful, willful, or negligent act, error or omission, or the misconduct of CONTRACTOR or any of Contractor's Related Parties; wrongful, willful, or negligent act, error, omission, or misconduct includes but is not limited to the Disposal, placement, leakage, spillage, discharge, release, or emission of Unpermitted Waste, petroleum or any other Solid Waste onto a place not designated or approved for Disposal or Processing of said Unpermitted Waste, petroleum, or Solid Waste.

b. Non-Customer Materials

The Collection, delivery, handling, Recycling, Processing, Composting or Disposal by CONTRACTOR or any of Contractor's Related Parties of any materials or waste, including Unpermitted Waste, that are generated by Persons other than Customers and Occupants or Collected from Premises other than Premises;

c. Failure to Comply with Unpermitted Waste Screening Protocol

The failure of CONTRACTOR or any of Contractor's Related Parties to undertake Unpermitted Waste training procedures required by Applicable Law or the Unpermitted Waste Screening Protocol, whichever is more stringent; or

d. CONTRACTOR-Identified Unpermitted Waste

The improper or negligent Collection, handling, delivery, Processing, Recycling, Composting, or Disposal by CONTRACTOR or any of Contractor's Related Parties of Unpermitted Waste that CONTRACTOR or any of Contractor's Related Parties inadvertently Collects from Customers and Occupants and that CONTRACTOR or

any of Contractor's Related Parties identifies as Unpermitted Waste before its delivery, Processing, Recycling, Composting, or Disposal whether:

- (1) In one or more occurrence;
- (2) Threatened or transpired;
- (3) CONTRACTOR or any of Contractor's Related Parties is negligent or otherwise culpable; or
- (4) Those Liabilities are litigated, settled, or reduced to judgment.

For purposes of this item A5, "Liabilities" includes Liabilities arising from or attributable to any operations, repair, cleanup, or detoxification, or preparation and implementation of any removal, remedial, response, closure, post-closure, or other plan, regardless of whether undertaken due to government directive or action, such as remediation of surface or ground water contamination and replacement or restoration of natural resources.

The foregoing Indemnification under this item A5 is intended to operate as a CONTRACT under 42 U.S.C. Section 9607(e) and California Health and Safety Code Section 25364, to insure, protect, hold harmless, and Indemnify COUNTY from liability in accordance with this Section.

The mere presence of household hazardous waste in the Solid Waste that is Collected by CONTRACTOR or any of Contractor's Related Parties under this CONTRACT will not constitute negligence and in and of itself create any liability on the part of CONTRACTOR or any of Contractor's Related Parties absent any of the circumstances described in items a through d in this item A5.

With respect to COUNTY's defense under this item A5, COUNTY reserves the right to retain co-counsel at its own cost and expense and CONTRACTOR shall direct CONTRACTOR's counsel to assist and cooperate with COUNTY'S co-counsel.

CONTRACTOR hereby releases and shall not seek contribution or compensation of any nature from COUNTY for Liabilities relating to Unpermitted Waste, including relating to RCRA, CERCLA, or the California Health and Safety Code. CONTRACTOR shall not make any claims against or assert an interest in any account, fund, or reserve that COUNTY may establish or set aside from the proceeds of the Franchise Fee or otherwise or maintains to cover Liabilities relating to Unpermitted Waste, which established fund or reserve COUNTY is under no obligation to establish or maintain.

B. Insurance

Without limiting its Indemnities, and in the performance of this CONTRACT and until all its Performance Obligations pursuant to this CONTRACT have been met, CONTRACTOR shall provide and maintain the following programs of insurance at its own expense. Performance Obligations under this Section are in addition to and separate from any other Performance Obligation in this CONTRACT. COUNTY reserves the right to review and adjust the insurance requirements in this Section if COUNTY determines that there have been changes in risk exposures. COUNTY makes no warranty that the insurance coverage terms, types, and limits in this Part 2B is sufficient to protect CONTRACTOR for Liabilities that may arise from or in relation to this CONTRACT.

1. Primary, Excess, Non-Contributory

All CONTRACTOR's insurance carried under this Part 2B shall be primary with respect to any other insurance or self-insurance programs available to COUNTY.

2. Cancellation Notices

All insurance shall contain the express condition that COUNTY is to be given written Notice by mail at least 30 days in advance of cancellation, or at least ten days in advance of cancellation for nonpayment of premium, for all policies evidenced on the certificate of insurance.

3. Noncompliance

Neither COUNTY'S failure to obtain, nor COUNTY'S receipt of, or failure to object to a noncomplying insurance certificate or endorsement or any other insurance documentation or information provided by CONTRACTOR, its insurance broker(s) and/or insurer(s), shall be construed as a waiver of any Performance Obligation under this Part 2B. If CONTRACTOR does not provide and maintain those programs of insurance, COUNTY may purchase required insurance coverage without further Notice to CONTRACTOR, and COUNTY may charge CONTRACTOR any premium costs advanced by COUNTY for that insurance and draw on the Performance Assurance provided by CONTRACTOR.

4. Evidence of Insurance: COIs and copies of policies

At least 30 days prior to the Execution Date and thereafter no less than 10 days prior to each policy renewal and within two business days of any Director request, CONTRACTOR shall deliver a certificate or certificates of insurance or other evidence of coverage acceptable to Director at the address provided for Notices. Certificates or other evidence must:

a. Specifically identify this CONTRACT by name or number

name the insured Party that matches the name of CONTRACTOR executing this CONTRACT; provide the full name of each insurer providing coverage and the insurer's NAIC (National Association of Insurance Commissioners) identification number, and financial rating.

b. Types and limits

Clearly evidence all coverage, types, and limits required in this CONTRACT. Identify standard policy forms or their equivalent. Coverage may consist of a combination of primary and excess policies. Excess policies must provide coverage as broad as ("follow form" over) the underlying primary policies;

c. Cancellation Notice

Contain the express condition that Director is to be given written Notice by mail at least 30 days in advance of cancellation (ten days for nonpayment of premium) for all policies evidenced on the certificate of insurance;

d. List additional endorsements

(1) Additional insured endorsements. Include copies of the additional insured endorsements to General Liability Policy which must add COUNTY and its Special Districts, elected officials, officers, agents, and employees as additional insureds with respect to liability arising out of ongoing and completed Contract Services, and applicable with respect to liability and defense of suits arising out of CONTRACTOR's acts or omissions, whether that liability is attributable to CONTRACTOR or COUNTY. The full policy limits and scope of protection must apply to each of those additional insureds even if those limits or scope exceed the minimum required insurance specifications in this CONTRACT. CONTRACTOR may use an automatic additional insured endorsement if the endorsements meet the requirements of this Part 2B.

(2) Waiver of Subrogation Endorsements. Include copies of subrogation endorsements necessary to effect CONTRACTOR's waiver of its and its insurer(s)' rights of recovery against COUNTY under all insurance under Part 2B, to the fullest extent permitted by law.

e. Deductibles and SIRs

Identify any deductibles or self-insured retention ("SIR") exceeding \$50,000 for Director's approval. CONTRACTOR's policies shall not

obligate COUNTY to pay any portion of any CONTRACTOR deductible or SIRCOUNTY retains the right to require CONTRACTOR to reduce any deductibles or self-insured retention as they apply to COUNTY or to require CONTRACTOR to provide a bond, letter of credit, or certificate of deposit guaranteeing payment of all retained losses and related costs, including expenses, or both, related to investigations, claims administrations, and defense. The bond must be executed by a corporate surety licensed to transact business in the State of California; the letter of credit must be issued by a bank or other financial institution acceptable to Director.

If CONTRACTOR has not reached its SIR maximum, CONTRACTOR shall defend COUNTY in the same manner that insurers would have defended COUNTY under required insurance policies.

f. Signature verification

Include documentation acceptable to Director verifying that the individual signing or countersigning the certificates, and at Director's request, the policies, endorsements, or other evidence of coverage, is authorized to do so and identifies his or her company affiliation and title.

g. Certified Copies of any Policy

COUNTY's request, CONTRACTOR shall Promptly provide COUNTY with complete, certified copies of any policy of insurance that CONTRACTOR must secure and maintain under this CONTRACT.

h. Claims Made/Retroactive Date

The policy retroactive date, which can be identified on any insurance written on claims made basis, which must precede the Execution Date. CONTRACTOR shall maintain any claims made coverage for a period of not less than 3 years following expiration, termination, or cancellation of this CONTRACT.

i. Insured-vs.-insured

Clearly evidence that all liability policies provide cross-liability coverage as would be afforded by the standard ISO (Insurance Services Office, Inc.) separation of insureds provision with no insured-versus-insured exclusions or limitations.

5. Insurer Financial Rating

CONTRACTOR shall secure insurance provided by an insurance company acceptable to COUNTY with a rating by A.M. Best Company of not less than A: VII, unless otherwise approved by COUNTY.

6. Notification of Incidents, Claims, or Suits

CONTRACTOR shall Promptly report the following in writing to Director:

- a. Any accident or incident relating to the Contract Services involving injury or property damage that may result in the filing of an insurance claim, its legal claim, or lawsuit against CONTRACTOR, any Subcontractor, and/or COUNTY;
- b. Any third-Party claim or lawsuit filed against CONTRACTOR arising from or related to Contract Services;
- c. Any injury to a CONTRACTOR employee that occurs on COUNTY property, or,
- d. Any loss, disappearance, destruction, misuse, or theft of COUNTY property, money, or securities entrusted to CONTRACTOR.

CONTRACTOR shall submit its Report on a COUNTY "Nonemployee Injury Report" form available on COUNTY's website at <http://cao.co.la.ca.us/RMB/pdf/NonEmployeeInjuryReport.pdf>.

7. Insurance Coverage Requirements.

CONTRACTOR shall secure and maintain insurance coverage meeting the following requirements:

- a. **General Liability Insurance** (written on ISO policy form CG 00 01 or its equivalent) with limits of not less than the following:

General Annual Aggregate:	\$4 million
Products/Completed Operations Aggregate:	\$4 million
Personal and Advertising Injury:	\$1 million
Each Occurrence:	\$2 million

The general liability policy must provide contractual liability coverage for CONTRACTOR's Indemnification of COUNTY.

- b. **Pollution Liability Coverage** for pollution conditions resulting from transported cargo, with annual limits of not less than \$2 million per occurrence and \$4 million aggregate, covering loss (including cleanup costs) that CONTRACTOR becomes legally obligated to pay as a result of claims for bodily injury, property damage, and cleanup costs

(including expenses required by environmental laws or incurred by Federal, State, or local governments or third Parties) resulting from pollution conditions caused by transported cargo (including waste). For the purpose of this Part 2B7b, "pollution conditions" includes the dispersal, discharge, release, or escape of any solid, liquid, gaseous, or thermal irritant or contaminant (such as smoke, vapors, soot, fumes, acids, alkalis, toxic chemicals, medical waste, and waste materials) into or upon land, any structure on land, the atmosphere, or any watercourse or body of water (including groundwater), provided the conditions are not naturally present in the environment in the amounts or concentrations discovered. The pollution liability coverage must provide contractual liability coverage, by endorsement, if necessary, for CONTRACTOR's Indemnification of COUNTY. CONTRACTOR's general liability policy may be endorsed to provide the required pollution liability coverage.

c. **Automobile Liability Coverage** (written on ISO policy forms CA 00 12 or CA 00 20 or their equivalent) with a limit of liability not less than \$2 million for each accident and endorsed to include pollution liability (written on form CA 99 48 or its equivalent). The insurance must cover all Vehicles used by CONTRACTOR pursuant to its operations and services and the terms of this CONTRACT. CONTRACTORS subject to Federal regulations also shall maintain any other coverage necessary to satisfy State or Federal financial responsibility requirements.

d. **Workers' Compensation and Employers' Liability** insurance providing workers' compensation benefits required by the California Labor Code or by any other State labor law, and for which CONTRACTOR is responsible. In all cases, this insurance must also include Employers' Liability coverage with limits of not less than the following:

(1)	Each accident:	\$1 million
(2)	Disease - policy limit:	\$1 million
(3)	Disease - each employee:	\$1 million

e. **Application of Excess Liability Coverage** CONTRACTORS may use a combination of primary, and excess insurance policies which provide coverage broad as ("follow from" over) the underlying primary policies, to satisfy the required insurance provisions.

8. **Insurance Coverage Requirements for Subcontractors**

CONTRACTOR shall ensure that all Subcontractors performing Contract Services under this CONTRACT secure and maintain the insurance coverage required in Part 2B1 through B7 by providing evidence that either:

- CONTRACTOR is maintaining the required insurance covering the activities of Subcontractors, or
- Subcontractors are maintaining the required insurance coverage.

CONTRACTOR shall provide COUNTY with any Subcontractor request to modify that insurance coverage and get COUNTY approval prior to modification.

C. Compensation for COUNTY Costs

If CONTRACTOR fails to comply with any Performance Obligations, including Indemnification, insurance, and performance assurance and that failure results in any costs to COUNTY, CONTRACTOR shall pay full compensation for all County's Reimbursement Costs.

D. Alternative Risk Financing Programs

COUNTY reserves the right to review and then approve CONTRACTOR's use of self-insurance, risk retention groups, risk purchasing groups, pooling arrangements, and captive insurance to satisfy Performance Obligations under this Part 4B. COUNTY and Persons named as additional insureds under Part 4B4d shall be designated as an Additional Covered Party under any approved program.

PART 3 - SUSPENSION; TERMINATION; DEBARMENT BREACHES AND DEFAULTS

A. Notice of Breach; CONTRACTOR Cure Notice

If Director determines that CONTRACTOR is in Breach, Director may give Notice to CONTRACTOR identifying and describing the Breach.

CONTRACTOR shall remedy the Breach within 30 days from the receipt of Notice unless Director determines that the public health and safety require a shorter period. CONTRACTOR shall remedy a Breach or with respect to the Child Support Compliance Program described in Part 7B of Exhibit 5, 90 days after Notice by the COUNTY's Child Support Services Department. Director will hold a conference with CONTRACTOR within 30 days of CONTRACTOR request. CONTRACTOR may request additional time to correct the Breach, but Director may accept or reject that request at its sole discretion.

B. Contractor Default. The following constitute Contractor Defaults

1. Fraud, Misrepresentation, or Breach of Warranties

CONTRACTOR committed any fraud or deceit or made any intentional misrepresentations in the procurement of this CONTRACT; commits, or attempts to commit, any fraud or deceit upon COUNTY after the Award Date of this CONTRACT; makes any material misrepresentations or breaches any warranties in this CONTRACT (including Attachment 5-8H); or includes any materially false or misleading statement, representation, or warranty in any Record or Report.

2. Insolvency or Bankruptcy

CONTRACTOR becomes insolvent or files a voluntary petition to declare bankruptcy; a receiver or trust is appointed for CONTRACTOR; or CONTRACTOR executes an assignment for the benefit of creditors. CONTRACTOR is deemed to be "insolvent" if it has ceased to pay its debts in the ordinary course of business or cannot pay its debts as they become due, whether CONTRACTOR has committed an act of bankruptcy and whether CONTRACTOR is insolvent within the meaning of the Federal bankruptcy law or not.

3. Failure to Provide Insurance, Bonds

CONTRACTOR does not provide or maintain in full force and effect all insurance and other assurances of its Performance Obligations, including as required under Part 2 of Exhibit 5 and Section 15, or provide evidence of insurance coverage acceptable to Director.

4. Material or Repeated Violation of Applicable Law

a. Any material Violation of Applicable Law

That is not cured to the satisfaction of Director or applicable Regulatory Agency within 30 days of the Notice, assessment, or determination of that Violation of Applicable Law; or

b. Any repeated Violation of Applicable Law

If CONTRACTOR is entitled to and does contest a Notice, assessment, or determination of Violation of Applicable Law by proceedings conducted in good faith, no Contractor Default will be deemed to have occurred until a final decision adverse to CONTRACTOR is entered.

5. Failure to Collect for Seven Days

Unless due to Uncontrollable Circumstances or otherwise approved by Director, CONTRACTOR fails to Collect from all Occupants with respect to Collection Services for seven consecutive calendar days.

6. Failure to Collect for More Than Seven Days

With respect to Collection Services, if due to Uncontrollable Circumstances, CONTRACTOR fails to Collect from all Occupants for a period of more than seven consecutive calendar days.

7. Payments to COUNTY

CONTRACTOR does not timely and fully make any required payment to COUNTY required under this CONTRACT (including payments such as damages or County's Reimbursement Costs):

a. More than twice in any Calendar Year;

b. Within 60 days of Notice by Director that payment is due; or

c. With respect to payment of a shortfall in the Franchise Fees, within 60 days of Notice in accordance with Section 9C.

8. Specified Contractor Defaults

CONTRACTOR Breaches any of the following Sections:

a. Part 7B of Exhibit 5 Child Support Compliance Program

(if not cured within 90 days of Notice given as described in Part 3 of Exhibit 5);

- b. Part 8C1 of Exhibit 5 Compliance with ILO Convention Concerning Minimum Age for Employment;*
- c. Part 8D of Exhibit 5 Nondiscrimination;*
- d. Part 8F of Exhibit 5 County Lobbyist Ordinance; or*
- e. Part 3F of Exhibit 5 Termination for Breach of Warranty to Maintain Compliance with COUNTY's Defaulted Property Tax Reduction Program.*

9. Uncured or Repeated Breach

CONTRACTOR does not timely cure any other Breach in accordance with item A or CONTRACTOR Breaches any of its Performance Obligations repeatedly or habitually, as determined by Director at their sole discretion, if a specific instance of failure or refusal has been previously cured. However, this Contractor Default will be excused for a period of seven days beginning on the first occurrence of that Contractor Default in the event of Uncontrollable Circumstances, if the event materially affects CONTRACTOR's ability to provide Contract Services. Nevertheless, if Uncontrollable Circumstances interrupt Collection, Customers and Occupants may take actions and COUNTY may exercise any of its rights under Section 11. This Contractor Default will not be excused if it continues for a period of more than seven days beginning on the first occurrence of this Contractor Default.

10. Improper Consideration

COUNTY finds that consideration, in any form, was offered or given by CONTRACTOR either directly or through an intermediary to any COUNTY officer, employee, or agent with the intent of securing this CONTRACT or securing favorable treatment with respect to the award, amendment, or extension of this CONTRACT or the making of any determinations with respect to CONTRACTOR's performance under this CONTRACT where that consideration may take any form including cash; discounts; service; or the provision of travel, entertainment, or tangible gifts.

11. Default Under Guaranty

A default exists under the guaranty, if any, provided in the most recent annual public financial Reports and other periodic public financial Reports of CONTRACTOR and, at Director's request, each of its Affiliates and other entities, if any, performing Contract Services or providing Goods or Services; provided however, that if CONTRACTOR did not submit its own financial Reports before the Execution Date of this CONTRACT, it must provide a guaranty in the form provided by Director, by a guarantor

satisfactory to Director, which guarantor must provide its own audited financial Reports;

C. Notice of Contractor Default

1. Effective Immediately

COUNTY may terminate this CONTRACT effective immediately after Notice by Director to CONTRACTOR of any of the following Contractor Defaults:

- a. Any Contractor Default, if COUNTY determines that protection of public health and safety requires immediate suspension or termination;*
- b. A Contractor Default in Part 3B3 of Exhibit 5 (failure to provide insurance, bonds);*
- c. A Contractor Default described in Part 3B4 of Exhibit 5 (material or repeated Violation of Applicable Law, including County Lobbyist Ordinance);*
- d. A Contractor Default described in Part 3B10 of Exhibit 5 (improper consideration).*

1. Effective 30 days

COUNTY may terminate this CONTRACT effective 30 days after Notice by Director to CONTRACTOR of any Contractor Default other than Contractor Defaults listed in this Part 3C1 of Exhibit 5 or termination events effective immediately in Part 3D of Exhibit 5 (suspension or termination of CONTRACT).

2. Effective 15 days

COUNTY may terminate this CONTRACT effective 15 days after Notice by Director to CONTRACTOR of COUNTY's right to terminate this CONTRACT in the event of Criminal Activity in accordance with Part 5I of Exhibit 5 and Part 3D2c of Exhibit 5.

3. Effective Ten days

COUNTY may terminate this CONTRACT effective ten days after Notice given by Director for failure to comply with County Defaulted Property Tax Reduction Program in accordance Part 3F of Exhibit 5.

D. Suspension or Termination of CONTRACT

1. Suspension

Together with any other rights COUNTY may have under this CONTRACT, Director may suspend this CONTRACT, in whole or in part, for a period of 45 days effective immediately upon Notice to CONTRACTOR in any of the following events:

a. *A Contractor Default*

b. *COUNTY Right*

COUNTY exercise of its right to suspend this CONTRACT under Part 5I of Exhibit 5 in the event of Criminal Activity of CONTRACTOR; or

c. *Other*

Any other Contractor Default in Exhibit 3A1.

During that 45-day period CONTRACTOR shall have the opportunity to demonstrate to Director that CONTRACTOR can once again fully perform Contract Services in accordance with this CONTRACT. If CONTRACTOR so demonstrates, COUNTY's right to suspend this CONTRACT will cease and CONTRACTOR may resume providing services. If CONTRACTOR does not so demonstrate, COUNTY may continue the suspension and terminate this CONTRACT and exercise any other rights and remedies under this CONTRACT.

2. Termination

a. *Contractor Default*

COUNTY may terminate this CONTRACT, in whole or in part, upon the occurrence of a Contractor Default and Notice to CONTRACTOR at the times provided in Part 3D3 of this Exhibit 5 (Suspension/Termination for Non-Appropriation of Funds).

b. *Failure to Agree on Service Rate Adjustments*

Notwithstanding the foregoing, COUNTY may terminate this CONTRACT on 6 months' Notice if in the judgment of Director, COUNTY and CONTRACTOR are unable to reach satisfactory CONTRACT to adjust Service Rates in accordance with item A1a(1) of Exhibit 7 for a Change in Law, Service Specifications, or Service Standards after good faith negotiations during a period of at least 30 days.

c. *Criminal Activity*

COUNTY may terminate this CONTRACT upon Notice required in Part 3C of Exhibit 5 if COUNTY exercises its right to terminate this CONTRACT under Part 5I of Exhibit 5 in the event of Criminal Activity of CONTRACTOR.

d. *Annexation/Dissolution of Service Area*

It is understood that in the event annexation or the dissolution of all or a portion of the Service Area, this CONTRACT and all obligations of either of the Parties thereto shall end and CONTRACTOR and COUNTY shall amend this CONTACT to delete the annexed area from the definition of Service Area. Such annexations/dissolution may result from proceedings under the provisions of the act pursuant to which the Service Area was created, by operation of law, resulting from municipal annexation or incorporation, or any other reason.

Upon request of Director, CONTRACTOR shall use Reasonable Business Efforts to cooperate with a local agency with respect to providing Collection Services or MSW Management Services, in the event the Service Area is annexed by that local agency in accordance with Applicable Laws.

COUNTY will provide information regarding any known annexations or incorporations at the proposers/bidder's conference; however, CONTRACTOR is responsible for investigating the Service Area and determining which areas are prone to annexation or incorporation. For example, the City of Santa Clarita has annexed portions of the unincorporated communities of the County of Los Angeles and it is reasonable to expect additional annexations during the Term of this CONTRACT.

3. Suspension/Termination for Nonappropriation of Funds

COUNTY shall not be obligated for CONTRACTOR's performance under this CONTRACT, with respect to County Services under this Exhibit during any of COUNTY's future Fiscal Years unless and until the Board appropriates funds for this CONTRACT in COUNTY's budget for each such future Fiscal Year. If funds are not appropriated for this CONTRACT, then this CONTRACT may be suspended or terminated as of June 30 of the last Fiscal Year for which funds were appropriated. Director will notify CONTRACTOR in writing of any such nonallocation of funds as soon as possible.

4. Suspension/Termination Requirements

a. *Stop Suspended/Terminated Work; Complete Non-Suspended/Terminated*

After receipt of a Notice of suspension or termination and except as otherwise directed by Director, CONTRACTOR shall:

- (1) Stop work under this CONTRACT on the date and to the extent specified in such Notice; and
- (2) Complete performance of such part of the work as shall not have been suspended or terminated by such Notice.

b. *Records Retention*

All material including books, Records, documents, or other evidence bearing on the costs and expenses of CONTRACTOR under this CONTRACT shall be maintained by CONTRACTOR in accordance with Section 9A and Part 1G of Exhibit 5.

c. *Completion of Work*

If this CONTRACT is suspended or terminated, CONTRACTOR shall complete within Director's suspension or termination date contained within the Notice of suspension or termination, those items of work which are in various stages of completion, which Director has advised CONTRACTOR are necessary to bring the work to a timely, logical, and orderly end. Reports, samples, and other materials prepared by CONTRACTOR under this CONTRACT shall be delivered to Director upon request and shall become the property of COUNTY.

d. *Suspension or Termination in Part*

COUNTY may suspend or terminate part of this CONTRACT.

E. CONTRACTOR Responsibility and Debarment

1. Child Support Compliance Program

COUNTY may debar CONTRACTOR from doing business with COUNTY if COUNTY determines after giving Notice and conducting a hearing in accordance with Chapter 2.202 of County Code, which shall apply to this CONTRACT, that CONTRACTOR (or any of its Subcontractors) is not responsible within the meaning of Chapter 2.202 and in accordance with

COUNTY's policy to do business with responsible contractors; CONTRACTOR's failure to comply with the Child Support Compliance Program, as provided in Part 7B of Exhibit 5, may be cause for debarment in accordance with Section 2.200.020 of County Code.

2. County Defaulted Property Tax Reduction Program

COUNTY may debar CONTRACTOR from doing business with COUNTY as provided in Part 3F2 of this Exhibit.

F. Termination For Breach Of Warranty To Maintain Compliance With County Defaulted Property Tax Reduction Program

1. Contractor Default

Failure of CONTRACTOR to maintain compliance with the requirements set forth in Part 7C of Exhibit 5 shall constitute a Contractor Default under Part 3B of Exhibit 5.

2. Termination/Debarment

Without limiting the rights and remedies available to COUNTY under any other provision of this CONTRACT, failure of CONTRACTOR to cure that Contractor Default within ten days of Notice shall be grounds upon which COUNTY may terminate this CONTRACT under Part 3D2a of Exhibit 5 and/or pursue debarment of CONTRACTOR pursuant to County Code Chapter 2.206 and Part 3E2 of Exhibit 5.

PART 4 - TRANSFER OF CONTRACT

A. COUNTY Consent

CONTRACTOR may not transfer this CONTRACT, any Franchise granted under it, or any rights or duties under it, in whole or in part, and whether voluntarily or involuntarily, without COUNTY's prior written consent given at COUNTY's sole discretion. Any transfer or attempted transfer of this CONTRACT, the franchise granted under it or any rights and duties under it, made without COUNTY's consent, at COUNTY's option, will be invalid. COUNTY's consent must be a written amendment to this CONTRACT that is executed by (1) CONTRACTOR and (2) the Board, or if delegated by the Board, Director. Any transfer, with or without consideration for any reason whatsoever without COUNTY's (or Director's, if applicable) express prior written approval, shall be a Breach of this CONTRACT, which may result in the termination of this CONTRACT. In the event of such termination, COUNTY shall be entitled to pursue the same remedies against CONTRACTOR as it could pursue in the event of default by CONTRACTOR. COUNTY may condition consent on payment of amounts specified in Exhibit 3A1 in consideration for the value of good will and intangibles that accrued to COUNTY and Customers and Occupants in the award of this CONTRACT to CONTRACTOR.

"Transfer" means an action (or inaction) that has any of the following direct (or indirect) effects:

1. Control or Ownership of CONTRACTOR

Changing any or all of the following:

- The effective control of CONTRACTOR, or
- Ownership interest of CONTRACTOR (including buyout, merger, acquisition, consolidation, reorganization, recapitalization, stock (re)issuance, voting trust, pooling agreement, escrow arrangement, dissolution, or liquidation (except to Immediate Family or a trust created primarily to benefit members of the Immediate Family) unless CONTRACTOR proves to satisfaction of COUNTY less than 25 percent of ownership interest has changed;

2. Control or Ownership of Contract Service Assets

Changing either or both of the following:

- The effective control.
- The ownership (actual or constructive) of Contract Service Assets

(except for sales or transfers to the Immediate Family or a trust created primarily to benefit the Immediate Family) unless CONTRACTOR proves to satisfaction COUNTY that less than 20 percent of the value of Service Assets has changed ownership.

3. Someone Other Than CONTRACTOR Performing Contract Services

Resulting in someone other than CONTRACTOR performing contract services or assuming the obligation to provide Contract Services (including substitution of someone else by a surety company providing a performance bond, franchise assignment, transfer, conveyance, sublease, or licensing).

For purposes of this definition, an action (or inaction) includes assignment by operation of law, such as insolvency or bankruptcy, making assignment for the benefit of creditors, writ of attachment of an execution levied against this Agreement, appointment of a receiver taking possession of any of CONTRACTOR's tangible or intangible property, or transfer occurring in a probate or other estate proceeding.

“Immediate Family” means parents, grandparents, siblings, children, and grandchildren of individuals having a shareholder or other equity interest in CONTRACTOR as of the Execution Date.

“ownership” means the state or fact of being the direct (or indirect), actual (or constructive) owner of property, including a parent holding corporation owning stock of a subsidiary corporation that in turn owns stock in its own subsidiary corporation(s).

B. **CONTRACTOR Demonstration**

Without obligating Director to give consent, CONTRACTOR shall demonstrate to Director's satisfaction that the proposed transferee has the operational and financial ability to satisfy CONTRACTOR's Performance Obligations.

C. **Payment of COUNTY's Transfer Costs**

1. Transfer Deposit

CONTRACTOR must make any request for Director's consent to a transfer in the manner prescribed by Director. Director may condition consent to any transfer, other than a transfer to an Affiliate of CONTRACTOR, on CONTRACTOR's payment to COUNTY of \$5.00 per Customer. CONTRACTOR shall pay COUNTY a transfer Deposit before Director's consideration of CONTRACTOR's request. COUNTY will return to CONTRACTOR any amounts paid more than the transfer Costs incurred.

2. Additional Transfer Costs

While COUNTY's Processing CONTRACTOR's request for transfer, CONTRACTOR shall further pay COUNTY the difference between the Transfer Deposit and the payment to COUNTY of the \$5.00 per Customer fee for Transfers other than to an Affiliate of CONTRACTOR within 30 days of Director's request therefore, if Director approves the transfer. At CONTRACTOR's request, COUNTY will provide CONTRACTOR access to all Records evidencing the transfer Costs incurred.

D. County's Reimbursement Costs of Enforcement

In addition, CONTRACTOR shall pay County's Reimbursement Costs for fees and investigation costs as COUNTY may deem necessary to enjoin the transfer or to otherwise enforce this provision within 30 days of COUNTY's request therefore.

Any payment by COUNTY to any approved delegate or transferee on any claim under this CONTRACT shall be deductible, at COUNTY's sole discretion, against the claims which CONTRACTOR may have against COUNTY.

PART 5 - GENERAL PROVISIONS

A. Exercise of Options

Parties will exercise any approval, disapproval, consent, judgment, option, discretion, election, opinion, or choice under this CONTRACT, make a requirement under this CONTRACT or interpret this CONTRACT ("Discretionary Action") reasonably. Any mediator, arbitrator, or court must find the Party's exercise to be reasonable. Recognizing the essential public health and safety protections this CONTRACT serves, where this CONTRACT specifically provides that the exercise of any Discretionary Action is in either Party's independent, sole, exclusive, or absolute discretion, control, or judgment, the other Party will not question or challenge the first Party's exercise thereof. Parties will nevertheless exercise their rights and remedies in good faith in accordance with Applicable Law.

B. Independent Status

CONTRACTOR is an independent entity and not an officer, agent, servant, or employee of COUNTY. This CONTRACT is between COUNTY and CONTRACTOR and is not intended, and will not be construed, to create the relationship of agent, servant, employee, partnership, joint venture, or association between COUNTY and CONTRACTOR, including for purposes of workers' compensation. CONTRACTOR is solely responsible for the acts and omissions of its officers, agents, employees, and any Subcontractors. Nothing in this CONTRACT will be construed as creating an arrangement for handling Unpermitted Waste. CONTRACTOR bears the sole responsibility and liability for furnishing workers' compensation and all other benefits required by law to any individual for injuries arising from or connected with Contract Services performed on behalf of CONTRACTOR under this CONTRACT.

C. Damage to Property and Personal Injury

CONTRACTOR shall not cause damage to property or personal injury. At its sole expense, CONTRACTOR shall repair or replace in an attempt to satisfy the owner of damaged property, any physical damage to public or private property and shall reimburse in an attempt to satisfy the injured individual, the cost of any personal injury caused by the negligent or willful acts or omissions of CONTRACTOR. COUNTY may refer all complaints of damage or injury to CONTRACTOR as a matter within CONTRACTOR's sole responsibility. Notwithstanding any Rights COUNTY has for breach of CONTRACT, disputes between CONTRACTOR and Persons as to damage to private pavement or other property or to injury are civil matters between CONTRACTOR and that Person, and the Person may institute suits with respect thereto as allowed by law.

D. Venue

In the event of litigation between the Parties, venue in State of California trial courts will lie exclusively in COUNTY. In the event of litigation in a United States District Court, exclusive venue will lie in the Central District of California.

E. Changes and Amendments

1. Changes following Notice

The following changes in this CONTRACT after the Execution Date will be effective after Notice from Director to CONTRACTOR (or with respect to certain changes referenced in item b, from CONTRACTOR to Director, in accordance with Section 17 item B2, CONTRACTOR Documentation, as consented to by CONTRACTOR:

- a. Changes in the scope of Contract Services and Service Specifications and minimum Service Standards that do not result in a Customer Service Rate adjustment in accordance with Section 3C or change in County Service Rate*
- b. Changes to Exhibit 17 Contractor Documentation*
- c. Changes to Attachment 5-8G Authorized Representative of COUNTY's Director*
- d. Immaterial changes to immaterial Performance Obligations*

2. Written Amendments

The following changes in this CONTRACT after the Execution Date will be effective only upon execution of a written amendment to this CONTRACT, including warranties by the Parties in accordance with Section 14B:

- a. Changes in the scope of Contract Services and Service Standards that result in a Customer Service Rate adjustment in accordance with Section 3C; and*
- b. Material changes to material Performance Obligations (such as the period of performance, payments, or any material Term or condition included in this CONTRACT).*

F. Notices

All Notices required or permitted to be given under this CONTRACT must be in writing with proof of delivery and acknowledgment by recipient. All Notices to COUNTY must be addressed to Director as provided in Attachment 5-8G, on CONTRACTOR letterhead, and signed by authorized representative. All Notices to CONTRACTOR must be addressed to the authorized representative of

CONTRACTOR named in Contractor Documentation in Exhibit 17 (who will be CONTRACTOR's primary contact under this CONTRACT).

COUNTY Notice to CONTRACTOR is deemed effective on the date delivered with evidence of receipt or three days after the date of mailing, as evidenced in proof of mailing and post-marked date on envelope.

Notices of suspension or termination of this CONTRACT may be personally delivered to any individual whose actual knowledge of suspension or termination would be sufficient Notice to CONTRACTOR, including:

1. **An individual, if CONTRACTOR is a sole proprietor;**
2. **Copartner, if CONTRACTOR is a partnership; or**
3. **The president, vice president, secretary, or general manager, if CONTRACTOR is a corporation.**

G. Authorized Representative of Director

COUNTY authorizes Director to make requests or requirements of CONTRACTOR or give approvals under this CONTRACT, excluding consents to transfer or written amendments of this CONTRACT. The authorized representative of Director named in Attachment 5-8G is CONTRACTOR's primary contact under this CONTRACT and can be contacted as provided in Attachment 5-8G. CONTRACTOR shall give that authorized representative a copy of all Notices in accordance with Part 5F of Exhibit 5. From time to time, Director may change Attachment 5-8G by Notice to CONTRACTOR.

H. Authority and Representations; COUNTY Disclaimer

1. COUNTY

COUNTY represents and disclaims as follows:

a. Status

COUNTY is a political subdivision of the State of California.

b. Authority and Authorization

COUNTY has full legal right, power, and authority to execute and deliver this CONTRACT and perform its obligations under this CONTRACT. This CONTRACT has been duly executed and delivered by COUNTY and constitutes a legal, valid, and binding obligation of COUNTY enforceable against COUNTY in accordance with its terms.

2. CONTRACTOR

CONTRACTOR represents and warrants as provided in Attachment 5-8H.

I. Criminal Activity

1. Notice

CONTRACTOR shall immediately give Notice to Director on the occurrence of any convictions of a Criminal Activity or any pleas of "guilty," "nolo contendere," or "no contest" to a Criminal Activity with respect to CONTRACTOR or any of its Contractor Managers (except for Contractor Managers in a Position of Influence). CONTRACTOR shall use Reasonable Business Efforts to immediately give Notice to Director on the occurrence of any convictions or any pleas with respect to CONTRACTOR or any of its Contractor Managers in a Position of Influence, and any of its CONTRACTOR employees who come in direct contact with the residents.

2. CONTRACTOR Cure

Upon the occurrence of any conviction or any plea described in Part 5I1 of Exhibit 5, CONTRACTOR immediately shall do or cause to be done both of the following:

a. Terminate

Terminate from employment or remove from office any offending Contractor Manager who is an individual, or with respect to CONTRACTOR or an Affiliate, the individual or individuals responsible for the Criminal Activity; and

b. Eliminate

Eliminate the participation in management of CONTRACTOR by that Contractor Manager who is an individual or, with respect to CONTRACTOR or an Affiliate, the individual or individuals responsible for the Criminal Activity from any Position of Influence.

3. COUNTY Remedies

COUNTY may suspend or terminate this CONTRACT or may impose other sanctions (which may include financial sanctions or any other condition deemed appropriate short of suspension or termination), as it deems proper, in either or both the following events:

- a. *CONTRACTOR or any Affiliate fails to effectuate the cure described in Part 5I2 of Exhibit 5; or*
- b. *The Criminal Activity is related to this CONTRACT or occurring in COUNTY.*

4. Limitations on Contractor Manager

No Contractor Manager may have previously been convicted of a Criminal Activity or any plea of "guilty," "nolo contendere," or "no contest" to a Criminal Activity.

5. Contractor Documentation

CONTRACTOR shall list all Contractor Managers in Contractor Documentation in Exhibit 17.

J. Delay of Performance Obligations

Immediately upon learning that any actual or potential circumstance is delaying or threatening to delay the timely satisfaction of a Performance Obligation, CONTRACTOR shall give Director a Notice of the delay, including all relevant information, such as identifying the Performance Obligation, circumstance, and duration of the delay, and whether or not CONTRACTOR believes that the delay is due to Uncontrollable Circumstances. CONTRACTOR shall propose a solution for Director approval.

K. Subcontractors

CONTRACTOR shall not engage any Subcontractor in an amount exceeding \$50,000 for any individual Subcontractor without prior Director approval of the Subcontract and Subcontractor. CONTRACTOR is responsible for directing the work of CONTRACTOR's Subcontractors and any compensation due or payable to CONTRACTOR's Subcontractors is the sole responsibility of CONTRACTOR. CONTRACTOR shall ensure that the Subcontractor is able to perform all Performance Obligations under this Contract. CONTRACTOR shall remove any approved Subcontractor for good cause at Director's request. CONTRACTOR shall identify all Subcontractors in Contractor Documentation in Exhibit 17. In its Annual Report, CONTRACTOR shall disclose to Director the name of all Subcontractors, the amount of Goods or Services that each Subcontractor provides to CONTRACTOR, and a description of CONTRACTOR's relationships to each Subcontractor (including ownership interests).

PART 6 - DEFINITIONS AND INTERPRETATION OF CONTRACT

A. Definitions

Defined words in this CONTRACT have the meanings given in Attachment 5-10A.

B. Interpretation and Construction

1. Gender and Plurality

Words of the masculine gender include correlative words of the feminine and neuter genders and vice versa. Words importing the singular number include the plural number and vice versa unless the context demands otherwise. (For example, reference to a defined "Solid Waste Facility" may include reference to more than one facility identified by CONTRACTOR in Contractor Documentation in Exhibit 17.)

2. Headings; Font

Any captions or headings following the Exhibit, Attachment, Section, subsection, paragraph, and other attachments and subdivisions of this CONTRACT that precede the operative text of this CONTRACT are for convenience of reference only and do not control or affect the scope, intent, meaning, construction, interpretation, or effect of this CONTRACT. Any underlined, italicized, bold-faced, upper captioned or other font style is for ease of reading and contract administration only and does not imply relative importance or unimportance of any provision of this CONTRACT.

3. References to Parts

References to Sections refer to Sections of this CONTRACT, unless specified otherwise. References to Exhibits and Attachments refer to Exhibits and Attachments attached to this CONTRACT. Reference to "subsections" refers to the subsections contained in the same Section in which the reference occurs, unless otherwise referenced.

4. Examples

Examples are for purpose of illustration only. If any example is ambiguous, inconsistent, or conflicts with the text that it illustrates, the text governs.

5. Specifics No Limitation on Generalities

The mention of any specific duty or liability imposed on CONTRACTOR may not be construed as a limitation or restriction of any general liability or duty imposed on CONTRACTOR by this CONTRACT or Applicable Law.

6. Exhibits

The exhibits to this CONTRACT, including their attachments, are part of this CONTRACT to the same extent and effect as if included in the text of Sections 1 through 17.

7. Inconsistencies and Conflicts

- a. If any provision of Exhibit 3A1 (Collection Services) is inconsistent or conflicts with Sections 1 through 17 or Exhibit 5 (Additional Contract Provisions) of this CONTRACT or any other Exhibits or Attachments to this CONTRACT, then the provisions of Exhibits 3A1 will govern, and
- b. If any provision of Sections 1 through 17 or Exhibit 5 (Additional Contract Provisions) of this CONTRACT is inconsistent or conflicts with any Exhibit (other than Exhibits 3A1), including Contractor Documentation, then the provision of Sections 1 through 17 or Exhibit 5 of this CONTRACT will govern unless Director determines that it is contrary to the interest of the Parties.

C. Integration

This CONTRACT contains the entire CONTRACT between the Parties with respect to the rights and responsibilities of the Parties under this CONTRACT. This CONTRACT completely and fully supersedes all prior oral and written understandings and contracts between the Parties with respect to those rights and responsibilities.

D. Governing Law

This CONTRACT is governed by, and construed and enforced in accordance with the law of the State of California, without giving effect to the State's principles of conflicts of laws.

E. Severability

If any clause, sentence, provision, subsection, or Section of this CONTRACT or Exhibit to this CONTRACT (an "Contract Provision") is ruled illegal, invalid, nonbinding, or unenforceable by any court of competent jurisdiction, then the Parties will take the following actions:

1. Promptly meet and negotiate a substitute for the CONTRACT Provision and any related amendments, deletions, or additions to other provisions of this CONTRACT, which together effect the Parties' original intent to the greatest extent allowable under Applicable Law; and

2. If necessary or desirable to accomplish preceding item 1, apply to the court that declared the invalidity for a judicial construction of the substituted CONTRACT Provision and any amendments, deletions, or additions to this CONTRACT. Within ten days of Director's request, CONTRACTOR shall pay COUNTY an amount equivalent to 100 percent of the Direct Costs of the application.

The illegality, invalidity, nonbinding nature, or unenforceability of any CONTRACT Provision will not affect any of the remaining provisions of this CONTRACT, and this CONTRACT will be construed and enforced as if the CONTRACT Provision did not exist.

F. Interpretation

This CONTRACT will be interpreted and construed neither for nor against either Party, regardless of the degree to which either Party participated in its drafting. CONTRACTOR acknowledges that it determined to provide Contract Services in the Service Area and to execute this CONTRACT upon CONTRACTOR's own choice and initiative. Each Party represents and warrants that it and its counsel have reviewed this CONTRACT, and the Parties agree that no provision in this CONTRACT will be construed against the drafting Party.

PART 7 - COMPLIANCE WITH LAWS AND REGULATIONS

A. Applicable Law

1. Compliance

CONTRACTOR shall secure and maintain all Permits, licenses, registration, agreements, and comply with all Applicable Laws, including (as required by 13 CCR 2021.1) all applicable air pollution control laws such as Diesel Particulate Matter Control Measure of on-road, heavy-duty, and the Property Tax Reduction Ordinance. No obligation in this CONTRACT may be construed to relieve CONTRACTOR of any obligations imposed by Applicable Law.

CONTRACTOR shall be fully responsible for possessing and keeping current and/or obtaining any required licenses/Permits from the appropriate Federal, State, or local authorities for work to be accomplished under this CONTRACT, including, but not limited to, a valid Waste Collector Permit issued by County Department of Public Health, Green Waste Quarantine Zone compliance agreement from California Department of Food and Agriculture, waste and used tire hauler registration from CalRecycle, and hazardous waste transportation Permit from CalRecycle.

CONTRACTOR shall secure and maintain valid waste and used tire hauler registration therefore in accordance with California Public Resources Code Section 42950 et seq. and any Permit required by Applicable Law for handling E-waste. CONTRACTOR shall transport tires to and Dispose of them at a facility authorized and permitted in accordance with Applicable Law to accept tires. CONTRACTOR shall comply with all applicable regulations governing the recovery of ozone-depleting refrigerants during the Disposal of air conditioning or refrigeration equipment, including 40 C.F.R. Part 82.

2. Referenced Provisions

References in this CONTRACT to provisions or requirements of Applicable Law may not be construed to limit CONTRACTOR's obligation to comply with all provisions of Applicable Law. Those references are intended to facilitate CONTRACTOR's satisfaction of its Performance Obligations and COUNTY's administration and specific enforcement of this CONTRACT and may not be construed to constitute lack of obligation to comply with other provisions or requirements of Applicable Law not specifically referred to or cited in this CONTRACT. If any provision of this CONTRACT is more stringent than Applicable Law, CONTRACTOR shall comply with that provision.

3. Fines and Penalties

CONTRACTOR is solely liable for all fines and penalties that may be imposed on CONTRACTOR or may be due to CONTRACTOR's actions, including fines and penalties that are the result of CONTRACTOR's Violation of Applicable Law (including Permits). CONTRACTOR shall not seek reimbursement from COUNTY, Customers, or Occupants for any fines or penalties.

4. Contractual Obligations

Provisions of Applicable Law are incorporated in this CONTRACT by reference as if set forth fully in this CONTRACT as contractual obligations of CONTRACTOR to COUNTY.

a. Breaches

In addition to or in lieu of prosecuting violations of those provisions as misdemeanors, infractions, or otherwise in the manner provided under Applicable Law, COUNTY may enforce those provisions in the same manner as it may enforce CONTRACTOR's other contractual obligations under this CONTRACT, including specific performance and as Breaches subject to cure in accordance with Part 3A of Exhibit 5. However, COUNTY has no obligation to enforce any Applicable Law.

b. Violation

Violation of Applicable Law is a Contractor Default subject to contest as provided in Part 3B4 of Exhibit 5.

5. COUNTY's Protection of Public Safety, Health, and Welfare

CONTRACTOR acknowledges that COUNTY is authorized to make all necessary and reasonable rules and regulations regarding all aspects of MSW Management Services to protect the public's health, safety, and welfare.

No provision in this CONTRACT is deemed to limit the power of COUNTY to regulate CONTRACTOR or to take any action as COUNTY deems appropriate or necessary in Director's sole and absolute discretion, under COUNTY's police power, including to protect the public's health, safety, and welfare.

6. Compliance with Applicable Law of COUNTY

CONTRACTOR shall comply with Applicable Law of COUNTY subject to possible adjustments in the Service Rates in the event of Changes in Law in accordance with items in Exhibit 7.

B. COUNTY Child Support Compliance Program

As required by COUNTY's Child Support Compliance Program (County Code Chapter 2.200), CONTRACTOR shall fully comply with employment and wage reporting requirements under the Federal Social Security Act (42 U.S.C. Section 653(a) and California Unemployment Insurance Code Section 1088.5. CONTRACTOR shall implement lawfully served wage and earnings withholding orders or COUNTY Child Support Services Department Notices of wage earnings assignment for child, family, or spousal support issued in accordance with California Code of Civil Procedure Section 706.031 and California Family Code Section 5246(b).

C. County Defaulted Property Tax Reduction Program

CONTRACTOR acknowledges that COUNTY has established a goal of ensuring that all individuals and businesses that benefit financially from COUNTY through contract are current in paying their property tax obligations (secured and unsecured roll) to mitigate the economic burden otherwise imposed upon COUNTY and its taxpayers.

Unless CONTRACTOR qualifies for an exemption or exclusion, CONTRACTOR warrants and certifies to the best of its knowledge under Attachment 5-9H, that as of the Execution Date it complies with County Code Chapter 2.206. Unless CONTRACTOR qualifies for an exemption or exclusion, CONTRACTOR shall comply with County Code Chapter 2.206.

PART 8 - LABOR-RELATED PROVISIONS REQUIRED IN COUNTY CONTRACTS

A. Labor Code

CONTRACTOR and its agents and employees are bound by and shall comply with all applicable provisions of the California Labor Code as well as all other Applicable Laws related to labor. By and through its execution of this CONTRACT, CONTRACTOR represents and warrants that it is aware of and understands the provisions of California Labor Code Section 3700, which requires every employer to be insured against liability of Workers' Compensation or to undertake self-insurance in accordance with those provisions before commencing the performance of work under this CONTRACT and agrees to fully comply with those provisions.

B. Notices to Employees

1. Regarding the Federal Earned Income Credit

CONTRACTOR shall notify its employees and shall require each Subcontractor performing Contract Services to notify its employees, that they may be eligible for the Federal Earned Income Credit under the Federal income tax laws. The Notice must be provided in accordance with the requirements set forth in Internal Revenue Service Notice 1015 that CONTRACTOR has attached as Contractor Documentation.

2. Regarding Safely Surrendered Baby Law

CONTRACTOR acknowledges that COUNTY places a high-priority on the implementation of the Safely Surrendered Baby Law (SB 1368).

a. *Fact Sheet*

CONTRACTOR shall notify and provide to its employees and shall require each Subcontractor performing Contract Services to notify and provide to Subcontractors' employees a fact sheet regarding the Safely Surrendered Baby Law, its implementation in COUNTY, and where and how to safely surrender a baby. CONTRACTOR shall print and make available in every facility where its employees are present, including Offices and operation yards, the fact sheet that is available at www.babysafela.org.

b. *Poster*

CONTRACTOR understands that it is COUNTY's policy to encourage all COUNTY contractors to voluntarily post COUNTY's "Safely Surrendered Baby Law" poster in a prominent position at CONTRACTOR's place of business. CONTRACTOR shall also

encourage its Subcontractors to post this poster in a prominent position in the Subcontractors' place of business. COUNTY's Department of Children and Family Services will supply CONTRACTOR with the poster to be used.

3. Regarding Child Support

CONTRACTOR acknowledges that COUNTY places a high priority on the enforcement of child support laws and the apprehension of child support evaders. CONTRACTOR further acknowledges that it is COUNTY's policy to encourage all COUNTY contractors to voluntarily post COUNTY's "L.A.'s Most Wanted: Delinquent Parents List" supplied by COUNTY in a prominent position at their place of business.

4. Time Off for Voting

CONTRACTOR shall notify its employees and shall require each Subcontractor to notify and provide to its employees, information regarding the time off for voting law (Elections Code, Section 14000). Not less than ten days before every Statewide election, every CONTRACTOR and Subcontractors shall keep posted conspicuously at the place of work, if practicable, or elsewhere where it can be seen as employees come or go to their place of work, a Notice setting forth the provisions of Section 14000.

C. Prohibition Against Use of Child Labor

1. Compliance with International Labor Organization Convention Concerning Minimum Age for Employment

CONTRACTOR shall not knowingly sell or supply to COUNTY or Customers and Occupants any products, goods, supplies, or other personal property manufactured in violation of child labor standards set by the International Labor Organization through its 1973 Convention Concerning Minimum Age for Employment (the "Convention Concerning Minimum Age for Employment"). If CONTRACTOR discovers that any products, goods, supplies, or other personal property sold or supplied by CONTRACTOR to COUNTY or any Customer are produced in violation of that Convention, CONTRACTOR shall immediately provide an alternative source of supply that complies with that Convention.

2. Provide COUNTY with Records

At COUNTY's request, CONTRACTOR shall provide documentation satisfactory to COUNTY evidencing the country or countries of origin of any products, goods, supplies, or other personal property CONTRACTOR sells or supplies to COUNTY or any Customer or Occupant relating to Contract Services.

3. Provide COUNTY with Manufacturers' Certification

At COUNTY's request, CONTRACTOR shall provide to COUNTY the manufacturer's certification of compliance with the Convention Concerning Minimum Age for Employment or other all-international child labor conventions.

D. Nondiscrimination

1. Employees

CONTRACTOR and its Affiliates shall employ qualified applicants and treat employees equally without regard to or because of race, color, national origin, ancestry, religion sex, age, physical or mental disability, marital status, or political affiliation and in compliance with all State of California and Federal antidiscrimination laws, including in employment, upgrading, demotion, transfer, recruitment, recruitment advertising, layoff, termination, Service Rates of pay, other forms of compensation, and selection of training (including apprenticeship).

2. Subcontractors, Proposers/Bidders, and Vendors

CONTRACTOR shall deal with its Subcontractors, proposers/bidders, and vendors without regard to or because of race, color, national origin, ancestry, religion, sex, age, physical or mental disability, marital status, or political affiliation.

3. Certification

CONTRACTOR shall comply with the provisions of CONTRACTOR's EEO Certification (Form PW-7), attached as Contractor Documentation.

4. Inspection of Records

At COUNTY's request, CONTRACTOR shall Promptly allow COUNTY and its auditors or reviewer access to CONTRACTOR's employment Records at CONTRACTOR's Office during Contractor Office Hours to verify compliance with the provisions of Part 8D4 of Exhibit 5.

5. Remedies for Discrimination

If COUNTY finds that CONTRACTOR has violated any provisions of this subsection D, that violation constitutes a Contractor Default. While COUNTY reserves the right to determine independently that the antidiscrimination provisions of this subsection D have been violated, in addition, a determination by the California Fair Employment Practices

Commission or the Federal Equal Employment Opportunity Commission that CONTRACTOR has violated State of California or Federal antidiscrimination laws will constitute a finding by COUNTY that CONTRACTOR has violated the antidiscrimination provisions of Part 8D of Exhibit 5.

E. Safety

1. Services Safety Official

CONTRACTOR shall designate in Contractor Documentation in Exhibit 17 a Services Safety Official who shall be thoroughly familiar with CONTRACTOR's Injury and Illness Prevention Program (IIPP) and Code of Safe Practices (CSP). CONTRACTOR shall ensure that the Services Safety Official is available always Contract Services are provided to abate any potential safety hazards. CONTRACTOR shall give the Services Safety Official the authority and responsibility to cease performing any service if necessary to abate any potential safety hazard. If CONTRACTOR fails to designate or make available the Services Safety Official, COUNTY may direct CONTRACTOR to cease providing Contract Services at no cost to COUNTY until CONTRACTOR complies with this Section.

2. Safety Responsibilities

CONTRACTOR is responsible for the safety of equipment, material, and personnel under CONTRACTOR's control or authority during performance of Contract Services. CONTRACTOR is solely responsible for ensuring that all work performed under this CONTRACT is performed in strict compliance with all Applicable Laws with respect to occupational safety regulations. CONTRACTOR shall provide at its expense all safeguards, safety devices, protective equipment, and shall take all actions appropriate to providing a safe job environment.

F. COUNTY Lobbyists

CONTRACTOR and each COUNTY lobbyist or COUNTY lobbying firm as defined in County Code Section 2.160.010, retained by CONTRACTOR shall fully comply with County Lobbyist Ordinance.

ATTACHMENT 5-8G – Authorized Representative of COUNTY’s Director

Name: Clark Ajwani

Telephone Number: (626) 458-5163

E-mail Address: cajwani@pw.lacounty.gov

Address for Notices by Mail:

Los Angeles County Public Works
Environmental Programs Division
P.O. Box 1460
Alhambra, CA 91802-1460

Director’s Office Hours : 7 a.m. to 5:30 p.m. Monday - Thursday
Established by Director

Signature:  _____

Printed Name: Clark Ajwani

Date: 08/17/22

Acknowledged by CONTRACTOR:

Signature:  _____

Printed Name: DAVID PEREZ

Title: PRESIDENT

Date: 9/19/2022

ATTACHMENT 5-8H – CONTRACTOR’s Representations and Warranties

A. Status

CONTRACTOR is duly organized, validly existing and in good standing under the laws of and is qualified to do business in the State of California with full power and authority to execute and deliver this CONTRACT and to perform its Performance Obligations. This CONTRACT has been duly executed and delivered by CONTRACTOR and constitutes a legal, valid, and binding obligation of CONTRACTOR enforceable against CONTRACTOR in accordance with its terms.

B. Statements and Information

All information and documentation compiled, drafted, made, or otherwise delivered to COUNTY by or on behalf of CONTRACTOR relating to this CONTRACT, including its procurement, is correct and complete in all material respects as of the Execution Date and at the time originally submitted by CONTRACTOR to COUNTY.

C. No Conflicts

Neither the execution or delivery by CONTRACTOR of this CONTRACT, the performance by CONTRACTOR of Contract Services, nor the fulfillment by CONTRACTOR of the terms and conditions of this CONTRACT: (1) conflicts with, violates, or results in a breach of any Applicable Law; (2) conflicts with, violates, or results in a breach of any Term or condition of any judgment, order or decree of any court, administrative agency or other governmental authority, or any CONTRACT or instrument to which CONTRACTOR is a Party or by which CONTRACTOR properties or assets are bound, or constitutes a default.

D. No Approvals Required

CONTRACTOR has obtained and maintains all Permits in full force and effect during the Term. No other approval, authorization, license, Permit, order, or consent of, or declaration, registration, or filing with any governmental or administrative authority, commission, board, agency, or instrumentality is required for the valid execution and delivery of this CONTRACT by CONTRACTOR, except those as have been duly obtained from its governing body, CONTRACTOR shall immediately provide Notice to Director of any Notice of violation, revocation, or suspension of any Permit.

E. No Litigation

As of the Execution Date, disclose any action, suit, proceeding, or investigation, at law or in equity, before or by any court or governmental authority, commission, board, agency or instrumentality pending or, to the best of CONTRACTOR’s knowledge, threatened, against CONTRACTOR wherein an unfavorable decision, ruling or finding, in any single case or in the aggregate, would materially adversely

affect the performance by CONTRACTOR of its obligations under this CONTRACT or in connection with the transactions contemplated by this CONTRACT, or which, in any way, would adversely affect the validity or enforce ability of this CONTRACT or any other CONTRACT or instrument entered into by CONTRACTOR relating to the transactions contemplated by this CONTRACT.

F. Due Diligence

As of the Execution Date, CONTRACTOR has made an independent investigation, examination, and research satisfactory to it of the conditions and circumstances surrounding this CONTRACT and best and proper method of providing Contract Services and labor, equipment, and materials for the volume of Contract Services to be provided. CONTRACTOR agrees that it shall make no claim against COUNTY based on any estimates, statements or interpretations made by any officer, employee, agent, or consultant of COUNTY relating to the procurement of this CONTRACT, which proves to be in any respect erroneous.

G. Compliance with Applicable Law

As of the Execution Date, CONTRACTOR has fully complied with all Applicable Law, including (1) law relating to conflicts of interest and County Lobbyist Ordinance, while procuring this CONTRACT, and (2) County Defaulted Property Tax Reduction Program.

H. Ability to Perform

CONTRACTOR possesses the business, professional, and technical capabilities to provide Contract Services; and possesses the equipment, facilities, and employee resources required to fully and timely perform Contract Services.

I. Contingent Fees

No Person, including a selling agency, has been employed or retained to solicit or secure this CONTRACT upon a CONTRACT or understanding for a commission, percentage, brokerage, or contingent fee, excepting bona fide employees or bona fide established commercial or selling agencies maintained by CONTRACTOR for securing business.

J. Opportunity to Comment

CONTRACTOR had the opportunity to submit comments and recommended changes during the procurement process, during meetings convoked by COUNTY with the denominated "Working Group" whose members received copies of the drafts of the form of CONTRACT or during the procurement of this CONTRACT.

K. Solid Waste Facilities

1. The Solid Waste Facility or Facilities that CONTRACTOR designates in Contractor Documentation in Exhibit 17 for Disposal is a Disposal facility that is permitted to accept and Process Refuse in accordance with Applicable Law.
2. The facility or facilities that CONTRACTOR designates in Contractor Documentation in Exhibit 17 for delivery of Recyclables is a materials recovery facility that is permitted to accept and Process Recyclables in accordance with Applicable Law.
3. The facility or facilities that CONTRACTOR designates in Contractor Documentation in Exhibit 17 for delivery of Organic Waste is a facility that is permitted to accept and Process Organic Waste in accordance with Applicable Law.

L. Contractor Documentation

As of the Execution Date, CONTRACTOR has submitted all Contractor Documentation in accordance with Exhibit 17.

M. Personnel

CONTRACTOR fully complies with all Federal and State statutes and regulations regarding employment of aliens and others, and all of its employees performing Contract Services meet the citizenship or alien status requirements set forth in Federal and State statutes and regulations.

ATTACHMENT 5-9A - Definitions

Affiliate means a Person that, directly or indirectly through one or more intermediaries, controls, or is controlled by, or is under common control with CONTRACTOR.

Annual Report is described in item A2 of Section 10.

Applicable Law means all laws, statutes, rules, regulations, guidelines, Permits, licenses, policies, actions, determinations, orders, or requirements of the United States, State of California, COUNTY (including its County Code together with rules and regulations promulgated there under and COUNTY's Integrated Waste Management Plan), the Local Enforcement Agency, California Highway Patrol, South Coast Air Quality Management District, and other regional or local government authorities, agencies, boards, commissions, courts, or other bodies having applicable jurisdiction, that from time to time apply to or govern Contract Services or the performance of the Parties' respective obligations under this CONTRACT, including those that concern health, safety, fire, mitigation monitoring plans, building codes, and zoning, and further including the following:

- Vehicles:
 - California Health and Safety Code Section 43000 et seq., with respect to air emissions (smog checks);
 - California Vehicle Code Section 27456b, with respect to tires;
 - California Vehicle Code Section 34500 et seq., with respect to documentation through its maintenance log or otherwise of a safety compliance report issued under Division 14.8 of the California Vehicle Code as applicable to each Vehicle, including bi-annual "BIT" inspections conducted by the California Highway Patrol;
 - Rules and regulations promulgated under the California Vehicle Code with respect to Vehicle highway lighting, flashing, and warning lights, clearance lights, and warning flags;
 - Rules and regulations of the California Department of Motor Vehicles with respect to Vehicle registration;
 - Vehicle weight limits;
 - The appropriate class of drivers' licenses issued by the California Department of Motor Vehicles;
 - Control Measure for Diesel Particulate Matter from On-road Heavy-Duty Residential and Commercial Solid Waste Collection Vehicles, 13 CCR 2020 et seq.; and
 - 14 CCR 17341, 17342, 17343 and 17344, with respect to equipment construction, safety, and parking and identification of operating equipment;
- Containers:
 - 14 CCR 17314, with respect to maintenance and placement of Containers; and
 - 14 CCR 17317, with respect to placing identifying name and telephone number on Containers;

- Labor:
 - Drug and alcohol testing;
 - Occupational Safety and Health Act (29 U.S.C. Section 651 et seq.), including the Solid Waste Disposal Facility Criteria promulgated by the U.S. EPA on October 9, 1991 (40 C.F.R., Parts 257 and 258); and California Occupational Safety and Health Act (California Labor Code, Division 5, Parts 1-10, Section 6300 et seq.), and rules and regulations of California Division of Occupational Safety and Health; and
 - Immigration Reform and Control Act of 1986 (PL.99-603);
- Environmental Protection:
 - CERCLA;
 - RCRA;
 - Clean Air Act (42 U.S.C. Section 1351 et seq., 42 U.S.C. Section 7401-7642); and California Clean Air Act (California Health and Safety Code Section 39000 et seq.);
 - California Hazardous Waste Control Act (California Health and Safety Code Section 25100 et seq.);
 - California Hazardous Materials Release Response Plan and Inventory Act (California Health and Safety Code, Division 20, Chapter 6.95, Section 25500 et seq.);
 - Carpenter-Presley-Tanner Hazardous Substance Account Act (California Health and Safety Code Section 25300 et seq.); and
 - Emergency Planning and Community Right to Know Act (42 U.S.C. Section 11001 et seq.); and
- Miscellaneous:
 - County Lobbyist Ordinance;
 - County Defaulted Property Tax Reduction Ordinance.
 - Civil Rights Act of 1964 (Subchapter VI of Chapter 21 of Title 42);
 - AB 939;
 - SB 1383; and
 - AB 1826.

Reference to Applicable Law includes future amendments and supplements to or replacement, restatement, or recodification thereof.

Assembly Bill (AB) 939 means the California Integrated Waste Management Act of 1989, California Public Resources Code Section 40000 et seq., and regulations thereunder.

Authorized Exclusive Commercial Franchise Waste Hauler means a waste hauler that has signed a Commercial Franchise agreement with COUNTY and is currently in good standing.

Authorized Residential Franchise Waste Hauler means a waste hauler that has signed a Residential Franchise agreement with COUNTY and is currently in good standing.

Award Date means the date County of Los Angeles Board of Supervisors approves the CONTRACT.

Basic Service Rates means the monthly charges that CONTRACTOR bills a Customer for providing Collection Services, without additional optional services.

Best Efforts mean serious and sizeable efforts that a respectable Person would take in the same (or similar) circumstances, using principles of impartiality of fairness. It will be presumed that the Person intends to meet its obligations in honesty and good faith.

Bilingual means in the languages of English and Spanish or other languages that may be required under Article 4 of SB 1383 or other laws.

Board of Supervisors means the Board of Supervisors of County of Los Angeles.

Breach means CONTRACTOR's failure to fully and timely meet one or more Performance Obligations.

Bulky Item means any large item of Solid Waste that will not fit into an empty Container that can be safely lifted by two individuals using a dolly that has been placed at the Set-Out Site for Collection by CONTRACTOR. A Bulky Item includes, but is not limited to the following:

- Discarded furniture (such as chairs, sofas, mattresses, and rugs);
- Large Appliances (such as refrigerators, ranges, washers, dryers, water heaters, dishwashers, and other similar items commonly known as "white goods");
- Up to two tires from passenger cars or pickup trucks;
- Special Recyclable/Reusable Items (such as textiles, wood/lumber and E-waste), as defined in item F1d of Exhibit 3A1.

Bulky Items excludes items such as:

- Large truck tires;
- Unpermitted Waste;
- Construction and Demolition Debris;
- Piles of debris.

Calendar Year means the months beginning January 1 and ending December 31.

Cart means a wheeled plastic Container provided by CONTRACTOR for storage of Solid Waste pending Collection, which is Collected (semi) by automated Vehicle. Examples include 32, 64, and 96-gallon plastic Containers. Carts are often referred to as barrels. Cart sizes vary depending on the manufacturer, and any reference to Cart sizes in this Agreement are approximations.

CCR means California Code of Regulations.

CERCLA means the Comprehensive Environmental Response, Compensation, and Liability Act of 1982 (42 U.S.C. Section 9601 et seq.).

Change in Law means the occurrence of any event or change in Applicable Law as follows:

- The adoption, promulgation, modification, or change in Applicable Law or in judicial or administrative interpretation thereof occurring after the Execution Date other than laws with respect to taxes based on or measured by net income, or any unincorporated business, payroll, franchise taxes levied by any tax board (other than the Franchise Fees levied by COUNTY) or employment taxes;
- Any order or judgment of any Federal, State, or local court or Regulatory Agency issued after the Execution Date if:
 - That order or judgment is not also the result of the willful misconduct or negligent action or inaction of the Party relying thereon or of any third-Party for whom the Party relying thereon is directly responsible; and
 - The Party relying thereon, unless excused in writing from so doing by the other Party, will make or have made, or will cause or have caused to be made, Reasonable Business Efforts to contest that order or judgment (it being understood that the contesting in good faith of that an order or judgment will not constitute or be construed as a willful misconduct or negligent action of that Party);
- The imposition by a Regulatory Agency of any new or different material conditions about the issuance, renewal, or modification of any Permit after the Execution Date; or
- The failure of a Regulatory Agency to issue or renew, or delay in the issuance or renewal of, or the suspension, interruption, or termination of, any Permit after the Execution Date; if the failure to issue or the suspension or termination of any Permit is not the result of the willful misconduct or negligent action or inaction of the Party relying thereon or any third-Party for whom the Party relying thereon is directly responsible.

Collection Services means all Performance Obligations to Collect Solid Waste at County Commercial Franchise Customer Premises as prescribed in Exhibit 3A1.

Collect, Collection, or Collecting means Solid Waste pickup(s) made by CONTRACTOR required by and in accordance with this CONTRACT.

Commencement Date means the date defined in Item A of Section 2 and is the date Collection Service begins.

Commercial means related to a Person or thing that is not Residential or Multifamily.

Commercial Business means any commercial enterprise or non-profit organization, whether organized as a sole proprietorship, firm, partnership, corporation, non-profit corporation, limited liability company, limited partnership, or business association. The term Commercial Business includes enterprises such as shopping centers and strip malls that lease space to other Commercial Businesses, as well as the Commercial Businesses that lease such space. The term Commercial Business does not include a Residence but

does include a commercial enterprise or non-profit organization that is operated from within a Residence.

Commercial Edible Food Generators includes Tier One Commercial Edible Food Generators and Tier Two Commercial Edible Food Generators, or as otherwise defined in 14 CCR Section 18982(a)(7). For the purposes of this definition, Food Recovery Organizations and Food Recovery Services are not Commercial Edible Food Generators, or as otherwise specified by 14 CCR Section 18982(a)(7).

Compostable Plastics means plastic materials that meet the ASTM D6400 standard for compostability as described in 14 CCR Section 18984.1(a)(1)(A) or 18984.2(a)(1)(C).

Compost means a mixture of decayed or decaying Organic matter (such as leaves and grass) used to amend or fertilize soil.

Construction and Demolition (C&D) Debris means material, other than Unpermitted Waste, including hazardous waste, radioactive waste, or medical waste, that is generated by or results from construction or demolition-related activities including, but not limited to: construction, deconstruction, demolition, excavation, land clearing, landscaping, reconstruction, remodeling, renovation, repair, and site clean-up, as defined in County Code 20.87.030. C&D debris includes, but is not limited to: asphalt, concrete, brick, lumber, gypsum wallboard, cardboard and other associated packaging, roofing material, ceramic tile, carpeting, plastic pipe, steel, rock, soil, gravel, tree stumps, and other vegetative matter. In this Contract, C&D debris is not a type of solid waste.

Container means any Cart, Dumpster, or Roll-Off used to provide Collection Service. It is a receptacle for Organic Waste, Recyclables, and/or Refuse that is located on the site where such material is generated and is intended for the storage of such material before it is collected, Hauled and/or Managed On-Site. The term Container includes stand-alone receptacles as well as sections of divided receptacles or plastic bags that are used to separate different types of material.

Container Contaminants means material that has been deposited into any Container that is not the type of material for which the Container is designated, in contravention of the requirements of an applicable Organic Waste Collection Service.

CONTRACT means this CONTRACT, including all exhibits and other attachments, which exhibits and other attachments are incorporated in this CONTRACT by reference.

Contract Services means all CONTRACTOR's obligations and Services provided to the under this CONTRACT.

Contract Year means each 12-month period commencing on the first day of the month in which CONTRACTOR Collects Solid Waste from any Occupant.

CONTRACTOR means the Person executing this CONTRACT and any assignee of CONTRACTOR consented to by COUNTY in accordance with Section 19.

CONTRACTOR includes CONTRACTOR's Subcontractors unless explicitly provided otherwise. References to all CONTRACTOR's actions and Performance Obligations under this CONTRACT include reference to Subcontractors' actions under this CONTRACT, as applicable, without specifying in each instance that CONTRACTOR shall directly take those actions itself, or cause its Subcontractors to take those actions on CONTRACTOR's behalf.

Contractor Default is described in Part 3 of Exhibit 5.

Contractor Documentation means documentation in Exhibit 17.

Contractor Manager means any of the following:

- The authorized representative of CONTRACTOR named in Contractor Documentation in Exhibit 17.

Contractor Office Hours means 8:00 a.m. to 5:00 p.m. Monday through Friday, except Holidays.

Contractor's Related Parties means CONTRACTOR's partners, officers, directors, agents, employees, Subcontractors, consultants, licensees, invitees, and Affiliates.

Conversion Technology (CT) means an array of technologies capable of converting residual Solid Waste into useful products, including fuels, chemicals, and other sources of clean energy.

COUNTY means the government entity known as County of Los Angeles.

County Commercial Franchise Customers means as specified in item A1 of Exhibit 3A1.

County Business Day means any day on which Los Angeles County Public Works is open to do business with the public.

County Code means the Los Angeles County Code.

County Defaulted Property Tax Reduction Program or **County Defaulted Property Tax Reduction Ordinance** means County Code Chapter 2.206.

COUNTY Lobbyist Ordinance means County Code Chapter 2.160.

County's Reimbursement Costs means Direct Costs of COUNTY plus 35 percent thereof.

County's Related Parties means political subdivisions, agencies, entities, or organizations for which the Board of Supervisors is the governing body, their agents, officers, and employees, elected officials, assigns, volunteers, and special districts

(including Garbage Disposal Districts) and each one of them. County's Related Parties are third-Party beneficiaries of provisions in this CONTRACT that reference them.

CPI means the Consumer Price Index ("CPI"), for Trash and Garbage Collection (CUUR0000SEHG02), U.S. City average, published by the United States Department of Labor, Bureau of Labor Statistics at <https://beta.bls.gov/dataViewer/view/timeseries/CUUR0000SEHG02>

Criminal Activity means any of the following:

- Fraud or criminal felony offenses relating to obtaining, attempting to obtain, procuring, or performing a public or private CONTRACT related to Recyclables, Green Waste or MSW Management Services of any kind (including Collection, hauling, Transfer, Processing, Composting, or Disposal), including this CONTRACT;
- Bribery or attempting to bribe a public officer or employee of a local, State, or Federal agency;
- Embezzlement, extortion, racketeering, false claims, false statements, forgery, falsification or destruction of Records, obstruction of justice, knowingly receiving stolen property, theft, or misprision (failure to disclose) of a felony;
- Unlawful Disposal of hazardous, designated, or other waste; or
- Violation of securities laws or antitrust laws, including laws relating to price-fixing, bid rigging and sales and market allocation, and of unfair and anticompetitive trade practice laws, including with respect to inflation of Solid Waste Collection, hauling or Disposal fees.

Customer means a Person who pays for Collection Services provided by CONTRACTOR.

Customer Bill of Rights means the Customer Bill of Rights included in Contractor Documentation in Exhibit 17.

Customer Subscription Order means Customer Subscription Order Form included in Contractor Documentation in Exhibit 17.

Customer Extra Services Fees means the amounts listed as "Extra Services Fees" found in Attachment 7-2 of Exhibit 7.

Customer Service Rates means the amount that CONTRACTOR bills Customers for providing Collection Services.

Customer Service Rates Schedule is found in Attachment 7-2 of Exhibit 7.

Day means calendar day, whether capitalized or lower case.

Debarment or **Debar** has the meaning assigned in County Code Section 2.202.020.

Direct Costs means the sum of the following but excludes profit or return on investment:

- Payroll costs directly related to the performance, management, or supervision of any obligation under this CONTRACT, or exercise of any right, comprised of compensation and fringe benefits, including vacation, sick leave, Holidays, retirement, Worker's Compensation insurance, Federal and State unemployment taxes and all medical and health insurance benefits, plus;
- The costs of materials, services, direct rental costs, and supplies, plus;
- Travel and subsistence costs, plus;
- The reasonable costs of any payments to Subcontractors (with respect to CONTRACTOR) or contractors (with respect to COUNTY) or third Parties necessary to and about Performance Obligations, plus;
- Any other cost or expense which is directly or normally associated with the task performed; which is substantiated by:
 - A certificate signed by the principal financial officer of CONTRACTOR or the authorized representative of COUNTY setting forth the amount of that cost and the reason that cost is properly chargeable to COUNTY or CONTRACTOR and stating that the cost is a competitive price, if there are competitive prices, secured in an arm's length transaction for the service or materials supplied; and
 - If COUNTY or CONTRACTOR requests additional backup documentation as may be available to reasonably substantiate any Direct Costs, including invoices from suppliers, Subcontractors, and contractors.

Director means COUNTY Director of Public Works or his or her authorized representative, including the authorized representative named in Attachment 5-8G.

Director's Office Hours means hours that Director is open to do business as indicated in Attachment 5-8G.

Disabled means Occupants who suffer from a disability as evidenced by a letter from their medical physician.

Disposal or **Dispose** means Disposal, as defined in California Public Resources Code Section 40192, at a Solid Waste Facility of Refuse that CONTRACTOR has Collected.

District means Garbage Disposal District.

Diversion or **Divert** means activities that reduce or eliminate the amount of Solid Waste from Disposal for the purposes of Division 13 of the California Public Resources Code, including Article 1 (commencing with Section 41780).

Diversion Goal means the current State law requirement of 50 percent, the State goal of 75 percent Diversion by 2025, and future COUNTY goals including the Roadmap to a Sustainable Waste Management Future adopted by the Board of Supervisors on April 22, 2014. The Roadmap goals are 80 percent Diversion from landfills by 2025, 90 percent Diversion from landfills by 2035, and 95 percent or more Diversion from landfills by 2045,

as calculated by Director using Director's methodology. State and COUNTY goals are subject to change.

Dumpster means a container for storage of Solid Waste that is usually Collected with front end loading Vehicles, such as those having a 1- to 8-cubic yard capacity, commonly referred to as a Dumpster. Dumpsters are also often referred to as bins.

Edible Food has the meaning set forth in Title 14, section 18982(a)(18) of the California Code of Regulations and means food that is appropriate for human consumption and that meets the food safety requirements of the California Retail Food Code. For the purposes of this Chapter, Edible Food is not Solid Waste if it is Recovered and not discarded.

Elderly means a Person age 62 or older as evidenced by a driver's license or other document issued by a governmental entity.

E-waste means waste that is powered by batteries or electricity, such as computers, telephones, stereo equipment, DVD players/recorders, mp3 players, televisions, and calculators.

Execution Date means the date this CONTRACT is signed by both COUNTY and CONTRACTOR.

Expiration Date means the date this CONTRACT expires as provided in accordance with item A of Section 2.

Fiscal Year means the 12-month period beginning July 1st and ending the following June 30th.

Franchise Fee means the fee described in item D of Section 1.

Garbage Disposal District means a district created under County Code Chapter 20.90 and referred to as COUNTY in this CONTRACT.

Goods or Services means goods or services used in providing Contract Services, including labor; leases; subleases; equipment; supplies; capital; insurance, bonds, or other performance security if the insurer, surety, or other provider is an Affiliate or a captive of CONTRACTOR or any Affiliate; and legal, risk management, general, and administrative services.

Green Waste means Solid Waste comprised of leaves, grass clippings, brush, branches, nonhazardous wood waste, and other forms of Organic matter generated from landscapes and gardens and separated from other forms of Solid Waste, including Christmas Trees and bushes, but excluding:

- Stumps or branches exceeding four inches in diameter or four feet in length;
- Yucca or palm fronds, unless CONTRACTOR can Divert those excluded materials in non-Composting processes; and

- Other Director-approved items listed in the Terms and Conditions.

Gross Receipts means fees, charges, and other compensation that CONTRACTOR or Contractor's Related Parties receive directly or indirectly from Customers and Occupants about Collection Services before any deduction for costs or expenses such as the Franchise Fee. Gross Receipts does not mean fees, charges, and other compensation that CONTRACTOR or Contractor's Related Parties receive about the sale of Recyclables.

High Diversion Organic Waste Processing Facility means a High Diversion Organic Waste Processing Facility as defined in 14 CCR Section 18982(a)(33). Per SB 1383 Regulations (14 CCR Section 18982(a)(33)), the High Diversion Processing facility is a facility that is in compliance with the reporting requirements of 14 CCR Section 18815.5(d) and meets or exceeds an annual average mixed waste organic content recovery rate of 50 percent (50%) between January 1, 2022 and December 31, 2024, and 75 percent (75%) after January 1, 2025 as calculated pursuant to 14 CCR Section 18815.5(e) for Organic Waste received from the Mixed Waste.

Holidays means January 1, Memorial Day, 4th of July, Labor Day, Thanksgiving, and December 25 and any other Holidays designated by COUNTY in Notice to CONTRACTOR.

HOA means Homeowner Association.

Including or **Include** or variations thereof, when used in this CONTRACT, means "including without limitation," "including, but not limited to," and "including, at a minimum."

Indemnities or **Indemnification** means all defenses, Indemnities, and releases under this CONTRACT, including under Part 2A of Exhibit 5 (generally), and with respect to the Immigration Reform and Control Act and Cal/OSHA (specifically).

Liabilities mean any of the following:

- Liabilities;
- Lawsuits;
- Claims;
- Complaints;
- Cause of actions;
- Citations;
- Investigations;
- Judgments;
- Demands;
- Cleanup orders;
- Damages (whether in contract or tort, including:
 - Personal injury to or death of, at any time, CONTRACTOR's employees, Subcontractors, COUNTY employees or third Parties; and

- Property damage of CONTRACTOR, Subcontractors, COUNTY employees or third Parties);
- Costs and expenses, (including all costs and expenses of litigation, mediation or arbitration, attorneys' fees, whether COUNTY's or CONTRACTOR's staff attorneys or outside attorneys, and court costs);
- Losses;
- Fines;
- Penalties; and
- Other detriments of every nature and description whatsoever, whether under State of California or Federal law.

Liquidated Damages means the amounts due by CONTRACTOR for failure to meet specific quantifiable standards of performance as described in Exhibit 12-D2 Liquidated Damages.

Local Enforcement Agency means the enforcement agency defined in County Code Section 20.56.030.

Management of Organic Waste On-Site or "Manage On-Site" Management of Organic Waste On-Site, or Manage On-Site when used in reference to Organic Waste, means to conduct an operation that converts Organic Waste into a useful product, on the same property or site where the Organic Waste is generated.

Manure means Solid Waste comprised of horse dung or excrement and may include straw or other absorbent.

Maximum Rate Adjustment is described in Section A3 of Exhibit 7.

Micro-Hauler means a Hauler that collects Organic Waste from Organic Waste generators, in limited quantities as determined by the Director, and transports such Organic Waste to a Community Composting facility. A Micro-Hauler must enter into a contract or Franchise with the County in order to be authorized to collect Organic Waste from Organic Waste Generators.

Micro-Haulers are not to provide Organic service to accounts with large Organic service levels. For the purposes of this section, a large Organic service level is equal to or more than one 64-gallon Container Collected weekly. Micro-haulers are not to exceed Collection threshold of 5 tons of Organic Waste per month per Service Area.

Mixed Waste means any type of Solid Waste that contains Organic Waste material must be transported to a High Diversion Organic Waste Processing Facility. If the Solid Waste only contains Recyclables and no Organic Waste, then it shall be transported to a materials recovery facility that recovers Recyclable materials that is mixed with Refuse.

Minimum Default Collection Service includes a minimum base rate for the level of service for Refuse which is agreed upon by the Customer and CONTRACTOR and shall be charged accordingly to the rates set forth in Exhibit 7, Attachment 7-2 (Service Rates).

The Refuse rate will automatically include a subscription of a 64-gallon Cart of weekly Organic Waste Collection and a 96-gallon Cart of weekly Recyclables Collection Service per Customer, both at no additional charge unless the Customer requires service beyond the minimum.

Mulch means Organic materials commonly used for Mulch including wood chips, ground up landscape trimmings, shredded bark, coarse Compost material, and straw.

Multifamily means Person or thing related to (1) dwellings with five or more attached dwelling units (such as apartments), each with separate cooking and bathing facilities, (2) townhouses, and (3) condominiums, whether attached or detached.

Multifamily Premises means Premises containing a Multifamily building.

Municipal Solid Waste (MSW) Management Services means any of the following:

- Collection, transportation, storage, Transfer, or Processing of:
 - Solid Waste; or
 - Unpermitted Waste that is Collected as part of a Collection program for Bulky Items, and E-waste described in Exhibit 3A1 and handled in accordance with Applicable Law (such as tires more than load limits, and certain E-waste); or
- Arranging for Disposal of that Solid Waste or Unpermitted Waste.

Non-Collection Notice means the Notice in the form included in Contractor Documentation in Exhibit 17 in accordance with item A5 of Exhibit 3A1.

Notice (when capitalized) means Notice given in accordance with Part 5F of Exhibit 5.

Occupant means a Person within the Service Area that occupies a Residential, Multifamily or Commercial Premises and receives services from CONTRACTOR.

Office means CONTRACTOR's offices required by item A of Section 6 to be identified in Contractor Documentation in Exhibit 17.

Organic Waste (or **Organics**) means Solid Waste that contains material originating from living organisms and their metabolic waste products, all in accordance with 14 CCR 18982(a)(46) but excluding Unpermitted Waste.

Organic Waste include:

- Green Waste,
- Food Waste,
- Manure,
- Biosolids, digestate, and sludges
- Clean, untreated wood and lumber

Organic Waste are presumed to be source-separated *unless* they are explicitly described as commingled. “Organic Waste” is synonymous with both of the following:

- “Source Separated Organic Waste” in 14 CCR 18982(a)(69), and
- Recyclables that may be allowed to be collected in the green Container such as paper, cardboard, textiles, carpet, lumber, and wood.

Organic Waste Collection Service means a service for the Collection of Organic Waste by an Authorized Hauler, other than a Micro Hauler, that complies with the requirements of a three-Container Collection Service described in Title 14, Section 18984.1 of the California Code of Regulations, a two-Container Collection Service described in Title 14, Section 18984.2 of the California Code of Regulations, or a single Container service as described in accordance with Title 14, section 18984.3 of the California Code of Regulations.

Organic Waste Processing Facility means:

1. A facility, operation or activity described in Title 14, Section 18983.1(b) of the California Code of Regulations, that Recovers or utilizes Organic Waste in a beneficial manner that does not constitute landfill disposal, including:
 - a. A High Diversion Organic Waste Processing Facility;
 - b. A recycling center as defined in Title 14 of the California Code of Regulations, Section 17402.5(d) or that is listed in Title 14 of the California Code of Regulations, Section 17402.5(c);
 - c. A compostable material handling operation or facility as defined in Title 14 of the California Code of Regulations, Section 17852(a)(12), small composting activity that would otherwise be excluded from that definition by Title 14 of the California Code of Regulations, Section 17855(a)(4), or Community Composting;
 - d. An in-vessel digestion operation or facility as listed in Title 14 of the California Code of Regulations, Section 17896.5 or activities that would otherwise not be subject to the in-vessel digestion requirements pursuant to Title 14 of the California Code of Regulations, Section 17896.6;
 - e. Biomass conversion operation or facility as defined in California Public Resources Code Section 40106;
 - f. An operation that uses Organic Waste as soil amendment for erosion control, revegetation, slope stabilization, or landscaping at a landfill when the material is used in a manner that complies with requirements set forth in Title 14 of the California Code of Regulations, Section 18983.1(b)(5);
 - g. An operation that uses Organic Waste as land application, and that complies with the requirements set forth in Title 14 of the California Code of Regulations, Section 18983.1(b)(6);

- h. An operation that uses Organic Waste as animal feed in accordance with Title 14 of the California Code of Regulations, Section 18983.1(b)(7); and
 - i. Other operations or facilities with processes that process or utilize Organic Waste in a manner that constitutes the reduction of landfill disposal, as determined by CalRecycle in accordance with Title 14, Section 18983.2 of the California Code of Regulations.
2. A Transfer/processing Facility that Recovers Organic Waste for eventual delivery to a facility described in subsection (GG)(1) of County Code, Chapter 20.91-Mandatory Organic Waste Disposal Reduction Ordinance, as long as the Organic Waste has been Source Separated in accordance with Title 14, Sections 18984.1 or 18984.2 of the California Code of Regulations and is not required to be taken to a High Diversion Organic Waste Processing Facility.

Party or Parties means COUNTY and CONTRACTOR, individually and together, respectively.

Performance Obligations means every obligation and liability of CONTRACTOR under this CONTRACT.

Permit means any Federal, State, County, other local, and any other governmental unit Permit, order, license, approval, authorization, consent, or entitlement of whatever kind and however described that Applicable Law requires to be obtained or maintained with respect to the satisfaction of Performance Obligations, as renewed or amended from time to time, including the waste collector Permit issued by the Los Angeles County Department of Public Health.

Person means any individual, firm, association, organization, partnership, corporation, trust, joint venture, State, County, municipality, special purpose district, the United States or any other entity.

Position of Influence means a position of authority or responsibility to directly or indirectly administer, manage, direct, supervise or oversee the Contract Services or this CONTRACT, including the following: (1) serving as director of the board of directors of CONTRACTOR or an Affiliate, (2) serving as an officer of CONTRACTOR or an Affiliate, (3) reviewing or negotiating CONTRACTOR's contracts (including this CONTRACT), (4) providing in-house legal services, and (5) providing insurance or other performance security if the provider is an Affiliate or is a captive of CONTRACTOR or an Affiliate; but excluding the following: (1) monitoring CONTRACTOR's performance, (2) supervising CONTRACTOR's finance and capital budget decisions, and (3) articulating general policies and procedures not related to a Criminal Activity.

Premises means a tract of land located in the Service Area which is safely accessible by Vehicles.

Processing or Process means the controlled separation, recovery, volume reduction, conversion, or Recycling of Solid Waste including, but not limited to, organized, manual, automated, or mechanical sorting, the use of vehicles for spreading of waste for the purpose of recovery, and/or includes the use of conveyor belts, sorting lines, or volume reduction equipment, as defined in 14 CCR Section 17402(a)(20).

Prompt or Promptly means as soon as practicable, but in no event more than two days unless otherwise agreed by Director, Customer, or Occupant.

Property Owner means the owner of real property, as defined in 14 CCR Section 18982(a)(57).

Public Right-of-Way or Right-of-Way includes all the following:

- all land and improvements on that land between the outer edge of a sidewalk (nearest to a private lot) on one side of the street and the outer edge of the sidewalk (nearest to a private lot) on the opposite side of the street, including:
 - sidewalks,
 - and between a sidewalk and street, and
 - median strips in the center of streets.
- Public streets;
- Public alleys, including land wall-to-wall and fence-to-fence, and
- Any other land described by COUNTY to CONTRACTOR.

Quarterly Report is described in item A1 of Section 10.

Rate Adjustments and **Rate Adjustment Example** are both described in Exhibit 7 and Attachment 7-1 Rate Adjustment Example.

RCRA means the Resource Conservation and Recovery Act (42 U.S.C. Section 6901 et seq.).

Reasonable or **Reasonable Business Efforts** means practical actions a sensible person would do in the same (or similar) circumstances using sound judgment and principles of fairness. It will be presumed that the Person intends to meet its obligations in honesty and good faith. It does not mean pursuing every possible action.

Records means documentation relating to Contract Services and other Performance Obligations, including ledgers, books of account, invoices, vouchers, canceled checks, logs, correspondence, computations, files, plans, correspondence, Reports, drawings, designs (other than those respecting facilities or facility operations not involving Collection), data and photographs prepared by or possessed by CONTRACTOR, including the following:

- Customer and Occupant Terms and Conditions and Collection Services information (including Customers and Occupants' names and addresses), billing Records, call logs, route maps, schedules, and correspondence with Customers and Occupants;

- Weight tickets, invoices, bills of lading, and receipts from Solid Waste Facilities for types and amounts of Solid Waste that CONTRACTOR Collects, transports, and delivers to those Solid Waste Facilities;
- Records for AB 939 and other laws, including documentation from Recyclables and Green Waste transporters, shippers, brokers, beneficiaries, remanufacturers, and purchasers or other users of Recyclables and Green Waste; any Reports on Processing of Recyclables or Green Waste residual that Solid Waste Facilities may make to the CalRecycle;
- Vehicle maintenance, driver Permits and driver testing Records;
- Gross revenues and receipts, including Gross Receipts;
- the Franchise Fees paid to COUNTY; and
- Records that may be relevant in the event of an action under CERCLA or similar claims.

Recyclables means Solid Waste that is non-putrescible and that can be Recycled, excluding Unpermitted Waste.

Recyclables includes:

- Bottles, cans, metals, plastics, and glass,
- Paper products,
- Printing and writing paper,

Additional (or deleted) items that Director directs after Notice to CONTRACTOR, without adjustment of Service Rates unless the modification requires Collection Services at the Set-Out Sites separate and distinct from previously Collected Recyclables, subject to item E2 of Exhibit 3A1.

Recyclables are presumed to be Source Separated *unless* they are explicitly described as commingled. Recyclables are synonymous with both of the following:

- "Non-Organic Recyclables" as defined in 14 CCR 18982(a)(43), and 14CCR 17402(a)(26.7),
- Source Separated Recyclables discarded in blue Containers.
- Organic Waste allowed to be Collected in the blue Containers such as: paper, textiles, lumber, carpet and wood.

Recycle or Recycling means the Process of Collecting, sorting, cleansing, treating, and reconstituting materials (including Recyclables and Organic Waste) that would otherwise become Solid Waste and returning them to the economic mainstream in the form of raw material for new, reused, or reconstituted products that meet the quality Standards necessary to be used in the market place. Recycling does not include transformation, as defined in California Public Resources Code Section 40201.

Refuse means Solid Waste that CONTRACTOR does not Divert.

Regulatory Agency means any Federal, State or local governmental agency that regulates Collection and transportation of Solid Waste (including California Department of Transportation, California Department of Motor Vehicles, EDD, U.S. Immigration and Naturalization Services, or other health and safety department thereof; COUNTY; and Local Enforcement Agency applicable to Contract Services).

Report means Quarterly Report, Annual Report and any AB 939, SB1383, or other report CONTRACTOR is required to submit in accordance with this CONTRACT and must be satisfactory to Director.

Residential means Person or thing related to detached, single-family homes or duplexes, other than condominiums or townhouses. Residential also includes multifamily Premises of 4 Units or less.

Residential Premises means Premises containing a Residential building, such as a detached, single-family home or a duplex.

RNG or Renewable Natural Gas means gas derived from Organic Waste that has been diverted from a Landfill and Processed at an in-vessel digestion facility that is permitted or otherwise authorized by 14 CCR to recover Organic Waste, as defined in 14 CCR Section 18982(a)(62).

Roll-offs “roll-off box” means any open-topped rectangular Container for storage, Collection, and transport of Solid Waste that are rolled on and off flatbed Collection Vehicles via winches or reeving cylinders (hooks), sometimes referred to as debris boxes.

Scout Service means using a small truck that can retrieve Containers from hard-to-reach places, such as a narrow street or small enclosures, and are pulled out to an accessible area for the automated Collection Vehicles to service it. Once the Container is emptied by the automated Collection Vehicle, the Container is returned back to its Set-Out Site location.

Self-Haul or Self-Hauler means: (1) for a Person to transport Recyclables, Organic Waste, or Refuse that such Person has generated, or that has been generated on property owned or occupied by such Person, to another location, or to a separate destination owned and operated by such Person, without contracting with or utilizing a third-party; and (2) for a Person to remove Refuse, Organic Waste, or Recyclables generated as a result of gardening, landscaping or contracting services performed by such Person for a third party, when such removal of material is ancillary to the gardening, landscaping or contracting services, without subcontracting for services or equipment.

Senate Bill (SB) 1383 means Senate Bill 1383 of 2016 approved by the Governor on September 19, 2016, which added Sections 39730.5, 39730.6, 39730.7, and 39730.8 to the Health and Safety Code, and added Chapter 13.1 (commencing with Section 42652) to Part 3 of Division 30 of the Public Resources Code, establishing methane emissions reduction targets in a statewide effort to reduce emissions of short-lived climate pollutants as amended, supplemented, superseded, and replaced from time to time.

Senate Bill (SB) 1383 Regulations or SB 1383 Regulatory refers to the Short-Lived Climate Pollutants (SLCP): Organic Waste Reductions regulations developed by CalRecycle and adopted in 2020 that created Chapter 12 of 14 CCR, Division 7 and amended portions of regulations of 14 CCR and 27 CCR.

Service Area means the area mentioned in the title of this CONTRACT, as described in item A1 of Section 16.

Service Assets means all property of CONTRACTOR used directly or indirectly in performing Contract Services, including Vehicles, Containers, maintenance equipment and facilities, and administrative equipment and software, both tangible and intangible (such as facility leases or equipment installment purchase contracts).

Service Day means Collection Services for Commercial Customers is only permitted Monday through Saturday, except following a Holiday. For Residential Customers, Collection Services is permitted any day Monday through Friday, excluding Holidays.

Service Rates means Customer Service Rates as listed in Attachments 7-2 of Exhibit 7

Service Rates Schedule means all the rates listed in Attachments 7-2 of Exhibit 7.

Service Specifications means Performance Obligations prescribed in Exhibit 3A1.

Service Standards means each obligation of CONTRACTOR prescribed in Section 4.

Set-Out Site means the location where the Solid Waste is temporarily placed for Collection as mutually agreed upon by CONTRACTOR and Occupant.

Sharps means any item having corners, edges, or projections capable of cutting or piercing the skin to deliver injections or for medical purposes, such as needles (hypodermic, pen or intravenous), needles with syringes, needles from vacutainers, needles with attached tubing, and lancets.

Sharps Containers means Container approved by COUNTY for discard of Sharps.

Solid Waste means Solid Waste as defined in California Public Resources Code Section 40191, excludes Unpermitted Waste but includes all the following:

- Recyclables,
- Refuse,
- E-waste,
- Organic Waste (including green and food waste),
- Manure

Solid Waste Facility means the facility as defined in California Public Resources Code Section 40194 (and any other types of facilities named by Director) and designated by CONTRACTOR in Contractor Documentation in Exhibit 17.

Source Separated means to separate different types of Solid Waste such as Organic Waste and Recyclables and to place such waste in the correct Container. Source Separation is not required for Customers that utilize a one-Container system in which the combined Solid Waste is transported and delivered to a High Diversion Organic Waste Processing Facility.

Standards means the criterion for excellent Solid Waste management established by the Solid Waste Collection industry; which shall be provided in a thorough and professional manner so that all Customers are provided at all times with reliable, courteous and high-quality Solid Waste handling services. To determine what is "professional" COUNTY may consider policies, standards, recommendations and other statements from associations whose members handle Solid Waste, such as the Solid Waste Association of North American (SWANA), the National Waste and Recycling Association, Association of County Engineers.

Subcontractor means any Person that provides Goods or Services related to Collection, transportation or storage of Solid Waste or related to Service Assets, including their operation, maintenance, and repair, to or on behalf of CONTRACTOR whether pursuant to any arrangement, formal or informal, written or merely in practice. Subcontractor does not include a Person that provides Goods or Services related to Processing, Diversion, or Disposal, nor the manufacturer that provides equipment.

Term means the period beginning on the Execution Date and ending on the Expiration Date and is also defined in item A of Section 2.

Terms and Conditions means the CONTRACT details mailed to Customers and Occupants.

Ton or Tonnage means a short ton of 2,000 pounds avoirdupois.

Transfer is defined in Part 4 of Exhibit 5.

Uncontrollable Circumstances means any of the following events:

- Riots, war, or emergency affecting the County and/or the Country declared by the President of the United States, Congress of the United States, the Governor of California, or the Board of Supervisors;
- Sabotage, civil disturbance, insurrection, explosion;
- Natural disasters such as floods, earthquakes, landslides, and fires;
- Pandemic, epidemics, strikes, lockouts, and other labor disturbances; or
- Other catastrophic events that are beyond the reasonable control of CONTRACTOR despite CONTRACTOR's exercise of due diligence, excluding:
 - The financial inability of CONTRACTOR to satisfy its Performance Obligations, or

- Failure of CONTRACTOR to obtain any necessary Permits or the right to use the facilities of any public entity.

Universal Waste means hazardous waste that the California Department of Toxic Substances Control considers Universal Waste, including materials listed in 22 CCR 66261.9, such as batteries, thermostats, lamps, cathode ray tubes, computers, telephones, answering machines, radios, stereo equipment, tape players/recorders, phonographs, video cassette players/recorders, compact disc players/recorders, calculators, some appliances, aerosol cans and certain mercury-containing devices.

Unpermitted Waste means

- Materials that are not Solid Waste such as Universal Waste, household hazardous waste and other hazardous waste, unauthorized medical waste, radioactive waste;
- Waste tires more than the limitations prescribed in 14 CCR 17355(b) or reduced in volume as required in 14 CCR 17355(A);
- Any other materials that cannot be Disposed of in class II sanitary landfills described in 27 CCR 20250.

Unpermitted Waste Screening Protocol means the protocol prescribed in Item A of Section 13 and included in Contractor Documentation in Exhibit 17.

Vehicle means any truck used by CONTRACTOR to provide Contract Services.

Violation of Applicable Law means any noncompliance with Applicable Law as evidenced by Notice, assessment, or determination of any Regulatory Agency to CONTRACTOR, whether a fine or penalty is included, assessed, levied, or attached.

Weighted Customer Service Rate Adjustment Percentage means sum of the adjustments due to changes in the CPI, for Trash and Garbage Collection (CUUR0000SEHG02), U.S. City average, as published by the United States Department of Labor, Bureau of Labor Statistics at <https://beta.bls.gov/dataViewer/view/timeseries/CUUR0000SEHG02>.

EXHIBIT 7 – Rate Adjustments

A. Service Rates Schedule

CONTRACTOR shall charge Service Rates (Customer Service Rates) in amounts less than or equal to the Service Rates set forth in the Service Rates Schedule in Attachment 7-2 of this Exhibit.

1. Time, Conditions, Changes

a. *Annual Adjustments*

(1) Annual CPI Calculation:

Beginning at least 6 months after the Commencement Date, Director will adjust the Service Rates each July 1 based on the percentage change in the average annual published CPI, for Trash and Garbage Collection (CUUR0000SEHG02), U.S. City average, as published by the United States Department of Labor, Bureau of Labor Statistics. The annual change is a comparison of the average monthly rate for the two previous Calendar Years.

A minimum of 6 months must elapse between Commencement Date and July 1 of the current year. The CPI component of the Service Rate will be the percent change, if any, between the following:

- The monthly average CPI during the 12-month period commencing March 1 of the previous year to the last day of February of the current year, and
- The monthly average CPI during the 12-month period commencing March 1 of the prior previous year to the last day of February of the previous year.

For example, a contract that started April 1, 2021, will not be eligible for a Rate Adjustment for CPI on July 1, 2021. On July 1, 2022, the Rate Adjustment would compare March 1, 2021 through February 28, 2022, to March 1, 2020 through February 28, 2021.

The index to be used is the Consumer Price Index for Trash and Garbage Collection (CUUR0000SEHG02), U.S. City average, as published by the United States Department of Labor, Bureau of Labor Statistics at <https://beta.bls.gov/dataViewer/view/timeseries/CUUR0000SEHG02>.

b. Adjustments at Any Time

If CONTRACTOR requests Director by Notice or Director Notifies CONTRACTOR at any time, following agreement with CONTRACTOR, the Director may adjust the Service Rates in either of the following events, subject to changes in Refuse Disposal or Organic Waste Diversion in subsection A3, and limitations in A5:

(1) Changes in Law

Change in CONTRACTOR's Direct Costs of providing Contract Services due to Changes in Law. Any adjustment in the Service Rate due to a Change in Law by the State is not included in the Maximum Rate Adjustment in subsection 3.

(2) Changes in Scope of Service

CONTRACTOR's Direct Costs of providing Contract Services due to changes in Contract Services or Standards.

(3) Extraordinary Circumstances

Change in CONTRACTOR's Direct Costs of providing Contract Services due to unforeseeable events.

c. No Adjustment

Service Rates will not be adjusted:

- During any of the six possible one-month extensions under item A3 of Section 2.
- If there are any uncured Breaches.
- For any slight increase or decrease in Customers due to inaccuracies in Customer data and Service Area boundaries.

2. Rounding

All calculations are rounded to the nearest 1/100th decimal place (for example, 10.9656 percent to 10.97 percent, or 10.9637 percent to 10.96). The decimal 5 is rounded up (for example, 10.965 percent to 10.97 percent). Adjustments in Service Rates are rounded to the nearest penny (for example, \$25.34).

3. Maximum Rate Adjustment

Adjustments to the Service Rates cannot exceed the percentages in the following table, except for changes due to acts of the State in item A1b(1) of this exhibit:

Contract Period (on July 1)*	Maximum Adjustment**
Years 0 to 0.5 (Less than 6 months from Commencement Date to July 1)	0 percent
Years 0.5 to 10 (July 1 to the scheduled Termination Date under Section 2)	5 percent
3-Year / Extension #1, if any (July 1 of any first 3-year extension to June 30 on the extended Termination Date)	5 percent
3-Year / Extension #2, if any (July 1 of any 3-year extension to June 30 further extended Termination Date)	5 percent
3-Year / Extension #3, if any (July 1 of any 3-year extension to June 30 further extended Termination Date)	5 percent
Six 1-month extensions, if any	No Change
Any time (Changes in direct costs due to Change in Law by the State)	Actual Direct Costs

- * Rate Adjustments due to Changes in Laws or Contract Services under subsection A1 above may be implemented at any time during the Term.
- ** Any change in Service Rates for direct costs due to Changes in Law promulgated by the State in item A1b(1) of this exhibit are not included in the percentage calculations of the Maximum Cumulative Service Rate Adjustment. They are added to the percentage calculations.

For example, during the first ten years of the CONTRACT, the Service Rate could increase 35 percent plus an additional amount due to an increase of \$4 per Ton on the State-mandated Disposal fee.

4. Customer 30-Day Notice

CONTRACTOR shall provide all Customers a minimum of 30-days written Notice of the implementation of changes in any Customer Service Rates.

5. Adjustment Limitations

No adjustment will be effective until Notice thereof has been provided by COUNTY to the Board of Supervisors.

Service Rates will be adjusted only if there are no uncured Breaches.

If CONTRACTOR and Director fail to reach an agreement to adjust the Service Rates because of Changes in Law or changes in Contract Services or Standards described below, COUNTY will have the option to not adjust the rate for changes in law, changes in scope of service, or extraordinary circumstances for the upcoming Fiscal Year.

6. Services Eligible for Adjustment

a. Customer Service Rates (CPI)

b. Customer Extra Services Fees (CPI)

B. Discontinued Indices

If a price or index is discontinued on the date of adjustment, the last available price or index for the required period (such as Calendar Year or another 12-month period) will be used, or other index as determined by Director.

ATTACHMENT 7-1 – Rate Adjustment Example

Example assumes the following:

- Contract started 4/1/21
 - First Calendar Year of service is only 9 months
 - Rate adjustment was not eligible 7/1/21
- Rate adjustment being calculated is for 7/1/22

A. Annual increase or decrease in CPI

Step 1: Calculate percentage change in indices.

Table A—Adjustment Due to Change in CPI		
Calculate percent change in CPI, Garbage and Trash Collection (1) (12-month average)	03/01/19-02/29/20 (A)	484.59
	03/01/20-02/28/21 (B)	502.41
	Percent change (C)	3.68%

Step 2: Apply percentage change to rates.

Example Categories	Rate	(D) Example Customer Rate (2)	(E) Percentage Change in Index (from Row C above)	(F) Rate Increase or Decrease (Column D x Column E)	(G) Adjusted Rate (Column D + Column F)
Commercial- Refuse 3 CY 1x week		\$90.00	3.68%	\$3.31	\$93.31
Commercial- Organic Waste - 64-Gallon 2x week		\$81.03	3.68%	\$2.98	\$84.01
Pad Lock		\$15.00	3.68%	\$0.55	\$15.55
Multifamily- 1 Container for Trash & Organics 3 CY 1 x week		\$105.00	3.68%	\$3.86	\$108.86

(1) Consumer Price Index Consumer Price Index (CUUR0000SEHG02) for All Urban Consumers, garbage and trash collection – U.S. city average, not seasonally adjusted, as published by the United States Department of Labor, Bureau of Labor Statistics. The CPI component of the Service Rates will be the percent change, if any, between the following:

- The monthly average CPI during the 12-month period commencing March 1 of the previous year to the last day of February of the current year, and
- The monthly average CPI during the 12-month period commencing March 1 of the prior previous year to the last day of February of the previous year.

(2) Example rates listed. Adjustment applies to all rates.

ATTACHMENT 7-2- SERVICE RATES

- A. Table 1- Commercial Rates**
- B. Table 2- Multifamily Rates**
- C. Table 3- Residential Rates**
- D. Table 4- Single Pass Collection**
- E. Table 5- Extra Services Fees to Customer**
- F. Table 6- Other Additional Services Rates**

The undersigned Proposer offers to perform the work described in the Request for Proposals (RFP) for the following price(s). The Proposer rate(s) (hourly, monthly, etc.) shall include all administrative costs, franchise fees, labor, supervision, overtime, materials, transportation, taxes, equipment, and supplies unless stated otherwise in the RFP. The Proposer understands and agrees that the quantities set forth in the Schedule of Prices by the County are only estimates are based on current hauler submittals. Any unit prices quoted by the Proposer in this Schedule of Prices will apply to the actual quantities of work. The Proposer may use the estimates to develop its cost and rate proposal. The Proposer understands and agrees that each of the Service Areas have different Customer counts. County makes no representation or warranties of any kind, expressed or implied, as to the accuracy of the information set forth in the Schedule of Prices. County will not be liable for any damages or loss of any nature, including, but not limited to, lost profits, resulting from the estimates provided by the County. Proposer agrees to indemnify and hold the County harmless with respect to any issues, disputes, claims, lawsuits resulting from the estimates provided by the County in this solicitation, and in particular, as set forth in the Schedule of Prices. It is the responsibility of the proposer to undertake, at its sole cost, any verification of any and all information necessary for the preparation and submittal of a response to this RFP.

It is the County's sole discretion to select the collection method for each Service Area after receipt of all proposals. The County's selected collection method may not be the lowest cost collection method. The County may consider factors including but not limited to, cost per cubic yard, readiness to implement, regulatory compliance, and waste diversion potential, when deciding upon a collection method for each Service Area.

Instructions: Proposer shall enter proposed monthly rates in the blue boxes below and the discounted rate for Customers who have a waiver/exemption for Organic Waste Collection Services in the yellow box below. Proposer must submit a proposal/bid for each collection method: Three-Container, Two-Container and One-Container collection methods. Failure to do so may result in the proposal/bid being rejected as nonresponsive. All proposers should include the 14% franchise fee in their proposed rates. Proposers shall not change the numbers in Column D- Estimated No. of Collections per Week. Column E will autocalculate the Proposed Annual Amount for each service. The Proposed Total Annual Amounts for Collection Services of the County selected collection method will be used for the evaluation evaluated. Proposer is responsible for ensuring accuracy of calculations.

Commercial Collection Services (Three-Container)

Note: The following rates apply to Commercial Customers. The Minimum Default Collection Service rate includes a minimum base rate for Refuse, Organic Waste, and Recyclables Collection Services. The minimum base rate for Refuse includes the equivalent of 64 gallons of weekly Organic Waste and 96 gallons of weekly Recycling Collection Service per Customer, both at no additional charge. Recycling rates shall be no more than half of the Refuse rates and Organic Waste rates shall be no greater than the Refuse rates.

Disposal Facility Name: GRAND CENTRAL RECYCLING AND TRANSFER Rate (Per Ton): \$77.84
Backup Disposal Facility Name: LACSD Rate (Per Ton): \$77.84

Service Description	Collection Frequency (No. of Pickups per Week)	Monthly Unit Price/Rate	(Discount Rate 3%)	Monthly Unit Price/Rate (Final Discounted Rate)	*Estimated No. of Collections per Week	Annual Amount (Discounted Monthly Unit Price/Rate x Estimated No. of Collections per Week x 12)
32-Gallon Cart	1	\$31.58	3.00%	\$30.63	1	\$367.59
	2	\$52.34	3.00%	\$50.77	1	\$609.24
	3	\$70.85	3.00%	\$68.72	1	\$824.69
	4	\$88.71	3.00%	\$86.05		\$0.00
	5	\$106.58	3.00%	\$103.38		\$0.00
	6	\$122.73	3.00%	\$119.05		\$0.00
	7	\$138.88	3.00%	\$134.71		\$0.00
64-Gallon Cart	1	\$35.79	3.00%	\$34.72	37	\$15,414.04
	2	\$59.32	3.00%	\$57.54		\$0.00
	3	\$80.29	3.00%	\$77.88		\$0.00
	4	\$100.54	3.00%	\$97.52		\$0.00
	5	\$120.79	3.00%	\$117.17		\$0.00
	6	\$139.09	3.00%	\$134.92		\$0.00
	7	\$157.39	3.00%	\$152.67		\$0.00
96-Gallon Cart	1	\$42.11	3.00%	\$40.85	119	\$58,329.09
	2	\$69.79	3.00%	\$67.70	6	\$4,874.13
	3	\$94.46	3.00%	\$91.63	1	\$1,099.51
	4	\$118.28	3.00%	\$114.73		\$0.00
	5	\$142.11	3.00%	\$137.85		\$0.00
	6	\$163.64	3.00%	\$158.73		\$0.00
	7	\$185.17	3.00%	\$179.61		\$0.00
1 CY Dumpster	1	\$103.11	3.00%	\$100.02	318	\$381,663.73
	2	\$206.21	3.00%	\$200.02	162	\$388,846.07
	3	\$309.32	3.00%	\$300.04	108	\$388,852.38
	4	\$343.97	3.00%	\$333.65	9	\$36,034.30
	5	\$375.18	3.00%	\$363.92	30	\$131,012.88
	6	\$422.32	3.00%	\$409.65	17	\$83,568.68
	7	\$469.46	3.00%	\$455.38		\$0.00
1.5 CY Dumpster	1	\$111.87	3.00%	\$108.51	19	\$24,741.17
	2	\$223.74	3.00%	\$217.03	12	\$31,252.00
	3	\$335.61	3.00%	\$325.54	21	\$82,036.51
	4	\$379.02	3.00%	\$367.65	3	\$13,235.38
	5	\$419.00	3.00%	\$406.43	4	\$19,508.64
	6	\$474.90	3.00%	\$460.65	2	\$11,055.67
	7	\$530.80	3.00%	\$514.88		\$0.00
2 CY Dumpster	1	\$120.63	3.00%	\$117.01	3	\$4,212.40
	2	\$241.27	3.00%	\$234.03	1	\$2,808.38
	3	\$361.90	3.00%	\$351.04	3	\$12,637.58
	4	\$414.07	3.00%	\$401.65	1	\$4,819.77
	5	\$462.81	3.00%	\$448.93		\$0.00
	6	\$527.48	3.00%	\$511.66		\$0.00
	7	\$592.15	3.00%	\$574.39		\$0.00

3 CY Dumpster	1	\$138.16	3.00%	\$134.02		\$0.00
	2	\$276.32	3.00%	\$268.03		\$0.00
	3	\$414.48	3.00%	\$402.05		\$0.00
	4	\$484.18	3.00%	\$469.65		\$0.00
	5	\$550.45	3.00%	\$533.94		\$0.00
	6	\$632.64	3.00%	\$613.66		\$0.00
	7	\$714.83	3.00%	\$693.39		\$0.00
4 CY Dumpster	1	\$155.69	3.00%	\$151.02		\$0.00
	2	\$311.37	3.00%	\$302.03		\$0.00
	3	\$467.06	3.00%	\$453.05		\$0.00
	4	\$554.28	3.00%	\$537.65		\$0.00
	5	\$638.08	3.00%	\$618.94		\$0.00
	6	\$737.79	3.00%	\$715.66		\$0.00
	7	\$837.50	3.00%	\$812.38		\$0.00
6 CY Dumpster	1	\$190.74	3.00%	\$185.02		\$0.00
	2	\$381.48	3.00%	\$370.04		\$0.00
	3	\$572.22	3.00%	\$555.05		\$0.00
	4	\$694.49	3.00%	\$673.66		\$0.00
	5	\$813.34	3.00%	\$788.94		\$0.00
	6	\$948.11	3.00%	\$919.67		\$0.00
	7	\$1,082.88	3.00%	\$1,050.39		\$0.00
8 CY to 40 CY Roll-offs	1	\$220.00	3.00%	\$213.40	72	\$184,377.60
	2	\$440.00	3.00%	\$426.80	1	\$5,121.60
	3	\$880.00	3.00%	\$853.60		\$0.00
	4	\$1,760.00	3.00%	\$1,707.20		\$0.00
	5	\$3,520.00	3.00%	\$3,414.40		\$0.00
	6	\$7,040.00	3.00%	\$6,828.80		\$0.00
	7	\$14,080.00	3.00%	\$13,657.60		\$0.00
Compactor	1	\$250.00	3.00%	\$242.50		\$0.00
	2	\$500.00	3.00%	\$485.00		\$0.00
	3	\$1,000.00	3.00%	\$970.00		\$0.00
	4	\$2,000.00	3.00%	\$1,940.00		\$0.00
	5	\$4,000.00	3.00%	\$3,880.00		\$0.00
	6	\$8,000.00	3.00%	\$7,760.00		\$0.00
	7	\$16,000.00	3.00%	\$15,520.00		\$0.00
Total Proposed Annual Amount (1A)						\$1,887,302.97

Permanent Roll-Offs and Compactors: All 8, 10, 20, 30, 40 CY Roll-offs and compactors are pull rates only; total cost will be based on actual Disposal and/or Processing costs. Rates charged to Customers should include the total cost for pull, Processing and Disposal rates.

Temporary Roll-offs (Non-permanent service of no more than 30 consecutive days at Customer's site): Shall be charged as accordingly to the Service Rates indicated above and may charge an additional daily rental fee (See Extra Services Fees).

Discounted Rates for Customers with Waivers and Exemptions

Proposer must provide discounted rates for Customers that have been issued waivers and exemptions for part or all of Collection Services. Proposer must insert the discounted rate in the yellow box below for Customers that have been issued a waiver/exemption for Organic Waste Collection Services.

Customer Scenarios	Monthly Rate
1) Customer that Self-Hauls Refuse, Recyclables and Organic Waste.	\$__0__ for Solid Waste Collection Services
2) Customer that Self-Hauls Refuse only (Customer still needs to subscribe to Organic Waste and Recyclables Collection).	\$__0__ for Refuse
3) Customer that Self-Hauls Organic Waste and has an Organic Waste waiver/exemption (Customer still needs to subscribe to Refuse and Recyclables Collection).	The Monthly Rate to Customer should be \$__0__ for Organic Waste. For Refuse, all monthly rates should be discounted by \$13 of the Solid Waste Collection Service Rates.

*Estimated No. of Collections per Week is based on 2019 Customer data submitted by the current non-exclusive commercial franchise waste haulers. Each of the Service Areas have different Customer counts.

Additional Entry: (Proposer may use this space to add additional information such as additional facilities and if Proposer would like to add any additional service levels and Container sizes that may have not been identified above)

TEMP ROLLOFF \$538.00 PER TON \$77.84

The undersigned Proposer offers to perform the work described in the Request for Proposals (RFP) for the following price(s). The Proposer rate(s) (hourly, monthly, etc.) shall include all administrative costs, franchise fees, labor, supervision, overtime, materials, transportation, taxes, equipment, and supplies unless stated otherwise in the RFP. The Proposer understands and agrees that the quantities set forth in the Schedule of Prices by the County are only estimates and are based on current hauler submittals. Any unit prices quoted by the Proposer in this Schedule of Prices will apply to the actual quantities of work. The Proposer may use the estimates to develop its cost and rate proposal. The Proposer understands and agrees that each of the Service Areas have different Customer counts. County makes no representation or warranties of any kind, expressed or implied, as to the accuracy of the information set forth in the Schedule of Prices. County will not be liable for any damages or loss of any nature, including, but not limited to, lost profits, resulting from the estimates provided by the County. Proposer agrees to indemnify and hold the County harmless with respect to any issues, disputes, claims, lawsuits resulting from the estimates provided by the County in this solicitation, and in particular, as set forth in the Schedule of Prices. It is the responsibility of the proposer to undertake, at its sole cost, any verification of any and all information necessary for the preparation and submittal of a response to this RFP.

It is the County's sole discretion to select the collection method for each Service Area after receipt of all proposals. The County's selected collection method may not be the lowest cost collection method. The County may consider factors including but not limited to, cost per cubic yard, readiness to implement, regulatory compliance, and waste diversion potential, when deciding upon a collection method for each Service Area.

Instructions: Proposer shall enter proposed monthly rates in the blue boxes below. Proposer must submit a proposal/bid for each collection method: Three-Container, Two-Container and One-Container collection methods. Failure to do so may result in the proposal/bid being rejected as nonresponsive. All proposers should include the 14% franchise fee in their proposed rates. Proposers shall not change the numbers in Column D- Estimated No. of Collections per Week. Column E will autocalculate the Proposed Annual Amount for each service. The Proposed Total Annual Amounts for Collection Services of the County selected collection method will be used for the evaluation evaluated. Proposer is responsible for ensuring accuracy of calculations.

Additional Containers for Recyclables

Note: The following rates apply to Commercial Customers. These are the rates that are requested in addition to the Minimum Default Collection Service. Recycling rates should be no more than half of the Refuse rates. The Minimum Default Collection Service includes the equivalent of 96 gallons of weekly Recycling Collection Service per Customer at no additional charge.

Disposal Facility Name: GRAND CENTRAL RECYCLING AND TRANSFER Rate (Per Ton): \$77.84

Backup Disposal Facility Name: LACSD Rate (Per Ton): \$77.84

Service Description	Collection Frequency (No. of Pickups per Week)	Monthly Unit Price/Rate	(Discount Rate 3%)	Monthly Unit Price/Rate (Final Discounted Rate)	*Estimated No. of Collections per Week	Annual Amount (Discounted Monthly Unit Price/Rate x Estimated No. of Collections per Week x 12)
32-Gallon Cart	1	\$15.79	3.00%	\$15.32		\$0.00
	2	\$26.17	3.00%	\$25.38		\$0.00
	3	\$35.43	3.00%	\$34.36		\$0.00
	4	\$44.36	3.00%	\$43.02		\$0.00
	5	\$53.29	3.00%	\$51.69		\$0.00
	6	\$61.37	3.00%	\$59.52		\$0.00
	7	\$69.44	3.00%	\$67.36		\$0.00
64-Gallon Cart	1	\$17.90	3.00%	\$17.36	1	\$208.30
	2	\$29.68	3.00%	\$28.77		\$0.00
	3	\$40.15	3.00%	\$38.94		\$0.00
	4	\$50.27	3.00%	\$48.76		\$0.00
	5	\$60.40	3.00%	\$58.58		\$0.00
	6	\$69.55	3.00%	\$67.46		\$0.00
	7	\$78.70	3.00%	\$76.33		\$0.00
96-Gallon Cart	1	\$21.06	3.00%	\$20.42	11	\$2,695.88
	2	\$34.90	3.00%	\$33.85		\$0.00
	3	\$47.23	3.00%	\$45.81		\$0.00
	4	\$59.14	3.00%	\$57.37		\$0.00
	5	\$71.06	3.00%	\$68.92		\$0.00
	6	\$81.82	3.00%	\$79.37		\$0.00
	7	\$92.59	3.00%	\$89.81		\$0.00
1 CY Dumpster	1	\$51.56	3.00%	\$50.01	148	\$88,814.83
	2	\$103.11	3.00%	\$100.01	7	\$8,401.00
	3	\$154.66	3.00%	\$150.02	1	\$1,800.24
	4	\$171.99	3.00%	\$166.83		\$0.00
	5	\$187.59	3.00%	\$181.96		\$0.00
	6	\$211.16	3.00%	\$204.83		\$0.00
	7	\$234.73	3.00%	\$227.69		\$0.00
1.5 CY Dumpster	1	\$55.94	3.00%	\$54.26	296	\$192,720.68
	2	\$111.87	3.00%	\$108.51	152	\$197,929.35
	3	\$167.81	3.00%	\$162.77	107	\$208,997.77
	4	\$189.51	3.00%	\$183.82	11	\$24,264.86
	5	\$209.50	3.00%	\$203.22	30	\$73,157.40
	6	\$237.45	3.00%	\$230.33	15	\$41,458.77
	7	\$265.40	3.00%	\$257.44		\$0.00
2 CY Dumpster	1	\$60.32	3.00%	\$58.51	32	\$22,466.13
	2	\$120.64	3.00%	\$117.02	21	\$29,488.02
	3	\$180.96	3.00%	\$175.52	21	\$44,231.42
	4	\$207.04	3.00%	\$200.82	2	\$4,819.77
	5	\$231.41	3.00%	\$224.46		\$0.00
	6	\$263.74	3.00%	\$255.83	3	\$9,209.80
	7	\$296.08	3.00%	\$287.19		\$0.00
3 CY Dumpster	1	\$69.08	3.00%	\$67.01	9	\$7,236.82
	2	\$138.16	3.00%	\$134.02	1	\$1,608.18
	3	\$207.24	3.00%	\$201.02	4	\$9,649.05
	4	\$242.09	3.00%	\$234.83		\$0.00
	5	\$275.23	3.00%	\$266.97	4	\$12,814.48
	6	\$316.32	3.00%	\$306.83	1	\$3,681.96
	7	\$357.42	3.00%	\$346.69		\$0.00

4 CY Dumpster	1	\$77.89	3.00%	\$75.51		\$0.00
	2	\$155.69	3.00%	\$151.01		\$0.00
	3	\$233.53	3.00%	\$226.52		\$0.00
	4	\$277.14	3.00%	\$268.83		\$0.00
	5	\$319.04	3.00%	\$309.47		\$0.00
	6	\$368.90	3.00%	\$357.83		\$0.00
	7	\$418.75	3.00%	\$406.19		\$0.00
6 CY Dumpster	1	\$95.37	3.00%	\$92.51		\$0.00
	2	\$190.74	3.00%	\$185.02		\$0.00
	3	\$286.11	3.00%	\$277.53		\$0.00
	4	\$347.25	3.00%	\$336.83		\$0.00
	5	\$406.67	3.00%	\$394.47		\$0.00
	6	\$474.06	3.00%	\$459.83		\$0.00
	7	\$541.44	3.00%	\$525.20		\$0.00
8 CY to 40 CY Roll-offs	1	\$220.00	3.00%	\$213.40	72	\$184,377.60
	2	\$440.00	3.00%	\$426.80	1	\$5,121.60
	3	\$880.00	3.00%	\$853.60		\$0.00
	4	\$1,760.00	3.00%	\$1,707.20		\$0.00
	5	\$3,520.00	3.00%	\$3,414.40		\$0.00
	6	\$7,040.00	3.00%	\$6,828.80		\$0.00
	7	\$14,080.00	3.00%	\$13,657.60		\$0.00
Compactor	1	\$250.00	3.00%	\$242.50		\$0.00
	2	\$500.00	3.00%	\$485.00		\$0.00
	3	\$1,000.00	3.00%	\$970.00		\$0.00
	4	\$2,000.00	3.00%	\$1,940.00		\$0.00
	5	\$4,000.00	3.00%	\$3,880.00		\$0.00
	6	\$8,000.00	3.00%	\$7,760.00		\$0.00
	7	\$16,000.00	3.00%	\$15,520.00		\$0.00
Total Proposed Annual Amount for (1B)						\$1,175,153.97
Permanent Roll-Offs and Compactors: All 8, 10, 20, 30, 40 CY Roll-offs and compactors are pull rates only; total cost will be based on actual Disposal and/or Processing costs. Rates charged to Customers should include the total cost for pull, Processing and Disposal rates.						
Temporary Roll-offs (Non-permanent service of no more than 30 consecutive days at Customer's site): Shall be charged as accordingly to the Service Rates indicated above and may charge an additional daily rental fee (See Extra Services Fees).						
*Estimated No. of Collections per Week is based on 2019 Customer data submitted by the current non-exclusive commercial franchise waste haulers. Each of the Service Areas have different Customer counts.						
Additional Entry: (Proposer may use this space to add additional information such as additional facilities and if Proposer would like to add any additional service levels and Container sizes that may have not been identified above) TEMP ROLLOFF \$538.00 PER TON \$77.84						

The undersigned Proposer offers to perform the work described in the Request for Proposals (RFP) for the following price(s). The Proposer rate(s) (hourly, monthly, etc.) shall include all administrative costs, franchise fees, labor, supervision, overtime, materials, transportation, taxes, equipment, and supplies unless stated otherwise in the RFP. The Proposer understands and agrees that the quantities set forth in the Schedule of Prices by the County are only estimates are based on current hauler submittals. Any unit prices quoted by the Proposer in this Schedule of Prices will apply to the actual quantities of work. The Proposer may use the estimates to develop its cost and rate proposal. The Proposer understands and agrees that each of the Service Areas have different Customer counts. County makes no representation or warranties of any kind, expressed or implied, as to the accuracy of the information set forth in the Schedule of Prices. County will not be liable for any damages or loss of any nature, including, but not limited to, lost profits, resulting from the estimates provided by the County. Proposer agrees to indemnify and hold the County harmless with respect to any issues, disputes, claims, lawsuits resulting from the estimates provided by the County in this solicitation, and in particular, as set forth in the Schedule of Prices. It is the responsibility of the proposer to undertake, at its sole cost, any verification of any and all information necessary for the preparation and submittal of a response to this RFP.

It is the County's sole discretion to select the collection method for each Service Area after receipt of all proposals. The County's selected collection method may not be the lowest cost collection method. The County may consider factors including but not limited to, cost per cubic yard, readiness to implement, regulatory compliance, and waste diversion potential, when deciding upon a collection method for each Service Area.

Instructions: Proposer shall enter proposed monthly rates in the blue boxes below. Proposer must submit a proposal/bid for each collection method: Three-Container, Two-Container and One-Container collection methods. Failure to do so may result in the proposal/bid being rejected as nonresponsive. All proposers should include the 14% franchise fee in their proposed rates. Proposers shall not change the numbers in Column D- Estimated No. of Collections per Week. Column E will autocalculate the Proposed Annual Amount for each service. The Proposed Total Annual Amounts for Collection Services of the County selected collection method will be used for the evaluation evaluated. Proposer is responsible for ensuring accuracy of calculations.

Additional Containers for Organic Waste

Note: The following rates apply to Commercial Customers. These are the rates that are requested in addition to the Minimum Default Collection Service. Organic Waste rates shall be no greater than the Refuse rates. The Minimum Default Collection Service includes the equivalent of 64 gallons of weekly Organic Waste Collection Service per Customer at no additional charge.

Disposal Facility Name: GRAND CENTRAL RECYCLING AND TRANSFER Rate (Per Ton): \$105.00
Backup Disposal Facility Name: LACSD Rate (Per Ton): \$112.07

Service Description	Collection Frequency (No. of Pickups per Week)	Monthly Unit Price/Rate	(Discount Rate 3%)	Monthly Unit Price/Rate (Final Discounted Rate)	*Estimated No. of Collections per Week	Annual Amount (Discounted Monthly Unit Price/Rate x Estimated No. of Collections per Week x 12)
32-Gallon Cart	1	\$31.58	3.00%	\$30.63	1	\$367.59
	2	\$52.34	3.00%	\$50.77	1	\$609.24
	3	\$70.85	3.00%	\$68.72	1	\$824.69
	4	\$88.71	3.00%	\$86.05		\$0.00
	5	\$106.58	3.00%	\$103.38		\$0.00
	6	\$122.73	3.00%	\$119.05		\$0.00
	7	\$138.88	3.00%	\$134.71		\$0.00
64-Gallon Cart	1	\$35.79	3.00%	\$34.72	37	\$15,414.04
	2	\$59.32	3.00%	\$57.54		\$0.00
	3	\$80.29	3.00%	\$77.88		\$0.00
	4	\$100.54	3.00%	\$97.52		\$0.00
	5	\$120.79	3.00%	\$117.17		\$0.00
	6	\$139.09	3.00%	\$134.92		\$0.00
	7	\$157.39	3.00%	\$152.67		\$0.00
96-Gallon Cart	1	\$42.11	3.00%	\$40.85	119	\$58,329.09
	2	\$69.79	3.00%	\$67.70	6	\$4,874.13
	3	\$94.46	3.00%	\$91.63	1	\$1,099.51
	4	\$118.28	3.00%	\$114.73		\$0.00
	5	\$142.11	3.00%	\$137.85		\$0.00
	6	\$163.64	3.00%	\$158.73		\$0.00
	7	\$185.17	3.00%	\$179.61		\$0.00
1 CY Dumpster	1	\$83.04	3.00%	\$80.55	319	\$308,340.81
	2	\$142.40	3.00%	\$138.13	162	\$268,520.83
	3	\$196.86	3.00%	\$190.95	110	\$252,059.54
	4	\$249.92	3.00%	\$242.42	9	\$26,181.62
	5	\$302.99	3.00%	\$293.90	30	\$105,804.11
	6	\$352.29	3.00%	\$341.72	17	\$69,711.15
	7	\$401.59	3.00%	\$389.54		\$0.00
1.5 CY Dumpster	1	\$96.69	3.00%	\$93.79	15	\$16,882.07
	2	\$169.70	3.00%	\$164.61	4	\$7,901.23
	3	\$237.81	3.00%	\$230.68	12	\$33,217.30
	4	\$304.52	3.00%	\$295.38		\$0.00
	5	\$371.24	3.00%	\$360.10	4	\$17,284.93
	6	\$434.19	3.00%	\$421.16	1	\$5,053.97
	7	\$497.14	3.00%	\$482.23		\$0.00

2 CY Dumpster	1	\$120.63	3.00%	\$117.01	5	\$7,020.67
	2	\$241.27	3.00%	\$234.03	9	\$25,275.45
	3	\$361.90	3.00%	\$351.04	9	\$37,912.64
	4	\$414.07	3.00%	\$401.65	3	\$14,459.32
	5	\$462.81	3.00%	\$448.93		\$0.00
	6	\$527.48	3.00%	\$511.66	1	\$6,139.87
	7	\$592.15	3.00%	\$574.35		\$0.00
3 CY Dumpster	1	\$138.16	3.00%	\$134.02	1	\$1,608.18
	2	\$276.32	3.00%	\$268.03		\$0.00
	3	\$414.48	3.00%	\$402.05	1	\$4,824.55
	4	\$484.18	3.00%	\$469.65	1	\$5,635.86
	5	\$550.45	3.00%	\$533.94		\$0.00
	6	\$632.64	3.00%	\$613.66		\$0.00
	7	\$714.83	3.00%	\$693.39		\$0.00
8 CY to 40 CY Roll-offs	1	\$155.69	3.00%	\$151.02	72	\$130,480.68
	2	\$311.37	3.00%	\$302.03	1	\$3,624.35
	3	\$467.06	3.00%	\$453.05		\$0.00
	4	\$554.28	3.00%	\$537.65		\$0.00
	5	\$638.08	3.00%	\$618.94		\$0.00
	6	\$737.79	3.00%	\$715.66		\$0.00
	7	\$837.50	3.00%	\$812.38		\$0.00
Compactor	1	\$190.74	3.00%	\$185.02		\$0.00
	2	\$381.48	3.00%	\$370.04		\$0.00
	3	\$572.22	3.00%	\$555.05		\$0.00
	4	\$694.49	3.00%	\$673.66		\$0.00
	5	\$813.34	3.00%	\$788.94		\$0.00
	6	\$948.11	3.00%	\$919.67		\$0.00
	7	\$1,082.88	3.00%	\$1,050.39		\$0.00
Total Proposed Annual Amount for (1C)						\$1,429,457.42
<p>Permanent Roll-Offs and Compactors: All 8, 10, 20, 30, 40 CY Roll-offs and compactors are pull rates only; total cost will be based on actual Disposal and/or Processing costs. Rates charged to Customers should include the total cost for pull, Processing and Disposal rates.</p> <p>Temporary Roll-offs (Non-permanent service of no more than 30 consecutive days at Customer's site): Shall be charged as accordingly to the Service Rates indicated above and may charge an additional daily rental fee (See Extra Services Fees).</p>						
<p>*Estimated No. of Collections per Week is based on 2019 Customer data submitted by the current non-exclusive commercial franchise waste haulers. Each of the Service Areas have different Customer counts.</p>						
<p>Additional Entry: (Proposer may use this space to add additional information such as additional facilities and if Proposer would like to add any additional service levels and Container sizes that may have not been identified above)</p> <p style="text-align: right;">TEMP ROLLOFF \$538.00 PER TON \$77.84</p>						

The undersigned Proposer offers to perform the work described in the Request for Proposals (RFP) for the following price(s). The Proposer rate(s) (hourly, monthly, etc.) shall include all administrative costs, franchise fees, labor, supervision, overtime, materials, transportation, taxes, equipment, and supplies unless stated otherwise in the RFP. The Proposer understands and agrees that the quantities set forth in the Schedule of Prices by the County are only estimates are based on current hauler submittals. Any unit prices quoted by the Proposer in this Schedule of Prices will apply to the actual quantities of work. The Proposer may use the estimates to develop its cost and rate proposal. The Proposer understands and agrees that each of the Service Areas have different Customer counts. County makes no representation or warranties of any kind, expressed or implied, as to the accuracy of the information set forth in the Schedule of Prices. County will not be liable for any damages or loss of any nature, including, but not limited to, lost profits, resulting from the estimates provided by the County. Proposer agrees to indemnify and hold the County harmless with respect to any issues, disputes, claims, lawsuits resulting from the estimates provided by the County in this solicitation, and in particular, as set forth in the Schedule of Prices. It is the responsibility of the proposer to undertake, at its sole cost, any verification of any and all information necessary for the preparation and submittal of a response to this RFP.

It is the County's sole discretion to select the collection method for each Service Area after receipt of all proposals. The County's selected collection method may not be the lowest cost collection method. The County may consider factors including but not limited to, cost per cubic yard, readiness to implement, regulatory compliance, and waste diversion potential, when deciding upon a collection method for each Service Area.

Instructions: Proposer shall enter proposed monthly rates in the blue boxes below and the discounted rate for Customers who have a waiver/exemption for Organic Waste Collection Services in the yellow box below. Proposer must submit a proposal/bid for each collection method: Three-Container, Two-Container and One-Container collection methods. Failure to do so may result in the proposal/bid being rejected as nonresponsive. All proposers should include the 14% franchise fee in their proposed rates. Proposers shall not change the numbers in Column D- Estimated No. of Collections per Week. Column E will autocalculate the Proposed Annual Amount for each service. The Proposed Total Annual Amounts for Collection Services of the County selected collection method will be used for the evaluation evaluated. Proposer is responsible for ensuring accuracy of calculations.

Multifamily Collection Services (Three-Container)

Note: The following rates apply to Multifamily Customers. The Minimum Default Collection Service rate includes a minimum base rate for Refuse, Organic Waste, and Recyclables Collection Services. The minimum base rate for Refuse includes the equivalent of 64 gallons of weekly Organic Waste and 96 gallons of weekly Recycling Collection Service per Customer, both at no additional charge. Recycling rates shall be no more than half of the Refuse rates and Organic Waste rates shall be no greater than the Refuse rates.

Disposal Facility Name: **GRAND CENTRAL RECYCLING AND TRANSFER** Rate (Per Ton): **\$77.84**
 Backup Disposal Facility Name: **LACSD** Rate (Per Ton): **\$77.84**

Service Description	Collection Frequency (No. of Pickups per Week)	Monthly Unit Price/Rate	(Discount Rate 3%)	Monthly Unit Price/Rate (Final Discounted Rate)	*Estimated No. of Collections per Week	Annual Amount (Discounted Monthly Unit Price/Rate x Estimated No. of Collections per Week x 12)
32-Gallon Cart	1	\$33.16	3.00%	\$32.17		\$0.00
	2	\$54.96	3.00%	\$53.31		\$0.00
	3	\$74.38	3.00%	\$72.16		\$0.00
	4	\$93.16	3.00%	\$90.36		\$0.00
	5	\$111.94	3.00%	\$108.55		\$0.00
	6	\$128.87	3.00%	\$125.00		\$0.00
	7	\$145.82	3.00%	\$141.45		\$0.00
64-Gallon Cart	1	\$37.58	3.00%	\$36.45		\$0.00
	2	\$62.29	3.00%	\$60.42		\$0.00
	3	\$84.31	3.00%	\$81.78		\$0.00
	4	\$105.56	3.00%	\$102.39		\$0.00
	5	\$126.83	3.00%	\$123.03		\$0.00
	6	\$146.05	3.00%	\$141.67		\$0.00
	7	\$165.26	3.00%	\$160.30		\$0.00
96-Gallon Cart	1	\$44.22	3.00%	\$42.89		\$0.00
	2	\$73.28	3.00%	\$71.08		\$0.00
	3	\$99.18	3.00%	\$96.20		\$0.00
	4	\$124.19	3.00%	\$120.46		\$0.00
	5	\$149.22	3.00%	\$144.74		\$0.00
	6	\$171.82	3.00%	\$166.67		\$0.00
	7	\$194.43	3.00%	\$188.60		\$0.00
1 CY Dumpster	1	\$108.27	3.00%	\$105.02	2	\$2,520.53
	2	\$216.52	3.00%	\$210.02	1	\$2,520.26
	3	\$324.79	3.00%	\$315.05		\$0.00
	4	\$361.17	3.00%	\$350.33		\$0.00
	5	\$393.94	3.00%	\$382.12		\$0.00
	6	\$443.44	3.00%	\$430.14		\$0.00
	7	\$492.93	3.00%	\$478.14		\$0.00
1.5 CY Dumpster	1	\$117.46	3.00%	\$113.94	16	\$21,875.76
	2	\$234.93	3.00%	\$227.88	1	\$2,734.59
	3	\$352.39	3.00%	\$341.82	1	\$4,101.82
	4	\$397.97	3.00%	\$386.03	5	\$23,161.85
	5	\$439.95	3.00%	\$426.75		\$0.00
	6	\$498.65	3.00%	\$483.69		\$0.00
	7	\$557.34	3.00%	\$540.62		\$0.00
2 CY Dumpster	1	\$126.68	3.00%	\$122.86	58	\$85,510.70
	2	\$253.33	3.00%	\$245.73	59	\$162,181.87
	3	\$380.00	3.00%	\$368.60	64	\$283,084.80
	4	\$434.77	3.00%	\$421.73	11	\$55,667.95
	5	\$485.95	3.00%	\$471.37		\$0.00
	6	\$553.85	3.00%	\$537.23	3	\$19,340.44
	7	\$621.76	3.00%	\$603.11		\$0.00

3 CY Dumpster	1	\$145.07	3.00%	\$140.72	7	\$11,820.30
	2	\$290.14	3.00%	\$281.44	3	\$10,131.69
	3	\$435.20	3.00%	\$422.14	27	\$136,774.66
	4	\$508.39	3.00%	\$493.14	12	\$71,011.92
	5	\$577.97	3.00%	\$560.63		\$0.00
	6	\$664.27	3.00%	\$644.34	2	\$15,464.21
	7	\$750.57	3.00%	\$728.05		\$0.00
4 CY Dumpster	1	\$163.47	3.00%	\$158.57		\$0.00
	2	\$328.94	3.00%	\$317.13	1	\$3,805.58
	3	\$490.41	3.00%	\$475.70		\$0.00
	4	\$581.99	3.00%	\$564.53		\$0.00
	5	\$669.98	3.00%	\$649.88		\$0.00
	6	\$774.68	3.00%	\$751.44		\$0.00
	7	\$879.38	3.00%	\$853.00		\$0.00
6 CY Dumpster	1	\$200.28	3.00%	\$194.27		\$0.00
	2	\$400.55	3.00%	\$388.53		\$0.00
	3	\$600.83	3.00%	\$582.81		\$0.00
	4	\$729.21	3.00%	\$707.33		\$0.00
	5	\$854.01	3.00%	\$828.39		\$0.00
	6	\$995.52	3.00%	\$965.65		\$0.00
	7	\$1,137.03	3.00%	\$1,102.92		\$0.00
8 CY to 40 CY Roll-offs	1	\$220.00	3.00%	\$213.40	5	\$12,804.00
	2	\$440.00	3.00%	\$426.80		\$0.00
	3	\$880.00	3.00%	\$853.60		\$0.00
	4	\$1,760.00	3.00%	\$1,707.20		\$0.00
	5	\$3,520.00	3.00%	\$3,414.40		\$0.00
	6	\$7,040.00	3.00%	\$6,828.80		\$0.00
	7	\$14,080.00	3.00%	\$13,657.60		\$0.00
Compactor	1	\$250.00	3.00%	\$242.50		\$0.00
	2	\$500.00	3.00%	\$485.00		\$0.00
	3	\$1,000.00	3.00%	\$970.00		\$0.00
	4	\$2,000.00	3.00%	\$1,940.00		\$0.00
	5	\$4,000.00	3.00%	\$3,880.00		\$0.00
	6	\$8,000.00	3.00%	\$7,760.00		\$0.00
	7	\$16,000.00	3.00%	\$15,520.00		\$0.00
Total Proposed Annual Amount (2A)						\$924,512.94

Permanent Roll-Offs and Compactors: All 8, 10, 20, 30, 40 CY Roll-offs and compactors are pull rates only; total cost will be based on actual Disposal and/or Processing costs. Rates charged to Customers should include the total cost for pull, Processing and Disposal rates.
Temporary Roll-offs (Non-permanent service of no more than 30 consecutive days at Customer's site): Shall be charged as accordingly to the Service Rates indicated above and may charge an additional daily rental fee (See Extra Services Fees).

Discounted Rates for Customers with Waivers and Exemptions
 Proposer must provide discounted rates for Customers that have been issued waivers and exemptions for part or all of Collection Services. Proposer must insert the discounted rate in the yellow box below for Customers that have been issued a waiver/exemption for Organic Waste Collection Services.

Customer Scenarios	Monthly Rate
1) Customer that Self-Hauls Refuse, Recyclables and Organic Waste.	\$__0__ for Solid Waste Collection Services
2) Customer that Self-Hauls Refuse only (Customer still needs to subscribe to Organic Waste and Recyclables Collection)	\$__0__ for Refuse
3) Customer that Self-Hauls Organic Waste and has an Organic Waste waiver/exemption (Customer still needs to subscribe to Refuse and Recyclables Collection).	The Monthly Rate to Customer should be \$ 0 for Organic Waste. For Refuse, all monthly rates should be discounted by \$13 of the Solid Waste Collection Service Rates.

*Estimated No. of Collections per Week is based on 2019 Customer data submitted by the current non-exclusive commercial franchise waste haulers. Each of the Service Areas have different Customer counts.

Additional Entry: (Proposer may use this space to add additional information such as additional facilities and if Proposer would like to add any additional service levels and Container sizes that may have not been identified above)
 TEMP ROLLOFF \$538.00 PER TON \$77.84

The undersigned Proposer offers to perform the work described in the Request for Proposals (RFP) for the following price(s). The Proposer rate(s) (hourly, monthly, etc.) shall include all administrative costs, franchise fees, labor, supervision, overtime, materials, transportation, taxes, equipment, and supplies unless stated otherwise in the RFP. The Proposer understands and agrees that the quantities set forth in the Schedule of Prices by the County are only estimates are based on current hauler submittals. Any unit prices quoted by the Proposer in this Schedule of Prices will apply to the actual quantities of work. The Proposer may use the estimates to develop its cost and rate proposal. The Proposer understands and agrees that each of the Service Areas have different Customer counts. County makes no representation or warranties of any kind, expressed or implied, as to the accuracy of the information set forth in the Schedule of Prices. County will not be liable for any damages or loss of any nature, including, but not limited to, lost profits, resulting from the estimates provided by the County. Proposer agrees to indemnify and hold the County harmless with respect to any issues, disputes, claims, lawsuits resulting from the estimates provided by the County in this solicitation, and in particular, as set forth in the Schedule of Prices. It is the responsibility of the proposer to undertake, at its sole cost, any verification of any and all information necessary for the preparation and submittal of a response to this RFP.

It is the County's sole discretion to select the collection method for each Service Area after receipt of all proposals. The County's selected collection method may not be the lowest cost collection method. The County may consider factors including but not limited to, cost per cubic yard, readiness to implement, regulatory compliance, and waste diversion potential, when deciding upon a collection method for each Service Area.

Instructions: Proposer shall enter proposed monthly rates in the blue boxes below. Proposer must submit a proposal/bid for each collection method: Three-Container, Two-Container and One-Container collection methods. Failure to do so may result in the proposal/bid being rejected as nonresponsive. All proposers should include the 14% franchise fee in their proposed rates. Proposers shall not change the numbers in Column D- Estimated No. of Collections per Week. Column E will autocalculate the Proposed Annual Amount for each service. The Proposed Total Annual Amounts for Collection Services of the County selected collection method will be used for the evaluation evaluated. Proposer is responsible for ensuring accuracy of calculations.

Additional Containers for Recyclables

Note: The following rates apply to Multifamily Customers. These are the rates that are requested in addition to the Minimum Default Collection Service. Recycling rates shall be no more than half of the Refuse rates. The Minimum Default Collection Service includes the equivalent of 96 gallons of weekly Recycling Collection Service per Customer at no additional charge.

Disposal Facility Name: GRAND CENTRAL RECYCLING AND TRANSFER Rate (Per Ton): \$77.84
Backup Disposal Facility Name: LACSD Rate (Per Ton): \$77.84

Service Description	Collection Frequency (No. of Pickups per Week)	Monthly Unit Price/Rate	(Discount Rate 3%)	Monthly Unit Price/Rate (Final Discounted Rate)	*Estimated No. of Collections per Week	Annual Amount (Discounted Monthly Unit Price/Rate x Estimated No. of Collections per Week x 12)
32-Gallon Cart	1	\$16.58	3.00%	\$16.08		\$0.00
	2	\$27.48	3.00%	\$26.66		\$0.00
	3	\$37.20	3.00%	\$36.08		\$0.00
	4	\$46.58	3.00%	\$45.18		\$0.00
	5	\$55.96	3.00%	\$54.28		\$0.00
	6	\$64.44	3.00%	\$62.50		\$0.00
	7	\$72.91	3.00%	\$70.72		\$0.00
64-Gallon Cart	1	\$18.79	3.00%	\$18.23		\$0.00
	2	\$31.15	3.00%	\$30.21		\$0.00
	3	\$42.16	3.00%	\$40.89		\$0.00
	4	\$52.78	3.00%	\$51.20		\$0.00
	5	\$63.42	3.00%	\$61.51		\$0.00
	6	\$73.03	3.00%	\$70.83		\$0.00
	7	\$82.63	3.00%	\$80.15		\$0.00
96-Gallon Cart	1	\$22.11	3.00%	\$21.45	1	\$257.36
	2	\$36.64	3.00%	\$35.54		\$0.00
	3	\$49.59	3.00%	\$48.10		\$0.00
	4	\$62.10	3.00%	\$60.23		\$0.00
	5	\$74.61	3.00%	\$72.37		\$0.00
	6	\$85.91	3.00%	\$83.33		\$0.00
	7	\$97.22	3.00%	\$94.30		\$0.00
1 CY Dumpster	1	\$54.14	3.00%	\$52.51	17	\$10,712.23
	2	\$108.26	3.00%	\$105.01	2	\$2,520.29
	3	\$162.40	3.00%	\$157.52	1	\$1,890.28
	4	\$180.59	3.00%	\$175.17	5	\$10,510.05
	5	\$196.97	3.00%	\$191.06		\$0.00
	6	\$221.72	3.00%	\$215.07		\$0.00
	7	\$246.47	3.00%	\$239.07		\$0.00
1.5 CY Dumpster	1	\$58.73	3.00%	\$56.97	58	\$39,649.80
	2	\$117.47	3.00%	\$113.94	55	\$75,201.09
	3	\$176.20	3.00%	\$170.91	64	\$131,258.23
	4	\$198.99	3.00%	\$193.02	11	\$25,478.04
	5	\$219.98	3.00%	\$213.38		\$0.00
	6	\$249.33	3.00%	\$241.85	3	\$8,706.43
	7	\$278.67	3.00%	\$270.31		\$0.00
2 CY Dumpster	1	\$63.33	3.00%	\$61.43	7	\$5,160.13
	2	\$126.67	3.00%	\$122.87	3	\$4,423.14
	3	\$190.00	3.00%	\$184.30	27	\$59,713.20
	4	\$217.39	3.00%	\$210.86	12	\$30,364.34
	5	\$242.98	3.00%	\$235.69		\$0.00
	6	\$276.93	3.00%	\$268.62		\$0.00
	7	\$310.88	3.00%	\$301.55		\$0.00

3 CY Dumpster							
	1	\$72.54	3.00%	\$70.36			\$0.00
	2	\$145.07	3.00%	\$140.72	1		\$1,688.61
	3	\$217.60	3.00%	\$211.07			\$0.00
	4	\$254.20	3.00%	\$246.57			\$0.00
	5	\$288.99	3.00%	\$280.32			\$0.00
	6	\$332.14	3.00%	\$322.17			\$0.00
	7	\$375.29	3.00%	\$364.03			\$0.00
4 CY Dumpster							
	1	\$81.74	3.00%	\$79.28			\$0.00
	2	\$163.47	3.00%	\$158.57			\$0.00
	3	\$245.21	3.00%	\$237.85			\$0.00
	4	\$291.00	3.00%	\$282.27			\$0.00
	5	\$334.99	3.00%	\$324.94			\$0.00
	6	\$387.34	3.00%	\$375.72			\$0.00
	7	\$439.69	3.00%	\$426.50			\$0.00
6 CY Dumpster							
	1	\$100.14	3.00%	\$97.14			\$0.00
	2	\$200.28	3.00%	\$194.27			\$0.00
	3	\$300.42	3.00%	\$291.40			\$0.00
	4	\$364.61	3.00%	\$353.67			\$0.00
	5	\$427.01	3.00%	\$414.19			\$0.00
	6	\$497.76	3.00%	\$482.83			\$0.00
	7	\$568.52	3.00%	\$551.46			\$0.00
8 CY to 40 CY Roll-offs							
	1	\$220.00	3.00%	\$213.40	5		\$12,804.00
	2	\$440.00	3.00%	\$426.80			\$0.00
	3	\$880.00	3.00%	\$853.60			\$0.00
	4	\$1,760.00	3.00%	\$1,707.20			\$0.00
	5	\$3,520.00	3.00%	\$3,414.40			\$0.00
	6	\$7,040.00	3.00%	\$6,828.80			\$0.00
	7	\$14,080.00	3.00%	\$13,657.60			\$0.00
Compactor							
	1	\$250.00	3.00%	\$242.50			\$0.00
	2	\$500.00	3.00%	\$485.00			\$0.00
	3	\$1,000.00	3.00%	\$970.00			\$0.00
	4	\$2,000.00	3.00%	\$1,940.00			\$0.00
	5	\$4,000.00	3.00%	\$3,880.00			\$0.00
	6	\$8,000.00	3.00%	\$7,760.00			\$0.00
	7	\$16,000.00	3.00%	\$15,520.00			\$0.00
Total Proposed Annual Amount (2B)							\$420,337.22
<p>Permanent Roll-Offs and Compactors: All 8, 10, 20, 30, 40 CY Roll-offs and compactors are pull rates only; total cost will be based on actual Disposal and/or Processing costs. Rates charged to Customers should include the total cost for pull, Processing and Disposal rates.</p> <p>Temporary Roll-offs (Non-permanent service of no more than 30 consecutive days at Customer's site): Shall be charged as accordingly to the Service Rates indicated above and may charge an additional daily rental fee (See Extra Services Fees).</p>							
<p>*Estimated No. of Collections per Week is based on 2019 Customer data submitted by the current non-exclusive commercial franchise waste haulers. Each of the Service Areas have different Customer counts.</p> <p>Additional Entry: (Proposer may use this space to add additional information such as additional facilities and if Proposer would like to add any additional service levels and Container sizes that may have not been identified above)</p> <p style="text-align: center;">TEMP ROLLOFF \$538.00 PER TON \$77.84</p>							

he undersigned Proposer offers to perform the work described in the Request for Proposals (RFP) for the following price(s). The Proposer rate(s) (hourly, monthly, etc.) shall include all administrative costs, franchise fees, labor, supervision, overtime, materials, transportation, taxes, equipment, and supplies unless stated otherwise in the RFP. The Proposer understands and agrees that the quantities set forth in the Schedule of Prices by the County are only estimates are based on current hauler submittals. Any unit prices quoted by the Proposer in this Schedule of Prices will apply to the actual quantities of work. The Proposer may use the estimates to develop its cost and rate proposal. The Proposer understands and agrees that each of the Service Areas have different Customer counts. County makes no representation or warranties of any kind, expressed or implied, as to the accuracy of the information set forth in the Schedule of Prices. County will not be liable for any damages or loss of any nature, including, but not limited to, lost profits, resulting from the estimates provided by the County. Proposer agrees to indemnify and hold the County harmless with respect to any issues, disputes, claims, lawsuits resulting from the estimates provided by the County in this solicitation, and in particular, as set forth in the Schedule of Prices. It is the responsibility of the proposer to undertake, at its sole cost, any verification of any and all information necessary for the preparation and submittal of a response to this RFP.

It is the County's sole discretion to select the collection method for each Service Area after receipt of all proposals. The County's selected collection method may not be the lowest cost collection method. The County may consider factors including but not limited to, cost per cubic yard, readiness to implement, regulatory compliance, and waste diversion potential, when deciding upon a collection method for each Service Area.

Instructions: Proposer shall enter proposed monthly rates in the blue boxes below. Proposer must submit a proposal/bid for each collection method: Three-Container, Two-Container and One-Container collection methods. Failure to do so may result in the proposal/bid being rejected as nonresponsive. All proposers should include the 14% franchise fee in their proposed rates. Proposers shall not change the numbers in Column D- Estimated No. of Collections per Week. Column E will autocalculate the Proposed Annual Amount for each service. The Proposed Total Annual Amounts for Collection Services of the County selected collection method will be used for the evaluation evaluated. Proposer is responsible for ensuring accuracy of calculations.

Additional Containers for Organic Waste

Note: The following rates apply to Multifamily Customers. These are the rates that are requested in addition to the Minimum Default Collection Service. Organic Waste rates shall be no greater than the Refuse rates. The Minimum Default Collection Service includes the equivalent of 64 gallons of weekly Organic Waste Collection Service per Customer at no additional charge.

Disposal Facility Name: GRAND CENTRAL RECYCLING AND TRANSFER Rate (Per Ton): \$105.00
Backup Disposal Facility Name: LACSD Rate (Per Ton): \$112.07

Service Description	Collection Frequency (No. of Pickups per Week)	Monthly Unit Price/Rate	(Discount Rate 3%)	Monthly Unit Price/Rate (Final Discounted Rate)	*Estimated No. of Collections per Week	Annual Amount (Discounted Monthly Unit Price/Rate x Estimated No. of Collections per Week x 12)
32-Gallon Cart	1	\$33.16	3.00%	\$32.17		\$0.00
	2	\$54.96	3.00%	\$53.31		\$0.00
	3	\$74.39	3.00%	\$72.16		\$0.00
	4	\$93.15	3.00%	\$90.36		\$0.00
	5	\$111.91	3.00%	\$108.55		\$0.00
	6	\$128.87	3.00%	\$125.00		\$0.00
	7	\$145.82	3.00%	\$141.45		\$0.00
64-Gallon Cart	1	\$37.58	3.00%	\$36.45	1	\$437.43
	2	\$62.29	3.00%	\$60.42		\$0.00
	3	\$84.31	3.00%	\$81.78		\$0.00
	4	\$105.56	3.00%	\$102.39		\$0.00
	5	\$126.83	3.00%	\$123.03		\$0.00
	6	\$146.05	3.00%	\$141.67		\$0.00
	7	\$165.26	3.00%	\$160.30		\$0.00
96-Gallon Cart	1	\$44.22	3.00%	\$42.89	1	\$514.72
	2	\$73.28	3.00%	\$71.08	1	\$852.98
	3	\$99.18	3.00%	\$96.20		\$0.00
	4	\$124.19	3.00%	\$120.46		\$0.00
	5	\$149.22	3.00%	\$144.74		\$0.00
	6	\$171.82	3.00%	\$166.67		\$0.00
	7	\$194.43	3.00%	\$188.60		\$0.00
1 CY Dumpster	1	\$87.19	3.00%	\$84.58	74	\$75,103.70
	2	\$149.52	3.00%	\$145.03	56	\$97,463.12
	3	\$206.70	3.00%	\$200.50	65	\$156,391.49
	4	\$262.42	3.00%	\$254.54	16	\$48,872.36
	5	\$318.14	3.00%	\$308.60		\$0.00
	6	\$369.90	3.00%	\$358.81	3	\$12,917.07
	7	\$421.67	3.00%	\$409.02		\$0.00
1.5 CY Dumpster	1	\$101.52	3.00%	\$98.46	7	\$8,272.22
	2	\$178.19	3.00%	\$172.84	3	\$6,222.22
	3	\$249.70	3.00%	\$242.21	27	\$78,475.87
	4	\$319.75	3.00%	\$310.15	12	\$44,662.12
	5	\$389.80	3.00%	\$378.11		\$0.00
	6	\$455.90	3.00%	\$442.22	2	\$10,613.34
	7	\$522.00	3.00%	\$506.34		\$0.00

2 CY Dumpster	1	\$126.66	3.00%	\$122.86		\$0.00
	2	\$253.33	3.00%	\$245.73	1	\$2,948.76
	3	\$380.00	3.00%	\$368.60		\$0.00
	4	\$434.77	3.00%	\$421.73		\$0.00
	5	\$485.95	3.00%	\$471.37		\$0.00
	6	\$553.85	3.00%	\$537.23		\$0.00
	7	\$621.76	3.00%	\$603.11		\$0.00
3 CY Dumpster	1	\$145.07	3.00%	\$140.72		\$0.00
	2	\$290.14	3.00%	\$281.44		\$0.00
	3	\$435.20	3.00%	\$422.14		\$0.00
	4	\$508.39	3.00%	\$493.14		\$0.00
	5	\$577.97	3.00%	\$560.63		\$0.00
	6	\$664.27	3.00%	\$644.34		\$0.00
	7	\$750.57	3.00%	\$728.05		\$0.00
8 CY to 40 CY Roll-offs	1	\$163.47	3.00%	\$158.57	5	\$9,513.95
	2	\$326.94	3.00%	\$317.13		\$0.00
	3	\$490.41	3.00%	\$475.70		\$0.00
	4	\$581.99	3.00%	\$564.53		\$0.00
	5	\$669.98	3.00%	\$649.88		\$0.00
	6	\$774.68	3.00%	\$751.44		\$0.00
	7	\$879.38	3.00%	\$853.00		\$0.00
Compactor	1	\$200.28	3.00%	\$194.27		\$0.00
	2	\$400.55	3.00%	\$388.53		\$0.00
	3	\$600.83	3.00%	\$582.81		\$0.00
	4	\$729.21	3.00%	\$707.33		\$0.00
	5	\$854.01	3.00%	\$828.39		\$0.00
	6	\$995.52	3.00%	\$965.65		\$0.00
	7	\$1,137.03	3.00%	\$1,102.92		\$0.00
Total Proposed Annual Amount (2C)						\$553,261.35
Additional Entry: (Proposer may use this space to add additional information such as additional facilities and if Proposer would like to add any additional service levels and Container sizes that may have not been identified above) <p style="text-align: right;">TEMP ROLLOFF \$538.00 PER TON \$77.84</p>						
<small>*Estimated No. of Collections per Week is based on 2019 Customer data submitted by the current non-exclusive commercial franchise waste haulers. Each of the Service Areas have different Customer counts.</small>						
Additional Entry: (Proposer may use this space to add additional information such as additional facilities and if Proposer would like to add any additional service levels and Container sizes that may have not been identified above)						

The undersigned Proposer offers to perform the work described in the Request for Proposals (RFP) for the following price(s). The Proposer rate(s) (hourly, monthly, etc.) shall include all administrative costs, franchise fees, labor, supervision, overtime, materials, transportation, taxes, equipment, and supplies unless stated otherwise in the RFP. The Proposer understands and agrees that the quantities set forth in the Schedule of Prices by the County are only estimates are based on current hauler submittals. Any unit prices quoted by the Proposer in this Schedule of Prices will apply to the actual quantities of work. The Proposer may use the estimates to develop its cost and rate proposal. The Proposer understands and agrees that each of the Service Areas have different Customer counts. County makes no representation or warranties of any kind, expressed or implied, as to the accuracy of the information set forth in the Schedule of Prices. County will not be liable for any damages or loss of any nature, including, but not limited to, lost profits, resulting from the estimates provided by the County. Proposer agrees to indemnify and hold the County harmless with respect to any issues, disputes, claims, lawsuits resulting from the estimates provided by the County in this solicitation, and in particular, as set forth in the Schedule of Prices. It is the responsibility of the proposer to undertake, at its sole cost, any verification of any and all information necessary for the preparation and submittal of a response to this RFP.

It is the County's sole discretion to select the collection method for each Service Area after receipt of all proposals. The County's selected collection method may not be the lowest cost collection method. The County may consider factors including but not limited to, cost per cubic yard, readiness to implement, regulatory compliance, and waste diversion potential, when deciding upon a collection method for each Service Area.

Instructions: Proposer shall enter proposed monthly rates in the blue boxes below and the discounted rate for Customers who have a waiver/exemption for Organic Waste Collection Services in the yellow box below. Proposer must submit a proposal/bid for each collection method: Three-Container, Two-Container and One-Container collection methods. Failure to do so may result in the proposal/bid being rejected as nonresponsive. All proposers should include the 14% franchise fee in their proposed rates. Proposers shall not change the numbers in Column D- Estimated No. of Collections per Week. Column E will autocalculate the Proposed Annual Amount for each service. The Proposed Total Annual Amounts for Collection Services of the County selected collection method will be used for the evaluation evaluated. Proposer is responsible for ensuring accuracy of calculations.

Residential Collection Services (Three-Container)

Note: The following rates apply to Residential (Single Family) Customers. The Minimum Default Collection Service rate includes a minimum base rate for Refuse, Organic Waste, and Recyclables Collection Services. The minimum base rate for Refuse includes the equivalent of 64 gallons of weekly Organic Waste and 96 gallons of weekly Recycling Collection Service per Customer, both at no additional charge. Recycling rates shall be no more than half of the Refuse rates and Organic Waste rates shall be no greater than the Refuse rates.

Disposal Facility Name: GRAND CENTRAL RECYCLING AND TRANSFER Rate (Per Ton): \$77.84
Backup Disposal Facility Name: LACSD Rate (Per Ton): \$77.84

Service Description	Collection Frequency (No. of Pickups per Week)	Monthly Unit Price/Rate	(Discount Rate 3%)	Monthly Unit Price/Rate (Final Discounted Rate)	*Estimated No. of Collections per Week	Annual Amount (Discounted Monthly Unit Price/Rate x Estimated No. of Collections per Week x 12)
32-Gallon Cart	1	\$33.16	3.00%	\$32.17		\$0.00
	2	\$54.96	3.00%	\$53.31		\$0.00
	3	\$74.39	3.00%	\$72.16		\$0.00
	4	\$93.15	3.00%	\$90.36		\$0.00
	5	\$111.91	3.00%	\$108.55		\$0.00
	6	\$128.87	3.00%	\$125.00		\$0.00
	7	\$145.82	3.00%	\$141.45		\$0.00
64-Gallon Cart	1	\$37.58	3.00%	\$36.45		\$0.00
	2	\$62.29	3.00%	\$60.42		\$0.00
	3	\$84.31	3.00%	\$81.78		\$0.00
	4	\$105.56	3.00%	\$102.39		\$0.00
	5	\$126.83	3.00%	\$123.03		\$0.00
	6	\$146.05	3.00%	\$141.67		\$0.00
	7	\$165.26	3.00%	\$160.30		\$0.00
96-Gallon Cart	1	\$44.22	3.00%	\$42.89		\$0.00
	2	\$73.28	3.00%	\$71.08		\$0.00
	3	\$99.18	3.00%	\$96.20		\$0.00
	4	\$124.19	3.00%	\$120.46		\$0.00
	5	\$149.22	3.00%	\$144.74		\$0.00
	6	\$171.82	3.00%	\$166.67		\$0.00
	7	\$194.43	3.00%	\$188.60		\$0.00
1 CY Dumpster	1	\$108.27	3.00%	\$105.02	1	\$1,260.26
	2	\$216.52	3.00%	\$210.02		\$0.00
	3	\$324.79	3.00%	\$315.05		\$0.00
	4	\$361.17	3.00%	\$350.33		\$0.00
	5	\$393.94	3.00%	\$382.12		\$0.00
	6	\$443.44	3.00%	\$430.14		\$0.00
	7	\$492.93	3.00%	\$478.14		\$0.00
1.5 CY Dumpster	1	\$117.46	3.00%	\$113.94	28	\$38,282.56
	2	\$234.93	3.00%	\$227.88		\$0.00
	3	\$352.39	3.00%	\$341.82		\$0.00
	4	\$397.97	3.00%	\$386.03		\$0.00
	5	\$439.95	3.00%	\$426.75		\$0.00
	6	\$498.65	3.00%	\$483.69		\$0.00
	7	\$557.34	3.00%	\$540.62		\$0.00
2 CY Dumpster	1	\$126.66	3.00%	\$122.86	37	\$54,549.93
	2	\$253.33	3.00%	\$245.73		\$0.00
	3	\$380.00	3.00%	\$368.60		\$0.00
	4	\$434.77	3.00%	\$421.73		\$0.00
	5	\$485.95	3.00%	\$471.37		\$0.00
	6	\$553.85	3.00%	\$537.23		\$0.00
	7	\$621.76	3.00%	\$603.11		\$0.00

3 CY Dumpster	1	\$145.07	3.00%	\$140.72	177	\$298,884.82
	2	\$290.14	3.00%	\$281.44	28	\$94,562.43
	3	\$435.20	3.00%	\$422.14	2	\$10,131.46
	4	\$508.39	3.00%	\$493.14	10	\$59,176.60
	5	\$577.97	3.00%	\$560.63		\$0.00
	6	\$664.27	3.00%	\$644.34	29	\$224,230.98
	7	\$750.57	3.00%	\$728.05		\$0.00
4 CY Dumpster	1	\$163.47	3.00%	\$158.57	2	\$3,805.58
	2	\$326.94	3.00%	\$317.13		\$0.00
	3	\$490.41	3.00%	\$475.70	1	\$5,708.37
	4	\$581.99	3.00%	\$564.53		\$0.00
	5	\$669.98	3.00%	\$649.88		\$0.00
	6	\$774.68	3.00%	\$751.44		\$0.00
	7	\$879.38	3.00%	\$853.00		\$0.00
6 CY Dumpster	1	\$200.28	3.00%	\$194.27		\$0.00
	2	\$400.55	3.00%	\$388.53		\$0.00
	3	\$600.83	3.00%	\$582.81		\$0.00
	4	\$729.21	3.00%	\$707.33		\$0.00
	5	\$854.01	3.00%	\$828.39		\$0.00
	6	\$995.52	3.00%	\$965.65		\$0.00
	7	\$1,137.03	3.00%	\$1,102.92		\$0.00
8 CY to 40 CY Roll-offs	1	\$220.00	3.00%	\$213.40	2	\$5,121.60
	2	\$440.00	3.00%	\$426.80		\$0.00
	3	\$880.00	3.00%	\$853.60		\$0.00
	4	\$1,760.00	3.00%	\$1,707.20		\$0.00
	5	\$3,520.00	3.00%	\$3,414.40		\$0.00
	6	\$7,040.00	3.00%	\$6,828.80		\$0.00
	7	\$14,080.00	3.00%	\$13,657.60		\$0.00
Compactor	1	\$250.00	3.00%	\$242.50		\$0.00
	2	\$500.00	3.00%	\$485.00		\$0.00
	3	\$1,000.00	3.00%	\$970.00		\$0.00
	4	\$2,000.00	3.00%	\$1,940.00		\$0.00
	5	\$4,000.00	3.00%	\$3,880.00		\$0.00
	6	\$8,000.00	3.00%	\$7,760.00		\$0.00
	7	\$16,000.00	3.00%	\$15,520.00		\$0.00
Total Proposed Annual Amount (3A)						\$795,714.59

Permanent Roll-Offs and Compactors: All 8, 10, 20, 30, 40 CY Roll-offs and compactors are pull rates only; total cost will be based on actual Disposal and/or Processing costs. Rates charged to Customers should include the total cost for pull, Processing and Disposal rates.

Temporary Roll-offs (Non-permanent service of no more than 30 consecutive days at Customer's site): Shall be charged as accordingly to the Service Rates indicated above and may charge an additional daily rental fee (See Extra Services Fees).

Discounted Rates for Customers with Waivers and Exemptions

Proposer must provide discounted rates for Customers that have been issued waivers and exemptions for part or all of Collection Services. Proposer must insert the discounted rate in the yellow box below for Customers that have been issued a waiver/exemption for Organic Waste Collection Services.

Customer Scenarios

Monthly Rate

1) Customer that Self-Hauls Refuse, Recyclables and Organic Waste.

\$__0__ for Solid Waste Collection Services

2) Customer that Self-Hauls Refuse only (Customer still needs to subscribe to Organic Waste and Recyclables Collection).

\$__0__ for Refuse

3) Customer that Self-Hauls Organic Waste and has an Organic Waste waiver/exemption (Customer still needs to subscribe to Refuse and Recyclables Collection).

The Monthly Rate to Customer should be \$ 0. for Organic Waste.
For Refuse, all monthly rates should be discounted by \$13 of the Solid Waste Collection Service Rates.

*Estimated No. of Collections per Week is based on 2019 Customer data submitted by the current non-exclusive commercial franchise waste haulers. Each of the Service Areas have different Customer counts.

Additional Entry: (Proposer may use this space to add additional information such as additional facilities and if Proposer would like to add any additional service levels and Container sizes that may have not been identified above)

TEMP ROLLOFF \$538.00 PER TON \$77.84

The undersigned Proposer offers to perform the work described in the Request for Proposals (RFP) for the following price(s). The Proposer rate(s) (hourly, monthly, etc.) shall include all administrative costs, franchise fees, labor, supervision, overtime, materials, transportation, taxes, equipment, and supplies unless stated otherwise in the RFP. The Proposer understands and agrees that the quantities set forth in the Schedule of Prices by the County are only estimates and are based on current hauler submittals. Any unit prices quoted by the Proposer in this Schedule of Prices will apply to the actual quantities of work. The Proposer may use the estimates to develop its cost and rate proposal. The Proposer understands and agrees that each of the Service Areas have different Customer counts. County makes no representation or warranties of any kind, expressed or implied, as to the accuracy of the information set forth in the Schedule of Prices. County will not be liable for any damages or loss of any nature, including, but not limited to, lost profits, resulting from the estimates provided by the County. Proposer agrees to indemnify and hold the County harmless with respect to any issues, disputes, claims, lawsuits resulting from the estimates provided by the County in this solicitation, and in particular, as set forth in the Schedule of Prices. It is the responsibility of the proposer to undertake, at its sole cost, any verification of any and all information necessary for the preparation and submittal of a response to this RFP.

It is the County's sole discretion to select the collection method for each Service Area after receipt of all proposals. The County's selected collection method may not be the lowest cost collection method. The County may consider factors including but not limited to, cost per cubic yard, readiness to implement, regulatory compliance, and waste diversion potential, when deciding upon a collection method for each Service Area.

Instructions: Proposer shall enter proposed monthly rates in the blue boxes below. Proposer must submit a proposal/bid for each collection method: Three-Container, Two-Container and One-Container collection methods. Failure to do so may result in the proposal/bid being rejected as nonresponsive. All proposers should include the 14% franchise fee in their proposed rates. Proposers shall not change the numbers in Column D- Estimated No. of Collections per Week. Column E will autocalculate the Proposed Annual Amount for each service. The Proposed Total Annual Amounts for Collection Services of the County selected collection method will be used for the evaluation evaluated. Proposer is responsible for ensuring accuracy of calculations.

Additional Containers for Recyclables

Note: The following rates apply to Residential (Single Family) Customers. These are the rates that are requested in addition to the Minimum Default Collection Service. Recycling rates shall be no more than half of the Refuse rates. The Minimum Default Collection Service includes the equivalent of 96 gallons of weekly Recycling Collection Service per Customer at no additional charge.

Disposal Facility Name: GRAND CENTRAL RECYCLING AND TRANSFER Rate (Per Ton): \$50.00
 Backup Disposal Facility Name: LACSD Rate (Per Ton): \$77.84

Service Description	Collection Frequency (No. of Pickups per Week)	Monthly Unit Price/Rate	(Discount Rate 3%)	Monthly Unit Price/Rate (Final Discounted Rate)	*Estimated No. of Collections per Week	Annual Amount (Discounted Monthly Unit Price/Rate x Estimated No. of Collections per Week x 12)
32-Gallon Cart	1	\$16.58	3.00%	\$16.06		\$0.00
	2	\$27.48	3.00%	\$26.66		\$0.00
	3	\$37.20	3.00%	\$36.08		\$0.00
	4	\$46.58	3.00%	\$45.18		\$0.00
	5	\$55.96	3.00%	\$54.28		\$0.00
	6	\$64.44	3.00%	\$62.50		\$0.00
	7	\$72.91	3.00%	\$70.72		\$0.00
64-Gallon Cart	1	\$18.79	3.00%	\$18.23	1	\$218.77
	2	\$31.15	3.00%	\$30.21		\$0.00
	3	\$42.16	3.00%	\$40.89		\$0.00
	4	\$52.78	3.00%	\$51.20		\$0.00
	5	\$63.42	3.00%	\$61.51		\$0.00
	6	\$73.03	3.00%	\$70.83		\$0.00
	7	\$82.63	3.00%	\$80.15		\$0.00
96-Gallon Cart	1	\$22.11	3.00%	\$21.45	69	\$16,728.43
	2	\$36.64	3.00%	\$35.54		\$0.00
	3	\$49.58	3.00%	\$48.10		\$0.00
	4	\$62.10	3.00%	\$60.23		\$0.00
	5	\$74.61	3.00%	\$72.37		\$0.00
	6	\$85.91	3.00%	\$83.33		\$0.00
	7	\$97.22	3.00%	\$94.30		\$0.00
1 CY Dumpster	1	\$54.14	3.00%	\$52.51	179	\$112,793.52
	2	\$108.26	3.00%	\$105.01	28	\$36,284.10
	3	\$162.40	3.00%	\$157.52	3	\$5,670.83
	4	\$180.58	3.00%	\$175.17	10	\$21,020.09
	5	\$196.97	3.00%	\$191.06		\$0.00
	6	\$221.72	3.00%	\$215.07	29	\$74,843.80
	7	\$246.47	3.00%	\$239.07		\$0.00
1.5 CY Dumpster	1	\$58.73	3.00%	\$56.97		\$0.00
	2	\$117.47	3.00%	\$113.94		\$0.00
	3	\$176.20	3.00%	\$170.91		\$0.00
	4	\$198.99	3.00%	\$193.02		\$0.00
	5	\$219.98	3.00%	\$213.38		\$0.00
	6	\$249.33	3.00%	\$241.85		\$0.00
	7	\$278.67	3.00%	\$270.31		\$0.00
2 CY Dumpster	1	\$63.33	3.00%	\$61.43		\$0.00
	2	\$126.67	3.00%	\$122.87		\$0.00
	3	\$190.00	3.00%	\$184.30		\$0.00
	4	\$217.38	3.00%	\$210.86		\$0.00
	5	\$242.98	3.00%	\$235.69		\$0.00
	6	\$276.93	3.00%	\$268.62		\$0.00
	7	\$310.88	3.00%	\$301.55		\$0.00
3 CY Dumpster	1	\$72.54	3.00%	\$70.36		\$0.00
	2	\$145.07	3.00%	\$140.72		\$0.00
	3	\$217.60	3.00%	\$211.07		\$0.00
	4	\$254.20	3.00%	\$246.57		\$0.00
	5	\$288.99	3.00%	\$280.32		\$0.00
	6	\$332.14	3.00%	\$322.17		\$0.00
	7	\$375.29	3.00%	\$364.03		\$0.00

4 CY Dumpster	1	\$81.74	3.00%	\$79.26		\$0.00
	2	\$163.47	3.00%	\$158.57		\$0.00
	3	\$245.21	3.00%	\$237.85		\$0.00
	4	\$291.00	3.00%	\$282.27		\$0.00
	5	\$334.99	3.00%	\$324.94		\$0.00
	6	\$387.34	3.00%	\$375.72		\$0.00
	7	\$439.69	3.00%	\$426.50		\$0.00
6 CY Dumpster	1	\$100.14	3.00%	\$97.14		\$0.00
	2	\$200.28	3.00%	\$194.27		\$0.00
	3	\$300.42	3.00%	\$291.40		\$0.00
	4	\$364.61	3.00%	\$353.67		\$0.00
	5	\$427.01	3.00%	\$414.19		\$0.00
	6	\$497.76	3.00%	\$482.83		\$0.00
	7	\$568.52	3.00%	\$551.46		\$0.00
8 CY to 40 CY Roll-offs	1	\$220.00	3.00%	\$213.40	2	\$5,121.60
	2	\$440.00	3.00%	\$426.80		\$0.00
	3	\$880.00	3.00%	\$853.60		\$0.00
	4	\$1,760.00	3.00%	\$1,707.20		\$0.00
	5	\$3,520.00	3.00%	\$3,414.40		\$0.00
	6	\$7,040.00	3.00%	\$6,828.80		\$0.00
	7	\$14,080.00	3.00%	\$13,657.60		\$0.00
Compactor	1	\$250.00	3.00%	\$242.50		\$0.00
	2	\$500.00	3.00%	\$485.00		\$0.00
	3	\$1,000.00	3.00%	\$970.00		\$0.00
	4	\$2,000.00	3.00%	\$1,940.00		\$0.00
	5	\$4,000.00	3.00%	\$3,880.00		\$0.00
	6	\$8,000.00	3.00%	\$7,760.00		\$0.00
	7	\$16,000.00	3.00%	\$15,520.00		\$0.00
Total Proposed Annual Amount (3B)						\$271,681.00
<p>Permanent Roll-Offs and Compactors: All 8, 10, 20, 30, 40 CY Roll-offs and compactors are pull rates only; total cost will be based on actual Disposal and/or Processing costs. Rates charged to Customers should include the total cost for pull, Processing and Disposal rates.</p> <p>Temporary Roll-offs (Non-permanent service of no more than 30 consecutive days at Customer's site): Shall be charged as accordingly to the Service Rates indicated above and may charge an additional daily rental fee (See Extra Services Fees).</p>						
<p>*Estimated No. of Collections per Week is based on 2019 Customer data submitted by the current non-exclusive commercial franchise waste haulers. Each of the Service Areas have different Customer counts.</p>						
<p>Additional Entry: (Proposer may use this space to add additional information such as additional facilities and if Proposer would like to add any additional service levels and Container sizes that may have not been identified above)</p> <p style="text-align: right;">TEMP ROLLOFF \$538.00 PER TON \$77.84</p>						

The undersigned Proposer offers to perform the work described in the Request for Proposals (RFP) for the following price(s). The Proposer rate(s) (hourly, monthly, etc.) shall include all administrative costs, franchise fees, labor, supervision, overtime, materials, transportation, taxes, equipment, and supplies unless stated otherwise in the RFP. The Proposer understands and agrees that the quantities set forth in the Schedule of Prices by the County are only estimates are based on current hauler submittals. Any unit prices quoted by the Proposer in this Schedule of Prices will apply to the actual quantities of work. The Proposer may use the estimates to develop its cost and rate proposal. The Proposer understands and agrees that each of the Service Areas have different Customer counts. County makes no representation or warranties of any kind, expressed or implied, as to the accuracy of the information set forth in the Schedule of Prices. County will not be liable for any damages or loss of any nature, including, but not limited to, lost profits, resulting from the estimates provided by the County. Proposer agrees to indemnify and hold the County harmless with respect to any issues, disputes, claims, lawsuits resulting from the estimates provided by the County in this solicitation, and in particular, as set forth in the Schedule of Prices. It is the responsibility of the proposer to undertake, at its sole cost, any verification of any and all information necessary for the preparation and submittal of a response to this RFP.

It is the County's sole discretion to select the collection method for each Service Area after receipt of all proposals. The County's selected collection method may not be the lowest cost collection method. The County may consider factors including but not limited to, cost per cubic yard, readiness to implement, regulatory compliance, and waste diversion potential, when deciding upon a collection method for each Service Area.

Instructions: Proposer shall enter proposed monthly rates in the blue boxes below. Proposer must submit a proposal/bid for each collection method: Three-Container, Two-Container and One-Container collection methods. Failure to do so may result in the proposal/bid being rejected as nonresponsive. All proposers should include the 14% franchise fee in their proposed rates. Proposers shall not change the numbers in Column D- Estimated No. of Collections per Week. Column E will autocalculate the Proposed Annual Amount for each service. The Proposed Total Annual Amounts for Collection Services of the County selected collection method will be used for the evaluation evaluated. Proposer is responsible for ensuring accuracy of calculations.

Additional Containers for Organic Waste

Note: The following rates apply to Residential (Single Family) Customers. These are the rates that are requested in addition to the Minimum Default Collection Service. Organic Waste rates shall be no greater than the Refuse rates. The Minimum Default Collection Service includes the equivalent of 64 gallons of weekly Organic Waste Collection Service per Customer at no additional charge.

Disposal Facility Name: GRAND CENTRAL RECYCLING AND TRANSFER Rate (Per Ton): \$105.00
Backup Disposal Facility Name: LACSD Rate (Per Ton): \$112.07

Service Description	Collection Frequency (No. of Pickups per Week)	Monthly Unit Price/Rate	(Discount Rate 3%)	Monthly Unit Price/Rate (Final Discounted Rate)	*Estimated No. of Collections per Week	Annual Amount (Discounted Monthly Unit Price/Rate x Estimated No. of Collections per Week x 12)
32-Gallon Cart	1	\$33.16	3.00%	\$32.17		\$0.00
	2	\$54.96	3.00%	\$53.31		\$0.00
	3	\$74.39	3.00%	\$72.16		\$0.00
	4	\$93.15	3.00%	\$90.36		\$0.00
	5	\$111.91	3.00%	\$108.55		\$0.00
	6	\$128.87	3.00%	\$125.00		\$0.00
	7	\$145.82	3.00%	\$141.45		\$0.00
64-Gallon Cart	1	\$37.58	3.00%	\$36.45	29	\$12,685.50
	2	\$62.29	3.00%	\$60.42		\$0.00
	3	\$84.31	3.00%	\$81.76		\$0.00
	4	\$105.56	3.00%	\$102.39		\$0.00
	5	\$126.83	3.00%	\$123.03		\$0.00
	6	\$146.05	3.00%	\$141.67		\$0.00
	7	\$165.26	3.00%	\$160.30		\$0.00
96-Gallon Cart	1	\$44.22	3.00%	\$42.89	37	\$19,044.67
	2	\$73.28	3.00%	\$71.05		\$0.00
	3	\$99.18	3.00%	\$96.20		\$0.00
	4	\$124.19	3.00%	\$120.46		\$0.00
	5	\$149.22	3.00%	\$144.74		\$0.00
	6	\$171.82	3.00%	\$166.67		\$0.00
	7	\$194.43	3.00%	\$188.60		\$0.00
1 CY Dumpster	1	\$87.19	3.00%	\$84.56	179	\$181,669.76
	2	\$149.52	3.00%	\$145.03	28	\$48,731.56
	3	\$206.70	3.00%	\$200.50	3	\$7,218.07
	4	\$262.42	3.00%	\$254.54	10	\$30,545.22
	5	\$318.14	3.00%	\$308.60		\$0.00
	6	\$369.90	3.00%	\$358.81	29	\$124,864.96
	7	\$421.67	3.00%	\$409.02		\$0.00
1.5 CY Dumpster	1	\$101.52	3.00%	\$98.48		\$0.00
	2	\$178.19	3.00%	\$172.84		\$0.00
	3	\$249.70	3.00%	\$242.21		\$0.00
	4	\$319.75	3.00%	\$310.15		\$0.00
	5	\$389.80	3.00%	\$378.11		\$0.00
	6	\$455.90	3.00%	\$442.22		\$0.00
	7	\$522.00	3.00%	\$506.34		\$0.00
2 CY Dumpster	1	\$126.66	3.00%	\$122.86		\$0.00
	2	\$253.33	3.00%	\$245.73		\$0.00
	3	\$380.00	3.00%	\$368.60		\$0.00
	4	\$434.77	3.00%	\$421.73		\$0.00
	5	\$485.95	3.00%	\$471.37		\$0.00
	6	\$553.85	3.00%	\$537.23		\$0.00
	7	\$621.76	3.00%	\$603.11		\$0.00

3 CY Dumpster	1	\$145.07	3.00%	\$140.72		\$0.00
	2	\$290.14	3.00%	\$281.44		\$0.00
	3	\$435.20	3.00%	\$422.14		\$0.00
	4	\$508.39	3.00%	\$493.14		\$0.00
	5	\$577.97	3.00%	\$560.63		\$0.00
	6	\$664.27	3.00%	\$644.34		\$0.00
	7	\$750.57	3.00%	\$728.05		\$0.00
8 CY to 40 CY Roll-offs	1	\$163.47	3.00%	\$158.57	2	\$3,805.56
	2	\$326.94	3.00%	\$317.13		\$0.00
	3	\$490.41	3.00%	\$475.70		\$0.00
	4	\$581.99	3.00%	\$564.53		\$0.00
	5	\$669.96	3.00%	\$649.86		\$0.00
	6	\$774.68	3.00%	\$751.44		\$0.00
	7	\$879.38	3.00%	\$853.00		\$0.00
Compactor	1	\$200.28	3.00%	\$194.27		\$0.00
	2	\$400.55	3.00%	\$388.53		\$0.00
	3	\$600.83	3.00%	\$582.81		\$0.00
	4	\$729.21	3.00%	\$707.33		\$0.00
	5	\$854.01	3.00%	\$828.36		\$0.00
	6	\$995.52	3.00%	\$965.65		\$0.00
	7	\$1,137.03	3.00%	\$1,102.92		\$0.00

Total Proposed Annual Amount (3C) **\$428,565.33**

Permanent Roll-Offs and Compactors: All 8, 10, 20, 30, 40 CY Roll-offs and compactors are pull rates only; total cost will be based on actual Disposal and/or Processing costs. Rates charged to Customers should include the total cost for pull, Processing and Disposal rates.

Temporary Roll-offs (Non-permanent service of no more than 30 consecutive days at Customer's site): Shall be charged as accordingly to the Service Rates indicated above and may charge an additional daily rental fee (See Extra Services Fees).

*Estimated No. of Collections per Week is based on 2019 Customer data submitted by the current non-exclusive commercial franchise waste haulers. Each of the Service Areas have different Customer counts.

Additional Entry: (Proposer may use this space to add additional information such as additional facilities and if Proposer would like to add any additional service levels and Container sizes that may have not been identified above)

TEMP ROLLOFF \$538.00 PER TON \$77.84

Exclusive Commercial Franchise Services Service Area: San Gabriel

Valley East

The undersigned Proposer offers to perform the work described in the Request for Proposals (RFP) for the following price(s). The Proposer rate(s) (hourly, monthly, etc.) shall include all administrative costs, franchise fees, labor, supervision, overtime, materials, transportation, taxes, equipment, and supplies unless stated otherwise in the RFP. The Proposer understands and agrees that the quantities set forth in the Schedule of Prices by the County are only estimates are based on current hauler submittals. Any unit prices quoted by the Proposer in this Schedule of Prices will apply to the actual quantities of work. The Proposer may use the estimates to develop its cost and rate proposal. The Proposer understands and agrees that each of the Service Areas have different Customer counts. County makes no representation or warranties of any kind, expressed or implied, as to the accuracy of the information set forth in the Schedule of Prices. County will not be liable for any damages or loss of any nature, including, but not limited to, lost profits, resulting from the estimates provided by the County. Proposer agrees to indemnify and hold the County harmless with respect to any issues, disputes, claims, lawsuits resulting from the estimates provided by the County in this solicitation, and in particular, as set forth in the Schedule of Prices. It is the responsibility of the proposer to undertake, at its sole cost, any verification of any and all information necessary for the preparation and submittal of a response to this RFP.

Instructions: Proposer shall enter a proposed rate in the blue box below. Failure to do so may result in the proposal/bid being rejected as nonresponsive.

Single Pass Collection

Note: These rates would apply to Commercial, Multifamily and Residential Customers who have been approved to receive Single-pass Collection Service. Single-Pass means that Customers may commingle and discard Refuse, Recyclables, and Organic Waste into one Collection Container, this service is subject to Director approval. Processing Facility Name: SOUTH GATE Rate (Tip Fee Per Ton): \$105

If Proposer does not currently have a facility to process Single-Pass Collection Service, Proposer shall input rates utilizing the facility tipping fee of a potential development of a High Diversion Organic Waste Processing Facility (HDOWPF) located in South Gate which will process Mixed Waste (Refuse and Organic Waste) at \$105 per ton, – OR – another High Diversion Organic Waste Processing Facility of Proposer's choosing with a reasonably similar tipping fee, location, and diversion rate that is in compliance with SB 1383 regulations as defined in 14 CCR Section 18982(a)(33).

Type of Service	Service Description	Rate
Single Pass Collection	*See Item M of Section 4 Based on Director approval	$\frac{\$ \text{ Tip Fee (Per Ton)} \times \text{Total Single-Pass Tonnage Collected}}{\text{Disposal/Diversion Expense}}$
		\$4.00 Transportation/Labor Expense (Cost per mile)

Additional Entry: (Proposer may use this space to add additional information)

The undersigned Proposer offers to perform the work described in the Request for Proposals (RFP) for the following price(s). The Proposer rate(s) (hourly, monthly, etc.) shall include all administrative costs, franchise fees, labor, supervision, overtime, materials, transportation, taxes, equipment, and supplies unless stated otherwise in the RFP. The Proposer understands and agrees that the quantities set forth in the Schedule of Prices by the County are only estimates and are based on current hauler submittals. Any unit prices quoted by the Proposer in this Schedule of Prices will apply to the actual quantities of work. The Proposer may use the estimates to develop its cost and rate proposal. The Proposer understands and agrees that each of the Service Areas have different Customer counts. County makes no representation or warranties of any kind, expressed or implied, as to the accuracy of the information set forth in the Schedule of Prices. County will not be liable for any damages or loss of any nature, including, but not limited to, lost profits, resulting from the estimates provided by the County. Proposer agrees to indemnify and hold the County harmless with respect to any issues, disputes, claims, lawsuits resulting from the estimates provided by the County in this solicitation, and in particular, as set forth in the Schedule of Prices. It is the responsibility of the proposer to undertake, at its sole cost, any verification of any and all information necessary for the preparation and submittal of a response to this RFP.

Instructions: Proposer shall enter proposed rates for extra services to Customers in the blue boxes. Failure to do so may result in the proposal/bid being rejected as nonresponsive.

Extra Services Fees

Note: These rates apply to Commercial, Multifamily and Residential Customers.

Extra Service	Description	Fee
Locks		
Padlock	Upon Customer Request	\$11.50 (one-time, per Container)
Gravity Lock	Upon Customer Request	\$15.00 (one-time, per Container)
Lock Bar	Upon Customer Request	\$15.00 (one-time, per Container)
Service		
*Roll-out	Upon Customer Request	\$5 Cost per Collection Event \$3 Cost per container (beyond first container)
*Scout	25-50 ft	\$14 Cost per Collection Event \$7 Cost per container (beyond first container)
	51-75 ft	\$14 Cost per Collection Event \$7 Cost per container (beyond first container)
	76+ ft	\$14 Cost per Collection Event \$7 Cost per container (beyond first container)
*Difficult to Service	*See Difficult to Service Areas in item L of Exhibit 3A1 (If applicable to Service Area)	\$11 Cost per Collection Event \$8 Cost per container (beyond first container)
Additional Bulky Item pickups for Multifamily and Residential Customers (After exceeding maximum Collections allowed per yr.)	*See Bulky Item Collection in item F1c of Exhibit 3A1	\$25.00 per pickup
Additional Bulky Item pickups for Commercial Customers (After exceeding 6 collections per yr.)	*See Bulky Item Collection in item F3a of Exhibit 3A1	\$25.00 per pickup

Containers		
Bear Resistant Containers -96-Gallon Cart	Upon Customer Request	\$50.00 per month
Bear Resistant Containers -Other Container size (If available):	Upon Customer Request	\$50.00 per month
Cleaning or Exchange of Containers for cleaning purposes	*See Container Cleanings in item C4 of Exhibit 3A1 (After one free cleaning per year)	\$50.00 per Cart or Dumpster Container
		\$50.00 per Compactor Container
		\$50.00 per Roll-off Container
Extra Pickup Charge, beyond 1 per year (Unscheduled collection due to non- collection events)	*See Non-Collection in item A5 of Exhibit 3A1	\$65.00 per occurrence
Container Violation Fee-For Unresponsive Customers or not rectified scenarios needing to collect Solid Waste materials subject to non-collection events	*See Non-Collection in item A5 of Exhibit 3A1	\$50.00 Per occurrence
Contamination Fee	*See Contamination Monitoring in item J1 of Exhibit 3A1	\$50.00 Per occurrence
Roll-off (Excluding C&D)	Temporary Roll-off Daily Rental Fee	\$8 per day
Container Size Exchange, beyond 1 per year	*See item C7c in Exhibit 3A1 (Each additional exchange/delivery)	\$75.00 Per each additional exchange
Container Removal and Return within previous 12 months (Containers in Public- Right-of Way)	*See Removal of Carts or Dumpsters Stored in the Public Right-of-Way in Item C7d of Exhibit 3A1	\$75.00 First removal and return (per set) \$ <u>Additional 25% fee</u> Each additional removal and return (per set) \$75.00 Cleanup of Set-Out Site
Construction and Demolition (C&D) Debris Roll-offs		
C&D Roll-off Containers	Upon Customer Request	\$ <u>Negotiate rate with Customer</u> per month
Manure Service		
64-Gallon Cart	Upon Customer Request	\$50.00 per month
1 CY Dumpster	Upon Customer Request	\$175.00 per month
2 CY Dumpster	Upon Customer Request	\$275.00 per month
In-Home Food Waste Container		
Additional in-home Food Waste Containers	*See item A3a of Exhibit 3A1 Upon Customer Request	\$15.00 per Container
Green Waste Service		
Green Waste only Containers (Carts and Dumpsters)	Upon Customer Request	\$ <u>Negotiate rate with Customer</u> per month
Billing		
Late Payment Fee	*See Section 7- Service Rates and Billing	10% of past due amount
Service Interruption	*See Section 7- Service Rates and Billing	\$25.00
Returned Checks	*See Section 7- Service Rates and Billing	\$25.00
*The cost per collection event shall include the first container and the cost per container is for each additional container beyond the first		
Additional Entry: (Proposer may use this space to add additional information)		

The undersigned Proposer offers to perform the work described in the Request for Proposals (RFP) for the following price(s). The Proposer rate(s) (hourly, monthly, etc.) shall include all administrative costs, franchise fees, labor, supervision, overtime, materials, transportation, taxes, equipment, and supplies unless stated otherwise in the RFP. The Proposer understands and agrees that the quantities set forth in the Schedule of Prices by the County are only estimates are based on current hauler submittals. Any unit prices quoted by the Proposer in this Schedule of Prices will apply to the actual quantities of work. The Proposer may use the estimates to develop its cost and rate proposal. The Proposer understands and agrees that each of the Service Areas have different Customer counts. County makes no representation or warranties of any kind, expressed or implied, as to the accuracy of the information set forth in the Schedule of Prices. County will not be liable for any damages or loss of any nature, including, but not limited to, lost profits, resulting from the estimates provided by the County. Proposer agrees to indemnify and hold the County harmless with respect to any issues, disputes, claims, lawsuits resulting from the estimates provided by the County in this solicitation, and in particular, as set forth in the Schedule of Prices. It is the responsibility of the proposer to undertake, at its sole cost, any verification of any and all information necessary for the preparation and submittal of a response to this RFP.

Instructions: Proposer shall enter proposed rates in the blue boxes below. Failure to do so may result in the proposal/bid being rejected as nonresponsive.

Unlimited Bulky Item Collections for Multifamily and Residential Customers
 The default Bulky Item Collection Services will be Option A- Maximum Amount of Collections Per Year (Tiered Approach)
 *See Section F1c of Exhibit 3A1

Added cost to Solid Waste Collection Services Base Rate to implement unlimited Bulky Item Collection Services	\$8.87
---	--------

Community Meetings

Description of Service	Rate Information	Hourly Rate
Costs for Attending/Presenting at Community Meetings	Per event	NO CHARGE

Additional Entry: *(Proposer may use this space to add additional information)*

Services

Service Area: **San Gabriel Valley East**

Rates Summary

Note: The Total Proposed Annual Amounts from all the proposal rate sheets for Collection Services only (Solid Waste Collection Services, Additional Organics and Additional Recycling rates) will be automatically calculated into the table below. Proposer is responsible for ensuring accuracy of calculations. Proposer must fill and sign the signature block acknowledgement below upon confirming calculations.

Title	Proposed Total Annual Amounts
Commercial Solid Waste Collection Services Rates (1A)	\$1,887,302.97
Commercial Additional Recycling Rates (1B)	\$1,175,153.97
Commercial Additional Organics Rates (1C)	\$1,429,457.42
Commercial Collection Services (1) (Total Proposed Annual Amounts of 1A+1B+1C)	\$4,491,914.35
Multifamily Solid Waste Collection Services Rates (2A)	\$924,512.94
Multifamily Additional Recycling Rates (2B)	\$420,337.22
Multifamily Additional Organics Rates (2C)	\$553,261.35
Multifamily Collection Services (2) (Total Proposed Annual Amounts of 2A+2B+2C)	\$1,898,111.50
Residential Solid Waste Collection Services Rates (3A)	\$795,714.59
Residential Additional Recycling Rates (3B)	\$271,681.09
Residential Additional Organics Rates (3C)	\$428,565.33
Residential Collection Services (3) (Total Proposed Annual Amounts of 3A+3B+3C)	\$1,495,961.01
Total Proposed Annual Amount for Three-Container Collection Services (Total Proposed Annual Amounts of 1+2+3)	\$7,885,986.87

Signature Block Acknowledgement:

Legal Name of Proposer - VALLEY VISTA SERVICES, INC.

Signature of Person Authorized to Submit Proposal

Title of Authorized Person - SECRETARY

Date 6-1-2022

State Contractor's License Number

Proposer's Address: 17445 EAST RAILROAD STREET CITY OF INDUSTRY CA 91748

E-Mail - DAVIDPEREZ@ZEREPMANAGEMENT.COM

Phone - 626-855-5555

Mobile

The undersigned Proposer offers to perform the work described in the Request for Proposals (RFP) for the following price(s). The Proposer rate(s) (hourly, monthly, etc.) shall include all administrative costs, franchise fees, labor, supervision, overtime, materials, transportation, taxes, equipment, and supplies unless stated otherwise in the RFP. The Proposer understands and agrees that the quantities set forth in the Schedule of Prices by the County are only estimates are based on current hauler submittals. Any unit prices quoted by the Proposer in this Schedule of Prices will apply to the actual quantities of work. The Proposer may use the estimates to develop its cost and rate proposal. The Proposer understands and agrees that each of the Service Areas have different Customer counts. County makes no representation or warranties of any kind, expressed or implied, as to the accuracy of the information set forth in the Schedule of Prices. County will not be liable for any damages or loss of any nature, including, but not limited to, lost profits, resulting from the estimates provided by the County. Proposer agrees to indemnify and hold the County harmless with respect to any issues, disputes, claims, lawsuits resulting from the estimates provided by the County in this solicitation, and in particular, as set forth in the Schedule of Prices. It is the responsibility of the proposer to undertake, at its sole cost, any verification of any and all information necessary for the preparation and submittal of a response to this RFP.

It is the County's sole discretion to select the collection method for each Service Area after receipt of all proposals. The County's selected collection method may not be the lowest cost collection method. The County may consider factors including but not limited to, cost per cubic yard, readiness to implement, regulatory compliance, and waste diversion potential, when deciding upon a collection method for each Service Area.

Instructions: Proposer shall enter proposed monthly rates in the blue boxes below. Proposer must submit a proposal/bid for each collection method: Three-Container, Two-Container and One-Container collection methods. Failure to do so may result in the proposal/bid being rejected as nonresponsive. All proposers should include the 14% franchise fee in their proposed rates. Proposers shall not change the numbers in Column D- Estimated No. of Collections per Week. Column E will auto calculate the Proposed Annual Amount for each service. The Proposed Total Annual Amounts for Collection Services of the County selected collection method will be used for the evaluation evaluated. Proposer is responsible for ensuring accuracy of calculations.

If Proposer does not currently offer the One-Container and Two-Container collection methods, Proposer shall input rates utilizing the facility tipping fee of a potential development of a High Diversion Organic Waste Processing Facility (HDOWPF) located in South Gate which will process Mixed Waste (Refuse and Organic Waste) at \$105 per ton, – OR – another High Diversion Organic Waste Processing Facility of Proposer's choosing with a reasonably similar tipping fee, location, and diversion rate that is in compliance with SB 1383 regulations as defined in 14 CCR Section 18982(a)(33). Proposer may also include in their proposal, an option to provide One-Container or Two-Container Collection Services for select Customers so long as the Proposer's proposal indicates how the results would provide similar diversion and cost effectiveness.

Commercial Mixed Waste Processing Collection Services (Two-Container A- Gray & Blue Containers)

Gray Container: Allows for the collection of Organic Waste, such as food waste and yard waste, and Refuse.

Blue Container: Limited to traditional Non-Organic Recyclables, such as bottles, and cans, and Organic Waste, such as paper and cardboard.

Note: The following rates apply to Commercial Customers for collecting Refuse and Organic Waste in the **gray container**.

Processing Facility Name: SOUTH GATE
 Processing Material(s): ORG YARD REFUSE Rate (Per Ton) 105

Service Description	Collection Frequency (No. of Pickups per Week)	Monthly Unit Price/Rate	(Discount Rate 3%)	Monthly Unit Price/Rate (Final Discounted Rate)	*Estimated No. of Collections per Week	Annual Amount (Discounted Monthly Unit Price/Rate x Estimated No. of Collections per Week x 12)
32-Gallon Cart	1	\$24.11	3.00%	\$23.38		\$0.00
	2	\$48.21	3.00%	\$46.77		\$0.00
	3	\$72.32	3.00%	\$70.15		\$0.00
	4	\$81.75	3.00%	\$79.30		\$0.00
	5	\$90.45	3.00%	\$87.74		\$0.00
	6	\$102.56	3.00%	\$99.48		\$0.00
	7	\$114.67	3.00%	\$111.23		\$0.00
64-Gallon Cart	1	\$48.21	3.00%	\$46.77		\$0.00
	2	\$96.43	3.00%	\$93.53		\$0.00
	3	\$144.64	3.00%	\$140.31		\$0.00
	4	\$163.51	3.00%	\$158.60		\$0.00
	5	\$180.90	3.00%	\$175.47		\$0.00
	6	\$205.12	3.00%	\$198.97		\$0.00
	7	\$229.34	3.00%	\$222.46		\$0.00
96-Gallon Cart	1	\$72.32	3.00%	\$70.15	1	\$841.81
	2	\$144.64	3.00%	\$140.30	1	\$1,683.62
	3	\$216.97	3.00%	\$210.46	1	\$2,525.49
	4	\$245.26	3.00%	\$237.90		\$0.00
	5	\$271.35	3.00%	\$263.21		\$0.00
	6	\$307.68	3.00%	\$298.45		\$0.00
	7	\$344.01	3.00%	\$333.69		\$0.00
1 CY Dumpster	1	\$152.16	3.00%	\$147.59	11	\$19,481.93
	2	\$304.31	3.00%	\$295.18		\$0.00
	3	\$456.48	3.00%	\$442.78		\$0.00
	4	\$516.00	3.00%	\$500.52		\$0.00
	5	\$570.90	3.00%	\$553.77		\$0.00
	6	\$647.33	3.00%	\$627.91		\$0.00
	7	\$723.76	3.00%	\$702.05		\$0.00

1.5 CY Dumpster	1	\$170.35	3.00%	\$165.23	27	\$53,536.05
	2	\$340.69	3.00%	\$330.47		\$0.00
	3	\$511.03	3.00%	\$495.69		\$0.00
	4	\$588.74	3.00%	\$571.08		\$0.00
	5	\$661.83	3.00%	\$641.97		\$0.00
	6	\$756.45	3.00%	\$733.76		\$0.00
	7	\$851.07	3.00%	\$825.54		\$0.00
2 CY Dumpster	1	\$188.53	3.00%	\$182.87	121	\$265,526.24
	2	\$377.06	3.00%	\$365.75	7	\$30,722.86
	3	\$565.59	3.00%	\$548.62	1	\$6,583.41
	4	\$661.49	3.00%	\$641.65		\$0.00
	5	\$752.76	3.00%	\$730.18		\$0.00
	6	\$865.56	3.00%	\$839.59		\$0.00
	7	\$978.36	3.00%	\$949.01		\$0.00
3 CY Dumpster	1	\$224.91	3.00%	\$218.16	296	\$774,896.90
	2	\$449.80	3.00%	\$436.31	152	\$795,822.36
	3	\$674.71	3.00%	\$654.46	107	\$840,331.81
	4	\$806.97	3.00%	\$782.76	11	\$103,324.72
	5	\$934.62	3.00%	\$906.58	30	\$326,368.54
	6	\$1,083.80	3.00%	\$1,051.29	15	\$189,231.38
	7	\$1,232.98	3.00%	\$1,195.99		\$0.00
4 CY Dumpster	1	\$261.28	3.00%	\$253.44	32	\$97,319.74
	2	\$522.55	3.00%	\$506.87	21	\$127,732.15
	3	\$783.82	3.00%	\$760.30	21	\$191,595.78
	4	\$952.46	3.00%	\$923.89	2	\$22,173.32
	5	\$1,116.48	3.00%	\$1,082.98		\$0.00
	6	\$1,302.03	3.00%	\$1,262.97	3	\$45,466.87
	7	\$1,487.58	3.00%	\$1,442.95		\$0.00
6 CY Dumpster	1	\$334.02	3.00%	\$323.99	9	\$34,991.42
	2	\$668.03	3.00%	\$647.99	1	\$7,775.87
	3	\$1,002.06	3.00%	\$971.99	4	\$46,655.69
	4	\$1,243.44	3.00%	\$1,206.14		\$0.00
	5	\$1,480.20	3.00%	\$1,435.79	4	\$68,918.01
	6	\$1,738.49	3.00%	\$1,686.33	1	\$20,236.02
	7	\$1,996.78	3.00%	\$1,936.88		\$0.00
8 CY to 40 CY Roll-offs	1	\$220.00	3.00%	\$213.40	72	\$184,377.60
	2	\$440.00	3.00%	\$426.80	1	\$5,121.60
	3	\$660.00	3.00%	\$640.20		\$0.00
	4	\$880.00	3.00%	\$853.60		\$0.00
	5	\$1,100.00	3.00%	\$1,067.00		\$0.00
	6	\$1,320.00	3.00%	\$1,280.40		\$0.00
	7	\$1,540.00	3.00%	\$1,493.80		\$0.00
Compactor	1	\$250.00	3.00%	\$242.50		\$0.00
	2	\$500.00	3.00%	\$485.00		\$0.00
	3	\$750.00	3.00%	\$727.50		\$0.00
	4	\$1,000.00	3.00%	\$970.00		\$0.00
	5	\$1,250.00	3.00%	\$1,212.50		\$0.00
	6	\$1,500.00	3.00%	\$1,455.00		\$0.00
	7	\$1,750.00	3.00%	\$1,697.50		\$0.00
Total Proposed Annual Amount (1A)						\$4,263,241.19
Permanent Roll-Offs and Compactors: All 8, 10, 20, 30, 40 CY Roll-offs and compactors are pull rates only; total cost will be based on actual Disposal and/or Processing costs. Rates charged to Customers should include the total cost for pull, Processing and Disposal rates. Temporary Roll-offs (Non-permanent service of no more than 30 consecutive days at Customer's site): Shall be charged as accordingly to the Service Rates indicated above and may charge an additional daily rental fee (See Extra Services Fees).						

*Estimated No. of Collections per Week is based on 2019 Customer data submitted by the current non-exclusive commercial franchise waste haulers. Each of the Service Areas have different Customer counts.

Additional Entry: (Proposer may use this space to add additional information such as additional facilities and if Proposer would like to add any additional service levels and Container sizes that may have not been identified above)

The undersigned Proposer offers to perform the work described in the Request for Proposals (RFP) for the following price(s). The Proposer rate(s) (hourly, monthly, etc.) shall include all administrative costs, franchise fees, labor, supervision, overtime, materials, transportation, taxes, equipment, and supplies unless stated otherwise in the RFP. The Proposer understands and agrees that the quantities set forth in the Schedule of Prices by the County are only estimates are based on current hauler submittals. Any unit prices quoted by the Proposer in this Schedule of Prices will apply to the actual quantities of work. The Proposer may use the estimates to develop its cost and rate proposal. The Proposer understands and agrees that each of the Service Areas have different Customer counts. County makes no representation or warranties of any kind, expressed or implied, as to the accuracy of the information set forth in the Schedule of Prices. County will not be liable for any damages or loss of any nature, including, but not limited to, lost profits, resulting from the estimates provided by the County. Proposer agrees to indemnify and hold the County harmless with respect to any issues, disputes, claims, lawsuits resulting from the estimates provided by the County in this solicitation, and in particular, as set forth in the Schedule of Prices. It is the responsibility of the proposer to undertake, at its sole cost, any verification of any and all information necessary for the preparation and submittal of a response to this RFP.

It is the County's sole discretion to select the collection method for each Service Area after receipt of all proposals. The County's selected collection method may not be the lowest cost collection method. The County may consider factors including but not limited to, cost per cubic yard, readiness to implement, regulatory compliance, and waste diversion potential, when deciding upon a collection method for each Service Area.

Instructions: Proposer shall enter proposed monthly rates in the blue boxes below. Proposer must submit a proposal/bid for each collection method: Three-Container, Two-Container and One-Container collection methods. Failure to do so may result in the proposal/bid being rejected as nonresponsive. All proposers should include the 14% franchise fee in their proposed rates. Proposers shall not change the numbers in Column D - Estimated No. of Collections per Week. Column E will auto calculate the Proposed Annual Amount for each service. The Proposed Total Annual Amounts for Collection Services of the County selected collection method will be used for the evaluation evaluated. Proposer is responsible for ensuring accuracy of calculations.

If Proposer does not currently offer the One-Container and Two-Container collection methods, Proposer shall input rates utilizing the facility tipping fee of a potential development of a High Diversion Organic Waste Processing Facility (HDOWPF) located in South Gate which will process Mixed Waste (Refuse and Organic Waste) at \$105 per ton, - OR - another High Diversion Organic Waste Processing Facility of Proposer's choosing with a reasonably similar tipping fee, location, and diversion rate that is in compliance with SB 1383 regulations as defined in 14 CCR Section 18982(a)(33). Proposer may also include in their proposal, an option to provide One-Container or Two-Container Collection Services for select Customers so long as the Proposer's proposal indicates how the results would provide similar diversion and cost effectiveness.

Commercial Mixed Waste Processing Collection Services (Two-Container A- Gray & Blue Containers)

Gray Container: Allows for the collection of Organic Waste, such as food waste and yard waste, and Refuse.

Blue Container: Limited to traditional Non-Organic Recyclables, such as bottles, and cans, and Organic Waste, such as paper and cardboard.

Note: The following rates apply to Commercial Customers for collecting Recyclables in the **blue container**.

Processing Facility Name: GRAND CENTRAL
 Processing Material(s): RECY Rate (Per Ton) 50

Service Description	Collection Frequency (No. of Pickups per Week)	Monthly Unit Price/Rate	(Discount Rate 3%)	Monthly Unit Price/Rate (Final Discounted Rate)	*Estimated No. of Collections per Week	Annual Amount (Discounted Monthly Unit Price/Rate x Estimated No. of Collections per Week x 12)
32-Gallon Cart	1	\$20.86	3.00%	\$20.23		\$0.00
	2	\$50.46	3.00%	\$48.95		\$0.00
	3	\$58.95	3.00%	\$57.18		\$0.00
	4	\$66.04	3.00%	\$64.06		\$0.00
	5	\$73.14	3.00%	\$70.95		\$0.00
	6	\$76.47	3.00%	\$74.18		\$0.00
	7	\$79.80	3.00%	\$77.41		\$0.00
64-Gallon Cart	1	\$21.72	3.00%	\$21.07	1	\$252.82
	2	\$52.18	3.00%	\$50.61	1	\$607.38
	3	\$61.52	3.00%	\$59.67	1	\$716.09
	4	\$69.47	3.00%	\$67.39		\$0.00
	5	\$77.42	3.00%	\$75.10		\$0.00
	6	\$81.62	3.00%	\$79.17		\$0.00
	7	\$85.82	3.00%	\$83.25		\$0.00
96-Gallon Cart	1	\$22.57	3.00%	\$21.89	11	\$2,889.86
	2	\$63.27	3.00%	\$61.37		\$0.00
	3	\$78.16	3.00%	\$75.82		\$0.00
	4	\$91.66	3.00%	\$88.91		\$0.00
	5	\$105.15	3.00%	\$102.00		\$0.00
	6	\$114.89	3.00%	\$111.44		\$0.00
	7	\$124.63	3.00%	\$120.89		\$0.00

1 CY Dumpster	1	\$80.98	3.00%	\$78.55	148	\$139,500.80
	2	\$161.96	3.00%	\$157.11	7	\$13,196.84
	3	\$242.94	3.00%	\$235.65	1	\$2,827.84
	4	\$263.46	3.00%	\$255.56		\$0.00
	5	\$280.97	3.00%	\$272.54		\$0.00
	6	\$296.06	3.00%	\$287.18		\$0.00
	7	\$311.15	3.00%	\$301.82		\$0.00
1.5 CY Dumpster	1	\$83.69	3.00%	\$81.18	296	\$288,338.75
	2	\$167.37	3.00%	\$162.35	152	\$296,131.69
	3	\$251.06	3.00%	\$243.53	107	\$312,691.68
	4	\$274.29	3.00%	\$266.07	11	\$35,120.68
	5	\$294.50	3.00%	\$285.66	30	\$102,837.77
	6	\$312.29	3.00%	\$302.92	15	\$54,525.47
	7	\$330.08	3.00%	\$320.18		\$0.00
2 CY Dumpster	1	\$86.40	3.00%	\$83.81	32	\$32,181.18
	2	\$172.78	3.00%	\$167.60	21	\$42,235.35
	3	\$259.18	3.00%	\$251.41	21	\$63,354.25
	4	\$285.11	3.00%	\$276.56	2	\$6,637.47
	5	\$308.04	3.00%	\$298.79		\$0.00
	6	\$328.53	3.00%	\$318.67	3	\$11,472.19
	7	\$349.02	3.00%	\$338.55		\$0.00
3 CY Dumpster	1	\$91.81	3.00%	\$89.05	9	\$9,617.71
	2	\$183.61	3.00%	\$178.11	1	\$2,137.27
	3	\$275.41	3.00%	\$267.15	4	\$12,823.14
	4	\$306.76	3.00%	\$297.56		\$0.00
	5	\$335.10	3.00%	\$325.04	4	\$15,602.04
	6	\$361.01	3.00%	\$350.18	1	\$4,202.13
	7	\$386.92	3.00%	\$375.31		\$0.00
4 CY Dumpster	1	\$97.22	3.00%	\$94.30		\$0.00
	2	\$194.43	3.00%	\$188.60		\$0.00
	3	\$291.65	3.00%	\$282.90		\$0.00
	4	\$328.41	3.00%	\$318.56		\$0.00
	5	\$362.16	3.00%	\$351.29		\$0.00
	6	\$393.48	3.00%	\$381.67		\$0.00
	7	\$424.80	3.00%	\$412.06		\$0.00
6 CY Dumpster	1	\$108.05	3.00%	\$104.81		\$0.00
	2	\$216.08	3.00%	\$209.60		\$0.00
	3	\$324.13	3.00%	\$314.41		\$0.00
	4	\$371.71	3.00%	\$360.56		\$0.00
	5	\$416.29	3.00%	\$403.80		\$0.00
	6	\$458.43	3.00%	\$444.68		\$0.00
	7	\$500.57	3.00%	\$485.55		\$0.00
8 CY to 40 CY Roll-offs	1	\$220.00	3.00%	\$213.40	72	\$184,377.60
	2	\$440.00	3.00%	\$426.80	1	\$5,121.60
	3	\$660.00	3.00%	\$640.20		\$0.00
	4	\$880.00	3.00%	\$853.60		\$0.00
	5	\$1,100.00	3.00%	\$1,067.00		\$0.00
	6	\$1,320.00	3.00%	\$1,280.40		\$0.00
	7	\$1,540.00	3.00%	\$1,493.80		\$0.00
Compactor	1	\$250.00	3.00%	\$242.50		\$0.00
	2	\$500.00	3.00%	\$485.00		\$0.00
	3	\$750.00	3.00%	\$727.50		\$0.00
	4	\$1,000.00	3.00%	\$970.00		\$0.00
	5	\$1,250.00	3.00%	\$1,212.50		\$0.00
	6	\$1,500.00	3.00%	\$1,455.00		\$0.00
	7	\$1,750.00	3.00%	\$1,697.50		\$0.00
Total Proposed Annual Amount (1B)						\$1,639,399.59
Permanent Roll-Offs and Compactors: All 8, 10, 20, 30, 40 CY Roll-offs and compactors are pull rates only; total cost will be based on actual Disposal and/or Processing costs. Rates charged to Customers should include the total cost for pull, Processing and Disposal rates.						
Temporary Roll-offs (Non-permanent service of no more than 30 consecutive days at Customer's site): Shall be charged as accordingly to the Service Rates indicated above and may charge an additional daily rental fee (See Extra Services Fees).						

*Estimated No. of Collections per Week is based on 2019 Customer data submitted by the current non-exclusive commercial franchise waste haulers. Each of the Service Areas have different Customer counts.

Additional Entry: (Proposer may use this space to add additional information such as additional facilities and if Proposer would like to add any additional service levels and Container sizes that may have not been identified above)

The undersigned Proposer offers to perform the work described in the Request for Proposals (RFP) for the following price(s). The Proposer rate(s) (hourly, monthly, etc.) shall include all administrative costs, franchise fees, labor, supervision, overtime, materials, transportation, taxes, equipment, and supplies unless stated otherwise in the RFP. The Proposer understands and agrees that the quantities set forth in the Schedule of Prices by the County are only estimates are based on current hauler submittals. Any unit prices quoted by the Proposer in this Schedule of Prices will apply to the actual quantities of work. The Proposer may use the estimates to develop its cost and rate proposal. The Proposer understands and agrees that each of the Service Areas have different Customer counts. County makes no representation or warranties of any kind, expressed or implied, as to the accuracy of the information set forth in the Schedule of Prices. County will not be liable for any damages or loss of any nature, including, but not limited to, lost profits, resulting from the estimates provided by the County. Proposer agrees to indemnify and hold the County harmless with respect to any issues, disputes, claims, lawsuits resulting from the estimates provided by the County in this solicitation, and in particular, as set forth in the Schedule of Prices. It is the responsibility of the proposer to undertake, at its sole cost, any verification of any and all information necessary for the preparation and submittal of a response to this RFP.

It is the County's sole discretion to select the collection method for each Service Area after receipt of all proposals. The County's selected collection method may not be the lowest cost collection method. The County may consider factors including but not limited to, cost per cubic yard, readiness to implement, regulatory compliance, and waste diversion potential, when deciding upon a collection method for each Service Area.

Instructions: Proposer shall enter proposed monthly rates in the blue boxes below. Proposer must submit a proposal/bid for each collection method: Three-Container, Two-Container and One-Container collection methods. Failure to do so may result in the proposal/bid being rejected as nonresponsive. All proposers should include the 14% franchise fee in their proposed rates. Proposers shall not change the numbers in Column D- Estimated No. of Collections per Week. Column E will auto calculate the Proposed Annual Amount for each service. The Proposed Total Annual Amounts for Collection Services of the County selected collection method will be used for the evaluation evaluated. Proposer is responsible for ensuring accuracy of calculations.

If Proposer does not currently offer the One-Container and Two-Container collection methods, Proposer shall input rates utilizing the facility tipping fee of a potential development of a High Diversion Organic Waste Processing Facility (HDOWPF) located in South Gate which will process Mixed Waste (Refuse and Organic Waste) at \$105 per ton, – OR – another High Diversion Organic Waste Processing Facility of Proposer's choosing with a reasonably similar tipping fee, location, and diversion rate that is in compliance with SB 1383 regulations as defined in 14 CCR Section 18982(a)(33). Proposer may also include in their proposal, an option to provide One-Container or Two-Container Collection Services for select Customers so long as the Proposer's proposal indicates how the results would provide similar diversion and cost effectiveness.

Commercial Mixed Waste Processing Collection Services (Two-Container B- Gray & Green Containers)

Gray Container: Allows for the collection of intentional commingled wastes including Organic Waste (paper, cardboard) and Non-Organic Recyclables (bottles and cans), and Refuse.

Green Container: Limited to only Organic Waste sent to a source separated organics facility. This includes food waste and yard waste.

Note: The following rates apply to Commercial Customers for collecting all commingled wastes & Non-Organic Recyclables in the **gray container**.

Processing Facility Name: **GRAND CENTRAL RECYCLING AND TRANSFER**

Processing Material(s): **MSW/REC Rate (Per Ton) \$77.84**

Service Description	Collection Frequency (No. of Pickups per Week)	Monthly Unit Price/Rate	(Discount Rate 3%)	Monthly Unit Price/Rate (Final Discounted Rate)	*Estimated No. of Collections per Week	Annual Amount (Discounted Monthly Unit Price/Rate x Estimated No. of Collections per Week x 12)
32-Gallon Cart	1	\$31.58	3.00%	\$30.63		\$0.00
	2	\$52.34	3.00%	\$50.77		\$0.00
	3	\$70.85	3.00%	\$68.72		\$0.00
	4	\$88.71	3.00%	\$86.05		\$0.00
	5	\$106.58	3.00%	\$103.38		\$0.00
	6	\$122.73	3.00%	\$119.05		\$0.00
	7	\$138.88	3.00%	\$134.71		\$0.00
64-Gallon Cart	1	\$35.79	3.00%	\$34.72		\$0.00
	2	\$59.32	3.00%	\$57.54		\$0.00
	3	\$80.29	3.00%	\$77.88		\$0.00
	4	\$100.54	3.00%	\$97.52		\$0.00
	5	\$120.79	3.00%	\$117.17		\$0.00
	6	\$139.09	3.00%	\$134.92		\$0.00
	7	\$157.39	3.00%	\$152.67		\$0.00
96-Gallon Cart	1	\$42.11	3.00%	\$40.85	1	\$490.16
	2	\$69.79	3.00%	\$67.70	1	\$812.36
	3	\$94.46	3.00%	\$91.63	1	\$1,099.51
	4	\$118.28	3.00%	\$114.73		\$0.00
	5	\$142.11	3.00%	\$137.85		\$0.00
	6	\$163.64	3.00%	\$158.73		\$0.00
	7	\$185.17	3.00%	\$179.61		\$0.00
1 CY Dumpster	1	\$103.11	3.00%	\$100.02	11	\$13,202.20
	2	\$206.21	3.00%	\$200.02		\$0.00
	3	\$309.32	3.00%	\$300.04		\$0.00
	4	\$343.97	3.00%	\$333.65		\$0.00
	5	\$375.18	3.00%	\$363.92		\$0.00
	6	\$422.32	3.00%	\$409.65		\$0.00
	7	\$469.46	3.00%	\$455.38		\$0.00

1.5 CY Dumpster	1	\$111.87	3.00%	\$108.51	27	\$35,158.50
	2	\$223.74	3.00%	\$217.03		\$0.00
	3	\$335.61	3.00%	\$325.54		\$0.00
	4	\$379.02	3.00%	\$367.65		\$0.00
	5	\$419.00	3.00%	\$406.43		\$0.00
	6	\$474.90	3.00%	\$460.65		\$0.00
	7	\$530.80	3.00%	\$514.88		\$0.00
2 CY Dumpster	1	\$120.63	3.00%	\$117.01	121	\$169,900.12
	2	\$241.27	3.00%	\$234.03	7	\$19,658.68
	3	\$361.90	3.00%	\$351.04	1	\$4,212.52
	4	\$414.07	3.00%	\$401.65		\$0.00
	5	\$462.81	3.00%	\$448.93		\$0.00
	6	\$527.48	3.00%	\$511.66		\$0.00
	7	\$592.15	3.00%	\$574.39		\$0.00
3 CY Dumpster	1	\$138.16	3.00%	\$134.02	296	\$476,021.99
	2	\$276.32	3.00%	\$268.03	152	\$488,887.45
	3	\$414.48	3.00%	\$402.05	107	\$516,226.55
	4	\$484.18	3.00%	\$469.65	11	\$61,994.41
	5	\$550.45	3.00%	\$533.94	30	\$192,217.14
	6	\$632.64	3.00%	\$613.66	15	\$110,458.94
	7	\$714.83	3.00%	\$693.39		\$0.00
4 CY Dumpster	1	\$155.69	3.00%	\$151.02	32	\$57,991.41
	2	\$311.37	3.00%	\$302.03	21	\$76,111.28
	3	\$467.06	3.00%	\$453.05	21	\$114,168.15
	4	\$554.28	3.00%	\$537.65	2	\$12,903.64
	5	\$638.08	3.00%	\$618.94		\$0.00
	6	\$737.79	3.00%	\$715.66	3	\$25,763.63
	7	\$837.50	3.00%	\$812.38		\$0.00
6 CY Dumpster	1	\$190.74	3.00%	\$185.02	9	\$19,981.92
	2	\$381.48	3.00%	\$370.04	1	\$4,440.43
	3	\$572.22	3.00%	\$555.05	4	\$26,642.56
	4	\$694.49	3.00%	\$673.66		\$0.00
	5	\$813.34	3.00%	\$788.94	4	\$37,869.11
	6	\$948.11	3.00%	\$919.67	1	\$11,036.00
	7	\$1,082.88	3.00%	\$1,050.39		\$0.00
8 CY to 40 CY Roll-offs	1	\$220.00	3.00%	\$213.40	72	\$184,377.60
	2	\$440.00	3.00%	\$426.80	1	\$5,121.60
	3	\$660.00	3.00%	\$640.20		\$0.00
	4	\$880.00	3.00%	\$853.60		\$0.00
	5	\$1,100.00	3.00%	\$1,067.00		\$0.00
	6	\$1,320.00	3.00%	\$1,280.40		\$0.00
	7	\$1,540.00	3.00%	\$1,493.80		\$0.00
Compactor	1	\$250.00	3.00%	\$242.50		\$0.00
	2	\$500.00	3.00%	\$485.00		\$0.00
	3	\$750.00	3.00%	\$727.50		\$0.00
	4	\$1,000.00	3.00%	\$970.00		\$0.00
	5	\$1,250.00	3.00%	\$1,212.50		\$0.00
	6	\$1,500.00	3.00%	\$1,455.00		\$0.00
	7	\$1,750.00	3.00%	\$1,697.50		\$0.00
Total Proposed Annual Amount (1C)						\$2,666,747.86

Permanent Roll-Offs and Compactors: All 8, 10, 20, 30, 40 CY Roll-offs and compactors are pull rates only; total cost will be based on actual Disposal and/or Processing costs. Rates charged to Customers should include the total cost for pull, Processing and Disposal rates.
Temporary Roll-offs (Non-permanent service of no more than 30 consecutive days at Customer's site): Shall be charged as accordingly to the Service Rates indicated above and may charge an additional daily rental fee (See Extra Services Fees).

*Estimated No. of Collections per Week is based on 2019 Customer data submitted by the current non-exclusive commercial franchise waste haulers. Each of the Service Areas have different Customer counts.

Additional Entry: (Proposer may use this space to add additional information such as additional facilities and if Proposer would like to add any additional service levels and Container sizes that may have not been identified above)
TEMP ROLLOFF \$538.00 PER TON \$77.84

The undersigned Proposer offers to perform the work described in the Request for Proposals (RFP) for the following price(s). The Proposer rate(s) (hourly, monthly, etc.) shall include all administrative costs, franchise fees, labor, supervision, overtime, materials, transportation, taxes, equipment, and supplies unless stated otherwise in the RFP. The Proposer understands and agrees that the quantities set forth in the Schedule of Prices by the County are only estimates are based on current hauler submittals. Any unit prices quoted by the Proposer in this Schedule of Prices will apply to the actual quantities of work. The Proposer may use the estimates to develop its cost and rate proposal. The Proposer understands and agrees that each of the Service Areas have different Customer counts. County makes no representation or warranties of any kind, expressed or implied, as to the accuracy of the information set forth in the Schedule of Prices. County will not be liable for any damages or loss of any nature, including, but not limited to, lost profits, resulting from the estimates provided by the County. Proposer agrees to indemnify and hold the County harmless with respect to any issues, disputes, claims, lawsuits resulting from the estimates provided by the County in this solicitation, and in particular, as set forth in the Schedule of Prices. It is the responsibility of the proposer to undertake, at its sole cost, any verification of any and all information necessary for the preparation and submittal of a response to this RFP.

It is the County's sole discretion to select the collection method for each Service Area after receipt of all proposals. The County's selected collection method may not be the lowest cost collection method. The County may consider factors including but not limited to, cost per cubic yard, readiness to implement, regulatory compliance, and waste diversion potential, when deciding upon a collection method for each Service Area.

Instructions: Proposer shall enter proposed monthly rates in the blue boxes below. Proposer must submit a proposal/bid for each collection method: Three-Container, Two-Container and One-Container collection methods. Failure to do so may result in the proposal/bid being rejected as nonresponsive. All proposers should include the 14% franchise fee in their proposed rates. Proposers shall not change the numbers in Column D- Estimated No. of Collections per Week. Column E will auto calculate the Proposed Annual Amount for each service. The Proposed Total Annual Amounts for Collection Services of the County selected collection method will be used for the evaluation evaluated. Proposer is responsible for ensuring accuracy of calculations.

If Proposer does not currently offer the One-Container and Two-Container collection methods, Proposer shall input rates utilizing the facility tipping fee of a potential development of a High Diversion Organic Waste Processing Facility (HDOWPF) located in South Gate which will process Mixed Waste (Refuse and Organic Waste) at \$105 per ton, – OR – another High Diversion Organic Waste Processing Facility of Proposer's choosing with a reasonably similar tipping fee, location, and diversion rate that is in compliance with SB 1383 regulations as defined in 14 CCR Section 18982(a)(33). Proposer may also include in their proposal, an option to provide One-Container or Two-Container Collection Services for select Customers so long as the Proposer's proposal indicates how the results would provide similar diversion and cost effectiveness.

Commercial Mixed Waste Processing Collection Services (Two-Container B- Gray & Green Containers)

Gray Container: Allows for the collection of intentional commingled wastes including Organic Waste (paper, cardboard) and Non-Organic Recyclables (bottles and cans), and Refuse.

Green Container: Limited to only Organic Waste sent to a source separated organics facility. This includes food waste and yard waste.

Note: The following rates apply to Commercial Customers for collecting Organic Waste in the **green container**.

Processing Facility Name: GRAND CENTRAL RECYCLING AND TRANSFER

Processing Material(s): ORG/YARD Rate (Per Ton) \$105.00

Service Description	Collection Frequency (No. of Pickups per Week)	Monthly Unit Price/Rate	(Discount Rate 3%)	Monthly Unit Price/Rate (Final Discounted Rate)	*Estimated No. of Collections per Week	Annual Amount (Discounted Monthly Unit Price/Rate x Estimated No. of Collections per Week x 12)
32-Gallon Cart	1	\$47.53	3.00%	\$46.11	1	\$553.26
	2	\$95.06	3.00%	\$92.21	1	\$1,106.46
	3	\$142.58	3.00%	\$138.31	1	\$1,659.66
	4	\$190.11	3.00%	\$184.40		\$0.00
	5	\$237.64	3.00%	\$230.51		\$0.00
	6	\$285.17	3.00%	\$276.61		\$0.00
	7	\$332.69	3.00%	\$322.71		\$0.00
64-Gallon Cart	1	\$53.87	3.00%	\$52.25	37	\$23,200.19
	2	\$107.73	3.00%	\$104.50		\$0.00
	3	\$161.59	3.00%	\$156.75		\$0.00
	4	\$215.46	3.00%	\$208.99		\$0.00
	5	\$269.32	3.00%	\$261.24		\$0.00
	6	\$323.19	3.00%	\$313.49		\$0.00
	7	\$377.05	3.00%	\$365.74		\$0.00
96-Gallon Cart	1	\$63.38	3.00%	\$61.47	119	\$87,784.52
	2	\$126.74	3.00%	\$122.94	6	\$8,851.70
	3	\$190.11	3.00%	\$184.41	1	\$2,212.88
	4	\$253.48	3.00%	\$245.87		\$0.00
	5	\$316.85	3.00%	\$307.35		\$0.00
	6	\$380.22	3.00%	\$368.81		\$0.00
	7	\$443.59	3.00%	\$430.28		\$0.00
1 CY Dumpster	1	\$103.77	3.00%	\$100.66	319	\$385,314.61
	2	\$207.53	3.00%	\$201.30	162	\$391,335.17
	3	\$311.30	3.00%	\$301.96	110	\$398,588.52
	4	\$346.60	3.00%	\$336.20	9	\$36,309.82
	5	\$378.48	3.00%	\$367.13	30	\$132,165.22
	6	\$426.28	3.00%	\$413.49	17	\$84,352.29
	7	\$474.08	3.00%	\$459.86		\$0.00

1.5 CY Dumpster	1	\$112.86	3.00%	\$109.47	15	\$19,705.36
	2	\$225.72	3.00%	\$218.95	4	\$10,509.52
	3	\$338.58	3.00%	\$328.42	12	\$47,292.85
	4	\$382.98	3.00%	\$371.49	4	\$17,831.55
	5	\$423.95	3.00%	\$411.23	1	\$4,934.78
	6	\$480.83	3.00%	\$466.41		\$0.00
	7	\$537.71	3.00%	\$521.58		\$0.00
2 CY Dumpster	1	\$121.95	3.00%	\$118.29	5	\$7,097.49
	2	\$243.90	3.00%	\$236.58	9	\$25,550.96
	3	\$365.86	3.00%	\$354.88	9	\$38,327.49
	4	\$419.35	3.00%	\$406.77	3	\$14,643.70
	5	\$469.41	3.00%	\$455.33		\$0.00
	6	\$535.39	3.00%	\$519.33	1	\$6,231.94
	7	\$601.37	3.00%	\$583.33		\$0.00
3 CY Dumpster	1	\$140.14	3.00%	\$135.94	1	\$1,631.23
	2	\$280.28	3.00%	\$271.87		\$0.00
	3	\$420.41	3.00%	\$407.80	1	\$4,893.57
	4	\$492.09	3.00%	\$477.33	1	\$5,727.93
	5	\$560.34	3.00%	\$543.53		\$0.00
	6	\$644.51	3.00%	\$625.17		\$0.00
	7	\$728.68	3.00%	\$706.82		\$0.00
4 CY Dumpster	1	\$158.32	3.00%	\$153.57		\$0.00
	2	\$316.65	3.00%	\$307.15		\$0.00
	3	\$474.97	3.00%	\$460.72		\$0.00
	4	\$564.84	3.00%	\$547.89		\$0.00
	5	\$651.27	3.00%	\$631.73		\$0.00
	6	\$753.62	3.00%	\$731.01		\$0.00
	7	\$855.97	3.00%	\$830.29		\$0.00
6 CY Dumpster	1	\$194.70	3.00%	\$188.86		\$0.00
	2	\$389.39	3.00%	\$377.71		\$0.00
	3	\$584.09	3.00%	\$566.57		\$0.00
	4	\$710.32	3.00%	\$689.01		\$0.00
	5	\$833.13	3.00%	\$808.14		\$0.00
	6	\$971.86	3.00%	\$942.70		\$0.00
	7	\$1,110.59	3.00%	\$1,077.27		\$0.00
8 CY to 40 CY Roll-offs	1	\$220.00	3.00%	\$213.40	72	\$184,377.60
	2	\$440.00	3.00%	\$426.80	1	\$5,121.60
	3	\$660.00	3.00%	\$640.20		\$0.00
	4	\$880.00	3.00%	\$853.60		\$0.00
	5	\$1,100.00	3.00%	\$1,067.00		\$0.00
	6	\$1,320.00	3.00%	\$1,280.40		\$0.00
	7	\$1,540.00	3.00%	\$1,493.80		\$0.00
Compactor	1	\$250.00	3.00%	\$242.50		\$0.00
	2	\$500.00	3.00%	\$485.00		\$0.00
	3	\$750.00	3.00%	\$727.50		\$0.00
	4	\$1,000.00	3.00%	\$970.00		\$0.00
	5	\$1,250.00	3.00%	\$1,212.50		\$0.00
	6	\$1,500.00	3.00%	\$1,455.00		\$0.00
	7	\$1,750.00	3.00%	\$1,697.50		\$0.00
Total Proposed Annual Amount (1D)						\$1,947,311.87

Permanent Roll-Offs and Compactors: All 8, 10, 20, 30, 40 CY Roll-offs and compactors are pull rates only; total cost will be based on actual Disposal and/or Processing costs. Rates charged to Customers should include the total cost for pull, Processing and Disposal rates.

Temporary Roll-offs (Non-permanent service of no more than 30 consecutive days at Customer's site): Shall be charged as accordingly to the Service Rates indicated above and may charge an additional daily rental fee (See Extra Services Fees).

*Estimated No. of Collections per Week is based on 2019 Customer data submitted by the current non-exclusive commercial franchise waste haulers. Each of the Service Areas have different Customer counts.

Additional Entry: (Proposer may use this space to add additional information such as additional facilities and if Proposer would like to add any additional service levels and Container sizes that may have not been identified above)
TEMP ROLLOFF \$538.00 PER TON \$77.84

The undersigned Proposer offers to perform the work described in the Request for Proposals (RFP) for the following price(s). The Proposer rate(s) (hourly, monthly, etc.) shall include all administrative costs, franchise fees, labor, supervision, overtime, materials, transportation, taxes, equipment, and supplies unless stated otherwise in the RFP. The Proposer understands and agrees that the quantities set forth in the Schedule of Prices by the County are only estimates are based on current hauler submittals. Any unit prices quoted by the Proposer in this Schedule of Prices will apply to the actual quantities of work. The Proposer may use the estimates to develop its cost and rate proposal. The Proposer understands and agrees that each of the Service Areas have different Customer counts. County makes no representation or warranties of any kind, expressed or implied, as to the accuracy of the information set forth in the Schedule of Prices. County will not be liable for any damages or loss of any nature, including, but not limited to, lost profits, resulting from the estimates provided by the County. Proposer agrees to indemnify and hold the County harmless with respect to any issues, disputes, claims, lawsuits resulting from the estimates provided by the County in this solicitation, and in particular, as set forth in the Schedule of Prices. It is the responsibility of the proposer to undertake, at its sole cost, any verification of any and all information necessary for the preparation and submittal of a response to this RFP.

It is the County's sole discretion to select the collection method for each Service Area after receipt of all proposals. The County's selected collection method may not be the lowest cost collection method. The County may consider factors including but not limited to, cost per cubic yard, readiness to implement, regulatory compliance, and waste diversion potential, when deciding upon a collection method for each Service Area.

Instructions: Proposer shall enter proposed monthly rates in the blue boxes below. Proposer must submit a proposal/bid for each collection method: Three-Container, Two-Container and One-Container collection methods. Failure to do so may result in the proposal/bid being rejected as nonresponsive. All proposers should include the 14% franchise fee in their proposed rates. Proposers shall not change the numbers in Column D- Estimated No. of Collections per Week. Column E will auto calculate the Proposed Annual Amount for each service. The Proposed Total Annual Amounts for Collection Services of the County selected collection method will be used for the evaluation evaluated. Proposer is responsible for ensuring accuracy of calculations.

If Proposer does not currently offer the One-Container and Two-Container collection methods, Proposer shall input rates utilizing the facility tipping fee of a potential development of a High Diversion Organic Waste Processing Facility (HDOWPF) located in South Gate which will process Mixed Waste (Refuse and Organic Waste) at \$105 per ton, – OR – another High Diversion Organic Waste Processing Facility of Proposer's choosing with a reasonably similar tipping fee, location, and diversion rate that is in compliance with SB 1383 regulations as defined in 14 CCR Section 18982(a)(33). Proposer may also include in their proposal, an option to provide One-Container or Two-Container Collection Services for select Customers so long as the Proposer's proposal indicates how the results would provide similar diversion and cost effectiveness.

Commercial Mixed Waste Processing Collection Services (One-Container)

Note: The following rates apply to Commercial Customers for collecting Refuse, Recycling and Organic Waste materials into a single gray container.

Processing Facility Name: SOUTH GATE

Processing Material(s): MSW/REC/ORG/YARD Rate (Per Ton) \$105.00

Service Description	Collection Frequency (No. of Pickups per Week)	Monthly Unit Price/Rate	(Discount Rate 3%)	Monthly Unit Price/Rate (Final Discounted Rate)	*Estimated No. of Collections per Week	Annual Amount (Discounted Monthly Unit Price/Rate x Estimated No. of Collections per Week x 12)
32-Gallon Cart	1	\$31.58	3.00%	\$30.63		\$0.00
	2	\$52.34	3.00%	\$50.77		\$0.00
	3	\$70.85	3.00%	\$68.72		\$0.00
	4	\$88.71	3.00%	\$86.05		\$0.00
	5	\$106.58	3.00%	\$103.38		\$0.00
	6	\$122.73	3.00%	\$119.05		\$0.00
	7	\$138.88	3.00%	\$134.71		\$0.00
64-Gallon Cart	1	\$35.79	3.00%	\$34.72		\$0.00
	2	\$59.32	3.00%	\$57.54		\$0.00
	3	\$80.29	3.00%	\$77.88		\$0.00
	4	\$100.54	3.00%	\$97.52		\$0.00
	5	\$120.79	3.00%	\$117.17		\$0.00
	6	\$139.09	3.00%	\$134.92		\$0.00
	7	\$157.39	3.00%	\$152.67		\$0.00

96-Gallon Cart	1	\$42.11	3.00%	\$40.85	1	\$490.16
	2	\$69.79	3.00%	\$67.70	1	\$812.36
	3	\$94.46	3.00%	\$91.63	1	\$1,099.51
	4	\$118.28	3.00%	\$114.73		\$0.00
	5	\$142.11	3.00%	\$137.85		\$0.00
	6	\$163.64	3.00%	\$158.73		\$0.00
	7	\$185.17	3.00%	\$179.61		\$0.00
1 CY Dumpster	1	\$109.22	3.00%	\$105.94	11	\$13,984.53
	2	\$218.44	3.00%	\$211.89		\$0.00
	3	\$327.67	3.00%	\$317.84		\$0.00
	4	\$368.43	3.00%	\$357.38		\$0.00
	5	\$405.76	3.00%	\$393.59		\$0.00
	6	\$459.01	3.00%	\$445.24		\$0.00
	7	\$512.26	3.00%	\$496.89		\$0.00
1.5 CY Dumpster	1	\$121.04	3.00%	\$117.41	27	\$38,040.45
	2	\$242.09	3.00%	\$234.83		\$0.00
	3	\$363.13	3.00%	\$352.24		\$0.00
	4	\$415.71	3.00%	\$403.24		\$0.00
	5	\$464.86	3.00%	\$450.91		\$0.00
	6	\$529.94	3.00%	\$514.04		\$0.00
	7	\$595.02	3.00%	\$577.17		\$0.00
2 CY Dumpster	1	\$132.86	3.00%	\$128.87	121	\$187,125.34
	2	\$265.73	3.00%	\$257.76	7	\$21,651.68
	3	\$398.59	3.00%	\$386.63	1	\$4,639.59
	4	\$462.99	3.00%	\$449.10		\$0.00
	5	\$523.97	3.00%	\$508.25		\$0.00
	6	\$600.86	3.00%	\$582.83		\$0.00
	7	\$677.75	3.00%	\$657.42		\$0.00
3 CY Dumpster	1	\$156.51	3.00%	\$151.81	296	\$539,245.81
	2	\$313.01	3.00%	\$303.62	152	\$553,802.33
	3	\$469.52	3.00%	\$455.43	107	\$584,777.77
	4	\$557.56	3.00%	\$540.83	11	\$71,389.98
	5	\$642.18	3.00%	\$622.91	30	\$224,249.26
	6	\$742.71	3.00%	\$720.43	15	\$129,677.17
	7	\$843.24	3.00%	\$817.94		\$0.00
4 CY Dumpster	1	\$180.15	3.00%	\$174.75	32	\$67,102.27
	2	\$360.29	3.00%	\$349.48	21	\$88,069.29
	3	\$540.44	3.00%	\$524.23	21	\$132,105.15
	4	\$652.13	3.00%	\$632.57	2	\$15,181.59
	5	\$760.39	3.00%	\$737.58		\$0.00
	6	\$884.56	3.00%	\$858.02	3	\$30,888.84
	7	\$1,008.73	3.00%	\$978.47		\$0.00
6 CY Dumpster	1	\$227.43	3.00%	\$220.61	9	\$23,825.57
	2	\$454.86	3.00%	\$441.21	1	\$5,294.57
	3	\$682.29	3.00%	\$661.82	4	\$31,767.42
	4	\$841.26	3.00%	\$816.02		\$0.00
	5	\$996.80	3.00%	\$966.90	4	\$46,411.01
	6	\$1,168.26	3.00%	\$1,133.21	1	\$13,598.55
	7	\$1,339.72	3.00%	\$1,299.53		\$0.00

8 CY to 40 CY Roll-offs	1	\$220.00	3.00%	\$213.40	72	\$184,377.60
	2	\$440.00	3.00%	\$426.80	1	\$5,121.60
	3	\$660.00	3.00%	\$640.20		\$0.00
	4	\$880.00	3.00%	\$853.60		\$0.00
	5	\$1,100.00	3.00%	\$1,067.00		\$0.00
	6	\$1,320.00	3.00%	\$1,280.40		\$0.00
	7	\$1,540.00	3.00%	\$1,493.80		\$0.00
Compactor	1	\$250.00	3.00%	\$242.50		\$0.00
	2	\$500.00	3.00%	\$485.00		\$0.00
	3	\$750.00	3.00%	\$727.50		\$0.00
	4	\$1,000.00	3.00%	\$970.00		\$0.00
	5	\$1,250.00	3.00%	\$1,212.50		\$0.00
	6	\$1,500.00	3.00%	\$1,455.00		\$0.00
	7	\$1,750.00	3.00%	\$1,697.50		\$0.00
Total Proposed Annual Amount (1E)						\$3,014,729.39
<p>Permanent Roll-Offs and Compactors: All 8, 10, 20, 30, 40 CY Roll-offs and compactors are pull rates only; total cost will be based on actual Disposal and/or Processing costs. Rates charged to Customers should include the total cost for pull, Processing and Disposal rates.</p> <p>Temporary Roll-offs (Non-permanent service of no more than 30 consecutive days at Customer's site): Shall be charged as accordingly to the Service Rates indicated above and may charge an additional daily rental fee (See Extra Services Fees).</p>						

*Estimated No. of Collections per Week is based on 2019 Customer data submitted by the current non-exclusive commercial franchise waste haulers. Each of the Service Areas have different Customer counts.

Additional Entry: (Proposer may use this space to add additional information such as additional facilities and if Proposer would like to add any additional service levels and Container sizes that may have not been identified above) **TEMP ROLLOFF \$538.00 PER TON \$77.84**

The undersigned Proposer offers to perform the work described in the Request for Proposals (RFP) for the following price(s). The Proposer rate(s) (hourly, monthly, etc.) shall include all administrative costs, franchise fees, labor, supervision, overtime, materials, transportation, taxes, equipment, and supplies unless stated otherwise in the RFP. The Proposer understands and agrees that the quantities set forth in the Schedule of Prices by the County are only estimates are based on current hauler submittals. Any unit prices quoted by the Proposer in this Schedule of Prices will apply to the actual quantities of work. The Proposer may use the estimates to develop its cost and rate proposal. The Proposer understands and agrees that each of the Service Areas have different Customer counts. County makes no representation or warranties of any kind, expressed or implied, as to the accuracy of the information set forth in the Schedule of Prices. County will not be liable for any damages or loss of any nature, including, but not limited to, lost profits, resulting from the estimates provided by the County. Proposer agrees to indemnify and hold the County harmless with respect to any issues, disputes, claims, lawsuits resulting from the estimates provided by the County in this solicitation, and in particular, as set forth in the Schedule of Prices. It is the responsibility of the proposer to undertake, at its sole cost, any verification of any and all information necessary for the preparation and submittal of a response to this RFP.

It is the County's sole discretion to select the collection method for each Service Area after receipt of all proposals. The County's selected collection method may not be the lowest cost collection method. The County may consider factors including but not limited to, cost per cubic yard, readiness to implement, regulatory compliance, and waste diversion potential, when deciding upon a collection method for each Service Area.

Instructions: Proposer shall enter proposed monthly rates in the blue boxes below. Proposer must submit a proposal/bid for each collection method: Three-Container, Two-Container and One-Container collection methods. Failure to do so may result in the proposal/bid being rejected as nonresponsive. All proposers should include the 14% franchise fee in their proposed rates. Proposers shall not change the numbers in Column D- Estimated No. of Collections per Week. Column E will auto calculate the Proposed Annual Amount for each service. The Proposed Total Annual Amounts for Collection Services of the County selected collection method will be used for the evaluation evaluated. Proposer is responsible for ensuring accuracy of calculations.

If Proposer does not currently offer the One-Container and Two-Container collection methods, Proposer shall input rates utilizing the facility tipping fee of a potential development of a High Diversion Organic Waste Processing Facility (HDOWPF) located in South Gate which will process Mixed Waste (Refuse and Organic Waste) at \$105 per ton, – OR – another High Diversion Organic Waste Processing Facility of Proposer's choosing with a reasonably similar tipping fee, location, and diversion rate that is in compliance with SB 1383 regulations as defined in 14 CCR Section 18982(a)(33). Proposer may also include in their proposal, an option to provide One-Container or Two-Container Collection Services for select Customers so long as the Proposer's proposal indicates how the results would provide similar diversion and cost effectiveness.

Multifamily Mixed Waste Processing Collection Services (Two-Container A- Gray & Blue Containers)

Gray Container: Allows for the collection of Organic Waste, such as food waste and yard waste, and Refuse.

Blue Container: Limited to traditional Non-Organic Recyclables, such as bottles, and cans, and Organic Waste, such as paper and cardboard.

Note: The following rates apply to Multifamily Customers for collecting Refuse and Organic Waste in the **gray container**.

Processing Facility Name: SOUTH GATE

Processing Material(s): ORG YARD REF Rate (Per Ton) 105

Service Description	Collection Frequency (No. of Pickups per Week)	Monthly Unit Price/Rate	(Discount Rate 3%)	Monthly Unit Price/Rate (Final Discounted Rate)	*Estimated No. of Collections per Week	Annual Amount (Discounted Monthly Unit Price/Rate x Estimated No. of Collections per Week x 12)
32-Gallon Cart	1	\$25.31	3.00%	\$24.55		\$0.00
	2	\$50.62	3.00%	\$49.11		\$0.00
	3	\$75.94	3.00%	\$73.66		\$0.00
	4	\$85.84	3.00%	\$83.27		\$0.00
	5	\$94.97	3.00%	\$92.12		\$0.00
	6	\$107.69	3.00%	\$104.46		\$0.00
	7	\$120.40	3.00%	\$116.79		\$0.00
64-Gallon Cart	1	\$50.62	3.00%	\$49.11		\$0.00
	2	\$101.25	3.00%	\$98.21		\$0.00
	3	\$151.88	3.00%	\$147.32		\$0.00
	4	\$171.68	3.00%	\$166.53		\$0.00
	5	\$189.95	3.00%	\$184.25		\$0.00
	6	\$215.38	3.00%	\$208.92		\$0.00
	7	\$240.81	3.00%	\$233.58		\$0.00

96-Gallon Cart	1	\$75.94	3.00%	\$73.66		\$0.00
	2	\$151.87	3.00%	\$147.32		\$0.00
	3	\$227.81	3.00%	\$220.98		\$0.00
	4	\$257.52	3.00%	\$249.80		\$0.00
	5	\$284.92	3.00%	\$276.37		\$0.00
	6	\$323.07	3.00%	\$313.37		\$0.00
	7	\$361.21	3.00%	\$350.37		\$0.00
1 CY Dumpster	1	\$159.76	3.00%	\$154.97	1	\$1,859.64
	2	\$319.53	3.00%	\$309.94		\$0.00
	3	\$479.30	3.00%	\$464.92		\$0.00
	4	\$541.80	3.00%	\$525.55		\$0.00
	5	\$599.44	3.00%	\$581.46		\$0.00
	6	\$679.70	3.00%	\$659.31		\$0.00
	7	\$759.95	3.00%	\$737.15		\$0.00
1.5 CY Dumpster	1	\$178.86	3.00%	\$173.50	1	\$2,081.96
	2	\$357.72	3.00%	\$346.99	1	\$4,163.91
	3	\$536.58	3.00%	\$520.48		\$0.00
	4	\$618.18	3.00%	\$599.63		\$0.00
	5	\$694.92	3.00%	\$674.07		\$0.00
	6	\$794.27	3.00%	\$770.44		\$0.00
	7	\$893.62	3.00%	\$866.82		\$0.00
2 CY Dumpster	1	\$197.95	3.00%	\$192.01	16	\$36,866.45
	2	\$395.91	3.00%	\$384.04	1	\$4,608.43
	3	\$593.86	3.00%	\$576.05	1	\$6,912.58
	4	\$694.57	3.00%	\$673.73	5	\$40,423.79
	5	\$790.40	3.00%	\$766.68		\$0.00
	6	\$908.84	3.00%	\$881.57		\$0.00
	7	\$1,027.28	3.00%	\$996.46		\$0.00
3 CY Dumpster	1	\$236.15	3.00%	\$229.07	58	\$159,429.80
	2	\$472.29	3.00%	\$458.12	55	\$302,360.14
	3	\$708.44	3.00%	\$687.19	64	\$527,759.79
	4	\$847.32	3.00%	\$821.90	11	\$108,490.96
	5	\$981.35	3.00%	\$951.91		\$0.00
	6	\$1,137.99	3.00%	\$1,103.85	3	\$39,738.59
	7	\$1,294.63	3.00%	\$1,255.79		\$0.00
4 CY Dumpster	1	\$274.34	3.00%	\$266.11	7	\$22,353.13
	2	\$548.68	3.00%	\$532.22	3	\$19,159.82
	3	\$823.01	3.00%	\$798.32	27	\$258,654.31
	4	\$1,000.09	3.00%	\$970.08	12	\$139,691.92
	5	\$1,172.30	3.00%	\$1,137.13		\$0.00
	6	\$1,367.13	3.00%	\$1,326.12	2	\$31,826.81
	7	\$1,561.96	3.00%	\$1,515.10		\$0.00
6 CY Dumpster	1	\$350.72	3.00%	\$340.19		\$0.00
	2	\$701.43	3.00%	\$680.39	1	\$8,164.66
	3	\$1,052.16	3.00%	\$1,020.59		\$0.00
	4	\$1,305.61	3.00%	\$1,266.45		\$0.00
	5	\$1,554.21	3.00%	\$1,507.58		\$0.00
	6	\$1,825.41	3.00%	\$1,770.65		\$0.00
	7	\$2,096.62	3.00%	\$2,033.72		\$0.00

8 CY to 40 CY Roll-offs	1	\$220.00	3.00%	\$213.40	5	\$12,804.00
	2	\$440.00	3.00%	\$426.80		\$0.00
	3	\$660.00	3.00%	\$640.20		\$0.00
	4	\$880.00	3.00%	\$853.60		\$0.00
	5	\$1,100.00	3.00%	\$1,067.00		\$0.00
	6	\$1,320.00	3.00%	\$1,280.40		\$0.00
	7	\$1,540.00	3.00%	\$1,493.80		\$0.00
Compactor	1	\$250.00	3.00%	\$242.50		\$0.00
	2	\$500.00	3.00%	\$485.00		\$0.00
	3	\$750.00	3.00%	\$727.50		\$0.00
	4	\$1,000.00	3.00%	\$970.00		\$0.00
	5	\$1,250.00	3.00%	\$1,212.50		\$0.00
	6	\$1,500.00	3.00%	\$1,455.00		\$0.00
	7	\$1,750.00	3.00%	\$1,697.50		\$0.00
Total Proposed Annual Amount (2A)						\$1,727,350.69
<p>Permanent Roll-Offs and Compactors: All 8, 10, 20, 30, 40 CY Roll-offs and compactors are pull rates only; total cost will be based on actual Disposal and/or Processing costs. Rates charged to Customers should include the total cost for pull, Processing and Disposal rates.</p> <p>Temporary Roll-offs (Non-permanent service of no more than 30 consecutive days at Customer's site): Shall be charged as accordingly to the Service Rates indicated above and may charge an additional daily rental fee (See Extra Services Fees).</p>						

*Estimated No. of Collections per Week is based on 2019 Customer data submitted by the current non-exclusive commercial franchise waste haulers. Each of the Service Areas have different Customer counts.

Additional Entry: (Proposer may use this space to add additional information such as additional facilities and if Proposer would like to add any additional service levels and Container sizes that may have not been identified above)

The undersigned Proposer offers to perform the work described in the Request for Proposals (RFP) for the following price(s). The Proposer rate(s) (hourly, monthly, etc.) shall include all administrative costs, franchise fees, labor, supervision, overtime, materials, transportation, taxes, equipment, and supplies unless stated otherwise in the RFP. The Proposer understands and agrees that the quantities set forth in the Schedule of Prices by the County are only estimates and based on current hauler submittals. Any unit prices quoted by the Proposer in this Schedule of Prices will apply to the actual quantities of work. The Proposer may use the estimates to develop its cost and rate proposal. The Proposer understands and agrees that each of the Service Areas have different Customer counts. County makes no representation or warranties of any kind, expressed or implied, as to the accuracy of the information set forth in the Schedule of Prices. County will not be liable for any damages or loss of any nature, including, but not limited to, lost profits, resulting from the estimates provided by the County. Proposer agrees to indemnify and hold the County harmless with respect to any issues, disputes, claims, lawsuits resulting from the estimates provided by the County in this solicitation, and in particular, as set forth in the Schedule of Prices. It is the responsibility of the proposer to undertake, at its sole cost, any verification of any and all information necessary for the preparation and submittal of a response to this RFP.

It is the County's sole discretion to select the collection method for each Service Area after receipt of all proposals. The County's selected collection method may not be the lowest cost collection method. The County may consider factors including but not limited to, cost per cubic yard, readiness to implement, regulatory compliance, and waste diversion potential, when deciding upon a collection method for each Service Area.

Instructions: Proposer shall enter proposed monthly rates in the blue boxes below. Proposer must submit a proposal/bid for each collection method: Three-Container, Two-Container and One-Container collection methods. Failure to do so may result in the proposal/bid being rejected as nonresponsive. All proposers should include the 14% franchise fee in their proposed rates. Proposers shall not change the numbers in Column D- Estimated No. of Collections per Week. Column E will auto calculate the Proposed Annual Amount for each service. The Proposed Total Annual Amounts for Collection Services of the County selected collection method will be used for the evaluation evaluated. Proposer is responsible for ensuring accuracy of calculations.

If Proposer does not currently offer the One-Container and Two-Container collection methods, Proposer shall input rates utilizing the facility tipping fee of a potential development of a High Diversion Organic Waste Processing Facility (HDOWPF) located in South Gate which will process Mixed Waste (Refuse and Organic Waste) at \$105 per ton, – OR – another High Diversion Organic Waste Processing Facility of Proposer's choosing with a reasonably similar tipping fee, location, and diversion rate that is in compliance with SB 1383 regulations as defined in 14 CCR Section 18982(a)(33). Proposer may also include in their proposal, an option to provide One-Container or Two-Container Collection Services for select Customers so long as the Proposer's proposal indicates how the results would provide similar diversion and cost effectiveness.

Multifamily Mixed Waste Processing Collection Services (Two-Container A- Gray & Blue Containers)

Gray Container: Allows for the collection of Organic Waste, such as food waste and yard waste, and Refuse.

Blue Container: Limited to traditional Non-Organic Recyclables, such as bottles, and cans, and Organic Waste, such as paper and cardboard.

Note: The following rates apply to Multifamily Customers for collecting Recyclables in the **blue container**.

Processing Facility Name: GRAND CENTRAL
 Processing Material(s): REC Rate (Per Ton) 50

Service Description	Collection Frequency (No. of Pickups per Week)	Monthly Unit Price/Rate	(Discount Rate 3%)	Monthly Unit Price/Rate (Final Discounted Rate)	*Estimated No. of Collections per Week	Annual Amount (Discounted Monthly Unit Price/Rate x Estimated No. of Collections per Week x 12)
32-Gallon Cart	1	\$21.90	3.00%	\$21.25		\$0.00
	2	\$52.98	3.00%	\$51.39		\$0.00
	3	\$61.90	3.00%	\$60.04		\$0.00
	4	\$69.34	3.00%	\$67.26		\$0.00
	5	\$76.80	3.00%	\$74.49		\$0.00
	6	\$80.29	3.00%	\$77.88		\$0.00
	7	\$83.79	3.00%	\$81.28		\$0.00
64-Gallon Cart	1	\$22.81	3.00%	\$22.12		\$0.00
	2	\$54.79	3.00%	\$53.15		\$0.00
	3	\$64.60	3.00%	\$62.66		\$0.00
	4	\$72.94	3.00%	\$70.76		\$0.00
	5	\$81.29	3.00%	\$78.85		\$0.00
	6	\$85.70	3.00%	\$83.13		\$0.00
	7	\$90.11	3.00%	\$87.41		\$0.00
96-Gallon Cart	1	\$23.70	3.00%	\$22.99	1	\$275.85
	2	\$66.43	3.00%	\$64.44		\$0.00
	3	\$82.07	3.00%	\$79.61		\$0.00
	4	\$96.24	3.00%	\$93.36		\$0.00
	5	\$110.41	3.00%	\$107.10		\$0.00
	6	\$120.63	3.00%	\$117.02		\$0.00
	7	\$130.86	3.00%	\$126.94		\$0.00

1 CY Dumpster	1	\$85.03	3.00%	\$82.48	17	\$16,824.93
	2	\$170.06	3.00%	\$164.96	2	\$3,959.05
	3	\$255.09	3.00%	\$247.44	1	\$2,969.23
	4	\$276.64	3.00%	\$268.34	5	\$16,100.32
	5	\$295.01	3.00%	\$286.16		\$0.00
	6	\$310.86	3.00%	\$301.53		\$0.00
	7	\$326.71	3.00%	\$316.91		\$0.00
1.5 CY Dumpster	1	\$87.87	3.00%	\$85.24	58	\$59,323.75
	2	\$175.74	3.00%	\$170.47	55	\$112,510.56
	3	\$263.61	3.00%	\$255.71	64	\$196,382.07
	4	\$288.01	3.00%	\$279.37	11	\$36,876.71
	5	\$309.22	3.00%	\$299.94		\$0.00
	6	\$327.90	3.00%	\$318.07	3	\$11,450.35
	7	\$346.58	3.00%	\$336.19		\$0.00
2 CY Dumpster	1	\$90.72	3.00%	\$88.00	7	\$7,391.61
	2	\$181.42	3.00%	\$175.98	3	\$6,335.30
	3	\$272.14	3.00%	\$263.98	27	\$85,528.24
	4	\$299.37	3.00%	\$290.39	12	\$41,816.05
	5	\$323.44	3.00%	\$313.73		\$0.00
	6	\$344.95	3.00%	\$334.61	2	\$8,030.54
	7	\$366.47	3.00%	\$355.48		\$0.00
3 CY Dumpster	1	\$96.40	3.00%	\$93.51		\$0.00
	2	\$192.79	3.00%	\$187.01	1	\$2,244.13
	3	\$289.18	3.00%	\$280.51		\$0.00
	4	\$322.10	3.00%	\$312.44		\$0.00
	5	\$351.85	3.00%	\$341.29		\$0.00
	6	\$379.06	3.00%	\$367.69		\$0.00
	7	\$406.27	3.00%	\$394.08		\$0.00
4 CY Dumpster	1	\$102.08	3.00%	\$99.02		\$0.00
	2	\$204.16	3.00%	\$198.03		\$0.00
	3	\$306.23	3.00%	\$297.05		\$0.00
	4	\$344.84	3.00%	\$334.49		\$0.00
	5	\$380.26	3.00%	\$368.86		\$0.00
	6	\$413.15	3.00%	\$400.76		\$0.00
	7	\$446.04	3.00%	\$432.66		\$0.00
6 CY Dumpster	1	\$113.45	3.00%	\$110.05		\$0.00
	2	\$226.89	3.00%	\$220.08		\$0.00
	3	\$340.34	3.00%	\$330.13		\$0.00
	4	\$390.30	3.00%	\$378.59		\$0.00
	5	\$437.10	3.00%	\$423.99		\$0.00
	6	\$481.35	3.00%	\$466.91		\$0.00
	7	\$525.60	3.00%	\$509.83		\$0.00
8 CY to 40 CY Roll-offs	1	\$220.00	3.00%	\$213.40	5	\$12,804.00
	2	\$440.00	3.00%	\$426.80		\$0.00
	3	\$660.00	3.00%	\$640.20		\$0.00
	4	\$880.00	3.00%	\$853.60		\$0.00
	5	\$1,100.00	3.00%	\$1,067.00		\$0.00
	6	\$1,320.00	3.00%	\$1,280.40		\$0.00
	7	\$1,540.00	3.00%	\$1,493.80		\$0.00
Compactor	1	\$250.00	3.00%	\$242.50		\$0.00
	2	\$500.00	3.00%	\$485.00		\$0.00
	3	\$750.00	3.00%	\$727.50		\$0.00
	4	\$1,000.00	3.00%	\$970.00		\$0.00
	5	\$1,250.00	3.00%	\$1,212.50		\$0.00
	6	\$1,500.00	3.00%	\$1,455.00		\$0.00
	7	\$1,750.00	3.00%	\$1,697.50		\$0.00
Total Proposed Annual Amount (2B)						\$620,822.68

Permanent Roll-Offs and Compactors: All 8, 10, 20, 30, 40 CY Roll-offs and compactors are pull rates only; total cost will be based on actual Disposal and/or Processing costs. Rates charged to Customers should include the total cost for pull, Processing and Disposal rates.

Temporary Roll-offs (Non-permanent service of no more than 30 consecutive days at Customer's site): Shall be charged as accordingly to the Service Rates indicated above and may charge an additional daily rental fee (See Extra Services Fees).

*Estimated No. of Collections per Week is based on 2019 Customer data submitted by the current non-exclusive commercial franchise waste haulers. Each of the Service Areas have different Customer counts.

Additional Entry: *(Proposer may use this space to add additional information such as additional facilities and if Proposer would like to add any additional service levels and Container sizes that may have not been identified above)*

The undersigned Proposer offers to perform the work described in the Request for Proposals (RFP) for the following price(s). The Proposer rate(s) (hourly, monthly, etc.) shall include all administrative costs, franchise fees, labor, supervision, overtime, materials, transportation, taxes, equipment, and supplies unless stated otherwise in the RFP. The Proposer understands and agrees that the quantities set forth in the Schedule of Prices by the County are only estimates are based on current hauler submittals. Any unit prices quoted by the Proposer in this Schedule of Prices will apply to the actual quantities of work. The Proposer may use the estimates to develop its cost and rate proposal. The Proposer understands and agrees that each of the Service Areas have different Customer counts. County makes no representation or warranties of any kind, expressed or implied, as to the accuracy of the information set forth in the Schedule of Prices. County will not be liable for any damages or loss of any nature, including, but not limited to, lost profits, resulting from the estimates provided by the County. Proposer agrees to indemnify and hold the County harmless with respect to any issues, disputes, claims, lawsuits resulting from the estimates provided by the County in this solicitation, and in particular, as set forth in the Schedule of Prices. It is the responsibility of the proposer to undertake, at its sole cost, any verification of any and all information necessary for the preparation and submittal of a response to this RFP.

It is the County's sole discretion to select the collection method for each Service Area after receipt of all proposals. The County's selected collection method may not be the lowest cost collection method. The County may consider factors including but not limited to, cost per cubic yard, readiness to implement, regulatory compliance, and waste diversion potential, when deciding upon a collection method for each Service Area.

Instructions: Proposer shall enter proposed monthly rates in the blue boxes below. Proposer must submit a proposal/bid for each collection method: Three-Container, Two-Container and One-Container collection methods. Failure to do so may result in the proposal/bid being rejected as nonresponsive. All proposers should include the 14% franchise fee in their proposed rates. Proposers shall not change the numbers in Column D- Estimated No. of Collections per Week. Column E will auto calculate the Proposed Annual Amount for each service. The Proposed Total Annual Amounts for Collection Services of the County selected collection method will be used for the evaluation evaluated. Proposer is responsible for ensuring accuracy of calculations.

If Proposer does not currently offer the One-Container and Two-Container collection methods, Proposer shall input rates utilizing the facility tipping fee of a potential development of a High Diversion Organic Waste Processing Facility (HDOWPF) located in South Gate which will process Mixed Waste (Refuse and Organic Waste) at \$105 per ton, – OR – another High Diversion Organic Waste Processing Facility of Proposer's choosing with a reasonably similar tipping fee, location, and diversion rate that is in compliance with SB 1383 regulations as defined in 14 CCR Section 18982(a)(33). Proposer may also include in their proposal, an option to provide One-Container or Two-Container Collection Services for select Customers so long as the Proposer's proposal indicates how the results would provide similar diversion and cost effectiveness.

Multifamily Mixed Waste Processing Collection Services (Two-Container B- Gray & Green Containers)

Gray Container: Allows for the collection of intentional commingled wastes including Organic Waste (paper, cardboard) and Non-Organic Recyclables (bottles and cans), and Refuse.

Green Container: Limited to only Organic Waste sent to a source separated organics facility. This includes food waste and yard waste.

Note: The following rates apply to Multifamily Customers for collecting all commingled wastes & Non-Organic Recyclables in the **gray container**.

Processing Facility Name: **GRAND CENTRAL RECYCLING AND TRANSFER**

Processing Material(s): **MSW/REC Rate (Per Ton) \$77.84**

Service Description	Collection Frequency (No. of Pickups per Week)	Monthly Unit Price/Rate	(Discount Rate 3%)	Monthly Unit Price/Rate (Final Discounted Rate)	*Estimated No. of Collections per Week	Annual Amount (Discounted Monthly Unit Price/Rate x Estimated No. of Collections per Week x 12)
32-Gallon Cart	1	\$33.16	3.00%	\$32.17		\$0.00
	2	\$54.96	3.00%	\$53.31		\$0.00
	3	\$74.39	3.00%	\$72.16		\$0.00
	4	\$93.15	3.00%	\$90.36		\$0.00
	5	\$111.91	3.00%	\$108.55		\$0.00
	6	\$128.87	3.00%	\$125.00		\$0.00
	7	\$145.82	3.00%	\$141.45		\$0.00
64-Gallon Cart	1	\$37.58	3.00%	\$36.45		\$0.00
	2	\$62.29	3.00%	\$60.42		\$0.00
	3	\$84.31	3.00%	\$81.78		\$0.00
	4	\$105.56	3.00%	\$102.39		\$0.00
	5	\$126.83	3.00%	\$123.03		\$0.00
	6	\$146.05	3.00%	\$141.67		\$0.00
	7	\$165.26	3.00%	\$160.30		\$0.00
96-Gallon Cart	1	\$44.22	3.00%	\$42.89		\$0.00
	2	\$73.28	3.00%	\$71.08		\$0.00
	3	\$99.18	3.00%	\$96.20		\$0.00
	4	\$124.19	3.00%	\$120.46		\$0.00
	5	\$149.22	3.00%	\$144.74		\$0.00
	6	\$171.82	3.00%	\$166.67		\$0.00
	7	\$194.43	3.00%	\$188.60		\$0.00
1 CY Dumpster	1	\$108.27	3.00%	\$105.02	1	\$1,260.26
	2	\$216.52	3.00%	\$210.02		\$0.00
	3	\$324.79	3.00%	\$315.05		\$0.00
	4	\$361.17	3.00%	\$350.33		\$0.00
	5	\$393.94	3.00%	\$382.12		\$0.00
	6	\$443.44	3.00%	\$430.14		\$0.00
	7	\$492.93	3.00%	\$478.14		\$0.00
1.5 CY Dumpster	1	\$117.46	3.00%	\$113.94	1	\$1,367.23
	2	\$234.93	3.00%	\$227.88	1	\$2,734.59
	3	\$352.39	3.00%	\$341.82		\$0.00
	4	\$397.97	3.00%	\$386.03		\$0.00
	5	\$439.95	3.00%	\$426.75		\$0.00
	6	\$498.65	3.00%	\$483.69		\$0.00
	7	\$557.34	3.00%	\$540.62		\$0.00

2 CY Dumpster	1	\$126.66	3.00%	\$122.86	16	\$23,589.16
	2	\$253.33	3.00%	\$245.73	1	\$2,948.76
	3	\$380.00	3.00%	\$368.60	1	\$4,423.20
	4	\$434.77	3.00%	\$421.73	5	\$25,303.61
	5	\$485.95	3.00%	\$471.37		\$0.00
	6	\$553.85	3.00%	\$537.23		\$0.00
	7	\$621.76	3.00%	\$603.11		\$0.00
3 CY Dumpster	1	\$145.07	3.00%	\$140.72	58	\$97,939.66
	2	\$290.14	3.00%	\$281.44	55	\$185,747.63
	3	\$435.20	3.00%	\$422.14	64	\$324,206.59
	4	\$508.39	3.00%	\$493.14	11	\$65,094.26
	5	\$577.97	3.00%	\$560.63		\$0.00
	6	\$664.27	3.00%	\$644.34	3	\$23,196.31
	7	\$750.57	3.00%	\$728.05		\$0.00
4 CY Dumpster	1	\$163.47	3.00%	\$158.57	7	\$13,319.54
	2	\$326.94	3.00%	\$317.13	3	\$11,416.74
	3	\$490.41	3.00%	\$475.70	27	\$154,126.05
	4	\$581.99	3.00%	\$564.53	12	\$81,292.36
	5	\$669.98	3.00%	\$649.88		\$0.00
	6	\$774.68	3.00%	\$751.44	2	\$18,034.55
	7	\$879.38	3.00%	\$853.00		\$0.00
6 CY Dumpster	1	\$200.28	3.00%	\$194.27		\$0.00
	2	\$400.55	3.00%	\$388.53	1	\$4,662.40
	3	\$600.83	3.00%	\$582.81		\$0.00
	4	\$729.21	3.00%	\$707.33		\$0.00
	5	\$854.01	3.00%	\$828.39		\$0.00
	6	\$995.52	3.00%	\$965.65		\$0.00
	7	\$1,137.03	3.00%	\$1,102.92		\$0.00
8 CY to 40 CY Roll-offs	1	\$220.00	3.00%	\$213.40	5	\$12,804.00
	2	\$440.00	3.00%	\$426.80		\$0.00
	3	\$660.00	3.00%	\$640.20		\$0.00
	4	\$880.00	3.00%	\$853.60		\$0.00
	5	\$1,100.00	3.00%	\$1,067.00		\$0.00
	6	\$1,320.00	3.00%	\$1,280.40		\$0.00
	7	\$1,540.00	3.00%	\$1,493.80		\$0.00
Compactor	1	\$250.00	3.00%	\$242.50		\$0.00
	2	\$500.00	3.00%	\$485.00		\$0.00
	3	\$750.00	3.00%	\$727.50		\$0.00
	4	\$1,000.00	3.00%	\$970.00		\$0.00
	5	\$1,250.00	3.00%	\$1,212.50		\$0.00
	6	\$1,500.00	3.00%	\$1,455.00		\$0.00
	7	\$1,750.00	3.00%	\$1,697.50		\$0.00
Total Proposed Annual Amount (2C)						\$1,053,466.91
Permanent Roll-Offs and Compactors: All 8, 10, 20, 30, 40 CY Roll-offs and compactors are pull rates only; total cost will be based on actual Disposal and/or Processing costs. Rates charged to Customers should include the total cost for pull, Processing and Disposal rates. Temporary Roll-offs (Non-permanent service of no more than 30 consecutive days at Customer's site): Shall be charged as accordingly to the Service Rates indicated above and may charge an additional daily rental fee (See Extra Services Fees).						

*Estimated No. of Collections per Week is based on 2019 Customer data submitted by the current non-exclusive commercial franchise waste haulers. Each of the Service Areas have different Customer counts.

Additional Entry: (Proposer may use this space to add additional information such as additional facilities and if Proposer would like to add any additional service levels and Container sizes that may have not been identified above)
TEMP ROLLOFF \$538.00 PER TON \$77.84

The undersigned Proposer offers to perform the work described in the Request for Proposals (RFP) for the following price(s). The Proposer rate(s) (hourly, monthly, etc.) shall include all administrative costs, franchise fees, labor, supervision, overtime, materials, transportation, taxes, equipment, and supplies unless stated otherwise in the RFP. The Proposer understands and agrees that the quantities set forth in the Schedule of Prices by the County are only estimates are based on current hauler submittals. Any unit prices quoted by the Proposer in this Schedule of Prices will apply to the actual quantities of work. The Proposer may use the estimates to develop its cost and rate proposal. The Proposer understands and agrees that each of the Service Areas have different Customer counts. County makes no representation or warranties of any kind, expressed or implied, as to the accuracy of the information set forth in the Schedule of Prices. County will not be liable for any damages or loss of any nature, including, but not limited to, lost profits, resulting from the estimates provided by the County. Proposer agrees to indemnify and hold the County harmless with respect to any issues, disputes, claims, lawsuits resulting from the estimates provided by the County in this solicitation, and in particular, as set forth in the Schedule of Prices. It is the responsibility of the proposer to undertake, at its sole cost, any verification of any and all information necessary for the preparation and submittal of a response to this RFP.

It is the County's sole discretion to select the collection method for each Service Area after receipt of all proposals. The County's selected collection method may not be the lowest cost collection method. The County may consider factors including but not limited to, cost per cubic yard, readiness to implement, regulatory compliance, and waste diversion potential, when deciding upon a collection method for each Service Area.

Instructions: Proposer shall enter proposed monthly rates in the blue boxes below. Proposer must submit a proposal/bid for each collection method: Three-Container, Two-Container and One-Container collection methods. Failure to do so may result in the proposal/bid being rejected as nonresponsive. All proposers should include the 14% franchise fee in their proposed rates. Proposers shall not change the numbers in Column D- Estimated No. of Collections per Week. Column E will auto calculate the Proposed Annual Amount for each service. The Proposed Total Annual Amounts for Collection Services of the County selected collection method will be used for the evaluation evaluated. Proposer is responsible for ensuring accuracy of calculations.

If Proposer does not currently offer the One-Container and Two-Container collection methods, Proposer shall input rates utilizing the facility tipping fee of a potential development of a High Diversion Organic Waste Processing Facility (HDOWPF) located in South Gate which will process Mixed Waste (Refuse and Organic Waste) at \$105 per ton, – OR – another High Diversion Organic Waste Processing Facility of Proposer's choosing with a reasonably similar tipping fee, location, and diversion rate that is in compliance with SB 1383 regulations as defined in 14 CCR Section 18982(a)(33). Proposer may also include in their proposal, an option to provide One-Container or Two-Container Collection Services for select Customers so long as the Proposer's proposal indicates how the results would provide similar diversion and cost effectiveness.

Multifamily Mixed Waste Processing Collection Services (Two-Container B- Gray & Green Containers)

Gray Container: Allows for the collection of intentional commingled wastes including Organic Waste (paper, cardboard) and Non-Organic Recyclables (bottles and cans), and Refuse.

Green Container: Limited to only Organic Waste sent to a source separated organics facility. This includes food waste and yard waste.

Note: The following rates apply to Multifamily Customers for collecting Organic Waste in the **green container**.

Processing Facility Name: **GRAND CENTRAL RECYCLING AND TRANSFER**
 Processing Material(s): **ORG/YARD Rate (Per Ton) \$105.00**

Service Description	Collection Frequency (No. of Pickups per Week)	Monthly Unit Price/Rate	(Discount Rate 3%)	Monthly Unit Price/Rate (Final Discounted Rate)	*Estimated No. of Collections per Week	Annual Amount (Discounted Monthly Unit Price/Rate x Estimated No. of Collections per Week x 12)
32-Gallon Cart	1	\$49.91	3.00%	\$48.41		\$0.00
	2	\$99.81	3.00%	\$96.82		\$0.00
	3	\$149.71	3.00%	\$145.22		\$0.00
	4	\$199.61	3.00%	\$193.63		\$0.00
	5	\$249.52	3.00%	\$242.04		\$0.00
	6	\$299.42	3.00%	\$290.44		\$0.00
	7	\$349.33	3.00%	\$338.85		\$0.00
64-Gallon Cart	1	\$56.56	3.00%	\$54.87	1	\$658.38
	2	\$113.12	3.00%	\$109.72		\$0.00
	3	\$169.67	3.00%	\$164.58		\$0.00
	4	\$226.23	3.00%	\$219.44		\$0.00
	5	\$282.79	3.00%	\$274.31		\$0.00
	6	\$339.35	3.00%	\$329.17		\$0.00
	7	\$395.90	3.00%	\$384.02		\$0.00
96-Gallon Cart	1	\$66.54	3.00%	\$64.55	1	\$774.57
	2	\$133.08	3.00%	\$129.09	1	\$1,549.05
	3	\$199.62	3.00%	\$193.63		\$0.00
	4	\$266.15	3.00%	\$258.17		\$0.00
	5	\$332.70	3.00%	\$322.71		\$0.00
	6	\$399.23	3.00%	\$387.25		\$0.00
	7	\$465.77	3.00%	\$451.79		\$0.00

1 CY Dumpster	1	\$108.96	3.00%	\$105.69	74	\$93,853.79
	2	\$217.91	3.00%	\$211.37	56	\$142,042.45
	3	\$326.87	3.00%	\$317.06	65	\$247,309.84
	4	\$363.93	3.00%	\$353.01	16	\$67,778.32
	5	\$397.40	3.00%	\$385.48		\$0.00
	6	\$447.59	3.00%	\$434.16	3	\$15,629.84
	7	\$497.79	3.00%	\$482.86		\$0.00
1.5 CY Dumpster	1	\$118.50	3.00%	\$114.95	7	\$9,655.38
	2	\$237.01	3.00%	\$229.90	3	\$8,276.39
	3	\$355.51	3.00%	\$344.84	27	\$111,729.68
	4	\$402.13	3.00%	\$390.07	12	\$56,169.52
	5	\$445.15	3.00%	\$431.80		\$0.00
	6	\$504.87	3.00%	\$489.72	2	\$11,753.37
	7	\$564.60	3.00%	\$547.66		\$0.00
2 CY Dumpster	1	\$128.05	3.00%	\$124.21		\$0.00
	2	\$256.10	3.00%	\$248.42	1	\$2,981.00
	3	\$384.15	3.00%	\$372.63		\$0.00
	4	\$440.31	3.00%	\$427.10		\$0.00
	5	\$492.88	3.00%	\$478.09		\$0.00
	6	\$562.16	3.00%	\$545.30		\$0.00
	7	\$631.44	3.00%	\$612.50		\$0.00
3 CY Dumpster	1	\$147.15	3.00%	\$142.74		\$0.00
	2	\$294.29	3.00%	\$285.46		\$0.00
	3	\$441.43	3.00%	\$428.19		\$0.00
	4	\$516.69	3.00%	\$501.19		\$0.00
	5	\$588.36	3.00%	\$570.71		\$0.00
	6	\$676.74	3.00%	\$656.44		\$0.00
	7	\$765.12	3.00%	\$742.17		\$0.00
4 CY Dumpster	1	\$166.24	3.00%	\$161.25		\$0.00
	2	\$332.48	3.00%	\$322.51		\$0.00
	3	\$498.72	3.00%	\$483.76		\$0.00
	4	\$593.08	3.00%	\$575.29		\$0.00
	5	\$683.83	3.00%	\$663.32		\$0.00
	6	\$791.30	3.00%	\$767.56		\$0.00
	7	\$898.77	3.00%	\$871.81		\$0.00
6 CY Dumpster	1	\$204.44	3.00%	\$198.31		\$0.00
	2	\$408.86	3.00%	\$396.59		\$0.00
	3	\$613.30	3.00%	\$594.90		\$0.00
	4	\$745.83	3.00%	\$723.46		\$0.00
	5	\$874.79	3.00%	\$848.55		\$0.00
	6	\$1,020.45	3.00%	\$989.84		\$0.00
	7	\$1,166.12	3.00%	\$1,131.14		\$0.00
8 CY to 40 CY Roll-offs	1	\$220.00	3.00%	\$213.40	5	\$12,804.00
	2	\$440.00	3.00%	\$426.80		\$0.00
	3	\$660.00	3.00%	\$640.20		\$0.00
	4	\$880.00	3.00%	\$853.60		\$0.00
	5	\$1,100.00	3.00%	\$1,067.00		\$0.00
	6	\$1,320.00	3.00%	\$1,280.40		\$0.00
	7	\$1,540.00	3.00%	\$1,493.80		\$0.00
Compactor	1	\$250.00	3.00%	\$242.50		\$0.00
	2	\$500.00	3.00%	\$485.00		\$0.00
	3	\$750.00	3.00%	\$727.50		\$0.00
	4	\$1,000.00	3.00%	\$970.00		\$0.00
	5	\$1,250.00	3.00%	\$1,212.50		\$0.00
	6	\$1,500.00	3.00%	\$1,455.00		\$0.00
	7	\$1,750.00	3.00%	\$1,697.50		\$0.00
Total Proposed Annual Amount (2D)						\$782,965.60

Permanent Roll-Offs and Compactors: All 8, 10, 20, 30, 40 CY Roll-offs and compactors are pull rates only; total cost will be based on actual Disposal and/or Processing costs. Rates charged to Customers should include the total cost for pull, Processing and Disposal rates.
Temporary Roll-offs (Non-permanent service of no more than 30 consecutive days at Customer's site): Shall be charged as accordingly to the Service Rates indicated above and may charge an additional daily rental fee (See Extra Services Fees).

*Estimated No. of Collections per Week is based on 2019 Customer data submitted by the current non-exclusive commercial franchise waste haulers. Each of the Service Areas have different Customer counts.

Additional Entry: (Proposer may use this space to add additional information such as additional facilities and if Proposer would like to add any additional service levels and Container sizes that may have not been identified above) **TEMP ROLLOFF \$538.00 PER TON \$77.84**

The undersigned Proposer offers to perform the work described in the Request for Proposals (RFP) for the following price(s). The Proposer rate(s) (hourly, monthly, etc.) shall include all administrative costs, franchise fees, labor, supervision, overtime, materials, transportation, taxes, equipment, and supplies unless stated otherwise in the RFP. The Proposer understands and agrees that the quantities set forth in the Schedule of Prices by the County are only estimates are based on current hauler submittals. Any unit prices quoted by the Proposer in this Schedule of Prices will apply to the actual quantities of work. The Proposer may use the estimates to develop its cost and rate proposal. The Proposer understands and agrees that each of the Service Areas have different Customer counts. County makes no representation or warranties of any kind, expressed or implied, as to the accuracy of the information set forth in the Schedule of Prices. County will not be liable for any damages or loss of any nature, including, but not limited to, lost profits, resulting from the estimates provided by the County. Proposer agrees to indemnify and hold the County harmless with respect to any issues, disputes, claims, lawsuits resulting from the estimates provided by the County in this solicitation, and in particular, as set forth in the Schedule of Prices. It is the responsibility of the proposer to undertake, at its sole cost, any verification of any and all information necessary for the preparation and submittal of a response to this RFP.

It is the County's sole discretion to select the collection method for each Service Area after receipt of all proposals. The County's selected collection method may not be the lowest cost collection method. The County may consider factors including but not limited to, cost per cubic yard, readiness to implement, regulatory compliance, and waste diversion potential, when deciding upon a collection method for each Service Area.

Instructions: Proposer shall enter proposed monthly rates in the blue boxes below. Proposer must submit a proposal/bid for each collection method: Three-Container, Two-Container and One-Container collection methods. Failure to do so may result in the proposal/bid being rejected as nonresponsive. All proposers should include the 14% franchise fee in their proposed rates. Proposers shall not change the numbers in Column D- Estimated No. of Collections per Week. Column E will auto calculate the Proposed Annual Amount for each service. The Proposed Total Annual Amounts for Collection Services of the County selected collection method will be used for the evaluation evaluated. Proposer is responsible for ensuring accuracy of calculations.

If Proposer does not currently offer the One-Container and Two-Container collection methods, Proposer shall input rates utilizing the facility tipping fee of a potential development of a High Diversion Organic Waste Processing Facility (HDOWPF) located in South Gate which will process Mixed Waste (Refuse and Organic Waste) at \$105 per ton, – OR – another High Diversion Organic Waste Processing Facility of Proposer's choosing with a reasonably similar tipping fee, location, and diversion rate that is in compliance with SB 1383 regulations as defined in 14 CCR Section 18982(a)(33). Proposer may also include in their proposal, an option to provide One-Container or Two-Container Collection Services for select Customers so long as the Proposer's proposal indicates how the results would provide similar diversion and cost effectiveness.

Multifamily Mixed Waste Processing Collection Services (One-Container)

Note: The following rates apply to Multifamily Customers for collecting Refuse, Recycling and Organic Waste materials into a single gray container.

Processing Facility Name: **GRAND CENTRAL RECYCLING AND TRANSFER**

Processing Material(s): **MSW/REC/ORG/YARD Rate (Per Ton) \$105.00**

Service Description	Collection Frequency (No. of Pickups per Week)	Monthly Unit Price/Rate	(Discount Rate 3%)	Monthly Unit Price/Rate (Final Discounted Rate)	*Estimated No. of Collections per Week	Annual Amount (Discounted Monthly Unit Price/Rate x Estimated No. of Collections per Week x 12)
32-Gallon Cart	1	\$33.16	3.00%	\$32.17		\$0.00
	2	\$54.96	3.00%	\$53.31		\$0.00
	3	\$74.39	3.00%	\$72.16		\$0.00
	4	\$93.15	3.00%	\$90.36		\$0.00
	5	\$111.91	3.00%	\$108.55		\$0.00
	6	\$128.87	3.00%	\$125.00		\$0.00
	7	\$145.82	3.00%	\$141.45		\$0.00
64-Gallon Cart	1	\$37.58	3.00%	\$36.45		\$0.00
	2	\$62.29	3.00%	\$60.42		\$0.00
	3	\$84.31	3.00%	\$81.78		\$0.00
	4	\$105.56	3.00%	\$102.39		\$0.00
	5	\$126.83	3.00%	\$123.03		\$0.00
	6	\$146.05	3.00%	\$141.67		\$0.00
	7	\$165.26	3.00%	\$160.30		\$0.00
96-Gallon Cart	1	\$44.22	3.00%	\$42.89		\$0.00
	2	\$73.28	3.00%	\$71.08		\$0.00
	3	\$99.18	3.00%	\$96.20		\$0.00
	4	\$124.19	3.00%	\$120.46		\$0.00
	5	\$149.22	3.00%	\$144.74		\$0.00
	6	\$171.82	3.00%	\$166.67		\$0.00
	7	\$194.43	3.00%	\$188.60		\$0.00
1 CY Dumpster	1	\$114.68	3.00%	\$111.24	1	\$1,334.88
	2	\$229.36	3.00%	\$222.48		\$0.00
	3	\$344.05	3.00%	\$333.73		\$0.00
	4	\$386.85	3.00%	\$375.24		\$0.00
	5	\$426.05	3.00%	\$413.27		\$0.00
	6	\$481.96	3.00%	\$467.50		\$0.00
	7	\$537.87	3.00%	\$521.73		\$0.00

1.5 CY Dumpster	1	\$127.09	3.00%	\$123.28	1	\$1,479.33
	2	\$254.20	3.00%	\$246.57	1	\$2,958.89
	3	\$381.29	3.00%	\$369.85		\$0.00
	4	\$436.49	3.00%	\$423.40		\$0.00
	5	\$488.10	3.00%	\$473.46		\$0.00
	6	\$556.44	3.00%	\$539.75		\$0.00
	7	\$624.77	3.00%	\$606.03		\$0.00
2 CY Dumpster	1	\$139.50	3.00%	\$135.32	16	\$25,980.48
	2	\$279.02	3.00%	\$270.65	1	\$3,247.79
	3	\$418.52	3.00%	\$405.96	1	\$4,871.57
	4	\$486.14	3.00%	\$471.56	5	\$28,293.35
	5	\$550.17	3.00%	\$533.66		\$0.00
	6	\$630.90	3.00%	\$611.97		\$0.00
	7	\$711.64	3.00%	\$690.29		\$0.00
3 CY Dumpster	1	\$164.34	3.00%	\$159.41	58	\$110,949.22
	2	\$328.66	3.00%	\$318.80	55	\$210,408.13
	3	\$493.00	3.00%	\$478.21	64	\$367,265.28
	4	\$585.43	3.00%	\$567.87	11	\$74,958.46
	5	\$674.29	3.00%	\$654.06		\$0.00
	6	\$779.85	3.00%	\$756.45	3	\$27,232.36
	7	\$885.40	3.00%	\$858.84		\$0.00
4 CY Dumpster	1	\$189.16	3.00%	\$183.49	7	\$15,412.76
	2	\$378.31	3.00%	\$366.96	3	\$13,210.59
	3	\$567.46	3.00%	\$550.44	27	\$178,341.33
	4	\$684.73	3.00%	\$664.19	12	\$95,643.09
	5	\$798.41	3.00%	\$774.46		\$0.00
	6	\$928.79	3.00%	\$900.93	2	\$21,622.23
	7	\$1,059.17	3.00%	\$1,027.39		\$0.00
6 CY Dumpster	1	\$238.80	3.00%	\$231.64		\$0.00
	2	\$477.60	3.00%	\$463.27	1	\$5,559.26
	3	\$716.41	3.00%	\$694.92		\$0.00
	4	\$883.32	3.00%	\$856.82		\$0.00
	5	\$1,046.64	3.00%	\$1,015.24		\$0.00
	6	\$1,226.67	3.00%	\$1,189.87		\$0.00
	7	\$1,406.71	3.00%	\$1,364.51		\$0.00
8 CY to 40 CY Roll-offs	1	\$220.00	3.00%	\$213.40	5	\$12,804.00
	2	\$440.00	3.00%	\$426.80		\$0.00
	3	\$660.00	3.00%	\$640.20		\$0.00
	4	\$880.00	3.00%	\$853.60		\$0.00
	5	\$1,100.00	3.00%	\$1,067.00		\$0.00
	6	\$1,320.00	3.00%	\$1,280.40		\$0.00
	7	\$1,540.00	3.00%	\$1,493.80		\$0.00
Compactor	1	\$250.00	3.00%	\$242.50		\$0.00
	2	\$500.00	3.00%	\$485.00		\$0.00
	3	\$750.00	3.00%	\$727.50		\$0.00
	4	\$1,000.00	3.00%	\$970.00		\$0.00
	5	\$1,250.00	3.00%	\$1,212.50		\$0.00
	6	\$1,500.00	3.00%	\$1,455.00		\$0.00
	7	\$1,750.00	3.00%	\$1,697.50		\$0.00
Total Proposed Annual Amount (2E)						\$1,201,572.99

Permanent Roll-Offs and Compactors: All 8, 10, 20, 30, 40 CY Roll-offs and compactors are pull rates only; total cost will be based on actual Disposal and/or Processing costs. Rates charged to Customers should include the total cost for pull, Processing and Disposal rates.

Temporary Roll-offs (Non-permanent service of no more than 30 consecutive days at Customer's site): Shall be charged as accordingly to the Service Rates indicated above and may charge an additional daily rental fee (See Extra Services Fees).

*Estimated No. of Collections per Week is based on 2019 Customer data submitted by the current non-exclusive commercial franchise waste haulers. Each of the Service Areas have different Customer counts.

Additional Entry: (Proposer may use this space to add additional information such as additional facilities and if Proposer would like to add any additional service levels and Container sizes that may have not been identified above) **TEMP ROLLOFF \$538.00 PER TON \$77.84**

The undersigned Proposer offers to perform the work described in the Request for Proposals (RFP) for the following price(s). The Proposer rate(s) (hourly, monthly, etc.) shall include all administrative costs, franchise fees, labor, supervision, overtime, materials, transportation, taxes, equipment, and supplies unless stated otherwise in the RFP. The Proposer understands and agrees that the quantities set forth in the Schedule of Prices by the County are only estimates are based on current hauler submittals. Any unit prices quoted by the Proposer in this Schedule of Prices will apply to the actual quantities of work. The Proposer may use the estimates to develop its cost and rate proposal. The Proposer understands and agrees that each of the Service Areas have different Customer counts. County makes no representation or warranties of any kind, expressed or implied, as to the accuracy of the information set forth in the Schedule of Prices. County will not be liable for any damages or loss of any nature, including, but not limited to, lost profits, resulting from the estimates provided by the County. Proposer agrees to indemnify and hold the County harmless with respect to any issues, disputes, claims, lawsuits resulting from the estimates provided by the County in this solicitation, and in particular, as set forth in the Schedule of Prices. It is the responsibility of the proposer to undertake, at its sole cost, any verification of any and all information necessary for the preparation and submittal of a response to this RFP.

It is the County's sole discretion to select the collection method for each Service Area after receipt of all proposals. The County's selected collection method may not be the lowest cost collection method. The County may consider factors including but not limited to, cost per cubic yard, readiness to implement, regulatory compliance, and waste diversion potential, when deciding upon a collection method for each Service Area.

Instructions: Proposer shall enter proposed monthly rates in the blue boxes below. Proposer must submit a proposal/bid for each collection method: Three-Container, Two-Container and One-Container collection methods. Failure to do so may result in the proposal/bid being rejected as nonresponsive. All proposers should include the 14% franchise fee in their proposed rates. Proposers shall not change the numbers in Column D- Estimated No. of Collections per Week. Column E will auto calculate the Proposed Annual Amount for each service. The Proposed Total Annual Amounts for Collection Services of the County selected collection method will be used for the evaluation evaluated. Proposer is responsible for ensuring accuracy of calculations.

If Proposer does not currently offer the One-Container and Two-Container collection methods, Proposer shall input rates utilizing the facility tipping fee of a potential development of a High Diversion Organic Waste Processing Facility (HDOWPF) located in South Gate which will process Mixed Waste (Refuse and Organic Waste) at \$105 per ton, – OR – another High Diversion Organic Waste Processing Facility of Proposer's choosing with a reasonably similar tipping fee, location, and diversion rate that is in compliance with SB 1383 regulations as defined in 14 CCR Section 18982(a)(33). Proposer may also include in their proposal, an option to provide One-Container or Two-Container Collection Services for select Customers so long as the Proposer's proposal indicates how the results would provide similar diversion and cost effectiveness.

Residential Mixed Waste Processing Collection Services (Two-Container A- Gray & Blue Containers)

Gray Container: Allows for the collection of Organic Waste, such as food waste and yard waste, and Refuse.

Blue Container: Limited to traditional Non-Organic Recyclables, such as bottles, and cans, and Organic Waste, such as paper and cardboard.

Note: The following rates apply to Residential Customers for collecting Refuse and Organic Waste in the **gray container**.

Processing Facility Name: SOUTHGATE
 Processing Material(s): ORG YARD REFUSE Rate (Per Ton) 105

Service Description	Collection Frequency (No. of Pickups per Week)	Monthly Unit Price/Rate	(Discount Rate 3%)	Monthly Unit Price/Rate (Final Discounted Rate)	*Estimated No. of Collections per Week	Annual Amount (Discounted Monthly Unit Price/Rate x Estimated No. of Collections per Week x 12)
32-Gallon Cart	1	\$26.58	3.00%	\$25.78		\$0.00
	2	\$53.16	3.00%	\$51.56		\$0.00
	3	\$79.74	3.00%	\$77.34		\$0.00
	4	\$90.13	3.00%	\$87.43		\$0.00
	5	\$99.72	3.00%	\$96.73		\$0.00
	6	\$113.07	3.00%	\$109.68		\$0.00
	7	\$126.42	3.00%	\$122.63		\$0.00
64-Gallon Cart	1	\$53.16	3.00%	\$51.56		\$0.00
	2	\$106.31	3.00%	\$103.12		\$0.00
	3	\$159.47	3.00%	\$154.69		\$0.00
	4	\$180.27	3.00%	\$174.86		\$0.00
	5	\$199.44	3.00%	\$193.46		\$0.00
	6	\$226.15	3.00%	\$219.36		\$0.00
	7	\$252.85	3.00%	\$245.26		\$0.00
96-Gallon Cart	1	\$79.73	3.00%	\$77.34		\$0.00
	2	\$159.47	3.00%	\$154.68		\$0.00
	3	\$239.21	3.00%	\$232.03		\$0.00
	4	\$270.40	3.00%	\$262.29		\$0.00
	5	\$299.17	3.00%	\$290.19		\$0.00
	6	\$339.22	3.00%	\$329.04		\$0.00
	7	\$379.27	3.00%	\$367.89		\$0.00

1 CY Dumpster	1	\$159.76	3.00%	\$154.97	1	\$1,859.64
	2	\$319.53	3.00%	\$309.94		\$0.00
	3	\$479.30	3.00%	\$464.92		\$0.00
	4	\$541.80	3.00%	\$525.55		\$0.00
	5	\$599.44	3.00%	\$581.46		\$0.00
	6	\$679.70	3.00%	\$659.31		\$0.00
	7	\$759.95	3.00%	\$737.15		\$0.00
1.5 CY Dumpster	1	\$178.86	3.00%	\$173.50	28	\$58,294.81
	2	\$357.72	3.00%	\$346.99		\$0.00
	3	\$536.58	3.00%	\$520.48		\$0.00
	4	\$618.18	3.00%	\$599.63		\$0.00
	5	\$694.92	3.00%	\$674.07		\$0.00
	6	\$794.27	3.00%	\$770.44		\$0.00
	7	\$893.62	3.00%	\$866.82		\$0.00
2 CY Dumpster	1	\$197.95	3.00%	\$192.01	37	\$85,253.67
	2	\$395.91	3.00%	\$384.04		\$0.00
	3	\$593.86	3.00%	\$576.05		\$0.00
	4	\$694.57	3.00%	\$673.73		\$0.00
	5	\$790.40	3.00%	\$766.68		\$0.00
	6	\$908.84	3.00%	\$881.57		\$0.00
	7	\$1,027.28	3.00%	\$996.46		\$0.00
3 CY Dumpster	1	\$236.15	3.00%	\$229.07	177	\$486,535.77
	2	\$472.29	3.00%	\$458.12	28	\$153,928.80
	3	\$708.44	3.00%	\$687.19	2	\$16,492.49
	4	\$847.32	3.00%	\$821.90	10	\$98,628.14
	5	\$981.35	3.00%	\$951.91		\$0.00
	6	\$1,137.99	3.00%	\$1,103.85	29	\$384,139.71
	7	\$1,294.63	3.00%	\$1,255.79		\$0.00
4 CY Dumpster	1	\$274.34	3.00%	\$266.11	2	\$6,386.61
	2	\$548.68	3.00%	\$532.22		\$0.00
	3	\$823.01	3.00%	\$798.32	1	\$9,579.79
	4	\$1,000.09	3.00%	\$970.08		\$0.00
	5	\$1,172.30	3.00%	\$1,137.13		\$0.00
	6	\$1,367.13	3.00%	\$1,326.12		\$0.00
	7	\$1,561.96	3.00%	\$1,515.10		\$0.00
6 CY Dumpster	1	\$350.72	3.00%	\$340.19		\$0.00
	2	\$701.43	3.00%	\$680.39		\$0.00
	3	\$1,052.16	3.00%	\$1,020.59		\$0.00
	4	\$1,305.61	3.00%	\$1,266.45		\$0.00
	5	\$1,554.21	3.00%	\$1,507.58		\$0.00
	6	\$1,825.41	3.00%	\$1,770.65		\$0.00
	7	\$2,096.62	3.00%	\$2,033.72		\$0.00
8 CY to 40 CY Roll-offs	1	\$220.00	3.00%	\$213.40	2	\$5,121.60
	2	\$440.00	3.00%	\$426.80		\$0.00
	3	\$660.00	3.00%	\$640.20		\$0.00
	4	\$880.00	3.00%	\$853.60		\$0.00
	5	\$1,100.00	3.00%	\$1,067.00		\$0.00
	6	\$1,320.00	3.00%	\$1,280.40		\$0.00
	7	\$1,540.00	3.00%	\$1,493.80		\$0.00
Compactor	1	\$250.00	3.00%	\$242.50		\$0.00
	2	\$500.00	3.00%	\$485.00		\$0.00
	3	\$750.00	3.00%	\$727.50		\$0.00
	4	\$1,000.00	3.00%	\$970.00		\$0.00
	5	\$1,250.00	3.00%	\$1,212.50		\$0.00
	6	\$1,500.00	3.00%	\$1,455.00		\$0.00
	7	\$1,750.00	3.00%	\$1,697.50		\$0.00
Total Proposed Annual Amount (3A)						\$1,306,221.02

Permanent Roll-Offs and Compactors: All 8, 10, 20, 30, 40 CY Roll-offs and compactors are pull rates only; total cost will be based on actual Disposal and/or Processing costs. Rates charged to Customers should include the total cost for pull, Processing and Disposal rates.

Temporary Roll-offs (Non-permanent service of no more than 30 consecutive days at Customer's site): Shall be charged as accordingly to the Service Rates indicated above and may charge an additional daily rental fee (See Extra Services Fees).

*Estimated No. of Collections per Week is based on 2019 Customer data submitted by the current non-exclusive commercial franchise waste haulers. Each of the Service Areas have different Customer counts.

Additional Entry: *(Proposer may use this space to add additional information such as additional facilities and if Proposer would like to add any additional service levels and Container sizes that may have not been identified above)*

The undersigned Proposer offers to perform the work described in the Request for Proposals (RFP) for the following price(s). The Proposer rate(s) (hourly, monthly, etc.) shall include all administrative costs, franchise fees, labor, supervision, overtime, materials, transportation, taxes, equipment, and supplies unless stated otherwise in the RFP. The Proposer understands and agrees that the quantities set forth in the Schedule of Prices by the County are only estimates and are based on current hauler submittals. Any unit prices quoted by the Proposer in this Schedule of Prices will apply to the actual quantities of work. The Proposer may use the estimates to develop its cost and rate proposal. The Proposer understands and agrees that each of the Service Areas have different Customer counts. County makes no representation or warranties of any kind, expressed or implied, as to the accuracy of the information set forth in the Schedule of Prices. County will not be liable for any damages or loss of any nature, including, but not limited to, lost profits, resulting from the estimates provided by the County. Proposer agrees to indemnify and hold the County harmless with respect to any issues, disputes, claims, lawsuits resulting from the estimates provided by the County in this solicitation, and in particular, as set forth in the Schedule of Prices. It is the responsibility of the proposer to undertake, at its sole cost, any verification of any and all information necessary for the preparation and submittal of a response to this RFP.

It is the County's sole discretion to select the collection method for each Service Area after receipt of all proposals. The County's selected collection method may not be the lowest cost collection method. The County may consider factors including but not limited to, cost per cubic yard, readiness to implement, regulatory compliance, and waste diversion potential, when deciding upon a collection method for each Service Area.

Instructions: Proposer shall enter proposed monthly rates in the blue boxes below. Proposer must submit a proposal/bid for each collection method: Three-Container, Two-Container and One-Container collection methods. Failure to do so may result in the proposal/bid being rejected as nonresponsive. All proposers should include the 14% franchise fee in their proposed rates. Proposers shall not change the numbers in Column D- Estimated No. of Collections per Week. Column E will auto calculate the Proposed Annual Amount for each service. The Proposed Total Annual Amounts for Collection Services of the County selected collection method will be used for the evaluation evaluated. Proposer is responsible for ensuring accuracy of calculations.

If Proposer does not currently offer the One-Container and Two-Container collection methods, Proposer shall input rates utilizing the facility tipping fee of a potential development of a High Diversion Organic Waste Processing Facility (HDOWPF) located in South Gate which will process Mixed Waste (Refuse and Organic Waste) at \$105 per ton,-- OR -- another High Diversion Organic Waste Processing Facility of Proposer's choosing with a reasonably similar tipping fee, location, and diversion rate that is in compliance with SB 1383 regulations as defined in 14 CCR Section 18982(a)(33). Proposer may also include in their proposal, an option to provide One-Container or Two-Container Collection Services for select Customers so long as the Proposer's proposal indicates how the results would provide similar diversion and cost effectiveness.

Residential Mixed Waste Processing Collection Services (Two-Container A- Gray & Blue Containers)

Gray Container: Allows for the collection of Organic Waste, such as food waste and yard waste, and Refuse.

Blue Container: Limited to traditional Non-Organic Recyclables, such as bottles, and cans, and Organic Waste, such as paper and cardboard.

Note: The following rates apply to Residential Customers for collecting Recyclables in the blue container.

Processing Facility Name: GRAND CENTRAL
 Processing Material(s): RECY Rate (Per Ton) 50

Service Description	Collection Frequency (No. of Pickups per Week)	Monthly Unit Price/Rate	(Discount Rate 3%)	Monthly Unit Price/Rate (Final Discounted Rate)	Estimated No. of Collections per Week	Annual Amount (Discounted Monthly Unit Price/Rate x Estimated No. of Collections per Week x 12)
32-Gallon Cart	1	\$21.90	3.00%	\$21.25		\$0.00
	2	\$52.98	3.00%	\$51.39		\$0.00
	3	\$61.90	3.00%	\$60.04		\$0.00
	4	\$69.34	3.00%	\$67.26		\$0.00
	5	\$76.80	3.00%	\$74.49		\$0.00
	6	\$80.29	3.00%	\$77.88		\$0.00
	7	\$83.79	3.00%	\$81.28		\$0.00
64-Gallon Cart	1	\$22.81	3.00%	\$22.12	1	\$265.46
	2	\$54.79	3.00%	\$53.15		\$0.00
	3	\$64.60	3.00%	\$62.66		\$0.00
	4	\$72.94	3.00%	\$70.76		\$0.00
	5	\$81.29	3.00%	\$78.85		\$0.00
	6	\$85.70	3.00%	\$83.13		\$0.00
	7	\$90.11	3.00%	\$87.41		\$0.00
96-Gallon Cart	1	\$23.70	3.00%	\$22.99	65	\$17,930.29
	2	\$66.43	3.00%	\$64.44		\$0.00
	3	\$82.07	3.00%	\$79.61		\$0.00
	4	\$96.24	3.00%	\$93.36		\$0.00
	5	\$110.41	3.00%	\$107.10		\$0.00
	6	\$120.63	3.00%	\$117.02		\$0.00
	7	\$130.86	3.00%	\$126.94		\$0.00
1 CY Dumpster	1	\$85.03	3.00%	\$82.48	179	\$177,156.59
	2	\$170.06	3.00%	\$164.96	28	\$55,426.71
	3	\$255.09	3.00%	\$247.44	3	\$8,907.68
	4	\$276.64	3.00%	\$268.34	10	\$32,200.64
	5	\$295.01	3.00%	\$286.16		\$0.00
	6	\$310.86	3.00%	\$301.53	29	\$104,934.17
	7	\$326.71	3.00%	\$316.91		\$0.00

1.5 CY Dumpster	1	\$87.87	3.00%	\$85.24	\$0.00
	2	\$175.74	3.00%	\$170.47	\$0.00
	3	\$263.61	3.00%	\$255.71	\$0.00
	4	\$288.01	3.00%	\$279.37	\$0.00
	5	\$309.22	3.00%	\$299.94	\$0.00
	6	\$327.90	3.00%	\$318.07	\$0.00
	7	\$346.58	3.00%	\$336.19	\$0.00
2 CY Dumpster	1	\$90.72	3.00%	\$88.00	\$0.00
	2	\$181.42	3.00%	\$175.98	\$0.00
	3	\$272.14	3.00%	\$263.98	\$0.00
	4	\$299.37	3.00%	\$290.39	\$0.00
	5	\$323.44	3.00%	\$313.73	\$0.00
	6	\$344.95	3.00%	\$334.61	\$0.00
	7	\$366.47	3.00%	\$355.48	\$0.00
3 CY Dumpster	1	\$96.40	3.00%	\$93.51	\$0.00
	2	\$192.79	3.00%	\$187.01	\$0.00
	3	\$289.18	3.00%	\$280.51	\$0.00
	4	\$322.10	3.00%	\$312.44	\$0.00
	5	\$351.85	3.00%	\$341.29	\$0.00
	6	\$379.06	3.00%	\$367.69	\$0.00
	7	\$406.27	3.00%	\$394.08	\$0.00
4 CY Dumpster	1	\$102.08	3.00%	\$99.02	\$0.00
	2	\$204.16	3.00%	\$198.03	\$0.00
	3	\$306.23	3.00%	\$297.05	\$0.00
	4	\$344.84	3.00%	\$334.49	\$0.00
	5	\$380.26	3.00%	\$368.86	\$0.00
	6	\$413.15	3.00%	\$400.76	\$0.00
	7	\$446.04	3.00%	\$432.66	\$0.00
6 CY Dumpster	1	\$113.45	3.00%	\$110.05	\$0.00
	2	\$226.89	3.00%	\$220.08	\$0.00
	3	\$340.34	3.00%	\$330.13	\$0.00
	4	\$390.30	3.00%	\$378.59	\$0.00
	5	\$437.10	3.00%	\$423.99	\$0.00
	6	\$481.35	3.00%	\$466.91	\$0.00
	7	\$525.60	3.00%	\$509.83	\$0.00
8 CY to 40 CY Roll-offs	1	\$220.00	3.00%	\$213.40	\$5,121.60
	2	\$440.00	3.00%	\$426.80	\$0.00
	3	\$660.00	3.00%	\$640.20	\$0.00
	4	\$880.00	3.00%	\$853.60	\$0.00
	5	\$1,100.00	3.00%	\$1,067.00	\$0.00
	6	\$1,320.00	3.00%	\$1,280.40	\$0.00
	7	\$1,540.00	3.00%	\$1,493.80	\$0.00
Compactor	1	\$250.00	3.00%	\$242.50	\$0.00
	2	\$500.00	3.00%	\$485.00	\$0.00
	3	\$750.00	3.00%	\$727.50	\$0.00
	4	\$1,000.00	3.00%	\$970.00	\$0.00
	5	\$1,250.00	3.00%	\$1,212.50	\$0.00
	6	\$1,500.00	3.00%	\$1,455.00	\$0.00
	7	\$1,750.00	3.00%	\$1,697.50	\$0.00
Total Proposed Annual Amount (3B)					\$401,943.15

Permanent Roll-Offs and Compactors: All 8, 10, 20, 30, 40 CY Roll-offs and compactors are pull rates only; total cost will be based on actual Disposal and/or Processing costs. Rates charged to Customers should include the total cost for pull, Processing and Disposal rates.
Temporary Roll-offs (Non-permanent service of no more than 30 consecutive days at Customer's site): Shall be charged as accordingly to the Service Rates indicated above and may charge an additional daily rental fee (See Extra Services Fees).

*Estimated No. of Collections per Week is based on 2019 Customer data submitted by the current non-exclusive commercial franchise waste haulers. Each of the Service Areas have different Customer counts.

Additional Entry: (Proposer may use this space to add additional information such as additional facilities and if Proposer would like to add any additional service levels and Container sizes that may have not been identified above)

The undersigned Proposer offers to perform the work described in the Request for Proposals (RFP) for the following price(s). The Proposer rate(s) (hourly, monthly, etc.) shall include all administrative costs, franchise fees, labor, supervision, overtime, materials, transportation, taxes, equipment, and supplies unless stated otherwise in the RFP. The Proposer understands and agrees that the quantities set forth in the Schedule of Prices by the County are only estimates based on current hauler submittals. Any unit prices quoted by the Proposer in this Schedule of Prices will apply to the actual quantities of work. The Proposer may use the estimates to develop its cost and rate proposal. The Proposer understands and agrees that each of the Service Areas have different Customer counts. County makes no representation or warranties of any kind, expressed or implied, as to the accuracy of the information set forth in the Schedule of Prices. County will not be liable for any damages or loss of any nature, including, but not limited to, lost profits, resulting from the estimates provided by the County. Proposer agrees to indemnify and hold the County harmless with respect to any issues, disputes, claims, lawsuits resulting from the estimates provided by the County in this solicitation, and in particular, as set forth in the Schedule of Prices. It is the responsibility of the proposer to undertake, at its sole cost, any verification of any and all information necessary for the preparation and submittal of a response to this RFP.

It is the County's sole discretion to select the collection method for each Service Area after receipt of all proposals. The County's selected collection method may not be the lowest cost collection method. The County may consider factors including but not limited to, cost per cubic yard, readiness to implement, regulatory compliance, and waste diversion potential, when deciding upon a collection method for each Service Area.

Instructions: Proposer shall enter proposed monthly rates in the blue boxes below. Proposer must submit a proposal/bid for each collection method: Three-Container, Two-Container and One-Container collection methods. Failure to do so may result in the proposal/bid being rejected as nonresponsive. All proposers should include the 14% franchise fee in their proposed rates. Proposers shall not change the numbers in Column D- Estimated No. of Collections per Week. Column E will auto calculate the Proposed Annual Amount for each service. The Proposed Total Annual Amounts for Collection Services of the County selected collection method will be used for the evaluation evaluated. Proposer is responsible for ensuring accuracy of calculations.

If Proposer does not currently offer the One-Container and Two-Container collection methods, Proposer shall input rates utilizing the facility tipping fee of a potential development of a High Diversion Organic Waste Processing Facility (HDOWPF) located in South Gate which will process Mixed Waste (Refuse and Organic Waste) at \$105 per ton, – OR – another High Diversion Organic Waste Processing Facility of Proposer's choosing with a reasonably similar tipping fee, location, and diversion rate that is in compliance with SB 1383 regulations as defined in 14 CCR Section 18982(a)(33). Proposer may also include in their proposal, an option to provide One-Container or Two-Container Collection Services for select Customers so long as the Proposer's proposal indicates how the results would provide similar diversion and cost effectiveness.

Residential Mixed Waste Processing Collection Services (Two-Container B- Gray & Green Containers)

Gray Container: Allows for the collection of intentional commingled wastes including Organic Waste (paper, cardboard) and Non-Organic Recyclables (bottles and cans), and Refuse.

Green Container: Limited to only Organic Waste sent to a source separated organics facility. This includes food waste and yard waste.

Note: The following rates apply to Residential Customers for collecting all commingled wastes & Non-Organic Recyclables in the **gray container**.

Processing Facility Name: GRAND CENTRAL RECYCLING AND TRANSFER

Processing Material(s): MSW/REC Rate (Per Ton) \$77.84

Service Description	Collection Frequency (No. of Pickups per Week)	Monthly Unit Price/Rate	(Discount Rate 3%)	Monthly Unit Price/Rate (Final Discounted Rate)	*Estimated No. of Collections per Week	Annual Amount (Discounted Monthly Unit Price/Rate x Estimated No. of Collections per Week x 12)
32-Gallon Cart	1	\$33.16	3.00%	\$32.17		\$0.00
	2	\$54.96	3.00%	\$53.31		\$0.00
	3	\$74.39	3.00%	\$72.16		\$0.00
	4	\$93.15	3.00%	\$90.36		\$0.00
	5	\$111.91	3.00%	\$108.55		\$0.00
	6	\$128.87	3.00%	\$125.00		\$0.00
	7	\$145.82	3.00%	\$141.45		\$0.00
64-Gallon Cart	1	\$37.58	3.00%	\$36.45		\$0.00
	2	\$62.29	3.00%	\$60.42		\$0.00
	3	\$84.31	3.00%	\$81.78		\$0.00
	4	\$105.56	3.00%	\$102.39		\$0.00
	5	\$126.83	3.00%	\$123.03		\$0.00
	6	\$146.05	3.00%	\$141.67		\$0.00
	7	\$165.26	3.00%	\$160.30		\$0.00
96-Gallon Cart	1	\$44.22	3.00%	\$42.89		\$0.00
	2	\$73.28	3.00%	\$71.08		\$0.00
	3	\$99.18	3.00%	\$96.20		\$0.00
	4	\$124.19	3.00%	\$120.46		\$0.00
	5	\$149.22	3.00%	\$144.74		\$0.00
	6	\$171.82	3.00%	\$166.67		\$0.00
	7	\$194.43	3.00%	\$188.60		\$0.00
1 CY Dumpster	1	\$108.27	3.00%	\$105.02	1	\$1,260.26
	2	\$216.52	3.00%	\$210.02		\$0.00
	3	\$324.79	3.00%	\$315.05		\$0.00
	4	\$361.17	3.00%	\$350.33		\$0.00
	5	\$393.94	3.00%	\$382.12		\$0.00
	6	\$443.44	3.00%	\$430.14		\$0.00
	7	\$492.93	3.00%	\$478.14		\$0.00

1.5 CY Dumpster	1	\$117.46	3.00%	\$113.94	28	\$38,282.56
	2	\$234.93	3.00%	\$227.88		\$0.00
	3	\$352.39	3.00%	\$341.82		\$0.00
	4	\$397.97	3.00%	\$386.03		\$0.00
	5	\$439.95	3.00%	\$426.75		\$0.00
	6	\$498.65	3.00%	\$483.69		\$0.00
	7	\$557.34	3.00%	\$540.62		\$0.00
2 CY Dumpster	1	\$126.66	3.00%	\$122.86	37	\$54,549.93
	2	\$253.33	3.00%	\$245.73		\$0.00
	3	\$380.00	3.00%	\$368.60		\$0.00
	4	\$434.77	3.00%	\$421.73		\$0.00
	5	\$485.95	3.00%	\$471.37		\$0.00
	6	\$553.85	3.00%	\$537.23		\$0.00
	7	\$621.76	3.00%	\$603.11		\$0.00
3 CY Dumpster	1	\$145.07	3.00%	\$140.72	177	\$298,884.82
	2	\$290.14	3.00%	\$281.44	28	\$94,562.43
	3	\$435.20	3.00%	\$422.14	2	\$10,131.46
	4	\$508.39	3.00%	\$493.14	10	\$59,176.60
	5	\$577.97	3.00%	\$560.63		\$0.00
	6	\$664.27	3.00%	\$644.34	29	\$224,230.98
	7	\$750.57	3.00%	\$728.05		\$0.00
4 CY Dumpster	1	\$163.47	3.00%	\$158.57	2	\$3,805.58
	2	\$326.94	3.00%	\$317.13		\$0.00
	3	\$490.41	3.00%	\$475.70	1	\$5,708.37
	4	\$581.99	3.00%	\$564.53		\$0.00
	5	\$669.98	3.00%	\$649.88		\$0.00
	6	\$774.68	3.00%	\$751.44		\$0.00
	7	\$879.38	3.00%	\$853.00		\$0.00
6 CY Dumpster	1	\$200.28	3.00%	\$194.27		\$0.00
	2	\$400.55	3.00%	\$388.53		\$0.00
	3	\$600.83	3.00%	\$582.81		\$0.00
	4	\$729.21	3.00%	\$707.33		\$0.00
	5	\$854.01	3.00%	\$828.39		\$0.00
	6	\$995.52	3.00%	\$965.65		\$0.00
	7	\$1,137.03	3.00%	\$1,102.92		\$0.00
8 CY to 40 CY Roll-offs	1	\$220.00	3.00%	\$213.40	2	\$5,121.60
	2	\$440.00	3.00%	\$426.80		\$0.00
	3	\$660.00	3.00%	\$640.20		\$0.00
	4	\$880.00	3.00%	\$853.60		\$0.00
	5	\$1,100.00	3.00%	\$1,067.00		\$0.00
	6	\$1,320.00	3.00%	\$1,280.40		\$0.00
	7	\$1,540.00	3.00%	\$1,493.80		\$0.00
Compactor	1	\$250.00	3.00%	\$242.50		\$0.00
	2	\$500.00	3.00%	\$485.00		\$0.00
	3	\$750.00	3.00%	\$727.50		\$0.00
	4	\$1,000.00	3.00%	\$970.00		\$0.00
	5	\$1,250.00	3.00%	\$1,212.50		\$0.00
	6	\$1,500.00	3.00%	\$1,455.00		\$0.00
	7	\$1,750.00	3.00%	\$1,697.50		\$0.00
Total Proposed Annual Amount (3C)						\$795,714.59
Permanent Roll-Offs and Compactors: All 8, 10, 20, 30, 40 CY Roll-offs and compactors are pull rates only; total cost will be based on actual Disposal and/or Processing costs. Rates charged to Customers should include the total cost for pull, Processing and Disposal rates. Temporary Roll-offs (Non-permanent service of no more than 30 consecutive days at Customer's site): Shall be charged as accordingly to the Service Rates indicated above and may charge an additional daily rental fee (See Extra Services Fees).						

*Estimated No. of Collections per Week is based on 2019 Customer data submitted by the current non-exclusive commercial franchise waste haulers. Each of the Service Areas have different Customer counts.

Additional Entry: (Proposer may use this space to add additional information such as additional facilities and if Proposer would like to add any additional service levels and Container sizes that may have not been identified above) **TEMP ROLLOFF \$538.00 PER TON \$77.84**

The undersigned Proposer offers to perform the work described in the Request for Proposals (RFP) for the following price(s). The Proposer rate(s) (hourly, monthly, etc.) shall include all administrative costs, franchise fees, labor, supervision, overtime, materials, transportation, taxes, equipment, and supplies unless stated otherwise in the RFP. The Proposer understands and agrees that the quantities set forth in the Schedule of Prices by the County are only estimates based on current hauler submittals. Any unit prices quoted by the Proposer in this Schedule of Prices will apply to the actual quantities of work. The Proposer may use the estimates to develop its cost and rate proposal. The Proposer understands and agrees that each of the Service Areas have different Customer counts. County makes no representation or warranties of any kind, expressed or implied, as to the accuracy of the information set forth in the Schedule of Prices. County will not be liable for any damages or loss of any nature, including, but not limited to, lost profits, resulting from the estimates provided by the County. Proposer agrees to indemnify and hold the County harmless with respect to any issues, disputes, claims, lawsuits resulting from the estimates provided by the County in this solicitation, and in particular, as set forth in the Schedule of Prices. It is the responsibility of the proposer to undertake, at its sole cost, any verification of any and all information necessary for the preparation and submittal of a response to this RFP.

It is the County's sole discretion to select the collection method for each Service Area after receipt of all proposals. The County's selected collection method may not be the lowest cost collection method. The County may consider factors including but not limited to, cost per cubic yard, readiness to implement, regulatory compliance, and waste diversion potential, when deciding upon a collection method for each Service Area.

Instructions: Proposer shall enter proposed monthly rates in the blue boxes below. Proposer must submit a proposal/bid for each collection method: Three-Container, Two-Container and One-Container collection methods. Failure to do so may result in the proposal/bid being rejected as nonresponsive. All proposers should include the 14% franchise fee in their proposed rates. Proposers shall not change the numbers in Column D- Estimated No. of Collections per Week. Column E will auto calculate the Proposed Annual Amount for each service. The Proposed Total Annual Amounts for Collection Services of the County selected collection method will be used for the evaluation evaluated. Proposer is responsible for ensuring accuracy of calculations.

If Proposer does not currently offer the One-Container and Two-Container collection methods, Proposer shall input rates utilizing the facility tipping fee of a potential development of a High Diversion Organic Waste Processing Facility (HDOWPF) located in South Gate which will process Mixed Waste (Refuse and Organic Waste) at \$105 per ton, – OR – another High Diversion Organic Waste Processing Facility of Proposer's choosing with a reasonably similar tipping fee, location, and diversion rate that is in compliance with SB 1383 regulations as defined in 14 CCR Section 18982(a)(33). Proposer may also include in their proposal, an option to provide One-Container or Two-Container Collection Services for select Customers so long as the Proposer's proposal indicates how the results would provide similar diversion and cost effectiveness.

Residential Mixed Waste Processing Collection Services (Two-Container B- Gray & Green Containers)

Gray Container: Allows for the collection of intentional commingled wastes including Organic Waste (paper, cardboard) and Non-Organic Recyclables (bottles and cans), and Refuse.

Green Container: Limited to only Organic Waste sent to a source separated organics facility. This includes food waste and yard waste.

Note: The following rates apply to Residential Customers for collecting Organic Waste in the **green container**.

Processing Facility Name: GRAND CENTRAL RECYCLING AND TRANSFER

Processing Material(s): ORG/YARD Rate (Per Ton) \$105.00

Service Description	Collection Frequency (No. of Pickups per Week)	Monthly Unit Price/Rate	(Discount Rate 3%)	Monthly Unit Price/Rate (Final Discounted Rate)	*Estimated No. of Collections per Week	Annual Amount (Discounted Monthly Unit Price/Rate x Estimated No. of Collections per Week x 12)
32-Gallon Cart	1	\$49.91	3.00%	\$48.41		\$0.00
	2	\$99.81	3.00%	\$96.82		\$0.00
	3	\$149.71	3.00%	\$145.22		\$0.00
	4	\$199.61	3.00%	\$193.63		\$0.00
	5	\$249.52	3.00%	\$242.04		\$0.00
	6	\$299.42	3.00%	\$290.44		\$0.00
	7	\$349.33	3.00%	\$338.85		\$0.00
64-Gallon Cart	1	\$56.56	3.00%	\$54.87	29	\$19,093.13
	2	\$113.12	3.00%	\$109.72		\$0.00
	3	\$169.67	3.00%	\$164.58		\$0.00
	4	\$226.23	3.00%	\$219.44		\$0.00
	5	\$282.79	3.00%	\$274.31		\$0.00
	6	\$339.35	3.00%	\$329.17		\$0.00
	7	\$395.90	3.00%	\$384.02		\$0.00
96-Gallon Cart	1	\$66.54	3.00%	\$64.55	37	\$28,659.06
	2	\$133.08	3.00%	\$129.09		\$0.00
	3	\$199.62	3.00%	\$193.63		\$0.00
	4	\$266.15	3.00%	\$258.17		\$0.00
	5	\$332.70	3.00%	\$322.71		\$0.00
	6	\$399.23	3.00%	\$387.25		\$0.00
	7	\$465.77	3.00%	\$451.79		\$0.00
1 CY Dumpster	1	\$108.96	3.00%	\$105.69	179	\$227,024.70
	2	\$217.91	3.00%	\$211.37	28	\$71,021.23
	3	\$326.87	3.00%	\$317.06	3	\$11,414.30
	4	\$363.93	3.00%	\$353.01	10	\$42,361.45
	5	\$397.40	3.00%	\$385.48		\$0.00
	6	\$447.59	3.00%	\$434.16	29	\$151,088.48
	7	\$497.79	3.00%	\$482.86		\$0.00

1.5 CY Dumpster	1	\$118.50	3.00%	\$114.95		\$0.00
	2	\$237.01	3.00%	\$229.90		\$0.00
	3	\$355.51	3.00%	\$344.84		\$0.00
	4	\$402.13	3.00%	\$390.07		\$0.00
	5	\$445.15	3.00%	\$431.80		\$0.00
	6	\$504.87	3.00%	\$489.72		\$0.00
	7	\$564.60	3.00%	\$547.66		\$0.00
2 CY Dumpster	1	\$128.05	3.00%	\$124.21		\$0.00
	2	\$256.10	3.00%	\$248.42		\$0.00
	3	\$384.15	3.00%	\$372.63		\$0.00
	4	\$440.31	3.00%	\$427.10		\$0.00
	5	\$492.88	3.00%	\$478.09		\$0.00
	6	\$562.16	3.00%	\$545.30		\$0.00
	7	\$631.44	3.00%	\$612.50		\$0.00
3 CY Dumpster	1	\$147.15	3.00%	\$142.74		\$0.00
	2	\$294.29	3.00%	\$285.46		\$0.00
	3	\$441.43	3.00%	\$428.19		\$0.00
	4	\$516.69	3.00%	\$501.19		\$0.00
	5	\$588.36	3.00%	\$570.71		\$0.00
	6	\$676.74	3.00%	\$656.44		\$0.00
	7	\$765.12	3.00%	\$742.17		\$0.00
4 CY Dumpster	1	\$166.24	3.00%	\$161.25		\$0.00
	2	\$332.48	3.00%	\$322.51		\$0.00
	3	\$498.72	3.00%	\$483.76		\$0.00
	4	\$593.08	3.00%	\$575.29		\$0.00
	5	\$683.83	3.00%	\$663.32		\$0.00
	6	\$791.30	3.00%	\$767.56		\$0.00
	7	\$898.77	3.00%	\$871.81		\$0.00
6 CY Dumpster	1	\$204.44	3.00%	\$198.31		\$0.00
	2	\$408.86	3.00%	\$396.59		\$0.00
	3	\$613.30	3.00%	\$594.90		\$0.00
	4	\$745.83	3.00%	\$723.46		\$0.00
	5	\$874.79	3.00%	\$848.55		\$0.00
	6	\$1,020.45	3.00%	\$989.84		\$0.00
	7	\$1,166.12	3.00%	\$1,131.14		\$0.00
8 CY to 40 CY Roll-offs	1	\$220.00	3.00%	\$213.40	2	\$5,121.60
	2	\$440.00	3.00%	\$426.80		\$0.00
	3	\$660.00	3.00%	\$640.20		\$0.00
	4	\$880.00	3.00%	\$853.60		\$0.00
	5	\$1,100.00	3.00%	\$1,067.00		\$0.00
	6	\$1,320.00	3.00%	\$1,280.40		\$0.00
	7	\$1,540.00	3.00%	\$1,493.80		\$0.00
Compactor	1	\$250.00	3.00%	\$242.50		\$0.00
	2	\$500.00	3.00%	\$485.00		\$0.00
	3	\$750.00	3.00%	\$727.50		\$0.00
	4	\$1,000.00	3.00%	\$970.00		\$0.00
	5	\$1,250.00	3.00%	\$1,212.50		\$0.00
	6	\$1,500.00	3.00%	\$1,455.00		\$0.00
	7	\$1,750.00	3.00%	\$1,697.50		\$0.00
Total Proposed Annual Amount (3D)						\$555,783.95

Permanent Roll-Offs and Compactors: All 8, 10, 20, 30, 40 CY Roll-offs and compactors are pull rates only; total cost will be based on actual Disposal and/or Processing costs. Rates charged to Customers should include the total cost for pull, Processing and Disposal rates.
Temporary Roll-offs (Non-permanent service of no more than 30 consecutive days at Customer's site): Shall be charged as accordingly to the Service Rates indicated above and may charge an additional daily rental fee (See Extra Services Fees).

*Estimated No. of Collections per Week is based on 2019 Customer data submitted by the current non-exclusive commercial franchise waste haulers. Each of the Service Areas have different Customer counts.

Additional Entry: (Proposer may use this space to add additional information such as additional facilities and if Proposer would like to add any additional service levels and Container sizes that may have not been identified above) **TEMP ROLLOFF \$538.00 PER TON \$77.84**

The undersigned Proposer offers to perform the work described in the Request for Proposals (RFP) for the following price(s). The Proposer rate(s) (hourly, monthly, etc.) shall include all administrative costs, franchise fees, labor, supervision, overtime, materials, transportation, taxes, equipment, and supplies unless stated otherwise in the RFP. The Proposer understands and agrees that the quantities set forth in the Schedule of Prices by the County are only estimates are based on current hauler submittals. Any unit prices quoted by the Proposer in this Schedule of Prices will apply to the actual quantities of work. The Proposer may use the estimates to develop its cost and rate proposal. The Proposer understands and agrees that each of the Service Areas have different Customer counts. County makes no representation or warranties of any kind, expressed or implied, as to the accuracy of the information set forth in the Schedule of Prices. County will not be liable for any damages or loss of any nature, including, but not limited to, lost profits, resulting from the estimates provided by the County. Proposer agrees to indemnify and hold the County harmless with respect to any issues, disputes, claims, lawsuits resulting from the estimates provided by the County in this solicitation, and in particular, as set forth in the Schedule of Prices. It is the responsibility of the proposer to undertake, at its sole cost, any verification of any and all information necessary for the preparation and submittal of a response to this RFP.

It is the County's sole discretion to select the collection method for each Service Area after receipt of all proposals. The County's selected collection method may not be the lowest cost collection method. The County may consider factors including but not limited to, cost per cubic yard, readiness to implement, regulatory compliance, and waste diversion potential, when deciding upon a collection method for each Service Area.

Instructions: Proposer shall enter proposed monthly rates in the blue boxes below. Proposer must submit a proposal/bid for each collection method: Three-Container, Two-Container and One-Container collection methods. Failure to do so may result in the proposal/bid being rejected as nonresponsive. All proposers should include the 14% franchise fee in their proposed rates. Proposers shall not change the numbers in Column D- Estimated No. of Collections per Week. Column E will auto calculate the Proposed Annual Amount for each service. The Proposed Total Annual Amounts for Collection Services of the County selected collection method will be used for the evaluation evaluated. Proposer is responsible for ensuring accuracy of calculations.

If Proposer does not currently offer the One-Container and Two-Container collection methods, Proposer shall input rates utilizing the facility tipping fee of a potential development of a High Diversion Organic Waste Processing Facility (HDOWPF) located in South Gate which will process Mixed Waste (Refuse and Organic Waste) at \$105 per ton, – OR – another High Diversion Organic Waste Processing Facility of Proposer's choosing with a reasonably similar tipping fee, location, and diversion rate that is in compliance with SB 1383 regulations as defined in 14 CCR Section 18982(a)(33). Proposer may also include in their proposal, an option to provide One-Container or Two-Container Collection Services for select Customers so long as the Proposer's proposal indicates how the results would provide similar diversion and cost effectiveness.

Residential Mixed Waste Processing Collection Services (One-Container)

Note: The following rates apply to Residential Customers for collecting Refuse, Recycling and Organic Waste materials into a single gray container.

Processing Facility Name: **SOUTH GATE**

Processing Material(s): **MSW/REC/ORG/YARD Rate (Per Ton) \$105.00**

Service Description	Collection Frequency (No. of Pickups per Week)	Monthly Unit Price/Rate	(Discount Rate 3%)	Monthly Unit Price/Rate (Final Discounted Rate)	*Estimated No. of Collections per Week	Annual Amount (Discounted Monthly Unit Price/Rate x Estimated No. of Collections per Week x 12)
32-Gallon Cart	1	\$33.16	3.00%	\$32.17		\$0.00
	2	\$54.96	3.00%	\$53.31		\$0.00
	3	\$74.39	3.00%	\$72.16		\$0.00
	4	\$93.15	3.00%	\$90.36		\$0.00
	5	\$111.91	3.00%	\$108.55		\$0.00
	6	\$128.87	3.00%	\$125.00		\$0.00
	7	\$145.82	3.00%	\$141.45		\$0.00
64-Gallon Cart	1	\$37.58	3.00%	\$36.45		\$0.00
	2	\$62.29	3.00%	\$60.42		\$0.00
	3	\$84.31	3.00%	\$81.78		\$0.00
	4	\$105.56	3.00%	\$102.39		\$0.00
	5	\$126.83	3.00%	\$123.03		\$0.00
	6	\$146.05	3.00%	\$141.67		\$0.00
	7	\$165.26	3.00%	\$160.30		\$0.00
96-Gallon Cart	1	\$44.22	3.00%	\$42.89		\$0.00
	2	\$73.28	3.00%	\$71.08		\$0.00
	3	\$99.18	3.00%	\$96.20		\$0.00
	4	\$124.19	3.00%	\$120.46		\$0.00
	5	\$149.22	3.00%	\$144.74		\$0.00
	6	\$171.82	3.00%	\$166.67		\$0.00
	7	\$194.43	3.00%	\$188.60		\$0.00
1 CY Dumpster	1	\$114.68	3.00%	\$111.24	1	\$1,334.88
	2	\$229.36	3.00%	\$222.48		\$0.00
	3	\$344.05	3.00%	\$333.73		\$0.00
	4	\$386.85	3.00%	\$375.24		\$0.00
	5	\$426.05	3.00%	\$413.27		\$0.00
	6	\$481.96	3.00%	\$467.50		\$0.00
	7	\$537.87	3.00%	\$521.73		\$0.00

1.5 CY Dumpster	1	\$127.09	3.00%	\$123.28	28	\$41,421.17
	2	\$254.20	3.00%	\$246.57		\$0.00
	3	\$381.29	3.00%	\$369.85		\$0.00
	4	\$436.49	3.00%	\$423.40		\$0.00
	5	\$488.10	3.00%	\$473.46		\$0.00
	6	\$556.44	3.00%	\$539.75		\$0.00
	7	\$624.77	3.00%	\$606.03		\$0.00
2 CY Dumpster	1	\$139.50	3.00%	\$135.32	37	\$60,079.86
	2	\$279.02	3.00%	\$270.65		\$0.00
	3	\$418.52	3.00%	\$405.96		\$0.00
	4	\$486.14	3.00%	\$471.56		\$0.00
	5	\$550.17	3.00%	\$533.66		\$0.00
	6	\$630.90	3.00%	\$611.97		\$0.00
	7	\$711.64	3.00%	\$690.29		\$0.00
3 CY Dumpster	1	\$164.34	3.00%	\$159.41	177	\$338,586.42
	2	\$328.66	3.00%	\$318.80	28	\$107,116.87
	3	\$493.00	3.00%	\$478.21	2	\$11,477.04
	4	\$585.43	3.00%	\$567.87	10	\$68,144.05
	5	\$674.29	3.00%	\$654.06		\$0.00
	6	\$779.85	3.00%	\$756.45	29	\$263,246.17
	7	\$885.40	3.00%	\$858.84		\$0.00
4 CY Dumpster	1	\$189.16	3.00%	\$183.49	2	\$4,403.64
	2	\$378.31	3.00%	\$366.96		\$0.00
	3	\$567.46	3.00%	\$550.44	1	\$6,605.23
	4	\$684.73	3.00%	\$664.19		\$0.00
	5	\$798.41	3.00%	\$774.46		\$0.00
	6	\$928.79	3.00%	\$900.93		\$0.00
	7	\$1,059.17	3.00%	\$1,027.39		\$0.00
6 CY Dumpster	1	\$238.80	3.00%	\$231.64		\$0.00
	2	\$477.60	3.00%	\$463.27		\$0.00
	3	\$716.41	3.00%	\$694.92		\$0.00
	4	\$883.32	3.00%	\$856.82		\$0.00
	5	\$1,046.64	3.00%	\$1,015.24		\$0.00
	6	\$1,226.67	3.00%	\$1,189.87		\$0.00
	7	\$1,406.71	3.00%	\$1,364.51		\$0.00
8 CY to 40 CY Roll-offs	1	\$220.00	3.00%	\$213.40	2	\$5,121.60
	2	\$440.00	3.00%	\$426.80		\$0.00
	3	\$660.00	3.00%	\$640.20		\$0.00
	4	\$880.00	3.00%	\$853.60		\$0.00
	5	\$1,100.00	3.00%	\$1,067.00		\$0.00
	6	\$1,320.00	3.00%	\$1,280.40		\$0.00
	7	\$1,540.00	3.00%	\$1,493.80		\$0.00
Compactor	1	\$250.00	3.00%	\$242.50		\$0.00
	2	\$500.00	3.00%	\$485.00		\$0.00
	3	\$750.00	3.00%	\$727.50		\$0.00
	4	\$1,000.00	3.00%	\$970.00		\$0.00
	5	\$1,250.00	3.00%	\$1,212.50		\$0.00
	6	\$1,500.00	3.00%	\$1,455.00		\$0.00
	7	\$1,750.00	3.00%	\$1,697.50		\$0.00
Total Proposed Annual Amount (3E)						\$907,536.93

Permanent Roll-Offs and Compactors: All 8, 10, 20, 30, 40 CY Roll-offs and compactors are pull rates only; total cost will be based on actual Disposal and/or Processing costs. Rates charged to Customers should include the total cost for pull, Processing and Disposal rates.

Temporary Roll-offs (Non-permanent service of no more than 30 consecutive days at Customer's site): Shall be charged as accordingly to the Service Rates indicated above and may charge an additional daily rental fee (See Extra Services Fees).

*Estimated No. of Collections per Week is based on 2019 Customer data submitted by the current non-exclusive commercial franchise waste haulers. Each of the Service Areas have different Customer counts.

Additional Entry: (Proposer may use this space to add additional information such as additional facilities and if Proposer would like to add any additional service levels and Container sizes that may have not been identified above)

Rates Summary

Note: The Total Proposed Annual Amounts from all the proposal rate sheets for Mixed Waste Processing Collection Services rates will be automatically calculated into the table below. Proposer is responsible for ensuring accuracy of calculations. Proposer must fill and sign the signature block acknowledgement below upon confirming calculations.

Title	Proposed Total Annual Amounts
Commercial Mixed Waste Processing Collection Services Rates Two-Container A: Gray and Blue Containers (1A+1B)	\$5,902,640.78
Multifamily Mixed Waste Processing Collection Services Rates Two-Container A: Gray and Blue Containers (2A+2B)	\$2,348,173.37
Residential Mixed Waste Processing Collection Services Rates Two-Container A: Gray and Blue Containers (3A+3B)	\$1,708,164.18
Total Proposed Annual Amount for Two-Container A: Gray and Blue Containers (Total Proposed Annual Amounts of 1A+1B+2A+2B+3A+3B)	\$9,958,978.33
Commercial Mixed Waste Processing Collection Services Rates Two-Container B: Gray and Green Containers (1C+1D)	\$4,614,059.73
Multifamily Mixed Waste Processing Collection Services Rates Two-Container B: Gray and Green Containers (2C+2D)	\$1,836,432.51
Residential Mixed Waste Processing Collection Services Rates Two-Container B: Gray and Green Containers (3C+3D)	\$1,351,498.54
Total Proposed Annual Amount for Two-Container B: Gray and Green Containers (Total Proposed Annual Amounts of 1C+1D+2C+2D+3C+3D)	\$7,801,990.78
Commercial Mixed Waste Processing Collection Services Rates One-Container: Gray Container (Refuse, Recycling and Organic Waste) (1E)	\$3,014,729.39
Multifamily Mixed Waste Processing Collection Services Rates One-Container: Gray Container (Refuse, Recycling and Organic Waste) (2E)	\$1,201,572.99
Residential Mixed Waste Processing Collection Services Rates One-Container: Gray Container (Refuse, Recycling and Organic Waste) (3E)	\$907,536.93
Total Proposed Annual Amount for One-Container: Gray Container (Refuse, Recycling and Organic Waste) (Total Proposed Annual Amounts of 1E+2E+3E)	\$5,123,839.30

Signature Block Acknowledgement:

Legal Name of Proposer - VALLEY VISTA SERVICES, INC.	
Signature of Person Authorized to Submit Proposal	
Title of Authorized Person - SECRETARY	
Date 6-1-2022	State Contractor's License Number
Proposer's Address: 17445 EAST RAILROAD STREET CITY OF INDUSTRY CA 91748	
E-Mail - DAVIDPEREZ@ZEREPMANAGEMENT.COM	
Phone - 626-855-5555	Mobile

EXHIBIT 12-D2 – Liquidated Damages

Reference to "failure" refers to each occurrence of specified Breach (such as for each Occupant and each Occupant's Collection site, Record entry, or complaint) and not for aggregate occurrences of those Breaches (such as for all Customers and Occupants on a given route or day). Per day means each business day except as indicated.

If CONTRACTOR does not timely submit the applicable information, documentation or complete Report or incorporate comments, additions and corrections made by Director within five days of receipt of those comments, additions, and corrections, it shall pay the following liquidated damages.

No.	Section	Failure	Damage
1	Item D of Exhibit 3A1	Use of Solid Waste Facility(s) that are not Approved by the COUNTY	\$100 per ton
2	Item A1 of Exhibit 3A1	Failure to provide Collection Services and deliver appropriate Collection Containers for the Collection of Solid Waste (Refuse, Recyclables and Organic Waste) to each and every Customer within the CONTRACTOR's Service Area after Contract Execution Date (exception for customers who are exempt from Service)	\$200 per Customer per week
3	Item E 5 of Exhibit 3A1	Failure to Process Recyclables, or mixing Recyclables and/or Organic Waste with Refuse (exception for mixed waste collection which shall be sent to an approved HDOWPF)	\$1000 per Vehicle per occurrence
4	Item I of Section 4	Commingling materials from outside the Service Area with Solid Waste that CONTRACTOR Collects inside the Service Area, such as commingling Collected Solid Waste from Garbage Disposal Districts (GDD), incorporated cities or other counties with Solid Waste Collected from their Service Area.	\$500 per Vehicle per occurrence

5	Item J1 of Exhibit 3A1	Failure to Perform Contamination Monitoring Requirements	\$500 per hauler route for initial failure to conduct Contamination Monitoring plus \$100 per hauler route per day until contamination inspections are completed
6	Item C of Exhibit 3A1	Failure to Comply with Container Labeling and Colors requirements	\$100 per occurrence per Container
7	Item J2 of Exhibit 3A1 & Item D1e of Section 6	Failure to assist the COUNTY with SB 1383 related compliance tasks such as waivers, non-compliance complaints, and any other SB 1383 related requests not captured in any other category in this Exhibit 12-D2.	\$100 per occurrence
8	Section 13	Failure to follow Unpermitted Waste Screening Protocol and Reporting	\$500 per occurrence
9	Item 2 of Section 10	Failure to provide Route maps and schedules	\$100 per day
10	Item I of Exhibit 3A1	Failure to conduct site visits and waste assessments	\$300 per occurrence
11	Item A4 of Exhibit 3A1	Failure to Collect during authorized hours	\$250 per occurrence
12	Section 4	Failure to meet Service Standards for litter, spills, leaks and noise	\$150 per day
13	Item H of Section 4	Each failure during any calendar month to return Director calls, emails or to timely meet with COUNTY in accordance with Section 4H.	\$500 per occurrence
14	Item C5 of Exhibit 3A1	Failure to timely remove graffiti accordance with item C5 of Exhibit 3A1	\$100 per day
15	Item C8 of Exhibit 3A1	Failure to timely repair or replace Container(s) (upon Customer request)	\$500 per occurrence

16	Section 10	Failure to submit complete and correct information or Reports on time: (1) quarterly, (2) annually, (3) as required by any State Laws or County Code, or (4) any other time required under this CONTRACT.	Until corrected or completed: (1) \$200 per day (2) \$300 per day (3) \$150 per day (4) \$100 per day
17	Section 9	Failure to allow COUNTY to inspect, audit or copy Records	\$150 per requested record per occurrence
18	Item F of Section 4	Failure to provide documentation for COUNTY review or comment; or to obtain any COUNTY approval, consent or other permission	\$300 per day per occurrence or retraction/correction of misinformation
19	Item I of Exhibit 3A1	Failure to Perform Public Education and Outreach	\$100 per occurrence
20	Item I of Exhibit 3A1	Failure to timely provide Customer with Bill of Rights and/or Subscription Order Form	\$100 per day per customer per occurrence
21	Item B1 of Section 7	Itemizing the Franchise Fee on a Customer's invoice	\$100 per Customer per invoice
22	Item A5 of Exhibit 3A1	Failure to tag non-collected Solid Waste and keep a record of reason	\$150 per occurrence per day
23	Item D of Section 6	Failure to honor commitment to resolve a Customer's or Occupant's first complaint	\$100 per occurrence per day until resolution
24	Item D of Section 6	For each failure to honor commitment to resolve Customer's or Occupant's same complaint, which generated a second complaint	\$250 per occurrence per day until resolution
25	Item D of Section 6	For each failure to honor commitment to resolve Customer's or Occupant's same complaint, which generated a third or more complaint	\$500 for each subsequent complaint
26	Part 5C of Exhibit 5	Failure to repair damage caused to private property	\$150 per day until resolved

27	Item A4e of Exhibit 3A1	Missed Collection	\$100 per occurrence for each Container \$200 for each day thereafter
28	Section 1A	Collecting, removing, or transporting Solid Waste from Customers that are not within in CONTRACTOR's Service Area.	\$500 per verified occurrence
29	Section 3C	For each failure to maintain any Vehicle in accordance with Applicable Law	\$150 per Vehicle per day
30	Item C12 of Section 3	Failure to maintain and operate GPS equipment in working order	\$100 per Vehicle per day

By placing initials below at the places provided, each Party specifically confirms the accuracy of the statements made above and the fact that each Party has had many opportunities to consult with legal counsel and obtain an explanation of liquidated damage provisions of the time that this CONTRACT was made.

CONTRACTOR
Initial Here: DMW

COUNTY
Initial Here: CS

Intentionally left blank

EXHIBIT 16 – Contract Service Area Information

- A. Maps
- B. Service Areas Data Information
- C. Outreach

16.A.1- Map of Exclusive Commercial Franchise Service Areas



EXCLUSIVE COMMERCIAL FRANCHISE AGREEMENT SERVICE AREA

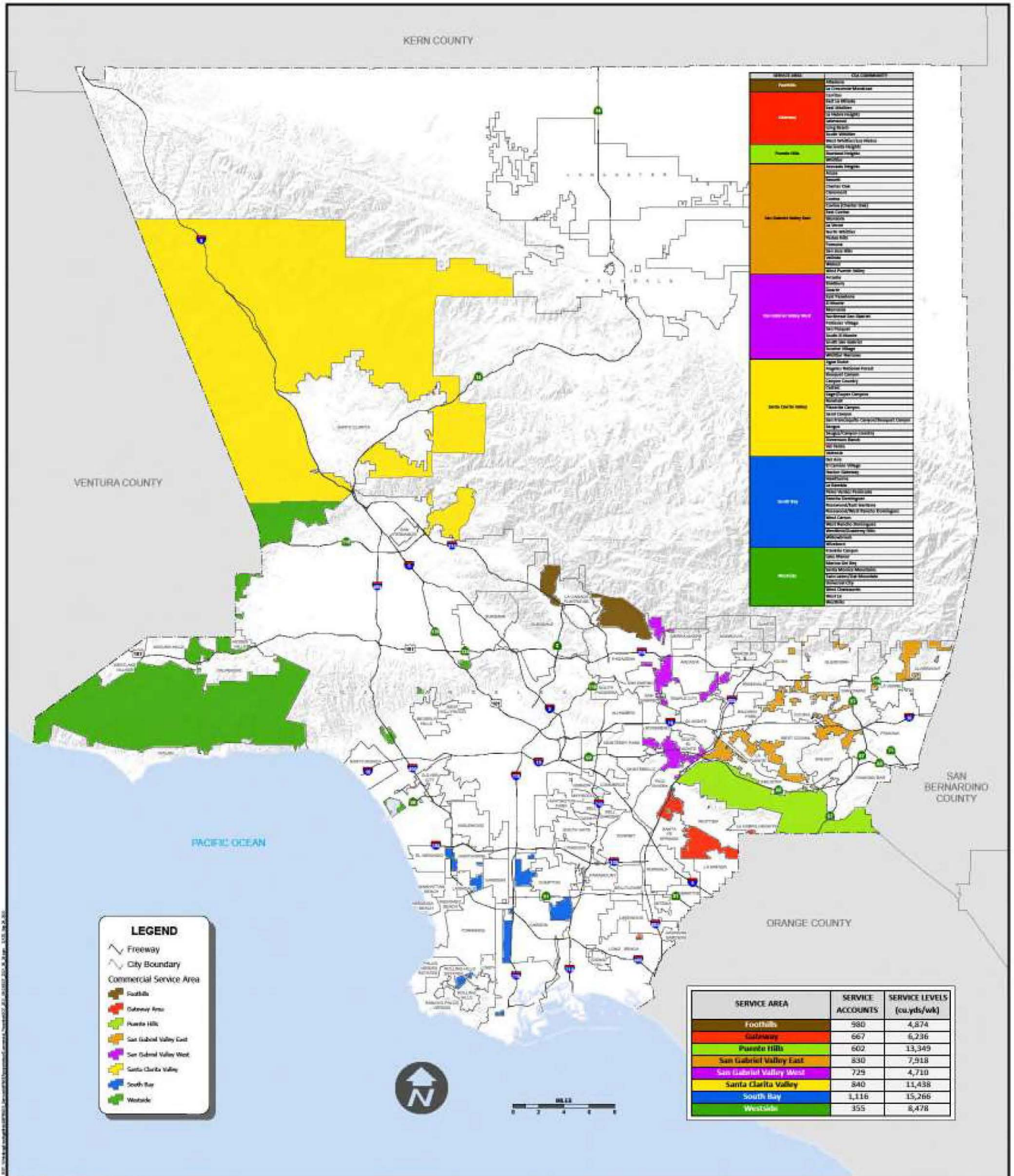

Service Areas Description:

The distribution of the zones balances the geography – in a rather contained capacity, as evident by the color grouping – with the total service accounts and service levels, emphasizing the latter.

The average size (and services) of the territories, which resulted in eight (8) zones, was based on Customer data, as determined to be appropriate capacity for waste haulers, though this is done with a greater emphasis on larger waste volumes to enable investment in Processing infrastructure.

This resulted in a natural variation among the Service Areas by size and services, which allows for different waste haulers to apply for a Service Area(s) based on their own operational capacities. Some Service Areas are intended to remain smaller to ensure viability for small waste haulers.

Foothills and San Gabriel Valley West Service Areas are the two (2) designated smaller Service Areas that have substantially lower total weekly service levels than the other six (6) Service Areas.

16.B.1- Exclusive Commercial Franchise Service Areas Data

The data provided by the existing Non-Exclusive Commercial Franchise (NECF) solid waste haulers was extracted to fit within each Service Area.

This data enabled COUNTY to compile a recent history of the Solid Waste Tonnage, and number of accounts and service levels from 2019 in the Communities that compose the new Exclusive Service Areas:

Historical Solid Waste (Tonnage)

Service Area	2020	2019	2018
Foothills	7,309	8,986	9,253
Gateway	15,180	12,907	12,712
Puente Hills	34,952	36,863	35,877
San Gabriel Valley East	21,129	20,703	17,835
San Gabriel Valley West	17,557	21,236	19,511
Santa Clarita Valley	26,686	31,900	27,933
South Bay	51,687	42,293	40,339
Westside	27,273	27,475	29,926

Estimated 2019 Account Distribution

Service Area	Number of Accounts	Commercial	Multifamily	Residential
Foothills	1,075	40%	37%	23%
Gateway	592	57%	35%	8%
Puente Hills	698	76%	19%	5%
San Gabriel Valley East	949	69%	7%	24%
San Gabriel Valley West	758	49%	32%	19%
Santa Clarita Valley	971	59%	5%	36%
South Bay	956	86%	12%	2%
Westside	452	84%	4%	12%

Estimated 2019 Service Level Distribution

Service Area	Organic Waste	Refuse Only	Refuse & Recycling	Recycling Only
Foothills	0%	96%	4%	0%
Gateway	0%	74%	26%	0%
Puente Hills	1%	74%	25%	0%
San Gabriel Valley East	1%	74%	25%	0%
San Gabriel Valley West	1%	76%	23%	0%
Santa Clarita Valley	0%	73%	25%	2%
South Bay	0%	84%	15%	1%
Westside	1%	73%	26%	0%

Projected 2022 Service Levels

COUNTY contracted for an independent analysis of all 2019 accounts located in the eight (8) identified Service Areas to project new service levels for all accounts to have a Three-Container system of Refuse, Recycling and Organic waste. The accounts were further organized into three (3) sectors: Commercial, Multifamily and Residential. The projected service levels for each Service Area per account type and per waste stream are indicated in Forms PW-2 and PW-3 Schedule of Prices.

The following assumptions were made for the Three-Container service level projection analysis:

- 1) There were 413 accounts, of which approximately 6% were identified as questionable (i.e., for Commercial, Multifamily and Residential sectors), not included in the analysis;
- 2) Dumpsters that are greater than or equal to eight (8) cubic yards (CY) were grouped into a Container size category of “8 CY to 40 CY”;
 - a. For the purpose of estimating the volume of material for this category, an average Dumpster size of 35 CY was used;
- 3) It was also noted that some of the accounts were listed to have zero (0) Collection frequency. The accounts with zero (0) frequency were included in the analysis as 1 time per week frequency;
- 4) Green Waste is managed by third party landscapers unless a Customer has existing Green Waste service;
- 5) The average Organic Waste percentage of total Refuse (CalRecycle, 2019) for each account type was estimated as follows:

- a. Commercial – 20% (except as noted below)
 - i. This is based on the average Organic Waste composition of 20+ industries;
 - ii. For accounts that are part of the Accommodation sector, the Organic Waste composition used was 32%;
 - iii. For accounts that are part of the Restaurant sector, the Organic Waste composition used was 51%;
 - iv. For accounts that are part of the Grocer sector, the Organic Waste composition used was 42%; and,
 - v. For accounts that are part of the Arts and Entertainment (includes amusement parks and event venues) sector, the Organic Waste composition used was 34%.
 - b. Multifamily – 25%
 - c. Residential – 18%
- 6) Less than 1% of the accounts had existing Organic Waste Collection in the 2019 dataset. The projected Organic Waste volume was estimated based on the size of the Refuse Containers, estimated Refuse density for the respective sector and the Organic Waste composition assumption above for all accounts.
- 7) The average recycling percentage of total Refuse (CalRecycle, 2019) for each sector is estimated as follows:
- a. Commercial – 46%
 - i. This is based on the average Recycling composition of 20+ industries.
 - b. Multifamily – 42%
 - c. Residential – 22%
- 8) Approximately 25% of accounts had existing Recycling Collection Services. The remaining projected Recycling volume was estimated based on the volume of the Refuse Containers for the accounts that do not have Recycling Collection;
- 9) For the purposes of the new projected service levels, the Organic Waste and Recycling volume is conservatively based on 100% capture rate;
- 10) The average Refuse percentage for each sector is estimated as followed:
- a. Commercial – 58%
 - i. Assumed a 100% capture of Organic Waste and 50% capture of Recycling; and,

- ii. For accounts that have high Organic Waste composition, it is assumed to have 75% capture of Organic Waste and 50% capture of Recycling.
 - 1. For accounts that are part of the Accommodation sector, the Refuse composition used was 55%;
 - 2. For accounts that are part of the Restaurant sector, the Refuse composition used was 40%;
 - 3. For accounts that are part of the Grocer sector, the Refuse composition used was 47%; and,
 - 4. For accounts that are part of the Arts and Entertainment (includes amusement parks and event venues) sector, the Refuse composition used was 55%.
- b. Multifamily – 54%
 - i. Assumed a 100% capture of Organic Waste and 50% capture of Recycling.
- c. Residential – 80%
 - i. Assumed a 50% capture of Organic Waste and 50% capture of Recycling.

The following assumptions were made for the Two-Container service level projections analysis, applicable to all Customer types:

1) Two-Container A (Gray and Blue Containers)

- i. Gray Container (Refuse and Organic Waste) - Utilized existing Non-Exclusive Commercial Franchise Customer Refuse service level data.
- ii. Blue Container (Recyclables)- Utilized Recycling projected service levels from the three-container service level projections analysis.

2) Two-Container B (Gray and Green Containers)

- i. Gray Container (Refuse and Recyclables) - Utilized existing Non-Exclusive Commercial Franchise Customer Refuse service level data.
- ii. Green Container (Organic Waste) - Utilized Organic Waste projected service levels from the three-container service level projections analysis.

The following assumptions were made for the One-Container service level projections analysis, applicable to all Customer types:

- 1) One-Container (Gray Container)
 - i. Utilized existing Non-Exclusive Commercial Franchise Customer Refuse service level data.

16.C.1- Public Education and Outreach Guidelines

This CONTRACT includes several outreach and education materials to be created by the CONTRACTOR and/or the COUNTY and disseminated in a timely manner to support waste Diversion goals and compliance with several mandates. Below is a check list summarizing most but not all of the CONTRACTOR'S obligation of education and outreach material.

A. Outreach material to be created by the COUNTY, with input from the CONTRACTOR, and disseminated by the CONTRACTOR:

1. Terms and Conditions
 - a. Subscription Order Form
 - b. Bill of Rights
2. Letter from the Director (to be included in Welcome Packet)
3. Monthly outreach (or less frequent, at County's discretion)
4. Community meeting presentations

B. Outreach material to be created by CONTRACTOR, approved by the COUNTY, and disseminated by the CONTRACTOR:

1. Site Visit and Waste Assessment
 - a. CONTRACTOR shall make recommendations when applicable for rightsizing and reducing Container sizes. CONTRACTOR may create in a form of survey, letter, or checklist (whichever seems appropriate) and may include:
 - i. Pictures of all Containers' contents
 - ii. Establishment information and characteristics
 - iii. Written recommendations for optimal service level
 - iv. Applicable and appropriate outreach material
 - v. On-site training for Commercial Customer's employees/staff that handle any Solid Waste and determine if any on-going training is necessary
 - vi. Determine placement of signage
 - vii. Determine needs for access
 - viii. Document the need for special services, such as a seasonal automated on-call compactor
2. Welcome Packet which may include:
 - a. Letter from the Director (Bilingual)
 - b. Letter from Contractor (Bilingual)
 - i. CONTRACTOR introduction
 - ii. Transition plan
 - iii. Community meeting dates
 - iv. Any other pertinent information

- c. Subscription order form, including rate schedules and fees for extra services
 - d. Los Angeles County Exclusive Commercial Franchise System and Service Area information
 - e. Billing information and customer service center location
 - f. Customer Bill of Rights and Responsibilities
 - g. Newsletter
 - h. Service Brochure
 - i. State waste Diversion goals and mandates
 - j. Education material for training purposes on how-to properly Recycle Organic Waste and Recyclables
 - k. Food DROP Program information
3. Annual outreach (bilingual)
- a. Provide customers education and outreach material to maximize Diversion of Recyclables, Organic Waste (both Food and Green Waste), Bulky Items, Sharps, and E-waste
4. Biannual newsletter
5. Non-Collection Notices
6. Container Labels
7. Notices for corrections or issues if necessary
8. Social Media signage, posts; and
9. Any other material CONTRACTOR wants to provide.

EXHIBIT 17 – Contractor Documentation

All documentation listed below is to be attached to CONTRACT as Exhibit 17. Use of Director provided templates is required where applicable.

A. Notice to Director Required

1. CONTRACTOR's Permit and Permit Application

Include all Permits required by County Code (such as a waste collector Permit from County Department of Public Health) or other Applicable Law. Including Green Waste Quarantine Zone Agreement with CDFA.

2. Container Specifications

Include Container capacity options, color, manufacturer's orders and invoices, label content and placement (item C of Exhibit 3A1).

3. Vehicle Specifications

Include vehicle identification number, model, make, year, purchase order (if applicable) and fuel type.

4. Subcontractors

Include Subcontractors' names, the amount of Goods or Services less than \$50,000 that each Subcontractor provides to CONTRACTOR, and a description of CONTRACTOR's relationships to each Subcontractor, including ownership interests; but excluding Director-approved Subcontractors (Part 5K of Exhibit 5).

5. Office Address

See Section 6A and Section 6B1, Contractor Office Hours.

B. Director Approval Required

1. Form of Non-Collection Notice (Item A5 of Exhibit 3A1)

2. Waiver of Liability

Include form of any waiver of liability (Section 4B1) and form of any Indemnification (Part 2 of Exhibit 5)

3. Terms and Conditions Summary (Item I1 of Exhibit 3A1)

a. Subscription Order Form

b. Bill of Rights

4. Unpermitted Waste Screening Protocol (Section 13)

5. Acknowledgment

Receipt of fact sheets relating to form of Nonemployee Injury Report (Part 2B6 of Exhibit 5) and Safely Surrendered Baby Law (Part 8B2 of Exhibit 5).

6. Insurance and Performance Assurance (Part 4 of Exhibit 5 and Section 15)

7. Internal Revenue Service Notice 1015 (Part 8B1 of Exhibit 5)

8. CONTRACTOR's EEO Certification (Part 8D3 of Exhibit 5)

9. Sharps Collection (Item F1a of Exhibit 3A1)

10. Director-Approved Subcontractors

Include Subcontractors' names, the amount of Goods or Services more than \$50,000 that each Subcontractor provides to CONTRACTOR, and a description of CONTRACTOR's relationships to each Subcontractor, including ownership interests (Part 5K of Exhibit 5).

11. Backup Service Plan (Section 11C)

12. Key Personnel (Section 4J)

With contact information (name, address, Office and mobile phone numbers, e-mail address)

a. ALL CONTRACTOR MANAGERS (see definition of "Contractor Manager" in Attachment 5-9A)

b. AUTHORIZED REPRESENTATIVE OF CONTRACTOR (Part 5H of Exhibit 5)

c. SERVICES SAFETY OFFICIAL (Part 8E1 of Exhibit 5)

13. Route Maps

Route maps are to indicate all starting and ending points.

14. Collection Schedule (Item A4 of Exhibit 3A1)

CONTRACTOR to submit the final approved collection schedule for their designated Service Area.

15. Solid Waste Collection and Facilities

Designated by CONTRACTOR (item D of Exhibit 3A1), including the following information:

- Name, location, owner, and operator, with telephone contact;
- Types of materials accepted and rejected; and
- If applicable, methodology used by each Processing facility for allocating materials, including Disposed residue, to the Service Area, with sample Reports; and
- Reasons for changing the facility designation in the future; and
- Rate charged per ton of waste.
- Designated Solid Waste Facility Unavailable/Use of alternative Solid Waste Facility

CONTRACTOR is to put the rate that facilities will charge per ton for Disposal and Diversion at the start of the CONTRACT on Forms PW-2 and PW-3 and update the facility list and rates as they change.

CONTRACTOR may designate a new facility that has higher fees than the prior facility, but it may not pass increased costs to its Customers or the COUNTY by increasing the Service Rate. The Service Rate will not be adjusted to compensate CONTRACTOR if costs at the new facility are greater than those at the prior facility.

16. Additional CONTRACTOR Commitments

Those made in its proposal for procurement of this CONTRACT (item K of Exhibit 3A1).

17. Transition Roll-Out Plan (item H of Exhibit 3A1)

CONTRACTOR must provide a detailed transition plan for the following:

- Transition from the existing Non-Exclusive Commercial Franchise system to the Exclusive Commercial Franchise System
- Transition for the Exclusive Commercial Franchise System

18. Difficult to Service Occupants (Item L of Exhibit 3A1)

CONTRACTOR must explain to Director:

- What changes CONTRACTOR will make for alternative Collection, such as different Collection Vehicle or manual Collection.

19. Alternative Container Sizes (Item C14 of Exhibit 3A1)

CONTRACTOR to submit alternatives to Container sizes for Premises with space restrictions.

20. Movement of Green Waste

CONTRACTOR shall comply with all Applicable Laws regarding transportation of Green Waste, including the California Department of Food and Agriculture's (CDFA's) regulations that quarantine certain types of Green Waste and restrict its movement. See the following website for more information: (<https://www.cdfa.ca.gov/plant/pe/InteriorExclusion/quarantine.html>).

CONTRACTOR shall give Director a copy of either of the following:

- Application to CDFA for the agreement
- The completed CDFA agreement

21. Contamination Monitoring Plan

Include the approved Contamination Monitoring Plan (Item J1 of Exhibit 3A1)

22. Procurement of Recovered Organic Waste Products (Item J4 of Exhibit 3A1)

CONTRACTOR to submit their final approved procurement plan.

EXCLUSIVE COMMERCIAL FRANCHISE CONTRACT FOR THE AREA OF SAN GABRIEL VALLEY
 EAST
 EXHIBIT 17—CONTRACTOR DOCUMENTATION
 A. NOTICE TO DIRECTOR REQUIRED
 SIGNATURE PAGE 1 of 3

TITLE	TOTAL NO. OF PAGES	CONTRACTOR INITIALS	COUNTY INITIALS
A.1 Contractor's Permit and Permit Application	7	DWP	CS
A.2 Container Specifications	18	DWP	CS
A.3 Vehicle Specifications	3	DWP	CS
A.4 Subcontractors	2	DWP	CS
A.5 Office Address	2	DWP	CS



 DIRECTOR

9/28/2022

 DATE

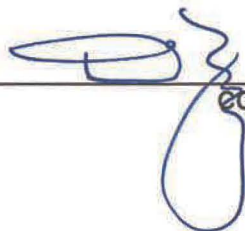

 CONTRACTOR

9/19/2022

 DATE

EXCLUSIVE COMMERCIAL FRANCHISE CONTRACT FOR THE AREA OF SAN GABRIEL VALLEY
EAST
EXHIBIT 17—CONTRACTOR DOCUMENTATION
B. DIRECTOR CONSENT REQUIRED
SIGNATURE PAGE 2 of 3

TITLE	TOTAL NO. OF PAGES	CONTRACTOR INITIALS	COUNTY INITIALS
B.1 Form on Non-Collection Notice	3	DMP	CS
B.2 Waiver of Liability	2	DMP	CS
B.3 Terms and Conditions Summary	12	DMP	CS
B.4 Unpermitted Waste Screening Protocol	4	DMP	CS
B.5 Acknowledgement	2	DMP	CS
B.6 Insurance and Performance Assurance	44	DMP	CS
B.7 Internal Revenue Service Notice 1015	2	DMP	CS
B.8 Contractor's EEO Certification (Form PW-8)	2	DMP	CS
B.9 Sharps Collection	2	DMP	CS
B.10 Director-Approved Subcontractors	2	DMP	CS
B.11 Backup Service Plan	3	DMP	CS
B.12 Key Personnel	2	DMP	CS
B.13 Route Maps	7	DMP	CS
B.14 Collection Schedule	2	DMP	CS
B.15 Solid Waste Collection and Facilities	16	DMP	CS
B.16 Additional Contractor Commitments	2	DMP	CS
B.17 Transition Roll-Out Plan	2	DMP	CS

EXCLUSIVE COMMERCIAL FRANCHISE CONTRACT FOR THE AREA OF SAN GABRIEL VALLEY
 EAST
 EXHIBIT 17—CONTRACTOR DOCUMENTATION
 C. DIRECTOR CONSENT REQUIRED
 SIGNATURE PAGE 3 of 3

B.18	Difficult to Service Occupants	2	DWP	CS
B.19	Alternative Container Sizes	2	DWP	CS
B.20	Movement of Green Waste	3	DWP	CS
B.21	Contamination Monitoring Plan	3	DWP	CS
B.22	Procurement of Recovered Organic Waste Products	2	DWP	CS



 DIRECTOR

9/28/2022

 DATE

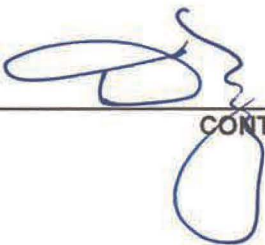

 CONTRACTOR

9/19/2022

 DATE

Exhibit 17 – Contractor Documentation

Item A.1 - CONTRACTOR's Permit and Permit Application

This item consists of 7 pages (including this page).

Section A.1: Contractor's Permit

Enclosed, please find the following Valley Vista Services permits, as required.

- Valley Vista Services, County of Los Angeles Waste Collector Permit from the Los Angeles County Department of Health Services. The current Waste Collector Permit is operational for calendar year **_2022___ (Number PR0157410);**
- Valley Vista Services, California Integrated Waste Management Board Covered E-Waste & Recycling permit for calendar year **_2022___ (CEWID # 105907);**
- Valley Vista Services, California Motor Carrier Permit for calendar year **_2022___ (CA 0366346);**
- Valley Vista Services, Department of Toxic Substances Control EPA Number as a hazardous waste generator/handler **(CAD053877940)**
- Valley Vista Services Annual Drop Box Permit for calendar year **2022 (PWRP2021010226)**
- Valley Vista Services, California Department of Food & Agriculture Compliance Agreement **No: 19-GW-0005**



THIS PERMIT MUST BE CONSPICUOUSLY DISPLAYED ON THE PREMISES

PUBLIC HEALTH PERMIT
Valid Until 12/31/2022

PR Number: PR0157410
Program ID: MUNICIPAL
Description: WASTE COLLECTOR YARD

Facility Owner - Mail Address
VALLEY VISTA SERVICES, INC.
17445 E RAILROAD ST
CITY OF INDUSTRY, CA 91748

Facility Location
VALLEY VISTA SERVICES, INC.
17445 E RAILROAD ST
CITY OF INDUSTRY, CA 91748

SW1



 DEPARTMENT OF MOTOR VEHICLES A Public Service Agency		MOTOR CARRIER PERMIT			
DEPARTMENT OF MOTOR VEHICLES Registration Operations Division P.O. BOX 932370 Sacramento, CA. 94232-3700 VALLEY VISTA SERVICES INC 17445 EAST RAILROAD ST CITY OF INDUSTRY, CA 91748		Valid From:	07/01/2021	Valid Through:	06/30/2022
		CA#:	0366346		
		The carrier named on this permit, having made written application to the Department of Motor Vehicles for a permit to operate as a motor carrier of property as defined in vehicle code section 34601, and having met the requirements and paid the appropriate fees, is granted a permit of the following classification:			
		 Private Full Year Corporation			
Pmt Date:	06/24/2021	Office #:	154		
Account #:	574487	Tech ID:	R1		
Sequence #:	0007	Amt Paid:	\$2,098.00		



Jared Blumenfeld
Secretary for
Environmental Protection

Department of Toxic Substances Control

Meredith Williams, Ph.D., Director
1001 "T" Street
P.O. Box 806
Sacramento, California 95812-0806



Gov'n Newsom
Governor

EPA ID PROFILE

Map ID Number: CAD00877940 State: ACTIVE
Name: VALLEY VISTA SERVICES INC. Inactive Date:
County: LOS ANGELES Record Entered: 7/23/1982 12:00:00 AM
NAICS: 48421 Last Updated: 7/15/2020 3:49:12 PM

	Name	Address	City	State	Zip Code	Phone
Location	VALLEY VISTA SERVICES INC.	1746 E RAILROAD ST	CITY OF INDUSTRY	CA	91746	
Mailing		1746 EAST RAILROAD ST	INDUSTRY	CA	91746000	
Owner	VALLEY VISTA SERVICES INC.	1746 EAST RAILROAD ST	INDUSTRY	CA	91746000	626411231
Operator/Contact	CITIZEN SERVICES PEACE MANAGER	1746 EAST RAILROAD ST	CITY OF INDUSTRY	CA	91746	626411231

Based Only Upon ID Number: CAD00877940

Call Methods?	Non-Call Methods?	Therapeutic Registration?
Yes	NA	NA

California and Non California Manifest Tonnage Total and Waste Code by Year Matrix by Entity Type (if available) are on the next page

Calif. Manifest Counts and Total Tonnage

Top line represents Manifest Count and Bottom line represents Total Tonnage

Year	Generator	Trans. 1	Trans. 2	TSDP	ALT. TSDP
1993	4 1,34210	0 0.0000	0 0.0000	0 0.0000	0 0.0000
1994	5 2,17350	0 0.0000	0 0.0000	0 0.0000	0 0.0000
1995	4 2,42360	0 0.0000	0 0.0000	0 0.0000	0 0.0000
1996	7 1,22090	0 0.0000	0 0.0000	0 0.0000	0 0.0000
1997	3 1,39170	0 0.0000	0 0.0000	0 0.0000	0 0.0000
1998	2 1,94480	0 0.0000	0 0.0000	0 0.0000	0 0.0000
2003	1 1,17930	0 0.0000	0 0.0000	0 0.0000	0 0.0000
2008	3 24,32600	0 0.0000	0 0.0000	0 0.0000	0 0.0000



**COUNTY OF LOS ANGELES
PUBLIC WORKS**

900 SOUTH FREMONT AVENUE
ALHAMBRA, CALIFORNIA 91803

PERMIT TYPE: Road
PERMIT CLASS/SUBCLASS: Encroachment

PERMIT#: PWRP2021010228
PERMIT STATUS: Issued
Page 1 of 14
ISSUE DATE: 01/31/2022
BY:
PERMIT OFFICE:

APPLICANT	ADDRESS	
VALLEY VISTA SERVICES, INC.	17445 E Railroad Street INDUSTRY, CA 91748	Business: (800)442-6454 email: N/A
Valley Vista Services Heather Bragdon	17445 Railroad Street City of Industry, CA 91748	Business: (626)855-5581 email: heatherb@myvvs.com
LOCATION: 17445 Railroad Street Rowland Heights, CA 91748 Various unincorporated areas in LA County		PROJECT/WORK ORDER NO.



COMPLIANCE AGREEMENT for the use with MASTER PERMIT QC 1289/1290/1291/1292/1337
(Pursuant to California Code of Regulations 3154 and Applicable CCRs Checked Below)

Provisions for the Intra-state Movement of GREEN WASTE
Originating within the State Interior Quarantine for (check all that apply):

- Asian Citrus Psyllid (CCR 3435)
- Huanglongbing (CCR 3439)
- European Grapevine Moth (CCR 3437)
- Light Brown Apple Moth (CCR 3434)
- Oak Mortality Disease Control/Phytophthora ramorum (CCR 3700)

Compliance Agreement No: 19-GW-0005

- PROGRAM**
The California Department of Food and Agriculture (CDFA), and the Los Angeles
County Agricultural Commissioner cooperating as the Program.

PROGRAM INFORMATION
Los Angeles County Agricultural Commissioner's Office

Street Address: 12300 Lower Azusa Road
 City: Arcadia Zip Code: 91006
 Program Officer: _____
 Phone (626) 575 - 5471 Fax (_____) _____
 Email _____

- BUSINESS/ESTABLISHMENT:**
Establishment Name (subsequently referred to as "Establishment"): VALLEY VISTA SERVICES INC.

ESTABLISHMENT INFORMATION
 Owner Name DAVID M. PEREZ - SECRETARY
 Manager Name DAVID M. PEREZ
 Phone (626) 961 - 6291 Fax (626) 581 - 7615
 Email DAVIDPEREZ@ZEREPMANAGEMENT.COM
 Mailing Address: 17445 E. RAILROAD STREET
 City CITY OF INDUSTRY Zip Code 91748
 (check box if physical address is the same as mailing address)
 Physical Address: _____
 City _____ Zip Code _____
 Thos Bros _____ X St _____
 GPS _____

BACKGROUND:

The pests known as Asian citrus psyllid, European grapevine moth, light brown apple moth and *Phytophthora ramorum* present a real and ongoing threat to the agricultural industry, environment and economy of the State of California. Movement of regulated articles and commodities is a recognized channel for the spread of these pests from established areas to new locations. The Program is a cooperative effort between public entities that are responsible for mitigating the movement of these pests from regulated areas where the pest is established to new locations.

AGREEMENT:

A. The Program, will permit your establishment to self-execute the quarantine requirements attached as exhibits checked below, inclusive and incorporated into this agreement by reference as if fully set out. The exhibits checked below are binding:

CHECK ALL EXHIBITS THAT APPLY:

- Exhibit GW2 **BIOMASS/COGENERATION (Processed and Unprocessed)**
- Exhibit GW4 **COMPOSTING (Processed and Unprocessed)**
- Exhibit GW5 **LANDFILL (Processed and Unprocessed)**
- Exhibit GW10 **HAULER/TRANSPORTER Moving Green Waste Resulting from the Processing of Regulated Articles (e.g. bulk grapes for crush) that Originated in a Quarantine Area**
- Exhibit GW12 **TRANSFER STATION**

B. In exchange for the Program's promise contained in sub-paragraph "A" above, the Establishment agrees to abide by the following rules and regulations:

1. Handle, process, and/or move regulated articles in accordance with the quarantine requirements for each pest checked on page 1;
2. Follow the Program's instructions regarding the use of all permits and certificates;
3. Maintain and make such records as the Program requires, accessible for inspection upon reasonable notice by the Program Officer. These records shall be maintained for a period of the later of 2 years or the resolution of any outstanding claims.

C. This agreement becomes effective on signing and shall remain in effect until canceled by either party on 30 days notice to the other at the address of either appearing above. However, the Program may accelerate the notice to immediate for cause, including but not limited to the Establishment's abandonment of the procedures outlined in the attached Exhibit(s).

D. Establishment assumes liability, if any, arising from the manner in which Establishment sells, handles or distributes any regulated host material.

NOTICE: Any signatory or employee of any signatory who violates the terms of this Compliance Agreement may be subject to Civil Penalties pursuant to California Food and Agricultural Code Section 5705.

Signed in the County of <u>LOS ANGELES</u> in the State of California on <u>5</u> / <u>20</u> / <u>2021</u>	
Establishment by: (print name) VALLEY VISTA SERVICES INC.	Program by: (print name) Dayna Napolillo
Manager/Owner (signature):  DAVID M. PEREZ - SECRETARY	Program Officer (signature): 

Exhibit 17 – Contractor Documentation

Item A.2 - Container Specifications

This item consists of 18 pages (including this page).

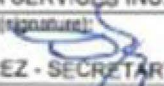
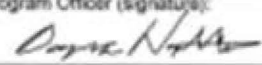

Pitch Top Front Load Container



Dimensions and Drawing

PRODUCT #	SIZE	FRONT HEIGHT		BACK HEIGHT		WIDTH	LENGTH
		A*	B*	C	D**		
9001	1.5 YD	28.5"	34.5"	28.5"	72"		
9002	2 YD	34.5"	41.5"	34.5"	72"		
9003	3 YD	41.5"	50.5"	41.5"	72"		
9007	4 YD	48"	57"	50.5"	72"		

* Casters add 8" to height
** End loader = 80"

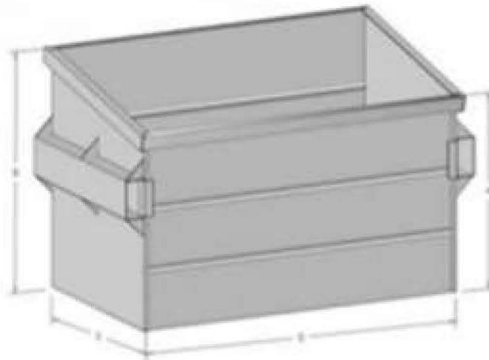

8613 Mulberry Avenue
Fontana, CA 92335
800.635.8335

confab.com



A California waste container company
 TOLL FREE (800) 835-8336
 Website: www.confab.com • E-mail: sales@confab.com

CONTAINER QUOTE

SoCal (818) 901-1006 • FAX (818) 787-8312
 NorCal (926) 745-4624 • FAX (926) 745-4218
 OFFICE VALLEJO
 OFFICE VALLIJO

VALLEY VISTA SERVICES 17445 E. RAILROAD ST. CITY OF INDUSTRY, CA 91748 GINA CERVAANTES 626-961-5537 Fax 626-961-1100	VALLEY VISTA SERVICES 17445 E. RAILROAD ST. CITY OF INDUSTRY, CA 91748 DAVE PEREZ 626-961-8231 Fax 626-961-1100
MET 30 DAYS AA Q08429	DATE ORDERED 03/01/22 DATE RECEIVED NAME SHIP TO SRK SALVATIERRA

ITEM NO.	QUANTITY	DESCRIPTION	UNIT PRICE	UNIT TOTAL
9002-1	100	2 YD PITCH TOP W/12 GA BOTTOM	897.00	89700.00
FRMT	4	FREIGHT - NON-TAXABLE	625.00	2500.00

LEGS	19212	- 2 YD F.L. IMPACT PLASTIC LIDS L34401R
CHANNELS	20225-5	- E.L. 17" BOT TO BOT (FLUSH FRONT & REAR)
CASTERS	28147-3	- 6" IMPACT POLE "O" CASTERS 4 EA SWIVEL W/OUT CASTERPLATES
DRAIN PLUG	NONE	- NONE
I.D.		N/A (TLF)
OPTION A	141W	- 14" INSTREAM WELD
OPTION B	27531	- STANDARD 10 GA WRAFAFORD CASTERPLATES
OPTION C	PACKET	- ANGLE BUMPERS FRONT AND REAR
OPTION D	21801-1	- STANDARD TACO GUSSET & STRAP ASSEMBLY (DOUBLE END)
OPTION E	18832-2	- LID ROD ASSY, STD 72" F.L. WELDED WASHER/WELDED KADDER W/TRODS
OPTION F	SCCL	- NO CAUTION/CAUTION LABEL
OPTION G		
OPTION H		
SERIAL #s	VVS 210208-210307	
COMMENTS	UNLESS SPECIFIED WITH BOXING - 1927 ETC	

CITY

TAX
 TAX
 TAX
 TAX
 TAX
 TAX

GRAND TOTAL	92200.00
INC. IN PRICE	
TAX	8521.50
TOTAL	100721.50
FWD	0.00
GRAND TOTAL	100721.50

The Wastepipe Terms & Conditions of Sale ("WG T&C") located at <https://www.confab.com/terms-conditions-of-sale> as of the date set forth in Section 1(j) of the WG T&C and are made a part of this Quote. These WG T&Cs may be updated from time to time and are available by hardcopy upon request.



A California waste container company

TELL FREE (800) 835-8330
Website: www.confab.com • E-mail: sales@confab.com

CONTAINER QUOTE

SanCal (818) 901-1005 • FAX (818) 787-8312
NoCal (209) 745-4604 • FAX (209) 745-4218
SUN 007
VAL114

VALLEY VISTA SERVICES 17445 E. RAILROAD ST. CITY OF INDUSTRY, CA 91748 GINA CERVANTES 626-855-5537 Fax 626-855-5557	VALLEY VISTA SERVICES 17445 E. RAILROAD ST CITY OF INDUSTRY, CA 91748 DAVE PEREZ 626-961-6291 Fax 626-961-1109
DATE: 03/01/22 TIME: 10:00 AM SALES PERSON: ERIK SALVATERRA	QUOTE # Q08430

ITEM NO.	QTY	DESCRIPTION	UNIT PRICE	EXT TOTAL
9007-1	100	4 YD PITCH TOP N/12 GA BOTTOM	1206.00	120600.00
FRONT	5	FREIGHT - NON-TAXABLE	625.00	3125.00

LIBS	19014	- 4 YD P.L. IMPACT PLASTIC LIDG E345YIP
CHANNELS	20027-5	- K.L. 28" BOT TO BOT FLOOR FRONT & REAR
CASTERS	28147-3	- 6" IMPACT POLY "O" CASTERS 4 EA SWIVEL W/OUT CASTERPLATES
DRUM RING	NONE	- NONE
LD		W/A (TLF)
OPTION A	161W	- 16" INSTEAM WELD
OPTION B	21601-1	- STANDARD TACO GUSSET & STRAP ASSEMBLY (DOUBLE END)
OPTION C	27551	- STANDARD 12" GA WRAPAROUND CASTERPLATES
OPTION D	10893-2	- LID ROD ASSY, STD 72" P.L. WELDED WASHER/WELDED WASHER W/PROPS
OPTION E	TACKET	- ANGLE BUMPERS ON FRONT AND REAR
OPTION F	UCCL	- NO CAUTION/CAUTION LABEL
OPTION G		
OPTION H		
SERIAL #s	VVS 410108-410207	
COMMENTS	UNST-PROCT-NLDR LOCKMAN-41018-BA	

IN
 FR
 FR-RT
 COLOR
 MESA TAX

GRAND TOTAL	123725.00
TAX	11457.00
TOTAL	135182.00
PAY	0.00
BAL. DUE	135182.00

9.500

The Wastegrip Terms & Conditions of Sale ("WG T&C") located at: <http://www.wastegrip.com/terms> apply to this quote as of the date set forth in Section 1(a) of the WG T&C and are made a part of this Quote. These WG T&Cs may be updated from time to time and are available by hardcopy upon request.



A California waste container company

TOLL FREE (800) 625-8335
 Website: www.confab.com • E-mail: sales@confab.com

CONTAINER QUOTE

SanCal (916) 901-1605 • FAX (916) 787-6312
 SanCal (209) 745-4604 • FAX (209) 745-4219
 OFF VAL1114

VALLEY VISTA SERVICES 17443 E. RAILROAD ST. CITY OF INDUSTRY, CA 91748 GINA CERVANTES 626-855-5537 Fax 626-855-5557	VALLEY VISTA SERVICES 17443 E. RAILROAD ST. CITY OF INDUSTRY, CA 91748 DAVE PEREZ 626-961-6191 Fax 626-961-5105
NET 30 DAYS	DATE 03/01/22 SALES PERSON ERIK SALVATIERRA

ITEM NO.	QUANTITY	DESCRIPTION	UNIT PRICE	UNIT TOTAL
9005-2	300	3 YD PITCH TOP W/12 GA BOTTOM	1025.00	307500.00
PAINT	10	HEIGHT - NON-TAKABLE	625.00	6250.00

LID	19013	- 3 YD F.L. IMPACT PLASTIC LIDS	
		136471P	
CHANNEL	20028-0	- EL 34" BOT TO BOT (FLASH FRONT & REAR)	
CASTERS	28147-3	- 4" IMPACT POLY "O" CASTERS	
		4 EA SWIVEL W/OUT CASTERPLATES	
DRAIN PLUG	NONE	- NONE	
L.D.		W/A (ILP)	
OPTION A	141W	- 1/4" INREAM WELD	
OPTION B	21601-1	- STANDARD TACO GUSSET & STRAP ASSEMBLY (DOUBLE END)	
OPTION C	27551	- STANDARD 12" GA WELDPAINTING CASTERPLATES	
OPTION D	PACKET	- XBUCK BURNERS FRONT & REAR	
OPTION E			
OPTION F	18893-2	- LID 800 ASST, STD 12" F.L. WELDED WASHER/WELDED WASHER W/PROPS	
OPTION G	SCCL	- NO CRUTTON/CAPTION LABEL	
OPTION H			

CITY1

LN	XX
PR IN	
PR OUT	
COLOR	MESA TAN

SERIAL #

VVS 39807-310107

COMMENTS

~~UNIT PRICE WITH LOCKRAMP - 51057 EA~~

BLA TOTAL	313750.00
BLA IN PRICE	
TAX	29212.50
TOTAL	342962.50
PAID	0.00
BLA	342962.50

9.500

The Wastegate Terms & Conditions of Sale ("WG T&C") located at: <https://www.wastegate.com/assets/conditions-of-sale> as of the date set forth in Section 1(b) of the WG T&C and are made a part of this Quote. These WG T&Cs may be updated from time to time and are available by hardcopy upon request.



A California waste container company

TEL: (951) 800-8338
 Website: www.confab.com • E-mail: sales@confab.com

CONTAINER QUOTE

SoCal (918) 901-1005 • FAX (918) 787-8312
 NewCal (209) 745-4934 • FAX (209) 745-4219

OFFICE VAL114
 CREDIT VAL114

VALLEY VISTA SERVICES 17445 E. RAILROAD ST. CITY OF INDUSTRY, CA 91748 GINA CERVANTES 626-853-3337 Fax 626-853-5557	VALLEY VISTA SERVICES 17445 E. RAILROAD ST. CITY OF INDUSTRY, CA 91748 DAVE PEREZ 626-961-6291 Fax 626-961-1109
ORDER NO. [] DATE ORDERED 04/18/22 QUOTE RECEIVED 04/18/22	SALES PERSON ERIC SALVATIERRA
NET 30 DAYS PAY TO AA PO# 009284	SALES PERSON ERIC SALVATIERRA

ITEM NO.	QUANTITY	DESCRIPTION	UNIT PRICE	NET TOTAL
3007-1	100	4 YD PITCH TOP W/12 GA BOTTOM	1204.00	120400.00
FRHT	5	FREIGHT - NON-TAXABLE	625.00	3125.00

LOGS	19014	- 4 YD P.L. IMPACT PLASTIC LOGS L36372P
CHANNELS	20027-5	- E.L. 28" BOT TO BOT FLUSH FRONT & REAR
CASTERS	20147-3	- 4" IMPACT POLY "O" CASTERS 4 EA SWIVEL W/OUT CASTERPLATES
DRUM PLEG	NONE	- NONE
I.D.		*VVS 410108 TRU VVS 410207* (TLF)
OPTION A	141M	- 1/4" INDCAN WELD
OPTION B	21601-1	- STANDARD TACO GUSSET & STRAP ASSEMBLY (DOUBLE END)
OPTION C	21551	- STANDARD 10 GA WRAFAROUND CASTERPLATES
OPTION D	18893-2	- LOG HOD ASST. STD 72" P.L. WELDED WASHER/WELDED WASHER W/PROPS
OPTION E	PACKET	- ANGLE BUSHERS ON FRONT AND REAR
OPTION F	SOCL	- NO CAUTION/CAUTION LABEL
OPTION G		
OPTION H		
SERIAL #s	VVS410308 - 4108407	
COMMENTS		

CITY

IN
 EX
 FR
 FR OUT
 ORDER: MELSA TAN

SUB TOTAL	123725.00
DISC. IN PRICE	
TAX	1167.00 9.500
TOTAL	125182.00
PAY	0.00
BAL. DUE	125182.00

The Warrantee Terms & Conditions of Sale ("WGTAC") located at: http://www.confab.com/links/conditions_of_sale or of the date set forth in Section 130 of the WGTAC and are made a part of this Quote. These WGTACs may be updated from time to time and are available by hardcopy upon request.



A California waste container company

TOLL FREE (800) 636-8336
Website: www.confab.com • E-mail: sales@confab.com

CONTAINER QUOTE

SoCal (918) 901-1036 • FAX (918) 767-8312
MarCal (209) 745-4604 • FAX (209) 745-4219

0
007
VALL14

VALLEY VISTA SERVICES 17445 E. RAILROAD ST. CITY OF INDUSTRY, CA 91748 GINA CERVANTES 626-955-5537 Fax 626-955-5057	VALLEY VISTA SERVICES 17445 E. RAILROAD ST CITY OF INDUSTRY, CA 91748 DAVE PEREZ 626-951-6291 Fax 626-951-1109
NET 30 DAYS	DATE ORDERED 04/18/22 DATE RECEIVED 04/18/22
ORDER NO. QD9286	ORDER PERSON ERIC SALVATIERRA

ITEM NO.	QUANTITY	DESCRIPTION	UNIT PRICE	UNIT TOTAL
9005-2	300	3 YD PITCH TOP W/12 GA BOTTOM	1025.00	307500.00
FRMT	10	FREIGHT - NON-TAXABLE	625.00	6250.00

LOCS	19013	- 3 YD P.L. IMPACT PLASTIC LIDS
CHANNELS	20026-8	- EL 24" BOT TO BOT (FLUSH FRONT & REAR)
CASTERS	28143-3	- 6" IMPACT POLY "O" CASTERS
DRUM PLUG	DONS	- NONE
I.D.		*VVS3 9807 THRU VVS3 10106* (TLF)
OPTION A	161W	- 16" INDEAN WELD
OPTION B	21801-1	- STANDARD TACO GUSSET & STRAP ASSEMBLY (DOUBLE END)
OPTION C	27551	- STANDARD 18 GA BRASS/ALUMINUM CASTERPLATES
OPTION D	PACKET	- ANGLE SURFERS FRONT & REAR
OPTION E		
OPTION F	18893-2	- LID RCG ASSY, STD 72" F.L. WELDED WASHER/WELDED WADEN W/PROPS
OPTION G	SOCL	- NO CAUTION/CAUTION LABEL
OPTION H		
SERIAL #V	VVS310508 - 310807	
COMMENTS		

CITY	
XX	
MS	
MS 007	
COLOR	MESA TAN
MS TOTAL	313750.00
MSL	IN PRICE
TAX	29212.50 9.500
TOTAL	342962.50
PAID	0.00
MSL	342962.50

The Wastepipe Terms & Conditions of Sale ("WGTAC") located at: <https://www.confab.com/wgtac> are hereby accepted as part of the data set forth in Section 1(b) of the WGTAC and are made a part of this Quote. These WGTACs may be updated from time to time and are available by hyperlink upon request.



A California waste container company

TOLL FREE (800) 838-8339
Website: www.confab.com • E-mail: sales@confab.com

SoCal (916) 801-1600 • FAX (916) 787-8312
NorCal (925) 748-8804 • FAX (925) 748-8318

CONTAINER QUOTE

3
007
VALL14

VALLEY VISTA SERVICES 17445 E. RAILROAD ST. CITY OF INDUSTRY, CA 91748 GINA CERVANTES 626-855-5537 Fax 626-855-3357	VALLEY VISTA SERVICES 17445 E. RAILROAD ST CITY OF INDUSTRY, CA 91748 DAVE PEREZ 626-961-6291 Fax 626-961-1108
NET 30 DAYS	DATE ORDERED 05/11/22 DATE DELIVERY 05/11/22
AA WAF Q09639	NAME PERSON ERIK SALVATIERRA

ITEM NO	QUANTITY	DESCRIPTION	UNIT PRICE	UNIT TOTAL
9057-1	200	4 YD PITCH TOP W/12 GA BOTTOM	1162.00	232400.00
FRONT	10	FREIGHT - NON-TAXABLE	750.00	7500.00

LEN	19014	- 4 YD F.L. IMPACT PLASTIC LIDS
		L3657IP
CHANNELS	20027-5	- E.L. 28" BOT TO BOT FLASH FRONT & REAR
CASTERS	20147-3	- 4" IMPACT POLY "O" CASTERS
		4 EA SWIVEL W/OUT CASTERPLATES
DRUM PADS	NONE	- NONE
LD		W/A (TLP)
OPTION A	141W	- 14" INSEAM WELD
OPTION B	21601-1	- STANDARD TACO CUSSET & STRAP ASSEMBLY (DOUBLE END)
OPTION C	27551	- STANDARD 12 GA REARROUND CASTERPLATES
OPTION D	18893-2	- STD ROD ASSY, STD 12" F.L. WELDED WASHER/WELDED WASHER W/FRONS
OPTION E	PACRY	- ANGLE HORNERS ON FRONT AND REAR
OPTION F	ECCL	- NO CAUTION/CAUTION LABEL
OPTION G		
OPTION H		
SERIAL #s	WS411608-411807	
COMMENTS		

MR	XX
MR	
MR	

NAME: MESA TAN

GR TOTAL	239900.00	
INC.	IN PRICE	
TAX	22078.00	9.50%
TOTAL	261978.00	
P&D	0.00	
GR	261978.00	

The Wasteway Terms & Conditions of Sale ("WG T&C") located at: <https://www.wasteway.com/terms-conditions-of-sale> as of the date set forth in Section 1(b) of the WG T&C and are made a part of this Quote. These WG T&Cs may be updated from time to time and are available by hardcopy upon request.



A California waste container company

Toll Free (800) 435-8328
 Website: www.confab.com • E-mail: sales@confab.com

SoCal (916) 961-1005 • FAX (916) 787-6312
 NewCal (209) 748-4804 • FAX (209) 748-4218

CONF # 007
 CUSTOMER VAL1114

CONTAINER QUOTE

VALLEY VISTA SERVICES 17443 E. RAILROAD ST. CITY OF INDUSTRY, CA 91748 GINA CERVANTES 626-961-8551 Fax 626-961-5557	VALLEY VISTA SERVICES 17443 E. RAILROAD ST. CITY OF INDUSTRY, CA 91748 DAVE PEREZ 626-961-6291 Fax 626-961-1100
DATE ORDERED 05/11/22 DATE RECEIVED 05/11/22	SALES MANAGER ERIC SALVATIERRA
KEY 30 DAYS NEW # AA *** Q09437	SALES OFFICE

ITEM #	QUANTITY	DESCRIPTION	UNIT PRICE	NET TOTAL
9005-2	600	3 YD PITCH TOP W/12 GA BOTTOM	987.00	592200.00
FRWT	20	FREIGHT - NON-TAXABLE	750.00	15000.00

USE	19013	- 3 YD F.L. IMPACT PLASTIC LIDS L36471P
CHANNELS	20026-8	- EL. 24" BOT TO BOT (FLUSH FRONT & REAR)
CASTERS	28147-3	- 4" IMPACT POLY #0" CASTERS 4 EA SWIVEL W/OUT CASTERPLATES
DRUM PLUG	NONE	- NONE
L.D.		W/A (TLF)
OPTION A	161W	- 16" INSEAM WELD
OPTION B	21431-1	- STANDARD TACO GUSSET & STRAP ASSEMBLY (DOUBLE END)
OPTION C	27551	- STANDARD 10" GA WHAFEROUND CASTERPLATES
OPTION D	PACKET	- ANGLE BUNDLES FRONT & REAR
OPTION E		
OPTION F	18893-2	- LTD ROD ASSY, STD 72" F.S. WELDED WASHER/WELDED WASHER W/PROPS
OPTION G	00CL	- NO CAUTION/CAUTION LABEL
OPTION H		
SERIAL #:	VVS311008-311607	
COMMENTS		

CITY:

XX

 COLOR: MELBA TAN

GRN TOTAL	607200.00
ENC. IN PRICE	
TAX	56239.00 9.500
TOTAL	663439.00
PAID	0.00
BAL. DUE	663439.00

The Waste-to-Terra Terms & Conditions of Sale ("WTO T&C") located at: <https://www.wasteto-terra.com/doc/conditions> apply to all of the data set forth in Section 1(b) of the WTO T&C and are made a part of this Quote. These WTO T&Cs may be updated from time to time and are available by hardcopy upon request.



A California waste container company

TOLL FREE (800) 833-8338
Website: www.confab.com • E-mail: sales@confab.com

SanCal (916) 901-1000 • FAX (916) 767-6313
SanCal (209) 740-4604 • FAX (209) 740-4219

SanCal (916) 901-1000
SanCal (209) 740-4604
SanCal (209) 740-4219
VALL14

CONTAINER QUOTE

VALLEY VISTA SERVICES 17445 E. RAILROAD ST. CITY OF INDUSTRY, CA 91748 GINA CERVANTES 626-833-5337 Fax 626-855-5557	VALLEY VISTA SERVICES 17445 E. RAILROAD ST. CITY OF INDUSTRY, CA 91748 DAVE PEREZ 626-941-6291 Fax 626-941-1109
MET 30 DAYS Q09635	DATE QUOTED 05/11/22 DATE REQUIRED 05/11/22 SALES PERSON ERIK SALVATIENNA

ITEM NO.	QUANTITY	DESCRIPTION	UNIT PRICE	TOTAL
9002-1	200	2 YD PITCH TOP W/12 GA BOTTOM	865.00	173000.00
FRINT	8	FREIGHT - NON-TAXABLE	750.00	6000.00

LEAD	19212	- 2 YD P.L. IMPACT PLASTIC LIDS 13660IB
CHANNELS	20025-5	- E.L. 17" BOT TO DOT (FLOSH FRONT & REAR)
CASTERS	28147-3	- 4" IMPACT POLY "O" CASTERS 4 EA SWIVEL W/OUT CASTERPLATES
DRAIN PLUG	NONE	- NONE
LB.		N/A (ILP)
OPTION A	161W	- 16" INSURAN WELD
OPTION B	27551	- STANDARD 10" GA WELDFORMER CASTERPLATES
OPTION C	PACKET	- ANGLE SCISSORS FRONT AND REAR
OPTION D	21601-1	- STANDARD TACO GUSSET & STRAP ASSEMBLY (DOUBLE END)
OPTION E	18883-2	- LID W/O ASBY, STD 72" F.L. WELDED WASHER/WELDED WASHER W/PROPS
OPTION F	DOCL	- NO CAUTION/CAUTION LABEL
OPTION G		
OPTION H		
SERIAL #s	VVS 2-10808-211007	
COMMENTS		

CR	XX
FR	
FR OUT	

COLOR MEDIA TAN

GRS TOTAL	179000.00
GRS IN PRICE	
TAX	16435.00
TOTAL	195435.00
PAYD	0.00
GRS BAL	195435.00

The Wastemap Terms & Conditions of Sale ("WG T&C") located at: <https://www.wastemap.com/termsandconditions.pdf> as of the date set forth in Section 1(b) of the WG T&C and are made a part of this Quote. These WG T&Cs may be updated from time to time and are available by hyperlink upon request.



Location:
 1900 Ross Road, Livermore, CA 94550
 620 West Woodbridge Lane, Dallas, TX 75087
 1100 W. 20th St, Los Angeles, CA 90002
 1401 Woodbridge Dr, Woodbridge, VA 22192

8675 Commerce St, Dallas, TX 75248
 7800 130th St, Houston, TX 77066
 4910 East 29th St, Los Angeles, CA 90002

Proposal

Proposal #: 210758 Date: 12/21/2021

December 28, 2021

Buyer	Seller
Valley Vista Services 17448 E Railroad Street City of Industry, Ca 91746	Valley Vista Services 17448 E Railroad Street City of Industry, Ca 91746
Billing Contact	Shipping Contact
Name: David Perez Phone: (925) 853-6652 E-mail: DavidPerez@corpmanagement.com	None

ITEM DESCRIPTION	QUANTITY	UNIT PRICE	EXTENDED PRICE
Commercial Container Type: 4 yard Front Load Container Body Color Requested: Karmoon Blue Lid Color Requested: Black Wheels / Casters: SPD - 4 Dual Polyurethane Castor Options: Gravity Lock Bar Kit Artwork: Artwork Facilitated Fee 	35	\$1,165.00	\$ 40,775.00
Commercial Container Type: 3 yard Front Load Container Body Color Requested: Karmoon Blue Lid Color Requested: Black Wheels / Casters: SPD - 4 Dual Polyurethane Castor Options: Gravity Lock Bar Kit Artwork: Artwork Facilitated Fee 	300	\$970.00	\$ 291,000.00
Commercial Container Type: 2 yard Front Load Container Body Color Requested: Karmoon Blue Lid Color Requested: Black Wheels / Casters: SPD - 4 Dual Polyurethane Castor Options: Gravity Lock Bar Kit Artwork: Artwork Facilitated Fee 	35	\$620.00	\$ 21,700.00

Is Product Taxable?	Yes	Subtotal =	\$ 417,700.00
Is Freight taxable?	No	Tax on Product =	\$ 21,288.28
Tax Rate:	7.50%	Truckload Freight Rate =	\$ 12,200.00
Terms:	Net 30 Days	Tax on Freight =	
		Total =	\$ 451,188.28

ADDITIONAL: 85104847676

Contract Options:	None
Ship From:	RM, Free Facility
Leadtime:	Six Months After PO Received in Store
Warranty:	3 year unprorated warranty
Quote Valid:	30 Days
Terms:	All applicable taxes shall be paid by the Buyer unless a proper exemption is provided and verified.

*** All Credit Card transactions are subject to a 3% processing fee.

PREPARED BY: Steven Richard Steven Richard Environmental Sales Representative Direct: (925) 413-8873 srichard@valleyvista.com	ACCEPTED BY:  DAVID PEREZ 12/28/21 Signature Print Name Title: PASSION-FAST
---	--

To indicate order, please call or send signed proposal via email to Purchase@corpmanagement.com

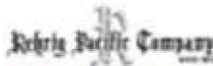

Locations:
 1685 West Coast Levee, San Jose, CA 95128
 420 West Montgomery Lane, Tulsa, TX 74107
 1740 W. 20th St, Fort, TX 76022
 7402 Peachtree Dr., Atlanta, GA 30338
 8975 Commerce Dr., Dallas, TX 75241
 7800 W. 16th St., Phoenix, AZ 85048
 40101 W. 10th St., Los Angeles, CA 90044

Proposal

Proposal #: CC 211208R2 December 26, 2021

Order #: 210759	Ship #: 214779
Valley Vista Services 17445 Railroad St City of Industry, CA 91748	Valley Vista Services 17445 Railroad St City of Industry, CA 91748
Billing Contact:	Shipping Contact:
Name:	Name:
Phone:	Phone:
E-mail:	E-mail:

ITEM DESCRIPTION	QUANTITY	UNIT PRICE	EXTENDED PRICE
Commercial Container Type: 2 yard Front Load Container Body Color: Forest Green Lid Color: Black Wheels / Casters: SFO - 4 Swivel Polyureth Castor Options: Artwork and Serial Number Fee	42	\$825.00	\$ 34,650.00
Artwork:	42	\$96.00	\$ 4,032.00
Is Product Taxable? Yes Is Freight Taxable? Yes Tax Rate: 7.625% Terms: Net 30 Days		Subtotal = Tax on Product = Freight Rate = Tax on Freight = Total =	\$ 41,832.00 \$ 3,162.27 \$ 1,206.00 \$ 91.23 \$ 46,291.47

ADDITIONAL INFORMATION

Contract Options: None
 Ship From: Fresno, CA
 Lead Time: 11 weeks or sooner
 Warranty: 3 year unprorated warranty
 Quote Valid: 30 Days
 Taxes: All applicable taxes shall be paid by the Buyer unless a proper exemption is provided and validated.

*** All Credit Card transactions are subject to a 2% processing fee.

PRESENTED BY: Linda Ripper Sr. Account Specialist - Environmental Cell: 573-206-7938 Email: lripper@rehrig.com Date: 12/20/21	ACCEPTED BY: DAVID PEREZ 12/20/21 Sign and Print Name Title: PRESIDENT
--	---

To initiate order, please call or send signed proposal via fax or email to Procurement by representatives.

All Contents Placed In This Container (Including Trash) Will be Taken To Our Recycling Processing Facility And Sorted To Recover All Recyclables

Los Desechos Dentro De Este Contenedor (incluyendo Basura) Seran Transportados A Una Fabrica Para Procesar Y Recuperar De Materiales Reciclables



Valley Vista Services 800-442-6454
www.valleyvistaservices.com



ORGANICS ONLY

ACCEPTED

ALL Food Waste, including:

- Meat & Bones
- Cheese & Dairy Products
- Coffee Grounds & Filters
- Tea Leaves & Bags
- Egg Shells
- Fruits & Vegetables
- Bread & Baked Goods
- Pasta, Rice, Cereals and Grains
- Beans, Legumes, Nuts & Seeds
- Small Amounts of Food-Soiled Paper
- RPI Compostable Bags



Valley Vista Services
Waste Disposal and Recycling Division

NOT ACCEPTED

- Non-Compostable Plastic Bags, Utensils and Plates
- Polystyrene / Styrofoam
- Aluminum Foil Packaging
- Glass and Metal
- Wax-Coated Paper Plates, Cups & Liners
- Liquids
- Plastics Cups, Lids & Straws
- To-Go Containers

To request replacement and/or additional containers, contact:

Valley Vista Services
Monday - Friday
8:00 a.m. to 5:00 p.m.
(800) 442-6454
ValleyVistaServices.com

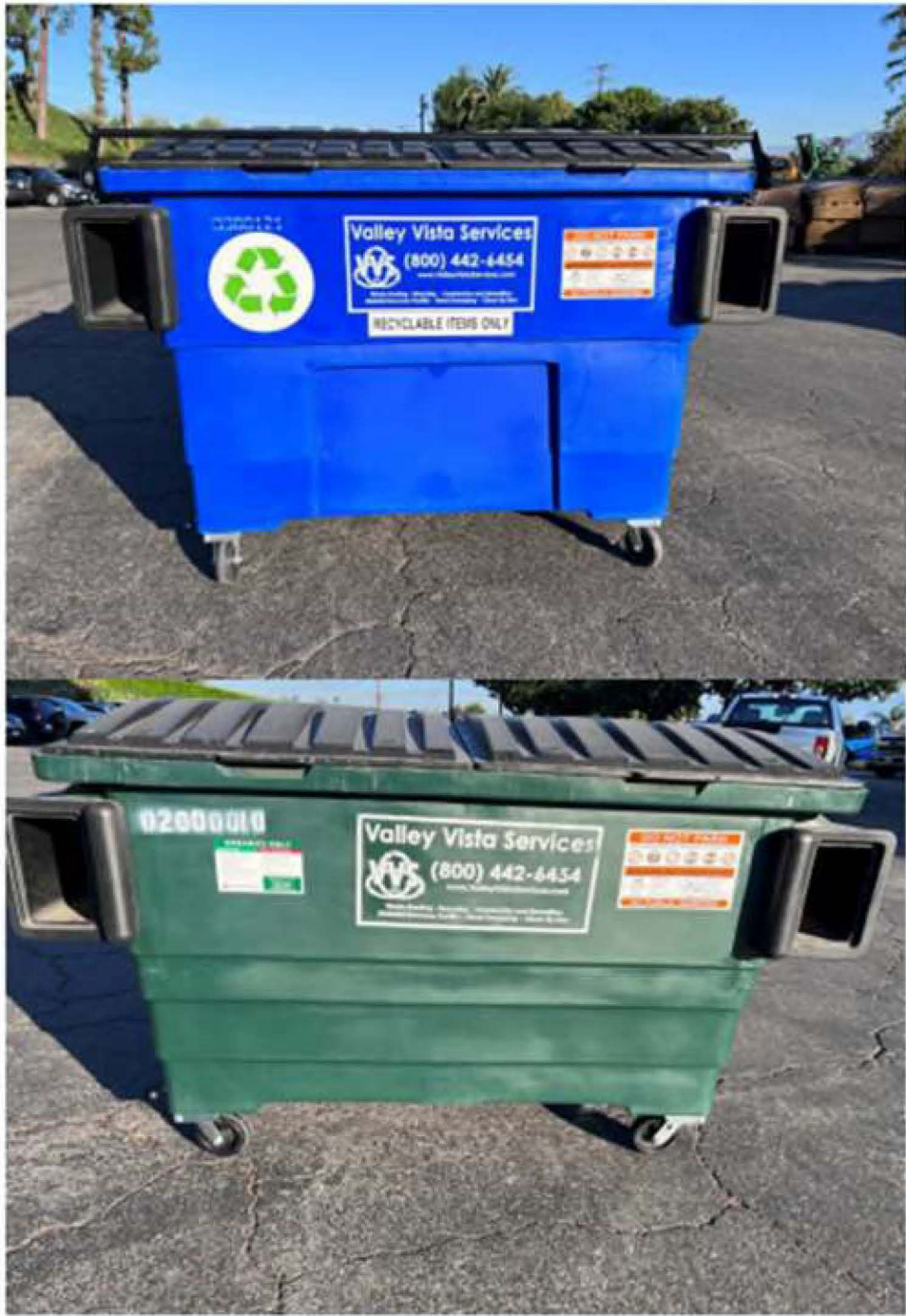





Kitchen Pail-



Exhibit 17 – Contractor Documentation

Item A.3 - Vehicle Specifications

This item consists of 3 pages (including this page).

The vehicles listed below are assigned to perform Collection services in the East San Gabriel, Puente Hills, and Gateway service areas.

Collection Vehicles List

Vehicle number	Fuel	Model	Description	Year	Make	Material
225	CNG	LET	FRONT END LOADER	2012	CCC	ORG
226	CNG	LET	FRONT END LOADER	2012	CCC	ORG
227	CNG	LET	FRONT END LOADER	2012	CCC	ORG
228	CNG	LET	FRONT END LOADER	2012	CCC	ORG
260	CNG	LET	FRONT END LOADER	2022	CCC	MSW
261	CNG	LET	FRONT END LOADER	2022	CCC	MSW
262	CNG	LET	FRONT END LOADER	2022	CCC	MSW
263	CNG	LET	FRONT END LOADER	2022	CCC	MSW
264	CNG	LET	FRONT END LOADER	2022	CCC	MSW
265	CNG	LET	FRONT END LOADER	2022	CCC	MSW
266	CNG	LET	FRONT END LOADER	2022	CCC	MSW
267	CNG	LET	FRONT END LOADER	2022	CCC	RECYC
268	CNG	LET	FRONT END LOADER	2022	CCC	RECYC
269	CNG	LET	FRONT END LOADER	2022	CCC	RECYC
270	CNG	LET	FRONT END LOADER	2022	CCC	RECYC
1003	GAS	F250	BIN DELIVERY	2022	FORD	
1004	GAS	F250	BIN DELIVERY	2022	FORD	





1815
 1815 (916) 750-1000
 1815 (916) 750-1000
 1815 (916) 750-1000

Buyers Order

Deal#: DE-69445
 Opp#: 2022-138933
 Date: 01/10/2022

www.velocitytruckcenters.com

Contact: Ron Creighton - Mobile: 562/750-6106 - Email: RCreighton@vgttruck.com

To: 128649 VALLEY VISTA SERVICES 17444 East Railroad St City of Industry CA 91748 County: Los Angeles Phone: (626) 961-6291 FAX: (626) 961-1105 DavidPerez@Valleyvistaservices.com	Attn:
--	-------

Unit#	Stock#	Description	Price
VIN: FACTORY ORDE0		New 2022 CRANE CARRIER LET2-40 GVW: 57500	\$195,861.00
To Be Delivered On or About: 07/18/2022			Unit Price: \$195,861.00
Color:	24316EX-YELLOW		
Unit#	Stock#	Description	Price
VIN: FACTORY ORDE1		New 2022 CRANE CARRIER LET2-40 GVW: 57500	\$195,861.00
To Be Delivered On or About: 07/18/2022			Unit Price: \$195,861.00
Color:	24316EX-YELLOW		
Unit#	Stock#	Description	Price
VIN: FACTORY ORDE2		New 2022 CRANE CARRIER LET2-40 GVW: 57500	\$195,861.00
To Be Delivered On or About: 07/18/2022			Unit Price: \$195,861.00
Color:	24316EX-YELLOW		
Unit#	Stock#	Description	Price
VIN: FACTORY ORDE3		New 2022 CRANE CARRIER LET2-40 GVW: 57500	\$195,861.00
To Be Delivered On or About: 07/18/2022			Unit Price: \$195,861.00
Color:	24316EX-YELLOW		
Unit#	Stock#	Description	Price
VIN: FACTORY ORDE4		New 2022 CRANE CARRIER LET2-40 GVW: 57500	\$195,861.00
To Be Delivered On or About: 07/18/2022			Unit Price: \$195,861.00
Color:	24316EX-YELLOW		
Unit#	Stock#	Description	Price
VIN: FACTORY ORDE5		New 2022 CRANE CARRIER LET2-40 GVW: 57500	\$195,861.00
To Be Delivered On or About: 07/18/2022			Unit Price: \$195,861.00
Color:	24316EX-YELLOW		
Unit#	Stock#	Description	Price
VIN: FACTORY ORDE6		New 2022 CRANE CARRIER LET2-40 GVW: 57500	\$195,861.00
To Be Delivered On or About: 07/18/2022			Unit Price: \$195,861.00
Color:	24316EX-YELLOW		
Unit#	Stock#	Description	Price
VIN: FACTORY ORDE7		New 2022 CRANE CARRIER LET2-40 GVW: 57500	\$195,861.00
To Be Delivered On or About: 07/18/2022			Unit Price: \$195,861.00
Color:	24316EX-YELLOW		
Unit#	Stock#	Description	Price
VIN: FACTORY ORDE8		New 2022 CRANE CARRIER LET2-40 GVW: 57500	\$195,861.00
To Be Delivered On or About: 07/18/2022			Unit Price: \$195,861.00
Color:	24316EX-YELLOW		

ONLY THESE TERMS AND SERVICES APPLY TO THIS ORDER AND ENCLOSED IN THE ORDER FORM.
 ALL OTHERS, INCLUDING THE STANDARD TERMS AND CONDITIONS OF SALE, ARE HEREBY REJECTED.
 The undersigned hereby agrees to the terms and conditions of this agreement, including the terms and conditions of any order concerning this purchase has been made or entered into, or will be completed. I hereby certify that no credit has been extended to me for the purchase of this motor vehicle unless so agreed in writing on the face of this agreement. I have read and understand the final page of this agreement and agree to it as a part of this order. The date on it is true and correct above my signature. I certify that I am of legal age, or older, that I have legal capacity and authority to execute this agreement on behalf of my company, and hereby acknowledge receipt of a copy of this notice.

VALLEY VISTA SERVICES (Customer's Name) _____ (Customer's Signature) _____ Date: 3/21/22	Ron Creighton (Salesperson Name) _____ (Salesperson Signature) _____ Title:
--	---

Exhibit 17 – Contractor Documentation

Item A.4 - Subcontractors

This item consists of 2 pages (including this page).

VVS will not be utilizing any subcontractors

Exhibit 17 – Contractor Documentation

Item A.5 - Office Address

This item consists of 2 pages (including this page).

Item A.5 – OFFICE

1. Valley Vista Services, Inc.
17445 E Railroad Street
City of Industry, Ca 91748

Phone (800) 442-6454

Hours: Monday through Friday – 7:00 a.m. to 5:00 p.m.
Saturday – 7:00 a.m. to 1:00 p.m.

2. Repair Shop
1037 Hatcher Avenue
City of Industry, CA 91748
3. Vehicle Yard
1037 Hatcher Avenue
City of Industry, CA 91748

Exhibit 17 – Contractor Documentation

Item B.1 - Form of Non-Collection Notice (Item A5 of Exhibit 3A1)

This item consists of 3 pages (including this page).



Valley Vista Services
Your Waste Disposal and Recycling Specialists
Serving Southern California Since 1957
 17445 East Railroad St., City of Industry, CA 91748
(800) 442-6454
 www.valleyvistaservices.com

Dear Customer,
 Your Container was not serviced due to the following reason(s):

CONTAMINATION

- 1 Palm Leaves
- 2 Bird of Paradise
- 3 Cactus
- 4 Yucca Plants
- 5 Plastic Bags
- 6 Trash
- 7 Lumber
- 8 Dirt / Concrete / Rock
- 9 Hazardous Substance
- 10 Roofing Materials

Please remove the contaminated materials and prepare the container for the next scheduled pickup.

If you require more immediate service, please contact our office at the above number.

OTHER

- 11 Container Overfilled
- 12 Barrels Not Set Out Properly
- 13 Container Blocked
- 14 Container Overweight
- 15 Account Past Due / Service Interrupted

Please correct the condition before your next scheduled pickup. If you have any questions or require assistance, please feel free to contact our office.

M-F: 8:00 am - 5:00 pm or Sat.: 8:00 am - 1:00 pm
 or e-mail us: customerservice@valleyvistaservices.com

BBL #: _____

Dumped Not Dumped

Address: _____

Date: _____ Time: _____

Problem Code: 1 2 3 4 5 6

7 8 9 10 11 12 13 14 15

Comment: _____



Valley Vista Services
Your Waste Disposal and Recycling Specialist
Serving Southern California Since 1957
 17445 East Railroad St., City of Industry, CA 91748
(800) 442-6454
 www.valleyvistaservices.com

COMMERCIAL SERVICE

Dear Customer,

We were here on ____/____/____, but were unable to service your container due to the following reason(s):

- 1. **CONTAINERS BLOCKED**
 We were unable to service the container(s) because they were blocked by:
 A) Vehicle B) Trash C) Other
- 2. **CONTAINER OVERFILLED**
 For safety reasons, the container must be filled no higher than the top of the container.
- 3. **TRASH OUTSIDE OF CONTAINER**
 All trash must be placed inside of the container prior to service.
- 4. **PAST DUE ACCOUNT/SERVICE INTERRUPTED**
 Account is Past Due or payments have not been made in a timely manner.
- 5. **CONTAINER OVERWEIGHT**
 For safety reasons, the maximum weight allowed is 500 lbs.
- 6. **NO LIQUID OR HAZARDOUS WASTE**
 For safety reasons, we cannot accept any hazardous or liquid wastes in this container.
 Please call our customer service center for further information.
- 7. **RECYCLING CONTAINER CONTAMINATED**
 Non-recyclable material in container.
- 8. **CONTAINER NOT OUT DURING PICK UP HOURS**
 Hours: _____

Please correct the condition before your next scheduled pickup. If you have any questions or require assistance, please feel free to contact our office.

M-F: 8:00 am - 5:00 pm or Sat.: 8:00 am - 1:00 pm
 or e-mail us: customerservice@valleyvistaservices.com

Address: _____ City: _____

Driver: _____ Route: _____ Date: _____

- 1. Container Blocked
 (A - Vehicle B - Trash C - Other)
- 2. Container Overfilled
- 3. Trash Outside of Container
- 4. Past Due Account
- 5. Container Overweight
- 6. No Liquid or Hazardous Waste
- 7. Recycling Container Contaminated
- 8. Container Not Out During Pick Up Hours

Vehicle License #: _____

By: _____



Valley Vista Services

Waste Disposal and Recycling

17445 East Railroad St., City of Industry, CA 91748

Servicing Southern California Since 1957

(800) 442-6454

Dear Customer,
Your Container was not serviced due to the following reason(s):

- 1 Contaminated with Trash
- 2 Hazardous Substance
- 3 Overweight
- 4 Container Blocked
- 5 Timely Payments
- 6 Other: _____

Please correct the condition before your next scheduled pickup. If you have any questions or require assistance, please feel free to contact our office.

M-F 7:00 am to 5:00 pm

Sat. 8:00 am to 1:00 pm

BBL #: _____

Dumped Not Dumped

Address: _____

Date: _____ Time: _____

Problem Code: 1 2 3 4 5 6

Comment: _____



Valley Vista Services

Waste Disposal and Recycling

17445 East Railroad St., City of Industry, CA 91748

Servicing Southern California Since 1957

(800) 442-6454

Estimado Cliente,
Su contenedor no se le dio servicio por la siguiente razon(es):

- 1 Contaminado con Basura
- 2 Materiales Peligrosos
- 3 Sobrepesado
- 4 Contenedor Bloqueado
- 5 Pagos No a Tiempo/El Servicio Interrumpido
- 6 Otro: _____

Por favor corrija lo indicado antes de su proximo dia de servicio. Si tiene alguna pregunta o requiere asistencia por favor de comunicarse a nuestra oficina.

L-V 7:00 am to 5:00 pm

Sab. 8:00 am to 1:00 pm

Exhibit 17 – Contractor Documentation

Item B.2 - Waiver of Liability

This item consists of 2 pages (including this page).

Waiver of Liability

GENERAL RELEASE AND WAIVER OF LIABILITY FOR DAMAGE TO PRIVATE DRIVEWAYS AND PAVEMENT

1. **PERMISSION TO ENTER.** Customer allows Valley Vista Services, its assigns, employees, agents, and subcontractors ("**Service Providers**") to enter and/or utilize the premises of the undersigned Customer ("**Customer's Premises**") for the purposes of providing the solid waste services described on the attached Subscription Order ("**Services**").

This release excludes all liability resulting from Service Provider's negligence and willful acts or omissions. The Service Provider is obligated and liable to Customer under Service Provider's Contract with the COUNTY OF LOS ANGELES, including to repair or replace, to customer's satisfaction, damaged property, and to reimburse customer's cost of personal injury, caused by Service Provider's negligence or willful acts or omissions.

2. **BINDING.** This acknowledgement, hold harmless, and release/assumption of risk shall be binding on all of Customer's successors and administrators.

In signing this permission and release/assumption of risk/waiver, I hereby acknowledge and represent:

- a. That I have read this release, understand it and sign it voluntarily; and
- b. That I am the legal customer of the premises at the address provided below

For: Customer

For: Valley Vista Services

Printed

Printed

Date

Date

Customer's Premises Address: _____ **OR**

Address of location where trash bin or container was placed:
(If different from address above)

Name/Title of Customer's Authorized Agent/Representative:

Signature of Customer's Authorized Agent/Representative:

Date: _____

Exhibit 17 – Contractor Documentation

Item B.3 - Terms and Conditions Summary (Item I1 of Exhibit 3A1)

This item consists of 12 pages (including this page).

Puente Hills Service Area

COMMERCIAL TRASH, RECYCLING, AND ORGANIC WASTE COLLECTION SERVICES

SECTION 2 - CUSTOMER SUBSCRIPTION ORDER

To Our Valued Customer: The County of Los Angeles Board of Supervisors (County) awarded Valley Vista Services, Inc. a ten-year exclusive contract to provide commercial trash, recycling and organic waste collection service within the unincorporated community of **Puente Hills** starting on October 1, 2022 and ending September 31, 2032. Valley Vista Services takes great pride in the work we do to keep the environment clean and protected for our future.

This subscription is subject to our being a franchised waste hauler under the County's exclusive commercial franchise contract. Its term is ten (10) years *unless you terminate service*. You may terminate service at any time by giving us 14 days' notice, your notice must include a reason for the termination. We will refund any advanced payment for service after termination. We will provide a written final notice (postmarked at least 14 days in advance) if we are to suspend or terminate your service. The final notice will include an explanation for the suspension or termination and information on how to resolve your issue and restart service. For a general copy of your Bill of Rights, please visit www.LACountySWIMS.org/BOR.

CONTAINER TYPES, SIZES AND STANDARD SERVICE RATES

Please review the service option that you ordered and the rates we will charge you (on or after October 1, 2022), marked below. We will bill you (MONTHLY):

<u>SOLID WASTE TYPE</u>	<u>CONTAINER TYPE (Cart, Dumpster or Roll-off)</u>	<u>QTY & CONTAINER SIZE</u>	<u>COLLECTION FREQUENCY / WEEK</u>							
			<u>1.</u>	<u>2.</u>	<u>3.</u>	<u>4.</u>	<u>5.</u>	<u>6.</u>	<u>7.</u>	
			X							
Trash and Recycling (Black Container)	Dumpster	1 - 3 yd	\$130.00							
Organic Waste (Green Container)										
Other:										

ADDITIONAL STANDARD SERVICES

All Customers will receive:

- Black Container – One (1) Allows for the collection of refuse and recycling materials
 - Additional or larger containers available upon request at an additional cost
- Green Container– One (1) limited to the collection of organic waste only
 - The minimum base rate for refuse includes the equivalent of a 64-gallon cart of weekly organic waste collection service per customer at no additional charge unless the customer requires service beyond the minimum.
 - Additional or larger containers available upon request at an additional cost
- Container Cleanings

- One (1) free container cleaning or container change out per 12-month period, per container
- Container Exchanges
 - One (1) free annual exchange of containers for different sizes

Site Visits and Waste Assessments

- All customers will receive a site visit and waste assessment upon start of collection services. Ongoing site visits and waste assessments shall be provided every other year thereafter or as needed.

Residential and Multifamily Customers will receive:

- In-home Food Waste Container (Limited one (1) per occupant)
- Free Holiday Tree Collection Services and Sharps collection
- Free annual on-call bulky item collections. The maximum amount of collections allotted depends on the number of units on the premises. (Single-family is considered one (1) unit)

Businesses will receive:

- Up to six (6) On-call bulky Item collections per year

DISCOUNT SERVICES

- 25% Senior Discount

EXTRA SERVICES

- Available Upon Request (See Attachment)

To request additional services, ask questions or express concerns, please call our customer service department:

EXTRA SERVICES FEES

Extra Service	Description	Fee
Locks		
Padlock	Upon Customer Request	\$11.50 (one-time, per Container)
Gravity Lock	Upon Customer Request	\$15.00 (one-time, per Container)
Lock Bar	Upon Customer Request	\$15.00 (one-time, per Container)
Service		
Roll-out	Upon Customer Request	\$5.00 per collection event \$3.00 per container (beyond first container)
	25-50 ft	\$14.00 per collection event \$7.00 per container (beyond first container)
		\$14.00 per collection event
Scout	51-75 ft	\$7.00 per container (beyond first container)
	76+ ft	\$14.00 per collection event \$7.00 per container (beyond first container)
Difficult to Service	For Customers that live in difficult to service areas including but not limited to: areas with narrow streets, alleys and bridges, one-way narrow streets, steep roadway gradients, etc.	\$11.00 per collection event \$8.00 per container (beyond first container)
Additional Bulky Item pickups for Multifamily and Residential Customers	After exceeding maximum Collections allowed per yr.	\$25.00 per pickup
Additional Bulky Item pickups for Commercial Customers	After exceeding 6 collections allowed per yr.	\$25.00 per pickup
Containers		

<u>Bear Resistant Containers</u> 96-Gallon Cart	Upon Customer Request	\$50.00 per month
<u>Bear Resistant Containers</u> Other Container size	Upon Customer Request	\$50.00 per month
Cleaning or Exchange of Containers for cleaning purposes	After one free cleaning per 12-month period	\$50.00 per Cart or Dumpster Container
		\$50.00 per Compactor Container
		\$50.00 per Roll-off Container
Extra Pickup Charge, beyond 1 allowed per year	Unscheduled collection due to non-collection events	\$65.00 per occurrence`
Container Violation Fee	For Unresponsive Customers or not rectified scenarios needing to collect Solid Waste materials subject to non-collection events	\$50.00 per occurrence
Contamination Fee	Upon observation and documentation of 3 rd contamination incident	\$50.00 per occurrence
Temporary Roll-off Daily Rental Fee (Excluding C&D)	Temporary Roll-off Daily Rental Fee	\$8 per day
Container Removal and Return within previous 12 months (Containers in Public-Right-of-Way)	For Removal of Carts or Dumpsters Stored in the Public Right-of-Way	\$75.00 First removal and return (per set) \$ <u>Additional 25% fee</u> Each additional removal and return (per set) \$75.00 Cleanup of Set-Out Site
Container Size Exchange, beyond 1 per year	Each additional exchange/delivery	\$75.00 Per each additional exchange
Construction and Demolition (C&D) Debris Roll-offs		
C&D Roll-off Containers	Upon Customer Request	<u>\$ Negotiate rate with Customer</u> per month

Manure Service		
64-Gallon Cart	Upon Customer Request	\$50.00 per month
1-CY Dumpster	Upon Customer Request	\$175.00 per month
2-CY Dumpster	Upon Customer Request	\$275.00 per month
In-Home Food Waste Container		
Additional in-home Food Waste Containers (First one Free)	Upon Customer Request	\$15.00 per Container
Green Waste Service		
Green Waste only Containers (Carts and Dumpsters)	Upon Customer Request	<u>\$ Negotiate rate with Customer</u> per month
Billing		
Late Payment Fee	If payment is not received by the last day of the second month, the account will become delinquent, and a late fee will be assessed	10% of past due amount
Service Interruption	Additional Charge for Collection Services Interruption (returning containers back to premises)	\$25.00
Returned Checks	Additional Charge for Customer returned checks (insufficient funds)	\$25.00

CUSTOMER SERVICE

Monday thru Friday 8:00 a.m. to 5:00 p.m. at (800) 442-6454 and
CustomerService@myws.com

EXCLUSIVE COMMERCIAL FRANCHISE | CUSTOMER BILL OF RIGHTS

What We Will Collect. We will collect trash (also known as refuse), organic waste, and commingled recyclables in the containers we provide. You must place refuse, recyclable materials, and organic waste in the appropriate collection containers. We may not pick up materials that are discarded outside of containers and as such may be considered a non-collection event unless you have made previous arrangements with us, as described below.

Mandatory Organic Waste Collection Services. The Los Angeles County Board of Supervisors adopted the Mandatory Organic Waste Disposal Reduction Ordinance, which enforces all persons (residents and business/property owners) in the County unincorporated communities to subscribe to organic waste collection services. To comply with this law, you may self-haul, self-manage organic waste on site, utilize an authorized Micro-Hauler (Limited to Organic Waste Collection Only), or you may choose to receive organic waste collection services with us. Additionally, all our customers will be provided weekly organic waste collection services along with their weekly refuse collection services. The minimum base rate for refuse includes the equivalent of a 64-gallon cart of weekly organic waste collection service per customer at no additional charge unless the customer requires service beyond the minimum. Should you need more containers, we can offer a variety of sizes at a cost. Please contact us for your needs.

Mandatory Commercial Recycling. Commercial businesses and multifamily residences (of 5 or more units) that generate four (4) cubic yards or more of solid waste per week are required by California law to recycle. To comply with the law, you may donate or sell any of, or all, your recyclables elsewhere, such as recycling centers or reuse enterprises, or subscribe to recycling services with us. Additionally, all our customers will be provided weekly recycling and refuse collection services. Every customer will be provided a black container that will collect both refuse and recycling materials together. The discarded materials in the black container that collects both refuse and recyclable materials will be taken to a processing facility to separate refuse from recyclable materials. Larger containers will be offered at half the rate for the same type and capacity of refuse container and same frequency of a refuse collection service. To evaluate and determine whether your existing levels of refuse, recycling, and organic waste services are appropriate, and promote and implement recycling services, a free site visit and waste assessment will be provided upon the start of collection services. Ongoing site visits and waste assessments will be provided every other year thereafter or as needed.

We Will Not Collect Hazardous Waste. State law prohibits disposal of hazardous materials in your collection containers. Hazardous waste includes most paints, pesticides, petroleum derivatives such as motor oil and solvents, batteries, thermostats, aerosol cans, fluorescent lights, and certain mercury-containing devices. If we identify these items in your containers, we will tag your containers

and they will not be collected. For additional safe and legal disposal options, call 1 (888) CLEAN LA or visit www.CleanLA.com.

When We Will Collect. We will collect your containers on your scheduled collection day(s) each week. We will notify you in advance if we make a permanent change in your scheduled collection day. If your scheduled collection day falls on or after a holiday, or during a holiday week, collection will be delayed by one (1) day. (Friday customers will receive their collection on Saturday.) We observe the following holidays: Memorial Day, Independence Day, Labor Day, Thanksgiving, Christmas, and New Year's Day.

Where We Will Pick Up. You must set your containers(s) at the set-out site as agreed upon unless you have roll-out/scout service. If we agreed to collect on private driveways or pavement, we will ask you to sign a waiver of damage liability. We must repair or replace, to your satisfaction, damaged property, and reimburse you for cost of personal injury caused by our negligence or willful acts or omissions. In addition to enforcing your rights under the franchise agreement, you may institute civil suits allowed under law.

Container Enclosure Maintenance and Litter. You are responsible for keeping your container enclosure or set-out site clean and in good repair. We will clean up all litter caused during collection.

Weight Limitations of Carts or Dumpsters.

The weight limits for each automated cart are as follows:

- 100 lbs. for 96-gallon carts
- 80 lbs. for 64-gallon carts
- 60 lbs. for 32-gallon carts

The weight limits for each dumpster are as follows:

- 250 lbs. for 2yds dumpsters
- 350 lbs. for 3yds dumpsters
- 450 lbs. for 4yds dumpsters
- 600 lbs. for 6yds dumpsters

If carts or dumpsters are found to be over these weight limits, they will be tagged and not serviced.

Repair/Replacement. At no additional charge, we will repair or replace damaged containers within two service days after we have observed damaged containers while providing service and upon your request unless the container damage is deemed to be due to customer negligence.

Bulky Items and Electronic Waste Pickups for Multifamily and Residential Customers.

We will provide a specified maximum amount of bulky item pickups per year at no charge (limit of ten (10) items per pickup) based on the number of units on the premises, as specified in the chart below.

Residential and Multifamily Premises with Number of Units	Maximum Collection Pickups (no additional cost to Customer)
MF Premises with 150+ units	Up to 50 per year No Charge

MF Premises with 101-149 units	Up to 40 per year No Charge
MF Premises with 50-100 units	Up to 30 per year No Charge
MF Premises with 25-49 units	Up to 20 per year No Charge
MF Premises with 1-24 units *1-unit accounts for a Residential Customer	Up to 10 per year No Charge

Examples of bulky items include discarded furniture (such as chairs, sofas, mattresses, box springs, and rugs), appliances (such as refrigerators, ranges, washers, dryers, water heaters, dishwashers, plumbing), and other similar items. Electronic waste includes "covered electronic devices" such as cathode ray tubes (as in TV and computer monitors), LCD and plasma screens, and electrically powered equipment such as computers, telephones, answering machines, radios, stereo equipment, tape players/recorders, phonographs, videocassette players/recorders, and calculators.

The collection of special recyclable and reusable items such as textiles, wood and lumber are also included.

Bulky Items and Electronic Waste Pickups for Commercial Customers. We will make six (6) pickups of bulky items (limit of ten (10) items per pickup) and unlimited amounts of certain electronics at your request each year. If you call us at least 24 hours in advance, we will collect them on your next regularly scheduled pickup day.

When You Must Pay. We bill trash collection services monthly or quarterly in advance. We will mail your bill on or before the first day of your billing period, i.e., April 1st for the billing period of April, May, and June. Your bill is due no later than the last day of the first month. With this example, that would be April 30th. If we do not receive payment by the last day of the second month, i.e., May 31st, your bill will become delinquent and an additional 10% fee will be added to the balance. We may terminate your service if you do not pay your service fees by the end of the billing cycle, i.e., June 30th. We will charge \$25 to restart the service after a service interruption and a \$25 fee on returned checks.

Refunds. We will refund any overcharges (including advance payments for services that you subsequently cancel) within 30 days after we receive them. We will pay you interest on overcharges (other than advance payments for subsequently canceled services) at 10% per annum from the date of the overcharge until the date refunded.

Third Party Services. Customers have the option to obtain extra services such as: roll-out and scout service through another service provider.

Customer Termination Rights and Right to Self-haul. Within six (6) months of your new service, we will amend any written subscription order you may have with us to grant you your customer termination rights. You may terminate service at any time by giving us 14-days' notice, your notice must include a reason for the termination. You also have the right to self-haul some of, or all, your solid waste in addition to, or instead of, subscribing to our service.

Customer Notification. We will provide a written final notice (postmarked at least 14 days in advance) if we are to suspend or terminate your service. The final notice will include an explanation for the suspension or termination and information on how to resolve your issue and restart service.

Where You Can Contact Us. You may call us toll-free regarding service or complaints at **(800) 442-6454** between **8:00 am and 5:00 pm** on weekdays, except on holidays. You may come to our office located at **17445 E Railroad Street, Industry, CA 91748**, mail correspondence to our office address or e-mail us at customerservice@myvvs.com. If we do not satisfactorily resolve any complaint, you may call Los Angeles County Public Works at 1-888-253-2652.

We Do Not Discriminate. If you are entitled to service, we will not discriminate against you on account of race, creed, color, sex, gender, national origin, ancestry, religion, age, physical or mental disability, marital status, or political affiliation.

Rights Of Privacy. We will observe and protect your rights of privacy and trade secrets. Unless you give us permission, we will not reveal any information identifying you or the composition or contents of your solid waste to any person except the County, or as required by law.

Thank You for Allowing **Valley Vista Services** to Serve You!

Exhibit 17 – Contractor Documentation

Item B.4 - Unpermitted Waste Screening Protocol (Section 13)

This item consists of 4 pages (including this page).

A. PROTOCOL

Valley Vista Services shall develop and implement the Un-Permitted Waste Screening Protocol included in the Franchise documentation in compliance with Applicable Law and including at a minimum:

1. Ongoing Employee Training in Identification

As a part of Valley Vista Services ongoing training program, all drivers, swamper and route personnel are required to attend monthly and quarterly tailgate safety meetings. During these meetings, we also conduct training sessions to educate employees on our safety policies, notification procedures, and household hazardous waste. Drivers are trained in both identification procedures and notification procedures when Un-Permitted waste is discovered. Drivers discovering Un-Permitted waste are instructed to complete a NonCollection notice, place one copy on the container (whenever safe) and file the second copy at the office.

2. Driver Inspection

Based on our experience, the automated curbside collection process can hamper visual identification of Un-Permitted waste. For this reason, Valley Vista Services has installed camera monitors on each automated vehicle. This additional step gives the driver/operator a clear visual of the contents of each container before it is commingled with the load.

3. Immediate Driver Response

While unloading the collection container into the holding hopper the driver has a clear view of the waste products as they are emptied and staged for compaction. All drivers are trained and prepared to segregate materials upon identification. Un-Permitted materials such as U-Waste or Household Hazardous Waste or any suspicious unidentified materials shall be left at the service address and a Noncollection tag shall be affixed to the container. Should any material appear to be dangerous in nature or a threat to the health and safety of the community or Valley Vista Services personnel, the area route supervisor shall immediately notify the County fire department and the appropriate local agency for immediate resolution.

4. Driver Notification

All Valley Vista Services drivers are trained and prepared to deal with any UnPermitted waste issue. Valley Vista Services personnel have been instructed to complete the non-collection tag and affix it to the offending container. The notification tag shall explain the violation and the proper means of disposal. All drivers are trained and prepared to segregate materials upon identification. Each Un-Permitted disposal incident shall be reported to the dispatch center and the area route supervisor. The service address shall

be monitored, if necessary, for additional disposal violations. Valley Vista Services customer service shall log each incident and supply a copy to the County of Los Angeles. Should any material appear to be dangerous in nature or a threat to the health and safety of the community or Valley Vista Services personnel, the area route supervisor will immediately notify the County fire department and the appropriate local agency for immediate resolution.

5. Notification of Appropriate Agency or Department

Valley Vista Services shall maintain a complaint and incident log for the Hacienda Heights franchise area. Customer Service shall monitor and record all Un-Permitted waste violations/incidents identified by Valley Vista Services personnel. All records shall be copied and supplied to the County of Los Angeles per the requirements of the franchise agreement. Valley Vista Services shall report its observations to the Director in addition to notifying the offender. Habitual violators shall be reported to the County inspector and service may be suspended pending final resolution. Should any material appear to be dangerous in nature or a threat to the health and safety of the community or by Valley Vista Services personnel, the area route supervisor will immediately notify the County fire department and the appropriate local agency for immediate resolution.

6. Appropriate Actions

Valley Vista Services is committed to proper manifestation and management of Un-Permitted waste materials. In the event suspicious material is identified, the area route supervisor will be immediately notified and proper containment materials will be applied. All collected materials will be properly containerized, removed, and transported by a license contractor in accordance with Applicable Law.

7. Compliance with Applicable Law

Valley Vista Services will comply with all Local, State and Federal laws as outlined in on compliance standards defined in the Department of Transportation (DOT) (Title 49 CFR) and the United States Environmental Protection Agency Title 40 CFR, as well as with California EPA and DTSC regulations.

8. Form and Content of Labels

Each automated cart contains language and illustrations prohibiting customers from discarding Un-Permitted Waste in English, Mandarin and Spanish. The final content of this information has been approved by the County of Los Angeles and was paid for and distributed by Valley Vista Services or its contractor.

B. Prohibition on Collection

Unless licensed in accordance with Applicable Law, Valley Vista Services, is prohibited from collecting Un-Permitted waste, other than in connection with providing collection of bulky items, CEDS, or E-waste as outlined in the Hacienda Heights Franchise

Agreement. Valley Vista Services will notify all persons required by Applicable Law of Unpermitted Wastes that it finds or observes in Solid Waste.

C. Reports to Director

Valley Vista Services shall use Reasonable Business Efforts to report to the Director and the appropriate agency as required by Applicable Law any observance of suspicious materials it reasonably believes or suspects to contain Un-Permitted Waste being disposed of or released onto any County or any other public property, including storm drains, streets, or other public rights of way.

D. Labels

Valley Vista Services shall affix labels to each automated cart used in the Hacienda Heights franchise area, with language and illustrations prohibiting customers from discarding Un-Permitted Waste in English, Mandarin and Spanish.

E. Safe Disposal Customer Education Program

As part of the Valley Vista Services Un-Permitted Waste Screening Protocol, Valley Vista Services shall develop and implement a customer education program to maximize exclusion of Un-Permitted Waste from disposal and promote safe handling of Un-Permitted Waste as stipulated in Part II Section 6 Valley Vista Services shall distribute this education program in conjunction with its customer outreach for the Waste Diversion Program. Valley Vista Services shall submit the materials to COUNTY at least one month prior to distributing them for the approval of format and content. Materials shall be developed and circulated once each calendar year in accordance with the terms and conditions outlined in Part II Section 6 of the

Agreement.

Valley Vista Services shall notify the subscribers regarding the safe handling of Un-Permitted Waste through our community outreach efforts. Unsafe disposal of Un-Permitted Waste will be strongly discouraged. Any items deemed to be hazardous waste, U-Waste, or E-Waste will not be collected in the regular cart collection program. Should such material be presented at the curb, a Non-Collection Notice will be affixed to the cart

Exhibit 17 – Contractor Documentation

Item B.5 - Acknowledgment

This item consists of 2 pages (including this page).

Valley Vista Services, Inc., acknowledges that it has read and completely understands the program(s)

related to the Notification of Incidents, Claims, or Suits as articulated in the bid documents, Exhibit 5, B6.

Valley Vista Services, Inc., agrees to provide reporting on:

- A. Any accident or incident relating to the Contract Services involving injury or property damage that may result in the filing of an insurance claim, its legal claim, or lawsuit against CONTRACTOR, any Subcontractor, and/or COUNTY;
- B. Any third-Party claim or lawsuit filed against CONTRACTOR arising from or related to Contract Services;
- C. Any injury to a CONTRACTOR employee that occurs on COUNTY property, or,
- D. Any loss, disappearance, destruction, misuse, or theft of COUNTY property, money, or securities entrusted to CONTRACTOR.

Valley Vista Services, Inc., acknowledges it will submit its Report on a COUNTY "Nonemployee Injury Report" form available on COUNTY's website at :

<http://cao.co.la.ca.us/RMB/pdf/NonEmployeeInjuryReport.pdf>

And

Valley Vista Services, Inc., acknowledges that it has read and completely understands the program(s) related to the Safely Surrendered Baby Law as articulated in the bid documents and the County of Los Angeles website www.babysafela.org.

Valley Vista Services, Inc., agrees to provide each employee involved with the contract a copy of the "No Shame. No Blame. No Names." County program documentation, in both English and Spanish, as provided in the downloadable version on the County of Los Angeles website.

Valley Vista Services, Inc., and its contractors will post posters of copies of County of Los Angeles posters regarding the Safely Surrendered Baby Law in every facility where their employees are present.

Valley Vista Services, Inc., acknowledges receipt of fact sheet relating to the Non-Employee Injury Report form that is available on the County's website at:

http://ceo.lacounty.gov/RMB/pdf/Forms/cms1_044804.pdf

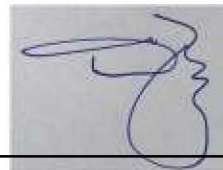

Signature

Exhibit 17 – Contractor Documentation

Item B.6 - Insurance and Performance Assurance (Part 4 of Exhibit 5 and Section 15)

This item consists of 44 pages (including this page).



ADDITIONAL REMARKS SCHEDULE

AGENCY Solid Waste Insurance Marketing	License # 0B29370	NAMED INSURED Valley Vista Services, Inc. 17445 East Railroad Street City Of Industry, CA 91748
POLICY NUMBER SEE PAGE 1		
CARRIER SEE PAGE 1	NAIC CODE SEE P 1	EFFECTIVE DATE: SEE PAGE 1

ADDITIONAL REMARKS

THIS ADDITIONAL REMARKS FORM IS A SCHEDULE TO ACORD FORM,
FORM NUMBER: ACORD 25 FORM TITLE: Certificate of Liability Insurance

Description of Operations/Locations/Vehicles:
Additional Named Insureds:
Zerap Management Corporation
Valley Vista Services, Incorporated
City of Industry Disposal Company, Inc.
Valley Vista Disposal
Vincent's General Services, Inc.
Valley Vista Services, Inc. DBA Valley Vista Services of Orange County
Grand Central Recycling & Transfer Station, Inc.
Municipal Maintenance, Inc.
Pomona Valley Transfer Station

Contract No. #003550; #003229; #003095

County of Los Angeles Department of Public Works, Its Special Districts, Elected Officials, Officers, Agents, Employees are included as additional insureds.

Additional Insured-Owners, Lessees or Contractors-Scheduled Person or Organization CG20101219
Business Auto - Additional Insured when required by contract or agreement - XIC4111013
Waiver of Transfer of Rights of Recovery Against Others to Us (Waiver of Subrogation) - CG24041219
Pollution Liability-Broadened Coverage for Covered Autos-Business Auto, Motor Carrier and Truckers Coverage Forms - CA99481013
Business Auto Coverage Form - CA00011013

COMMON POLICY CONDITIONS

All Coverage Parts included in this policy are subject to the following conditions.

A. Cancellation

1. The first Named Insured shown in the Declarations may cancel this policy by mailing or delivering to us advance written notice of cancellation.
2. We may cancel this policy by mailing or delivering to the first Named Insured written notice of cancellation at least:
 - a. 10 days before the effective date of cancellation if we cancel for nonpayment of premium; or
 - b. 30 days before the effective date of cancellation if we cancel for any other reason.
3. We will mail or deliver our notice to the first Named Insured's last mailing address known to us.
4. Notice of cancellation will state the effective date of cancellation. The policy period will end on that date.
5. If this policy is cancelled, we will send the first Named Insured any premium refund due. If we cancel, the refund will be pro rata. If the first Named Insured cancels, the refund may be less than pro rata. The cancellation will be effective even if we have not made or offered a refund.
6. If notice is mailed, proof of mailing will be sufficient proof of notice.

B. Changes

This policy contains all the agreements between you and us concerning the insurance afforded. The first Named Insured shown in the Declarations is authorized to make changes in the terms of this policy with our consent. This policy's terms can be amended or waived only by endorsement issued by us and made a part of this policy.

C. Examination Of Your Books And Records

We may examine and audit your books and records as they relate to this policy at any time during the policy period and up to three years afterward.

D. Inspections And Surveys

1. We have the right to:
 - a. Make inspections and surveys at any time;

- b. Give you reports on the conditions we find; and
- c. Recommend changes.

2. We are not obligated to make any inspections, surveys, reports or recommendations and any such actions we do undertake relate only to insurability and the premiums to be charged. We do not make safety inspections. We do not undertake to perform the duty of any person or organization to provide for the health or safety of workers or the public. And we do not warrant that conditions:
 - a. Are safe or healthful; or
 - b. Comply with laws, regulations, codes or standards.

3. Paragraphs 1. and 2. of this condition apply not only to us, but also to any rating, advisory, rate service or similar organization which makes insurance inspections, surveys, reports or recommendations.

4. Paragraph 2. of this condition does not apply to any inspections, surveys, reports or recommendations we may make relative to certification, under state or municipal statutes, ordinances or regulations, of boilers, pressure vessels or elevators.

E. Premiums

The first Named Insured shown in the Declarations:

1. Is responsible for the payment of all premiums; and
2. Will be the payee for any return premiums we pay.

F. Transfer Of Your Rights And Duties Under This Policy

Your rights and duties under this policy may not be transferred without our written consent except in the case of death of an individual named insured.

If you die, your rights and duties will be transferred to your legal representative but only while acting within the scope of duties as your legal representative. Until your legal representative is appointed, anyone having proper temporary custody of your property will have your rights and duties but only with respect to that property.

BUSINESS AUTO COVERAGE FORM

Various provisions in this policy restrict coverage. Read the entire policy carefully to determine rights, duties and what is and is not covered.

Throughout this policy the words "you" and "your" refer to the Named Insured shown in the Declarations. The words "we", "us" and "our" refer to the company providing this insurance.

Other words and phrases that appear in quotation marks have special meaning. Refer to Section V – Definitions.

SECTION I – COVERED AUTOS

Item Two of the Declarations shows the "autos" that are covered "autos" for each of your coverages. The following numerical symbols describe the "autos" that may be covered "autos". The symbols entered next to a coverage on the Declarations designate the only "autos" that are covered "autos".

A. Description Of Covered Auto Designation Symbols

Symbol	Description Of Covered Auto Designation Symbols	
1	Any "Auto"	
2	Owned "Autos" Only	Only those "autos" you own (and for Covered Autos Liability Coverage any "trailers" you don't own while attached to power units you own). This includes those "autos" you acquire ownership of after the policy begins.
3	Owned Private Passenger "Autos" Only	Only the private passenger "autos" you own. This includes those private passenger "autos" you acquire ownership of after the policy begins.
4	Owned "Autos" Other Than Private Passenger "Autos" Only	Only those "autos" you own that are not of the private passenger type (and for Covered Autos Liability Coverage any "trailers" you don't own while attached to power units you own). This includes those "autos" not of the private passenger type you acquire ownership of after the policy begins.
5	Owned "Autos" Subject To No-fault	Only those "autos" you own that are required to have no-fault benefits in the state where they are licensed or principally garaged. This includes those "autos" you acquire ownership of after the policy begins provided they are required to have no-fault benefits in the state where they are licensed or principally garaged.
6	Owned "Autos" Subject To A Compulsory Uninsured Motorists Law	Only those "autos" you own that because of the law in the state where they are licensed or principally garaged are required to have and cannot reject Uninsured Motorists Coverage. This includes those "autos" you acquire ownership of after the policy begins provided they are subject to the same state uninsured motorists requirement.
7	Specifically Described "Autos"	Only those "autos" described in Item Three of the Declarations for which a premium charge is shown (and for Covered Autos Liability Coverage any "trailers" you don't own while attached to any power unit described in Item Three).
8	Hired "Autos" Only	Only those "autos" you lease, hire, rent or borrow. This does not include any "auto" you lease, hire, rent or borrow from any of your "employees", partners (if you are a partnership), members (if you are a limited liability company) or members of their households.
9	Non-owned "Autos" Only	Only those "autos" you do not own, lease, hire, rent or borrow that are used in connection with your business. This includes "autos" owned by your "employees", partners (if you are a partnership), members (if you are a limited liability company) or members of their households but only while used in your business or your personal affairs.

19	Mobile Equipment Subject To Compulsory Or Financial Responsibility Or Other Motor Vehicle Insurance Law Only	Only those "autos" that are land vehicles and that would qualify under the definition of "mobile equipment" under this policy if they were not subject to a compulsory or financial responsibility law or other motor vehicle insurance law where they are licensed or principally garaged.
-----------	--	---

B. Owned Autos You Acquire After The Policy Begins

1. If Symbols **1, 2, 3, 4, 5, 6** or **19** are entered next to a coverage in Item Two of the Declarations, then you have coverage for "autos" that you acquire of the type described for the remainder of the policy period.
2. But, if Symbol **7** is entered next to a coverage in Item Two of the Declarations, an "auto" you acquire will be a covered "auto" for that coverage only if:
 - a. We already cover all "autos" that you own for that coverage or it replaces an "auto" you previously owned that had that coverage; and
 - b. You tell us within 30 days after you acquire it that you want us to cover it for that coverage.

C. Certain Trailers, Mobile Equipment And Temporary Substitute Autos

If Covered Autos Liability Coverage is provided by this Coverage Form, the following types of vehicles are also covered "autos" for Covered Autos Liability Coverage:

1. "Trailers" with a load capacity of 2,000 pounds or less designed primarily for travel on public roads.
2. "Mobile equipment" while being carried or towed by a covered "auto".
3. Any "auto" you do not own while used with the permission of its owner as a temporary substitute for a covered "auto" you own that is out of service because of its:
 - a. Breakdown;
 - b. Repair;
 - c. Servicing;
 - d. "Loss"; or
 - e. Destruction.

SECTION II – COVERED AUTOS LIABILITY COVERAGE

A. Coverage

We will pay all sums an "insured" legally must pay as damages because of "bodily injury" or "property damage" to which this insurance applies, caused by an "accident" and resulting from the ownership, maintenance or use of a covered "auto".

We will also pay all sums an "insured" legally must pay as a "covered pollution cost or expense" to which this insurance applies, caused by an "accident" and resulting from the ownership, maintenance or use of covered "autos". However, we will only pay for the "covered pollution cost or expense" if there is either "bodily injury" or "property damage" to which this insurance applies that is caused by the same "accident".

We have the right and duty to defend any "insured" against a "suit" asking for such damages or a "covered pollution cost or expense". However, we have no duty to defend any "insured" against a "suit" seeking damages for "bodily injury" or "property damage" or a "covered pollution cost or expense" to which this insurance does not apply. We may investigate and settle any claim or "suit" as we consider appropriate. Our duty to defend or settle ends when the Covered Autos Liability Coverage Limit of Insurance has been exhausted by payment of judgments or settlements.

1. Who Is An Insured

The following are "insureds":

- a. You for any covered "auto".
- b. Anyone else while using with your permission a covered "auto" you own, hire or borrow except:

- (1) The owner or anyone else from whom you hire or borrow a covered "auto".

This exception does not apply if the covered "auto" is a "trailer" connected to a covered "auto" you own.

- (2) Your "employee" if the covered "auto" is owned by that "employee" or a member of his or her household.
 - (3) Someone using a covered "auto" while he or she is working in a business of selling, servicing, repairing, parking or storing "autos" unless that business is yours.
 - (4) Anyone other than your "employees", partners (if you are a partnership), members (if you are a limited liability company) or a lessee or borrower or any of their "employees", while moving property to or from a covered "auto".
 - (5) A partner (if you are a partnership) or a member (if you are a limited liability company) for a covered "auto" owned by him or her or a member of his or her household.
- c. Anyone liable for the conduct of an "insured" described above but only to the extent of that liability.

2. Coverage Extensions

a. Supplementary Payments

We will pay for the "insured":

- (1) All expenses we incur.
- (2) Up to \$2,000 for cost of bail bonds (including bonds for related traffic law violations) required because of an "accident" we cover. We do not have to furnish these bonds.
- (3) The cost of bonds to release attachments in any "suit" against the "insured" we defend, but only for bond amounts within our Limit of Insurance.
- (4) All reasonable expenses incurred by the "insured" at our request, including actual loss of earnings up to \$250 a day because of time off from work.
- (5) All court costs taxed against the "insured" in any "suit" against the "insured" we defend. However, these payments do not include attorneys' fees or attorneys' expenses taxed against the "insured".
- (6) All interest on the full amount of any judgment that accrues after entry of the judgment in any "suit" against the "insured" we defend, but our duty to pay interest ends when we have paid, offered to pay or deposited in court the

part of the judgment that is within our Limit of Insurance.

These payments will not reduce the Limit of Insurance.

b. Out-of-state Coverage Extensions

While a covered "auto" is away from the state where it is licensed, we will:

- (1) Increase the Limit of Insurance for Covered Autos Liability Coverage to meet the limits specified by a compulsory or financial responsibility law of the jurisdiction where the covered "auto" is being used. This extension does not apply to the limit or limits specified by any law governing motor carriers of passengers or property.
- (2) Provide the minimum amounts and types of other coverages, such as no-fault, required of out-of-state vehicles by the jurisdiction where the covered "auto" is being used.

We will not pay anyone more than once for the same elements of loss because of these extensions.

B. Exclusions

This insurance does not apply to any of the following:

1. Expected Or Intended Injury

"Bodily injury" or "property damage" expected or intended from the standpoint of the "insured".

2. Contractual

Liability assumed under any contract or agreement.

But this exclusion does not apply to liability for damages:

- a. Assumed in a contract or agreement that is an "insured contract", provided the "bodily injury" or "property damage" occurs subsequent to the execution of the contract or agreement; or
- b. That the "insured" would have in the absence of the contract or agreement.

3. Workers' Compensation

Any obligation for which the "insured" or the "insured's" insurer may be held liable under any workers' compensation, disability benefits or unemployment compensation law or any similar law.

4. Employee Indemnification And Employer's Liability

"Bodily injury" to:

- a. An "employee" of the "insured" arising out of and in the course of:
 - (1) Employment by the "insured"; or
 - (2) Performing the duties related to the conduct of the "insured's" business; or
- b. The spouse, child, parent, brother or sister of that "employee" as a consequence of Paragraph a. above.

This exclusion applies:

- (1) Whether the "insured" may be liable as an employer or in any other capacity; and
- (2) To any obligation to share damages with or repay someone else who must pay damages because of the injury.

But this exclusion does not apply to "bodily injury" to domestic "employees" not entitled to workers' compensation benefits or to liability assumed by the "insured" under an "insured contract". For the purposes of the Coverage Form, a domestic "employee" is a person engaged in household or domestic work performed principally in connection with a residence premises.

5. Fellow Employee

"Bodily injury" to:

- a. Any fellow "employee" of the "insured" arising out of and in the course of the fellow "employee's" employment or while performing duties related to the conduct of your business; or
- b. The spouse, child, parent, brother or sister of that fellow "employee" as a consequence of Paragraph a. above.

6. Care, Custody Or Control

"Property damage" to or "covered pollution cost or expense" involving property owned or transported by the "insured" or in the "insured's" care, custody or control. But this exclusion does not apply to liability assumed under a sidetrack agreement.

7. Handling Of Property

"Bodily injury" or "property damage" resulting from the handling of property:

- a. Before it is moved from the place where it is accepted by the "insured" for movement into or onto the covered "auto"; or

- b. After it is moved from the covered "auto" to the place where it is finally delivered by the "insured".

8. Movement Of Property By Mechanical Device

"Bodily injury" or "property damage" resulting from the movement of property by a mechanical device (other than a hand truck) unless the device is attached to the covered "auto".

9. Operations

"Bodily injury" or "property damage" arising out of the operation of:

- a. Any equipment listed in Paragraphs 6.b. and 6.c. of the definition of "mobile equipment"; or
- b. Machinery or equipment that is on, attached to or part of a land vehicle that would qualify under the definition of "mobile equipment" if it were not subject to a compulsory or financial responsibility law or other motor vehicle insurance law where it is licensed or principally garaged.

10. Completed Operations

"Bodily injury" or "property damage" arising out of your work after that work has been completed or abandoned.

In this exclusion, your work means:

- a. Work or operations performed by you or on your behalf; and
- b. Materials, parts or equipment furnished in connection with such work or operations.

Your work includes warranties or representations made at any time with respect to the fitness, quality, durability or performance of any of the items included in Paragraph a. or b. above.

Your work will be deemed completed at the earliest of the following times:

- (1) When all of the work called for in your contract has been completed;
- (2) When all of the work to be done at the site has been completed if your contract calls for work at more than one site; or
- (3) When that part of the work done at a job site has been put to its intended use by any person or organization other than another contractor or subcontractor working on the same project.

Work that may need service, maintenance, correction, repair or replacement, but which is otherwise complete, will be treated as completed.

11. Pollution

"Bodily injury" or "property damage" arising out of the actual, alleged or threatened discharge, dispersal, seepage, migration, release or escape of "pollutants":

- a. That are, or that are contained in any property that is:
 - (1) Being transported or towed by, handled or handled for movement into, onto or from the covered "auto";
 - (2) Otherwise in the course of transit by or on behalf of the "insured"; or
 - (3) Being stored, disposed of, treated or processed in or upon the covered "auto";
- b. Before the "pollutants" or any property in which the "pollutants" are contained are moved from the place where they are accepted by the "insured" for movement into or onto the covered "auto"; or
- c. After the "pollutants" or any property in which the "pollutants" are contained are moved from the covered "auto" to the place where they are finally delivered, disposed of or abandoned by the "insured".

Paragraph a. above does not apply to fuels, lubricants, fluids, exhaust gases or other similar "pollutants" that are needed for or result from the normal electrical, hydraulic or mechanical functioning of the covered "auto" or its parts if:

- (1) The "pollutants" escape, seep, migrate or are discharged, dispersed or released directly from an "auto" part designed by its manufacturer to hold, store, receive or dispose of such "pollutants"; and
- (2) The "bodily injury", "property damage" or "covered pollution cost or expense" does not arise out of the operation of any equipment listed in Paragraphs 6.b. and 6.c. of the definition of "mobile equipment".

Paragraphs b. and c. above of this exclusion do not apply to "accidents" that occur away from premises owned by or rented to an "insured" with respect to "pollutants" not in or upon a covered "auto" if:

- (a) The "pollutants" or any property in which the "pollutants" are contained are upset, overturned or damaged as a result of the maintenance or use of a covered "auto"; and
- (b) The discharge, dispersal, seepage, migration, release or escape of the "pollutants" is caused directly by such upset, overturn or damage.

12. War

"Bodily injury" or "property damage" arising directly or indirectly out of:

- a. War, including undeclared or civil war;
- b. Warlike action by a military force, including action in hindering or defending against an actual or expected attack, by any government, sovereign or other authority using military personnel or other agents; or
- c. Insurrection, rebellion, revolution, usurped power or action taken by governmental authority in hindering or defending against any of these.

13. Racing

Covered "autos" while used in any professional or organized racing or demolition contest or stunting activity, or while practicing for such contest or activity. This insurance also does not apply while that covered "auto" is being prepared for such a contest or activity.

C. Limit Of Insurance

Regardless of the number of covered "autos", "insureds", premiums paid, claims made or vehicles involved in the "accident", the most we will pay for the total of all damages and "covered pollution cost or expense" combined resulting from any one "accident" is the Limit Of Insurance for Covered Autos Liability Coverage shown in the Declarations.

All "bodily injury", "property damage" and "covered pollution cost or expense" resulting from continuous or repeated exposure to substantially the same conditions will be considered as resulting from one "accident".

No one will be entitled to receive duplicate payments for the same elements of "loss" under this Coverage Form and any Medical Payments Coverage endorsement, Uninsured Motorists Coverage endorsement or Underinsured Motorists Coverage endorsement attached to this Coverage Part.

SECTION III – PHYSICAL DAMAGE COVERAGE

A. Coverage

1. We will pay for "loss" to a covered "auto" or its equipment under:

a. Comprehensive Coverage

From any cause except:

- (1) The covered "auto's" collision with another object; or
- (2) The covered "auto's" overturn.

b. Specified Causes Of Loss Coverage

Caused by:

- (1) Fire, lightning or explosion;
- (2) Theft;
- (3) Windstorm, hail or earthquake;
- (4) Flood;
- (5) Mischief or vandalism; or
- (6) The sinking, burning, collision or derailment of any conveyance transporting the covered "auto".

c. Collision Coverage

Caused by:

- (1) The covered "auto's" collision with another object; or
- (2) The covered "auto's" overturn.

2. Towing

We will pay up to the limit shown in the Declarations for towing and labor costs incurred each time a covered "auto" of the private passenger type is disabled. However, the labor must be performed at the place of disablement.

3. Glass Breakage – Hitting A Bird Or Animal – Falling Objects Or Missiles

If you carry Comprehensive Coverage for the damaged covered "auto", we will pay for the following under Comprehensive Coverage:

- a. Glass breakage;
- b. "Loss" caused by hitting a bird or animal; and
- c. "Loss" caused by falling objects or missiles.

However, you have the option of having glass breakage caused by a covered "auto's" collision or overturn considered a "loss" under Collision Coverage.

4. Coverage Extensions

a. Transportation Expenses

We will pay up to \$20 per day, to a maximum of \$600, for temporary transportation expense incurred by you because of the total theft of a covered "auto" of the private passenger type. We will pay only for those covered "autos" for which you carry either Comprehensive or Specified Causes Of Loss Coverage. We will pay for temporary transportation expenses incurred during the period beginning 48 hours after the theft and ending, regardless of the policy's expiration, when the covered "auto" is returned to use or we pay for its "loss".

b. Loss Of Use Expenses

For Hired Auto Physical Damage, we will pay expenses for which an "insured" becomes legally responsible to pay for loss of use of a vehicle rented or hired without a driver under a written rental contract or agreement. We will pay for loss of use expenses if caused by:

- (1) Other than collision only if the Declarations indicates that Comprehensive Coverage is provided for any covered "auto";
- (2) Specified Causes Of Loss only if the Declarations indicates that Specified Causes Of Loss Coverage is provided for any covered "auto"; or

- (3) Collision only if the Declarations indicates that Collision Coverage is provided for any covered "auto".

However, the most we will pay for any expenses for loss of use is \$20 per day, to a maximum of \$600.

B. Exclusions

- 1. We will not pay for "loss" caused by or resulting from any of the following. Such "loss" is excluded regardless of any other cause or event that contributes concurrently or in any sequence to the "loss".

- a. **Nuclear Hazard**

- (1) The explosion of any weapon employing atomic fission or fusion; or
 - (2) Nuclear reaction or radiation, or radioactive contamination, however caused.

- b. **War Or Military Action**

- (1) War, including undeclared or civil war;
 - (2) Warlike action by a military force, including action in hindering or defending against an actual or expected attack, by any government, sovereign or other authority using military personnel or other agents; or
 - (3) Insurrection, rebellion, revolution, usurped power or action taken by governmental authority in hindering or defending against any of these.

- 2. We will not pay for "loss" to any covered "auto" while used in any professional or organized racing or demolition contest or stunting activity, or while practicing for such contest or activity. We will also not pay for "loss" to any covered "auto" while that covered "auto" is being prepared for such a contest or activity.

- 3. We will not pay for "loss" due and confined to:

- a. Wear and tear, freezing, mechanical or electrical breakdown.
 - b. Blowouts, punctures or other road damage to tires.

This exclusion does not apply to such "loss" resulting from the total theft of a covered "auto".

- 4. We will not pay for "loss" to any of the following:

- a. Tapes, records, discs or other similar audio, visual or data electronic devices designed for use with audio, visual or data electronic equipment.

- b. Any device designed or used to detect speed-measuring equipment, such as radar or laser detectors, and any jamming apparatus intended to elude or disrupt speed-measuring equipment.

- c. Any electronic equipment, without regard to whether this equipment is permanently installed, that reproduces, receives or transmits audio, visual or data signals.

- d. Any accessories used with the electronic equipment described in Paragraph c. above.

- 5. Exclusions 4.c. and 4.d. do not apply to equipment designed to be operated solely by use of the power from the "auto's" electrical system that, at the time of "loss", is:

- a. Permanently installed in or upon the covered "auto";
 - b. Removable from a housing unit which is permanently installed in or upon the covered "auto";
 - c. An integral part of the same unit housing any electronic equipment described in Paragraphs a. and b. above; or
 - d. Necessary for the normal operation of the covered "auto" or the monitoring of the covered "auto's" operating system.

- 6. We will not pay for "loss" to a covered "auto" due to "diminution in value".

C. Limits Of Insurance

- 1. The most we will pay for:

- a. "Loss" to any one covered "auto" is the lesser of:

- (1) The actual cash value of the damaged or stolen property as of the time of the "loss", or
 - (2) The cost of repairing or replacing the damaged or stolen property with other property of like kind and quality.

- b. All electronic equipment that reproduces, receives or transmits audio, visual or data signals in any one "loss" is \$1,000, if, at the time of "loss", such electronic equipment is:

- (1) Permanently installed in or upon the covered "auto" in a housing, opening or other location that is not normally used by the "auto" manufacturer for the installation of such equipment;

- (2) Removable from a permanently installed housing unit as described in Paragraph **b.(1)** above; or
 - (3) An integral part of such equipment as described in Paragraphs **b.(1)** and **b.(2)** above.
2. An adjustment for depreciation and physical condition will be made in determining actual cash value in the event of a total "loss".
 3. If a repair or replacement results in better than like kind or quality, we will not pay for the amount of the betterment.

D. Deductible

For each covered "auto", our obligation to pay for, repair, return or replace damaged or stolen property will be reduced by the applicable deductible shown in the Declarations. Any Comprehensive Coverage deductible shown in the Declarations does not apply to "loss" caused by fire or lightning.

SECTION IV – BUSINESS AUTO CONDITIONS

The following conditions apply in addition to the Common Policy Conditions:

A. Loss Conditions

1. Appraisal For Physical Damage Loss

If you and we disagree on the amount of "loss", either may demand an appraisal of the "loss". In this event, each party will select a competent appraiser. The two appraisers will select a competent and impartial umpire. The appraisers will state separately the actual cash value and amount of "loss". If they fail to agree, they will submit their differences to the umpire. A decision agreed to by any two will be binding. Each party will:

- a. Pay its chosen appraiser; and
- b. Bear the other expenses of the appraisal and umpire equally.

If we submit to an appraisal, we will still retain our right to deny the claim.

2. Duties In The Event Of Accident, Claim, Suit Or Loss

We have no duty to provide coverage under this policy unless there has been full compliance with the following duties:

- a. In the event of "accident", claim, "suit" or "loss", you must give us or our authorized representative prompt notice of the "accident" or "loss". Include:
 - (1) How, when and where the "accident" or "loss" occurred;

- (2) The "insured's" name and address; and
 - (3) To the extent possible, the names and addresses of any injured persons and witnesses.
- b. Additionally, you and any other involved "insured" must:
 - (1) Assume no obligation, make no payment or incur no expense without our consent, except at the "insured's" own cost.
 - (2) Immediately send us copies of any request, demand, order, notice, summons or legal paper received concerning the claim or "suit".
 - (3) Cooperate with us in the investigation or settlement of the claim or defense against the "suit".
 - (4) Authorize us to obtain medical records or other pertinent information.
 - (5) Submit to examination, at our expense, by physicians of our choice, as often as we reasonably require.
 - c. If there is "loss" to a covered "auto" or its equipment, you must also do the following:
 - (1) Promptly notify the police if the covered "auto" or any of its equipment is stolen.
 - (2) Take all reasonable steps to protect the covered "auto" from further damage. Also keep a record of your expenses for consideration in the settlement of the claim.
 - (3) Permit us to inspect the covered "auto" and records proving the "loss" before its repair or disposition.
 - (4) Agree to examinations under oath at our request and give us a signed statement of your answers.

3. Legal Action Against Us

No one may bring a legal action against us under this Coverage Form until:

- a. There has been full compliance with all the terms of this Coverage Form; and
- b. Under Covered Autos Liability Coverage, we agree in writing that the "insured" has an obligation to pay or until the amount of that obligation has finally been determined by judgment after trial. No one has the right under this policy to bring us into an action to determine the "insured's" liability.

4. Loss Payment – Physical Damage Coverages

At our option, we may:

- a. Pay for, repair or replace damaged or stolen property;
- b. Return the stolen property, at our expense. We will pay for any damage that results to the "auto" from the theft; or
- c. Take all or any part of the damaged or stolen property at an agreed or appraised value.

If we pay for the "loss", our payment will include the applicable sales tax for the damaged or stolen property.

5. Transfer Of Rights Of Recovery Against Others To Us

If any person or organization to or for whom we make payment under this Coverage Form has rights to recover damages from another, those rights are transferred to us. That person or organization must do everything necessary to secure our rights and must do nothing after "accident" or "loss" to impair them.

B. General Conditions

1. Bankruptcy

Bankruptcy or insolvency of the "insured" or the "insured's" estate will not relieve us of any obligations under this Coverage Form.

2. Concealment, Misrepresentation Or Fraud

This Coverage Form is void in any case of fraud by you at any time as it relates to this Coverage Form. It is also void if you or any other "insured", at any time, intentionally conceals or misrepresents a material fact concerning:

- a. This Coverage Form;
- b. The covered "auto";
- c. Your interest in the covered "auto"; or
- d. A claim under this Coverage Form.

3. Liberalization

If we revise this Coverage Form to provide more coverage without additional premium charge, your policy will automatically provide the additional coverage as of the day the revision is effective in your state.

4. No Benefit To Bailee – Physical Damage Coverages

We will not recognize any assignment or grant any coverage for the benefit of any person or organization holding, storing or transporting property for a fee regardless of any other provision of this Coverage Form.

5. Other Insurance

a. For any covered "auto" you own, this Coverage Form provides primary insurance. For any covered "auto" you don't own, the insurance provided by this Coverage Form is excess over any other collectible insurance. However, while a covered "auto" which is a "trailer" is connected to another vehicle, the Covered Autos Liability Coverage this Coverage Form provides for the "trailer" is:

- (1) Excess while it is connected to a motor vehicle you do not own; or
- (2) Primary while it is connected to a covered "auto" you own.

b. For Hired Auto Physical Damage Coverage, any covered "auto" you lease, hire, rent or borrow is deemed to be a covered "auto" you own. However, any "auto" that is leased, hired, rented or borrowed with a driver is not a covered "auto".

c. Regardless of the provisions of Paragraph a. above, this Coverage Form's Covered Autos Liability Coverage is primary for any liability assumed under an "insured contract".

d. When this Coverage Form and any other Coverage Form or policy covers on the same basis, either excess or primary, we will pay only our share. Our share is the proportion that the Limit of Insurance of our Coverage Form bears to the total of the limits of all the Coverage Forms and policies covering on the same basis.

6. Premium Audit

- a. The estimated premium for this Coverage Form is based on the exposures you told us you would have when this policy began. We will compute the final premium due when we determine your actual exposures. The estimated total premium will be credited against the final premium due and the first Named Insured will be billed for the balance, if any. The due date for the final premium or retrospective premium is the date shown as the due date on the bill. If the estimated total premium exceeds the final premium due, the first Named Insured will get a refund.
- b. If this policy is issued for more than one year, the premium for this Coverage Form will be computed annually based on our rates or premiums in effect at the beginning of each year of the policy.

7. Policy Period, Coverage Territory

Under this Coverage Form, we cover "accidents" and "losses" occurring:

- a. During the policy period shown in the Declarations; and
- b. Within the coverage territory.

The coverage territory is:

- (1) The United States of America;
- (2) The territories and possessions of the United States of America;
- (3) Puerto Rico;
- (4) Canada; and
- (5) Anywhere in the world if a covered "auto" of the private passenger type is leased, hired, rented or borrowed without a driver for a period of 30 days or less.

provided that the "insured's" responsibility to pay damages is determined in a "suit" on the merits, in the United States of America, the territories and possessions of the United States of America, Puerto Rico or Canada, or in a settlement we agree to.

We also cover "loss" to, or "accidents" involving, a covered "auto" while being transported between any of these places.

8. Two Or More Coverage Forms Or Policies Issued By Us

If this Coverage Form and any other Coverage Form or policy issued to you by us or any company affiliated with us applies to the same "accident", the aggregate maximum Limit of Insurance under all the Coverage Forms or policies shall not exceed the highest applicable Limit of Insurance under any one Coverage Form or policy. This condition does not apply to any Coverage Form or policy issued by us or an affiliated company specifically to apply as excess insurance over this Coverage Form.

SECTION V – DEFINITIONS

- A. "Accident" includes continuous or repeated exposure to the same conditions resulting in "bodily injury" or "property damage".
- B. "Auto" means:
 1. A land motor vehicle, "trailer" or semitrailer designed for travel on public roads; or
 2. Any other land vehicle that is subject to a compulsory or financial responsibility law or other motor vehicle insurance law where it is licensed or principally garaged.

However, "auto" does not include "mobile equipment".

- C. "Bodily injury" means bodily injury, sickness or disease sustained by a person, including death resulting from any of these.
- D. "Covered pollution cost or expense" means any cost or expense arising out of:
 1. Any request, demand, order or statutory or regulatory requirement that any "insured" or others test for, monitor, clean up, remove, contain, treat, detoxify or neutralize, or in any way respond to, or assess the effects of, "pollutants"; or
 2. Any claim or "suit" by or on behalf of a governmental authority for damages because of testing for, monitoring, cleaning up, removing, containing, treating, detoxifying or neutralizing, or in any way responding to, or assessing the effects of, "pollutants".

"Covered pollution cost or expense" does not include any cost or expense arising out of the actual, alleged or threatened discharge, dispersal, seepage, migration, release or escape of "pollutants":

- a. That are, or that are contained in any property that is:

- (1) Being transported or towed by, handled or handled for movement into, onto or from the covered "auto";
 - (2) Otherwise in the course of transit by or on behalf of the "insured"; or
 - (3) Being stored, disposed of, treated or processed in or upon the covered "auto";
- b. Before the "pollutants" or any property in which the "pollutants" are contained are moved from the place where they are accepted by the "insured" for movement into or onto the covered "auto"; or
 - c. After the "pollutants" or any property in which the "pollutants" are contained are moved from the covered "auto" to the place where they are finally delivered, disposed of or abandoned by the "insured".

Paragraph a. above does not apply to fuels, lubricants, fluids, exhaust gases or other similar "pollutants" that are needed for or result from the normal electrical, hydraulic or mechanical functioning of the covered "auto" or its parts, if:

- (1) The "pollutants" escape, seep, migrate or are discharged, dispersed or released directly from an "auto" part designed by its manufacturer to hold, store, receive or dispose of such "pollutants"; and
- (2) The "bodily injury", "property damage" or "covered pollution cost or expense" does not arise out of the operation of any equipment listed in Paragraph 6.b. or 6.c. of the definition of "mobile equipment".

Paragraphs b. and c. above do not apply to "accidents" that occur away from premises owned by or rented to an "insured" with respect to "pollutants" not in or upon a covered "auto" if:

- (a) The "pollutants" or any property in which the "pollutants" are contained are upset, overturned or damaged as a result of the maintenance or use of a covered "auto"; and
- (b) The discharge, dispersal, seepage, migration, release or escape of the "pollutants" is caused directly by such upset, overturn or damage.

E. "Diminution in value" means the actual or perceived loss in market value or resale value which results from a direct and accidental "loss".

F. "Employee" includes a "leased worker". "Employee" does not include a "temporary worker".

G. "Insured" means any person or organization qualifying as an insured in the Who Is An Insured provision of the applicable coverage. Except with respect to the Limit of Insurance, the coverage afforded applies separately to each insured who is seeking coverage or against whom a claim or "suit" is brought.

H. "Insured contract" means:

- 1. A lease of premises;
- 2. A sidetrack agreement;
- 3. Any easement or license agreement, except in connection with construction or demolition operations on or within 50 feet of a railroad;
- 4. An obligation, as required by ordinance, to indemnify a municipality, except in connection with work for a municipality;
- 5. That part of any other contract or agreement pertaining to your business (including an indemnification of a municipality in connection with work performed for a municipality) under which you assume the tort liability of another to pay for "bodily injury" or "property damage" to a third party or organization. Tort liability means a liability that would be imposed by law in the absence of any contract or agreement; or
- 6. That part of any contract or agreement entered into, as part of your business, pertaining to the rental or lease, by you or any of your "employees", of any "auto". However, such contract or agreement shall not be considered an "insured contract" to the extent that it obligates you or any of your "employees" to pay for "property damage" to any "auto" rented or leased by you or any of your "employees".

An "insured contract" does not include that part of any contract or agreement:

- a. That indemnifies a railroad for "bodily injury" or "property damage" arising out of construction or demolition operations, within 50 feet of any railroad property and affecting any railroad bridge or trestle, tracks, roadbeds, tunnel, underpass or crossing;
- b. That pertains to the loan, lease or rental of an "auto" to you or any of your "employees", if the "auto" is loaned, leased or rented with a driver; or

- c. That holds a person or organization engaged in the business of transporting property by "auto" for hire harmless for your use of a covered "auto" over a route or territory that person or organization is authorized to serve by public authority.
- I. "Leased worker" means a person leased to you by a labor leasing firm under an agreement between you and the labor leasing firm to perform duties related to the conduct of your business. "Leased worker" does not include a "temporary worker".
- J. "Loss" means direct and accidental loss or damage.
- K. "Mobile equipment" means any of the following types of land vehicles, including any attached machinery or equipment:
 1. Bulldozers, farm machinery, forklifts and other vehicles designed for use principally off public roads;
 2. Vehicles maintained for use solely on or next to premises you own or rent;
 3. Vehicles that travel on crawler treads;
 4. Vehicles, whether self-propelled or not, maintained primarily to provide mobility to permanently mounted:
 - a. Power cranes, shovels, loaders, diggers or drills; or
 - b. Road construction or resurfacing equipment such as graders, scrapers or rollers;
 5. Vehicles not described in Paragraph 1., 2., 3. or 4. above that are not self-propelled and are maintained primarily to provide mobility to permanently attached equipment of the following types:
 - a. Air compressors, pumps and generators, including spraying, welding, building cleaning, geophysical exploration, lighting and well-servicing equipment; or
 - b. Cherry pickers and similar devices used to raise or lower workers; or
 6. Vehicles not described in Paragraph 1., 2., 3. or 4. above maintained primarily for purposes other than the transportation of persons or cargo. However, self-propelled vehicles with the following types of permanently attached equipment are not "mobile equipment" but will be considered "autos":
 - a. Equipment designed primarily for:
 - (1) Snow removal;
 - (2) Road maintenance, but not construction or resurfacing; or
 - (3) Street cleaning;
 - b. Cherry pickers and similar devices mounted on automobile or truck chassis and used to raise or lower workers; and
 - c. Air compressors, pumps and generators, including spraying, welding, building cleaning, geophysical exploration, lighting or well-servicing equipment.

However, "mobile equipment" does not include land vehicles that are subject to a compulsory or financial responsibility law or other motor vehicle insurance law where it is licensed or principally garaged. Land vehicles subject to a compulsory or financial responsibility law or other motor vehicle insurance law are considered "autos".
- L. "Pollutants" means any solid, liquid, gaseous or thermal irritant or contaminant, including smoke, vapor, soot, fumes, acids, alkalis, chemicals and waste. Waste includes materials to be recycled, reconditioned or reclaimed.
- M. "Property damage" means damage to or loss of use of tangible property.
- N. "Suit" means a civil proceeding in which:
 1. Damages because of "bodily injury" or "property damage"; or
 2. A "covered pollution cost or expense";
 to which this insurance applies, are alleged. "Suit" includes:
 - a. An arbitration proceeding in which such damages or "covered pollution costs or expenses" are claimed and to which the "insured" must submit or does submit with our consent; or
 - b. Any other alternative dispute resolution proceeding in which such damages or "covered pollution costs or expenses" are claimed and to which the insured submits with our consent.
- O. "Temporary worker" means a person who is furnished to you to substitute for a permanent "employee" on leave or to meet seasonal or short-term workload conditions.
- P. "Trailer" includes semitrailer.

THIS ENDORSEMENT CHANGES THE POLICY. PLEASE READ IT CAREFULLY.

**POLLUTION LIABILITY – BROADENED COVERAGE
FOR COVERED AUTOS – BUSINESS AUTO AND
MOTOR CARRIER COVERAGE FORMS**

This endorsement modifies insurance provided under the following:

BUSINESS AUTO COVERAGE FORM
MOTOR CARRIER COVERAGE FORM

With respect to coverage provided by this endorsement, the provisions of the Coverage Form apply unless modified by the endorsement.

A. Covered Autos Liability Coverage is changed as follows:

1. Paragraph **a.** of the **Pollution Exclusion** applies only to liability assumed under a contract or agreement.
2. With respect to the coverage afforded by Paragraph **A.1.** above, Exclusion **B.6. Care, Custody Or Control** does not apply.

B. Changes In Definitions

For the purposes of this endorsement, Paragraph **D.** of the **Definitions** Section is replaced by the following:

D. "Covered pollution cost or expense" means any cost or expense arising out of:

1. Any request, demand, order or statutory or regulatory requirement that any "insured" or others test for, monitor, clean up, remove, contain, treat, detoxify or neutralize, or in any way respond to, or assess the effects of "pollutants"; or
2. Any claim or "suit" by or on behalf of a governmental authority for damages because of testing for, monitoring, cleaning up, removing, containing, treating, detoxifying or neutralizing, or in any way responding to or assessing the effects of "pollutants".

"Covered pollution cost or expense" does not include any cost or expense arising out of the actual, alleged or threatened discharge, dispersal, seepage, migration, release or escape of "pollutants":

- a. Before the "pollutants" or any property in which the "pollutants" are contained are moved from the place where they are accepted by the "insured" for movement into or onto the covered "auto"; or
- b. After the "pollutants" or any property in which the "pollutants" are contained are moved from the covered "auto" to the place where they are finally delivered, disposed of or abandoned by the "insured".

Paragraphs **a.** and **b.** above do not apply to "accidents" that occur away from premises owned by or rented to an "insured" with respect to "pollutants" not in or upon a covered "auto" if:

- (1) The "pollutants" or any property in which the "pollutants" are contained are upset, overturned or damaged as a result of the maintenance or use of a covered "auto"; and
- (2) The discharge, dispersal, seepage, migration, release or escape of the "pollutants" is caused directly by such upset, overturn or damage.

BUSINESS AUTO COVERAGE FORM

Various provisions in this policy restrict coverage. Read the entire policy carefully to determine rights, duties and what is and is not covered.

Throughout this policy the words "you" and "your" refer to the Named Insured shown in the Declarations. The words "we", "us" and "our" refer to the company providing this insurance.

Other words and phrases that appear in quotation marks have special meaning. Refer to Section V – Definitions.

SECTION I – COVERED AUTOS

Item Two of the Declarations shows the "autos" that are covered "autos" for each of your coverages. The following numerical symbols describe the "autos" that may be covered "autos". The symbols entered next to a coverage on the Declarations designate the only "autos" that are covered "autos".

A. Description Of Covered Auto Designation Symbols

Symbol	Description Of Covered Auto Designation Symbols
1	Any "Auto"
2	Owned "Autos" Only Only those "autos" you own (and for Covered Autos Liability Coverage any "trailers" you don't own while attached to power units you own). This includes those "autos" you acquire ownership of after the policy begins.
3	Owned Private Passenger "Autos" Only Only the private passenger "autos" you own. This includes those private passenger "autos" you acquire ownership of after the policy begins.
4	Owned "Autos" Other Than Private Passenger "Autos" Only Only those "autos" you own that are not of the private passenger type (and for Covered Autos Liability Coverage any "trailers" you don't own while attached to power units you own). This includes those "autos" not of the private passenger type you acquire ownership of after the policy begins.
5	Owned "Autos" Subject To No-fault Only those "autos" you own that are required to have no-fault benefits in the state where they are licensed or principally garaged. This includes those "autos" you acquire ownership of after the policy begins provided they are required to have no-fault benefits in the state where they are licensed or principally garaged.
6	Owned "Autos" Subject To A Compulsory Uninsured Motorists Law Only those "autos" you own that because of the law in the state where they are licensed or principally garaged are required to have and cannot reject Uninsured Motorists Coverage. This includes those "autos" you acquire ownership of after the policy begins provided they are subject to the same state uninsured motorists requirement.
7	Specifically Described "Autos" Only those "autos" described in Item Three of the Declarations for which a premium charge is shown (and for Covered Autos Liability Coverage any "trailers" you don't own while attached to any power unit described in Item Three).
8	Hired "Autos" Only Only those "autos" you lease, hire, rent or borrow. This does not include any "auto" you lease, hire, rent or borrow from any of your "employees", partners (if you are a partnership), members (if you are a limited liability company) or members of their households.
9	Non-owned "Autos" Only Only those "autos" you do not own, lease, hire, rent or borrow that are used in connection with your business. This includes "autos" owned by your "employees", partners (if you are a partnership), members (if you are a limited liability company) or members of their households but only while used in your business or your personal affairs.

19	Mobile Equipment Subject To Compulsory Or Financial Responsibility Or Other Motor Vehicle Insurance Law Only	Only those "autos" that are land vehicles and that would qualify under the definition of "mobile equipment" under this policy if they were not subject to a compulsory or financial responsibility law or other motor vehicle insurance law where they are licensed or principally garaged.
----	--	---

B. Owned Autos You Acquire After The Policy Begins

1. If Symbols 1, 2, 3, 4, 5, 6 or 19 are entered next to a coverage in Item Two of the Declarations, then you have coverage for "autos" that you acquire of the type described for the remainder of the policy period.
2. But, if Symbol 7 is entered next to a coverage in Item Two of the Declarations, an "auto" you acquire will be a covered "auto" for that coverage only if:
 - a. We already cover all "autos" that you own for that coverage or it replaces an "auto" you previously owned that had that coverage; and
 - b. You tell us within 30 days after you acquire it that you want us to cover it for that coverage.

C. Certain Trailers, Mobile Equipment And Temporary Substitute Autos

If Covered Autos Liability Coverage is provided by this Coverage Form, the following types of vehicles are also covered "autos" for Covered Autos Liability Coverage:

1. "Trailers" with a load capacity of 2,000 pounds or less designed primarily for travel on public roads.
2. "Mobile equipment" while being carried or towed by a covered "auto".
3. Any "auto" you do not own while used with the permission of its owner as a temporary substitute for a covered "auto" you own that is out of service because of its:
 - a. Breakdown;
 - b. Repair;
 - c. Servicing;
 - d. "Loss"; or
 - e. Destruction.

SECTION II – COVERED AUTOS LIABILITY COVERAGE

A. Coverage

We will pay all sums an "insured" legally must pay as damages because of "bodily injury" or "property damage" to which this insurance applies, caused by an "accident" and resulting from the ownership, maintenance or use of a covered "auto".

We will also pay all sums an "insured" legally must pay as a "covered pollution cost or expense" to which this insurance applies, caused by an "accident" and resulting from the ownership, maintenance or use of covered "autos". However, we will only pay for the "covered pollution cost or expense" if there is either "bodily injury" or "property damage" to which this insurance applies that is caused by the same "accident".

We have the right and duty to defend any "insured" against a "suit" asking for such damages or a "covered pollution cost or expense". However, we have no duty to defend any "insured" against a "suit" seeking damages for "bodily injury" or "property damage" or a "covered pollution cost or expense" to which this insurance does not apply. We may investigate and settle any claim or "suit" as we consider appropriate. Our duty to defend or settle ends when the Covered Autos Liability Coverage Limit of Insurance has been exhausted by payment of judgments or settlements.

1. Who Is An Insured

The following are "insureds":

- a. You for any covered "auto".
- b. Anyone else while using with your permission a covered "auto" you own, hire or borrow except:
 - (1) The owner or anyone else from whom you hire or borrow a covered "auto".
This exception does not apply if the covered "auto" is a "trailer" connected to a covered "auto" you own.

- (2) Your "employee" if the covered "auto" is owned by that "employee" or a member of his or her household.
 - (3) Someone using a covered "auto" while he or she is working in a business of selling, servicing, repairing, parking or storing "autos" unless that business is yours.
 - (4) Anyone other than your "employees", partners (if you are a partnership), members (if you are a limited liability company) or a lessee or borrower or any of their "employees", while moving property to or from a covered "auto".
 - (5) A partner (if you are a partnership) or a member (if you are a limited liability company) for a covered "auto" owned by him or her or a member of his or her household.
- c. Anyone liable for the conduct of an "insured" described above but only to the extent of that liability.

2. Coverage Extensions

a. Supplementary Payments

We will pay for the "insured":

- (1) All expenses we incur.
- (2) Up to \$2,000 for cost of bail bonds (including bonds for related traffic law violations) required because of an "accident" we cover. We do not have to furnish these bonds.
- (3) The cost of bonds to release attachments in any "suit" against the "insured" we defend, but only for bond amounts within our Limit of Insurance.
- (4) All reasonable expenses incurred by the "insured" at our request, including actual loss of earnings up to \$250 a day because of time off from work.
- (5) All court costs taxed against the "insured" in any "suit" against the "insured" we defend. However, these payments do not include attorneys' fees or attorneys' expenses taxed against the "insured".
- (6) All interest on the full amount of any judgment that accrues after entry of the judgment in any "suit" against the "insured" we defend, but our duty to pay interest ends when we have paid, offered to pay or deposited in court the

part of the judgment that is within our Limit of Insurance.

These payments will not reduce the Limit of Insurance.

b. Out-of-state Coverage Extensions

While a covered "auto" is away from the state where it is licensed, we will:

- (1) Increase the Limit of Insurance for Covered Autos Liability Coverage to meet the limits specified by a compulsory or financial responsibility law of the jurisdiction where the covered "auto" is being used. This extension does not apply to the limit or limits specified by any law governing motor carriers of passengers or property.
- (2) Provide the minimum amounts and types of other coverages, such as no-fault, required of out-of-state vehicles by the jurisdiction where the covered "auto" is being used.

We will not pay anyone more than once for the same elements of loss because of these extensions.

B. Exclusions

This insurance does not apply to any of the following:

1. Expected Or Intended Injury

"Bodily injury" or "property damage" expected or intended from the standpoint of the "insured".

2. Contractual

Liability assumed under any contract or agreement.

But this exclusion does not apply to liability for damages:

- a. Assumed in a contract or agreement that is an "insured contract", provided the "bodily injury" or "property damage" occurs subsequent to the execution of the contract or agreement; or
- b. That the "insured" would have in the absence of the contract or agreement.

3. Workers' Compensation

Any obligation for which the "insured" or the "insured's" insurer may be held liable under any workers' compensation, disability benefits or unemployment compensation law or any similar law.

4. Employee Indemnification And Employer's Liability

"Bodily injury" to:

- a. An "employee" of the "insured" arising out of and in the course of:
 - (1) Employment by the "insured"; or
 - (2) Performing the duties related to the conduct of the "insured's" business; or

- b. The spouse, child, parent, brother or sister of that "employee" as a consequence of Paragraph a. above.

This exclusion applies:

- (1) Whether the "insured" may be liable as an employer or in any other capacity; and
- (2) To any obligation to share damages with or repay someone else who must pay damages because of the injury.

But this exclusion does not apply to "bodily injury" to domestic "employees" not entitled to workers' compensation benefits or to liability assumed by the "insured" under an "insured contract". For the purposes of the Coverage Form, a domestic "employee" is a person engaged in household or domestic work performed principally in connection with a residence premises.

5. Fellow Employee

"Bodily injury" to:

- a. Any fellow "employee" of the "insured" arising out of and in the course of the fellow "employee's" employment or while performing duties related to the conduct of your business; or
- b. The spouse, child, parent, brother or sister of that fellow "employee" as a consequence of Paragraph a. above.

6. Care, Custody Or Control

"Property damage" to or "covered pollution cost or expense" involving property owned or transported by the "insured" or in the "insured's" care, custody or control. But this exclusion does not apply to liability assumed under a sidetrack agreement.

7. Handling Of Property

"Bodily injury" or "property damage" resulting from the handling of property:

- a. Before it is moved from the place where it is accepted by the "insured" for movement into or onto the covered "auto"; or

- b. After it is moved from the covered "auto" to the place where it is finally delivered by the "insured".

8. Movement Of Property By Mechanical Device

"Bodily injury" or "property damage" resulting from the movement of property by a mechanical device (other than a hand truck) unless the device is attached to the covered "auto".

9. Operations

"Bodily injury" or "property damage" arising out of the operation of:

- a. Any equipment listed in Paragraphs 6.b. and 6.c. of the definition of "mobile equipment"; or
- b. Machinery or equipment that is on, attached to or part of a land vehicle that would qualify under the definition of "mobile equipment" if it were not subject to a compulsory or financial responsibility law or other motor vehicle insurance law where it is licensed or principally garaged.

10. Completed Operations

"Bodily injury" or "property damage" arising out of your work after that work has been completed or abandoned.

In this exclusion, your work means:

- a. Work or operations performed by you or on your behalf; and
- b. Materials, parts or equipment furnished in connection with such work or operations.

Your work includes warranties or representations made at any time with respect to the fitness, quality, durability or performance of any of the items included in Paragraph a. or b. above.

Your work will be deemed completed at the earliest of the following times:

- (1) When all of the work called for in your contract has been completed;
- (2) When all of the work to be done at the site has been completed if your contract calls for work at more than one site; or
- (3) When that part of the work done at a job site has been put to its intended use by any person or organization other than another contractor or subcontractor working on the same project.

Work that may need service, maintenance, correction, repair or replacement, but which is otherwise complete, will be treated as completed.

11. Pollution

"Bodily injury" or "property damage" arising out of the actual, alleged or threatened discharge, dispersal, seepage, migration, release or escape of "pollutants":

- a. That are, or that are contained in any property that is:
 - (1) Being transported or towed by, handled or handled for movement into, onto or from the covered "auto";
 - (2) Otherwise in the course of transit by or on behalf of the "insured"; or
 - (3) Being stored, disposed of, treated or processed in or upon the covered "auto";
- b. Before the "pollutants" or any property in which the "pollutants" are contained are moved from the place where they are accepted by the "insured" for movement into or onto the covered "auto"; or
- c. After the "pollutants" or any property in which the "pollutants" are contained are moved from the covered "auto" to the place where they are finally delivered, disposed of or abandoned by the "insured".

Paragraph a. above does not apply to fuels, lubricants, fluids, exhaust gases or other similar "pollutants" that are needed for or result from the normal electrical, hydraulic or mechanical functioning of the covered "auto" or its parts if:

- (1) The "pollutants" escape, seep, migrate or are discharged, dispersed or released directly from an "auto" part designed by its manufacturer to hold, store, receive or dispose of such "pollutants"; and
- (2) The "bodily injury", "property damage" or "covered pollution cost or expense" does not arise out of the operation of any equipment listed in Paragraphs 6.b. and 6.c. of the definition of "mobile equipment".

Paragraphs b. and c. above of this exclusion do not apply to "accidents" that occur away from premises owned by or rented to an "insured" with respect to "pollutants" not in or upon a covered "auto" if:

- (a) The "pollutants" or any property in which the "pollutants" are contained are upset, overturned or damaged as a result of the maintenance or use of a covered "auto"; and
- (b) The discharge, dispersal, seepage, migration, release or escape of the "pollutants" is caused directly by such upset, overturn or damage.

12. War

"Bodily injury" or "property damage" arising directly or indirectly out of:

- a. War, including undeclared or civil war;
- b. Warlike action by a military force, including action in hindering or defending against an actual or expected attack, by any government, sovereign or other authority using military personnel or other agents; or
- c. Insurrection, rebellion, revolution, usurped power or action taken by governmental authority in hindering or defending against any of these.

13. Racing

Covered "autos" while used in any professional or organized racing or demolition contest or stunting activity, or while practicing for such contest or activity. This insurance also does not apply while that covered "auto" is being prepared for such a contest or activity.

C. Limit Of Insurance

Regardless of the number of covered "autos", "insureds", premiums paid, claims made or vehicles involved in the "accident", the most we will pay for the total of all damages and "covered pollution cost or expense" combined resulting from any one "accident" is the Limit Of Insurance for Covered Autos Liability Coverage shown in the Declarations.

All "bodily injury", "property damage" and "covered pollution cost or expense" resulting from continuous or repeated exposure to substantially the same conditions will be considered as resulting from one "accident".

No one will be entitled to receive duplicate payments for the same elements of "loss" under this Coverage Form and any Medical Payments Coverage endorsement, Uninsured Motorists Coverage endorsement or Underinsured Motorists Coverage endorsement attached to this Coverage Part.

SECTION III – PHYSICAL DAMAGE COVERAGE

A. Coverage

1. We will pay for "loss" to a covered "auto" or its equipment under:

a. Comprehensive Coverage

From any cause except:

- (1) The covered "auto's" collision with another object; or
- (2) The covered "auto's" overturn.

b. Specified Causes Of Loss Coverage

Caused by:

- (1) Fire, lightning or explosion;
- (2) Theft;
- (3) Windstorm, hail or earthquake;
- (4) Flood;
- (5) Mischief or vandalism; or
- (6) The sinking, burning, collision or derailment of any conveyance transporting the covered "auto".

c. Collision Coverage

Caused by:

- (1) The covered "auto's" collision with another object; or
- (2) The covered "auto's" overturn.

2. Towing

We will pay up to the limit shown in the Declarations for towing and labor costs incurred each time a covered "auto" of the private passenger type is disabled. However, the labor must be performed at the place of disablement.

3. Glass Breakage – Hitting A Bird Or Animal – Falling Objects Or Missiles

If you carry Comprehensive Coverage for the damaged covered "auto", we will pay for the following under Comprehensive Coverage:

- a. Glass breakage;
- b. "Loss" caused by hitting a bird or animal; and
- c. "Loss" caused by falling objects or missiles.

However, you have the option of having glass breakage caused by a covered "auto's" collision or overturn considered a "loss" under Collision Coverage.

4. Coverage Extensions

a. Transportation Expenses

We will pay up to \$20 per day, to a maximum of \$600, for temporary transportation expense incurred by you because of the total theft of a covered "auto" of the private passenger type. We will pay only for those covered "autos" for which you carry either Comprehensive or Specified Causes Of Loss Coverage. We will pay for temporary transportation expenses incurred during the period beginning 48 hours after the theft and ending, regardless of the policy's expiration, when the covered "auto" is returned to use or we pay for its "loss".

b. Loss Of Use Expenses

For Hired Auto Physical Damage, we will pay expenses for which an "insured" becomes legally responsible to pay for loss of use of a vehicle rented or hired without a driver under a written rental contract or agreement. We will pay for loss of use expenses if caused by:

- (1) Other than collision only if the Declarations indicates that Comprehensive Coverage is provided for any covered "auto";
- (2) Specified Causes Of Loss only if the Declarations indicates that Specified Causes Of Loss Coverage is provided for any covered "auto"; or

(3) Collision only if the Declarations indicates that Collision Coverage is provided for any covered "auto".

However, the most we will pay for any expenses for loss of use is \$20 per day, to a maximum of \$600.

B. Exclusions

1. We will not pay for "loss" caused by or resulting from any of the following. Such "loss" is excluded regardless of any other cause or event that contributes concurrently or in any sequence to the "loss".

a. Nuclear Hazard

(1) The explosion of any weapon employing atomic fission or fusion; or

(2) Nuclear reaction or radiation, or radioactive contamination, however caused.

b. War Or Military Action

(1) War, including undeclared or civil war;

(2) Warlike action by a military force, including action in hindering or defending against an actual or expected attack, by any government, sovereign or other authority using military personnel or other agents; or

(3) Insurrection, rebellion, revolution, usurped power or action taken by governmental authority in hindering or defending against any of these.

2. We will not pay for "loss" to any covered "auto" while used in any professional or organized racing or demolition contest or stunting activity, or while practicing for such contest or activity. We will also not pay for "loss" to any covered "auto" while that covered "auto" is being prepared for such a contest or activity.

3. We will not pay for "loss" due and confined to:

a. Wear and tear, freezing, mechanical or electrical breakdown.

b. Blowouts, punctures or other road damage to tires.

This exclusion does not apply to such "loss" resulting from the total theft of a covered "auto".

4. We will not pay for "loss" to any of the following:

a. Tapes, records, discs or other similar audio, visual or data electronic devices designed for use with audio, visual or data electronic equipment.

b. Any device designed or used to detect speed-measuring equipment, such as radar or laser detectors, and any jamming apparatus intended to elude or disrupt speed-measuring equipment.

c. Any electronic equipment, without regard to whether this equipment is permanently installed, that reproduces, receives or transmits audio, visual or data signals.

d. Any accessories used with the electronic equipment described in Paragraph c. above.

5. Exclusions 4.c. and 4.d. do not apply to equipment designed to be operated solely by use of the power from the "auto's" electrical system that, at the time of "loss", is:

a. Permanently installed in or upon the covered "auto";

b. Removable from a housing unit which is permanently installed in or upon the covered "auto";

c. An integral part of the same unit housing any electronic equipment described in Paragraphs a. and b. above; or

d. Necessary for the normal operation of the covered "auto" or the monitoring of the covered "auto's" operating system.

6. We will not pay for "loss" to a covered "auto" due to "diminution in value".

C. Limits Of Insurance

1. The most we will pay for:

a. "Loss" to any one covered "auto" is the lesser of:

(1) The actual cash value of the damaged or stolen property as of the time of the "loss"; or

(2) The cost of repairing or replacing the damaged or stolen property with other property of like kind and quality.

b. All electronic equipment that reproduces, receives or transmits audio, visual or data signals in any one "loss" is \$1,000, if, at the time of "loss", such electronic equipment is:

(1) Permanently installed in or upon the covered "auto" in a housing, opening or other location that is not normally used by the "auto" manufacturer for the installation of such equipment;

- (2) Removable from a permanently installed housing unit as described in Paragraph **b.(1)** above; or
 - (3) An integral part of such equipment as described in Paragraphs **b.(1)** and **b.(2)** above.
2. An adjustment for depreciation and physical condition will be made in determining actual cash value in the event of a total "loss".
 3. If a repair or replacement results in better than like kind or quality, we will not pay for the amount of the betterment.

D. Deductible

For each covered "auto", our obligation to pay for, repair, return or replace damaged or stolen property will be reduced by the applicable deductible shown in the Declarations. Any Comprehensive Coverage deductible shown in the Declarations does not apply to "loss" caused by fire or lightning.

SECTION IV – BUSINESS AUTO CONDITIONS

The following conditions apply in addition to the Common Policy Conditions:

A. Loss Conditions

1. Appraisal For Physical Damage Loss

If you and we disagree on the amount of "loss", either may demand an appraisal of the "loss". In this event, each party will select a competent appraiser. The two appraisers will select a competent and impartial umpire. The appraisers will state separately the actual cash value and amount of "loss". If they fail to agree, they will submit their differences to the umpire. A decision agreed to by any two will be binding. Each party will:

- a. Pay its chosen appraiser; and
- b. Bear the other expenses of the appraisal and umpire equally.

If we submit to an appraisal, we will still retain our right to deny the claim.

2. Duties In The Event Of Accident, Claim, Suit Or Loss

We have no duty to provide coverage under this policy unless there has been full compliance with the following duties:

- a. In the event of "accident", claim, "suit" or "loss", you must give us or our authorized representative prompt notice of the "accident" or "loss". Include:
 - (1) How, when and where the "accident" or "loss" occurred;

- (2) The "insured's" name and address; and
- (3) To the extent possible, the names and addresses of any injured persons and witnesses.

b. Additionally, you and any other involved "insured" must:

- (1) Assume no obligation, make no payment or incur no expense without our consent, except at the "insured's" own cost.
- (2) Immediately send us copies of any request, demand, order, notice, summons or legal paper received concerning the claim or "suit".
- (3) Cooperate with us in the investigation or settlement of the claim or defense against the "suit".
- (4) Authorize us to obtain medical records or other pertinent information.
- (5) Submit to examination, at our expense, by physicians of our choice, as often as we reasonably require.

c. If there is "loss" to a covered "auto" or its equipment, you must also do the following:

- (1) Promptly notify the police if the covered "auto" or any of its equipment is stolen.
- (2) Take all reasonable steps to protect the covered "auto" from further damage. Also keep a record of your expenses for consideration in the settlement of the claim.
- (3) Permit us to inspect the covered "auto" and records proving the "loss" before its repair or disposition.
- (4) Agree to examinations under oath at our request and give us a signed statement of your answers.

3. Legal Action Against Us

No one may bring a legal action against us under this Coverage Form until:

- a. There has been full compliance with all the terms of this Coverage Form; and
- b. Under Covered Autos Liability Coverage, we agree in writing that the "insured" has an obligation to pay or until the amount of that obligation has finally been determined by judgment after trial. No one has the right under this policy to bring us into an action to determine the "insured's" liability.

4. Loss Payment – Physical Damage Coverages

At our option, we may:

- a. Pay for, repair or replace damaged or stolen property;
- b. Return the stolen property, at our expense. We will pay for any damage that results to the "auto" from the theft; or
- c. Take all or any part of the damaged or stolen property at an agreed or appraised value.

If we pay for the "loss", our payment will include the applicable sales tax for the damaged or stolen property.

5. Transfer Of Rights Of Recovery Against Others To Us

If any person or organization to or for whom we make payment under this Coverage Form has rights to recover damages from another, those rights are transferred to us. That person or organization must do everything necessary to secure our rights and must do nothing after "accident" or "loss" to impair them.

B. General Conditions

1. Bankruptcy

Bankruptcy or insolvency of the "insured" or the "insured's" estate will not relieve us of any obligations under this Coverage Form.

2. Concealment, Misrepresentation Or Fraud

This Coverage Form is void in any case of fraud by you at any time as it relates to this Coverage Form. It is also void if you or any other "insured", at any time, intentionally conceals or misrepresents a material fact concerning:

- a. This Coverage Form;
- b. The covered "auto";
- c. Your interest in the covered "auto"; or
- d. A claim under this Coverage Form.

3. Liberalization

If we revise this Coverage Form to provide more coverage without additional premium charge, your policy will automatically provide the additional coverage as of the day the revision is effective in your state.

4. No Benefit To Bailee – Physical Damage Coverages

We will not recognize any assignment or grant any coverage for the benefit of any person or organization holding, storing or transporting property for a fee regardless of any other provision of this Coverage Form.

5. Other Insurance

a. For any covered "auto" you own, this Coverage Form provides primary insurance. For any covered "auto" you don't own, the insurance provided by this Coverage Form is excess over any other collectible insurance. However, while a covered "auto" which is a "trailer" is connected to another vehicle, the Covered Autos Liability Coverage this Coverage Form provides for the "trailer" is:

- (1) Excess while it is connected to a motor vehicle you do not own; or
- (2) Primary while it is connected to a covered "auto" you own.

b. For Hired Auto Physical Damage Coverage, any covered "auto" you lease, hire, rent or borrow is deemed to be a covered "auto" you own. However, any "auto" that is leased, hired, rented or borrowed with a driver is not a covered "auto".

c. Regardless of the provisions of Paragraph a. above, this Coverage Form's Covered Autos Liability Coverage is primary for any liability assumed under an "insured contract".

d. When this Coverage Form and any other Coverage Form or policy covers on the same basis, either excess or primary, we will pay only our share. Our share is the proportion that the Limit of Insurance of our Coverage Form bears to the total of the limits of all the Coverage Forms and policies covering on the same basis.

6. Premium Audit

- a. The estimated premium for this Coverage Form is based on the exposures you told us you would have when this policy began. We will compute the final premium due when we determine your actual exposures. The estimated total premium will be credited against the final premium due and the first Named Insured will be billed for the balance, if any. The due date for the final premium or retrospective premium is the date shown as the due date on the bill. If the estimated total premium exceeds the final premium due, the first Named Insured will get a refund.
- b. If this policy is issued for more than one year, the premium for this Coverage Form will be computed annually based on our rates or premiums in effect at the beginning of each year of the policy.

7. Policy Period, Coverage Territory

Under this Coverage Form, we cover "accidents" and "losses" occurring:

- a. During the policy period shown in the Declarations; and
- b. Within the coverage territory.

The coverage territory is:

- (1) The United States of America;
- (2) The territories and possessions of the United States of America;
- (3) Puerto Rico;
- (4) Canada; and
- (5) Anywhere in the world if a covered "auto" of the private passenger type is leased, hired, rented or borrowed without a driver for a period of 30 days or less,

provided that the "insured's" responsibility to pay damages is determined in a "suit" on the merits, in the United States of America, the territories and possessions of the United States of America, Puerto Rico or Canada, or in a settlement we agree to.

We also cover "loss" to, or "accidents" involving, a covered "auto" while being transported between any of these places.

8. Two Or More Coverage Forms Or Policies Issued By Us

If this Coverage Form and any other Coverage Form or policy issued to you by us or any company affiliated with us applies to the same "accident", the aggregate maximum Limit of Insurance under all the Coverage Forms or policies shall not exceed the highest applicable Limit of Insurance under any one Coverage Form or policy. This condition does not apply to any Coverage Form or policy issued by us or an affiliated company specifically to apply as excess insurance over this Coverage Form.

SECTION V – DEFINITIONS

- A. "Accident" includes continuous or repeated exposure to the same conditions resulting in "bodily injury" or "property damage".
- B. "Auto" means:
 - 1. A land motor vehicle, "trailer" or semitrailer designed for travel on public roads; or
 - 2. Any other land vehicle that is subject to a compulsory or financial responsibility law or other motor vehicle insurance law where it is licensed or principally garaged.However, "auto" does not include "mobile equipment".
- C. "Bodily injury" means bodily injury, sickness or disease sustained by a person, including death resulting from any of these.
- D. "Covered pollution cost or expense" means any cost or expense arising out of:
 - 1. Any request, demand, order or statutory or regulatory requirement that any "insured" or others test for, monitor, clean up, remove, contain, treat, detoxify or neutralize, or in any way respond to, or assess the effects of, "pollutants"; or
 - 2. Any claim or "suit" by or on behalf of a governmental authority for damages because of testing for, monitoring, cleaning up, removing, containing, treating, detoxifying or neutralizing, or in any way responding to, or assessing the effects of, "pollutants".

"Covered pollution cost or expense" does not include any cost or expense arising out of the actual, alleged or threatened discharge, dispersal, seepage, migration, release or escape of "pollutants":

- a. That are, or that are contained in any property that is:

- (1) Being transported or towed by, handled or handled for movement into, onto or from the covered "auto";
 - (2) Otherwise in the course of transit by or on behalf of the "insured"; or
 - (3) Being stored, disposed of, treated or processed in or upon the covered "auto";
- b. Before the "pollutants" or any property in which the "pollutants" are contained are moved from the place where they are accepted by the "insured" for movement into or onto the covered "auto"; or
- c. After the "pollutants" or any property in which the "pollutants" are contained are moved from the covered "auto" to the place where they are finally delivered, disposed of or abandoned by the "insured".

Paragraph a. above does not apply to fuels, lubricants, fluids, exhaust gases or other similar "pollutants" that are needed for or result from the normal electrical, hydraulic or mechanical functioning of the covered "auto" or its parts, if:

- (1) The "pollutants" escape, seep, migrate or are discharged, dispersed or released directly from an "auto" part designed by its manufacturer to hold, store, receive or dispose of such "pollutants"; and
- (2) The "bodily injury", "property damage" or "covered pollution cost or expense" does not arise out of the operation of any equipment listed in Paragraph 6.b. or 6.c. of the definition of "mobile equipment".

Paragraphs b. and c. above do not apply to "accidents" that occur away from premises owned by or rented to an "insured" with respect to "pollutants" not in or upon a covered "auto" if:

- (a) The "pollutants" or any property in which the "pollutants" are contained are upset, overturned or damaged as a result of the maintenance or use of a covered "auto"; and
- (b) The discharge, dispersal, seepage, migration, release or escape of the "pollutants" is caused directly by such upset, overturn or damage.

- E. "Diminution in value" means the actual or perceived loss in market value or resale value which results from a direct and accidental "loss".
- F. "Employee" includes a "leased worker". "Employee" does not include a "temporary worker".
- G. "Insured" means any person or organization qualifying as an insured in the Who Is An Insured provision of the applicable coverage. Except with respect to the Limit of Insurance, the coverage afforded applies separately to each insured who is seeking coverage or against whom a claim or "suit" is brought.
- H. "Insured contract" means:
- 1. A lease of premises;
 - 2. A sidetrack agreement;
 - 3. Any easement or license agreement, except in connection with construction or demolition operations on or within 50 feet of a railroad;
 - 4. An obligation, as required by ordinance, to indemnify a municipality, except in connection with work for a municipality;
 - 5. That part of any other contract or agreement pertaining to your business (including an indemnification of a municipality in connection with work performed for a municipality) under which you assume the tort liability of another to pay for "bodily injury" or "property damage" to a third party or organization. Tort liability means a liability that would be imposed by law in the absence of any contract or agreement; or
 - 6. That part of any contract or agreement entered into, as part of your business, pertaining to the rental or lease, by you or any of your "employees", of any "auto". However, such contract or agreement shall not be considered an "insured contract" to the extent that it obligates you or any of your "employees" to pay for "property damage" to any "auto" rented or leased by you or any of your "employees".

An "insured contract" does not include that part of any contract or agreement:

- a. That indemnifies a railroad for "bodily injury" or "property damage" arising out of construction or demolition operations, within 50 feet of any railroad property and affecting any railroad bridge or trestle, tracks, roadbeds, tunnel, underpass or crossing;
- b. That pertains to the loan, lease or rental of an "auto" to you or any of your "employees", if the "auto" is loaned, leased or rented with a driver; or

- c. That holds a person or organization engaged in the business of transporting property by "auto" for hire harmless for your use of a covered "auto" over a route or territory that person or organization is authorized to serve by public authority.
- I. "Leased worker" means a person leased to you by a labor leasing firm under an agreement between you and the labor leasing firm to perform duties related to the conduct of your business. "Leased worker" does not include a "temporary worker".
- J. "Loss" means direct and accidental loss or damage.
- K. "Mobile equipment" means any of the following types of land vehicles, including any attached machinery or equipment:
 - 1. Bulldozers, farm machinery, forklifts and other vehicles designed for use principally off public roads;
 - 2. Vehicles maintained for use solely on or next to premises you own or rent;
 - 3. Vehicles that travel on crawler treads;
 - 4. Vehicles, whether self-propelled or not, maintained primarily to provide mobility to permanently mounted:
 - a. Power cranes, shovels, loaders, diggers or drills; or
 - b. Road construction or resurfacing equipment such as graders, scrapers or rollers;
 - 5. Vehicles not described in Paragraph 1., 2., 3. or 4. above that are not self-propelled and are maintained primarily to provide mobility to permanently attached equipment of the following types:
 - a. Air compressors, pumps and generators, including spraying, welding, building cleaning, geophysical exploration, lighting and well-servicing equipment; or
 - b. Cherry pickers and similar devices used to raise or lower workers; or
 - 6. Vehicles not described in Paragraph 1., 2., 3. or 4. above maintained primarily for purposes other than the transportation of persons or cargo. However, self-propelled vehicles with the following types of permanently attached equipment are not "mobile equipment" but will be considered "autos":
 - a. Equipment designed primarily for:
 - (1) Snow removal;
 - (2) Road maintenance, but not construction or resurfacing; or
 - (3) Street cleaning;
 - b. Cherry pickers and similar devices mounted on automobile or truck chassis and used to raise or lower workers; and
 - c. Air compressors, pumps and generators, including spraying, welding, building cleaning, geophysical exploration, lighting or well-servicing equipment.

However, "mobile equipment" does not include land vehicles that are subject to a compulsory or financial responsibility law or other motor vehicle insurance law where it is licensed or principally garaged. Land vehicles subject to a compulsory or financial responsibility law or other motor vehicle insurance law are considered "autos".
- L. "Pollutants" means any solid, liquid, gaseous or thermal irritant or contaminant, including smoke, vapor, soot, fumes, acids, alkalis, chemicals and waste. Waste includes materials to be recycled, reconditioned or reclaimed.
- M. "Property damage" means damage to or loss of use of tangible property.
- N. "Suit" means a civil proceeding in which:
 - 1. Damages because of "bodily injury" or "property damage"; or
 - 2. A "covered pollution cost or expense";
 to which this insurance applies, are alleged.
 "Suit" includes:
 - a. An arbitration proceeding in which such damages or "covered pollution costs or expenses" are claimed and to which the "insured" must submit or does submit with our consent; or
 - b. Any other alternative dispute resolution proceeding in which such damages or "covered pollution costs or expenses" are claimed and to which the insured submits with our consent.
- O. "Temporary worker" means a person who is furnished to you to substitute for a permanent "employee" on leave or to meet seasonal or short-term workload conditions.
- P. "Trailer" includes semitrailer.

THIS ENDORSEMENT CHANGES THE POLICY. PLEASE READ IT CAREFULLY.

ADDITIONAL INSURED – OWNERS, LESSEES OR CONTRACTORS – SCHEDULED PERSON OR ORGANIZATION

This endorsement modifies insurance provided under the following:

COMMERCIAL GENERAL LIABILITY COVERAGE PART

SCHEDULE

Name Of Additional Insured Person(s) Or Organization(s)	Location(s) Of Covered Operations
County of Los Angeles Department of Public Works Administrative Services Division - 9th Floor 900 S. Fremont Avenue Alhambra, CA 91803-1331	All Locations as required per written contract.
Information required to complete this Schedule, if not shown above, will be shown in the Declarations.	

A. Section II – Who Is An Insured is amended to include as an additional insured the person(s) or organization(s) shown in the Schedule, but only with respect to liability for "bodily injury", "property damage" or "personal and advertising injury" caused, in whole or in part, by:

1. Your acts or omissions; or
2. The acts or omissions of those acting on your behalf;

in the performance of your ongoing operations for the additional insured(s) at the location(s) designated above.

However:

1. The insurance afforded to such additional insured only applies to the extent permitted by law; and
2. If coverage provided to the additional insured is required by a contract or agreement, the insurance afforded to such additional insured will not be broader than that which you are required by the contract or agreement to provide for such additional insured.

B. With respect to the insurance afforded to these additional insureds, the following additional exclusions apply:

This insurance does not apply to "bodily injury" or "property damage" occurring after:

1. All work, including materials, parts or equipment furnished in connection with such work, on the project (other than service, maintenance or repairs) to be performed by or on behalf of the additional insured(s) at the location of the covered operations has been completed; or
2. That portion of "your work" out of which the injury or damage arises has been put to its intended use by any person or organization other than another contractor or subcontractor engaged in performing operations for a principal as a part of the same project.

C. With respect to the insurance afforded to these additional insureds, the following is added to **Section III – Limits Of Insurance:**

If coverage provided to the additional insured is required by a contract or agreement, the most we will pay on behalf of the additional insured is the amount of insurance:

1. Required by the contract or agreement; or

2. Available under the applicable limits of insurance;
whichever is less.

This endorsement shall not increase the applicable limits of insurance.

THIS ENDORSEMENT CHANGES THE POLICY. PLEASE READ IT CAREFULLY.

**WAIVER OF TRANSFER OF RIGHTS OF RECOVERY
AGAINST OTHERS TO US (WAIVER OF SUBROGATION)**

This endorsement modifies insurance provided under the following:

- COMMERCIAL GENERAL LIABILITY COVERAGE PART
- ELECTRONIC DATA LIABILITY COVERAGE PART
- LIQUOR LIABILITY COVERAGE PART
- POLLUTION LIABILITY COVERAGE PART DESIGNATED SITES
- POLLUTION LIABILITY LIMITED COVERAGE PART DESIGNATED SITES
- PRODUCTS/COMPLETED OPERATIONS LIABILITY COVERAGE PART
- RAILROAD PROTECTIVE LIABILITY COVERAGE PART
- UNDERGROUND STORAGE TANK POLICY DESIGNATED TANKS

SCHEDULE

<p>Name Of Person(s) Or Organization(s): Any person or organization where required by written contract provided that such contract was executed prior to the date of loss (as permissable by law)</p>

Information required to complete this Schedule, if not shown above, will be shown in the Declarations.

The following is added to Paragraph **8. Transfer Of Rights Of Recovery Against Others To Us** of **Section IV – Conditions:**

We waive any right of recovery against the person(s) or organization(s) shown in the Schedule above because of payments we make under this Coverage Part. Such waiver by us applies only to the extent that the insured has waived its right of recovery against such person(s) or organization(s) prior to loss. This endorsement applies only to the person(s) or organization(s) shown in the Schedule above.

ENDORSEMENT #TBD

This endorsement, effective 12:01 a.m., February 1, 2022 forms a part of Policy No. AEC004525207 issued to ZEREP MANAGEMENT CORPORATION by XL Insurance America.

THIS ENDORSEMENT CHANGES THE POLICY. PLEASE READ IT CAREFULLY.

AUTOMATIC ADDITIONAL INSURED

This endorsement modifies insurance provided under the following:

BUSINESS AUTO COVERAGE FORM
MOTOR CARRIER COVERAGE FORM
AUTO DEALERS COVERAGE FORM

- A. **COVERED AUTOS LIABILITY COVERAGE, Who Is An Insured**, is amended to include as an "insured" any person or organization you are required in a written contract to name as an additional insured, but only for "bodily injury" or "property damage" otherwise covered under this policy caused, in whole or in part, by the negligent acts or omissions of:
 - 1. You, while using a covered "auto"; or
 - 2. Any other person, except the additional insured or any employee or agent of the additional insured, operating a covered "auto" with your permission;

Provided that:

- a. The written contract is in effect during the policy period of this policy;
 - b. The written contract was signed by you and executed prior to the "accident" causing "bodily injury" or "property damage" for which liability coverage is sought; and
 - c. Such person or organization is an "insured" solely to the extent required by the contract, but in no event if such person or organization is solely negligent.
- B. The Limits of Insurance provided for the Additional Insured shall not be greater than those required by contract and, in no event shall the Limits of Insurance set forth in this policy be increased by the contract.

- C. **General Conditions, Other Insurance** is amended as follows:

Any coverage provided hereunder shall be excess over any other valid and collectible insurance available to the additional insured whether such insurance is primary, excess, contingent or on any other basis unless the contract specifically requires that this policy be primary.

All terms, conditions, exclusions and limitations of this policy shall apply to the liability coverage provided to any additional insured, and in no event shall such coverage be enlarged or expanded by reason of the contract.

ENDORSEMENT #004

This endorsement, effective 12:01 a.m., February 1, 2021 forms a part of Policy No. PEC001960405 issued to GRAND CENTRAL RECYCLING AND TRANSFER STATION, INC. by Indian Harbor Insurance Company.

THIS ENDORSEMENT CHANGES THE POLICY. PLEASE READ IT CAREFULLY.

ADDITIONAL NAMED INSURED SCHEDULE

This endorsement modifies insurance provided under the following:

POLLUTION AND REMEDIATION LEGAL LIABILITY POLICY

It is agreed that this Policy is amended as follows:

The following are included as an **Additional Named Insured**:

THE COUNTY OF LOS ANGELES, A SUBDIVISION OF CALIFORNIA, BODY CORPORATE AND POLICITC
ZEREP MANAGEMENT CORPORATION
VALLEY VISTA SERVICES, INC.
CITY OF INDUSTRY DISPOSAL COMPANY, INC. DBA GRAND CENTRAL RECYCLING
VALLEY VISTA SERVICES DBA VALLEY VISTA SERVICES OF ORANGE COUNTY

All other terms and conditions remain the same.



ADDITIONAL REMARKS SCHEDULE

AGENCY Solid Waste Insurance Marketing		License # 0B29370	NAMED INSURED Valley Vista Services, Inc. 17445 East Railroad Street City Of Industry, CA 91748
POLICY NUMBER SEE PAGE 1			
CARRIER SEE PAGE 1	NAIC CODE SEE P 1	EFFECTIVE DATE: SEE PAGE 1	

ADDITIONAL REMARKS

THIS ADDITIONAL REMARKS FORM IS A SCHEDULE TO ACORD FORM.
FORM NUMBER: ACORD 25 FORM TITLE: Certificate of Liability Insurance

Description of Operations/Locations/Vehicles:
Additional Named Insureds:
Zerep Management Corporation
Valley Vista Services, Incorporated
City of Industry Disposal Company, Inc.
Valley Vista Disposal
Vincent's General Services, Inc.
Valley Vista Services, Inc. DBA Valley Vista Services of Orange County
Grand Central Recycling & Transfer Station, Inc.
Municipal Maintenance, Inc.
Pomona Valley Transfer Station

Contract No. #003550; #003229; #003095

Waiver of Our Right to Recover From Others Endorsement - California WC 04 03 06 (04 84)

CALIFORNIA CANCELEATION ENDORSEMENT

This endorsement applies only to the insurance provided by the policy because California is shown in Item 3.A. of the Information Page.

The cancelation condition in Part Six (Conditions) of the policy is replaced by these conditions:

Cancelation:

1. You may cancel this policy. You must mail or deliver advance written notice to us stating when the cancelation is to take effect.
2. We may cancel this policy for one or more of the following reasons:
 - a. Non-payment of premium;
 - b. Failure to report payroll;
 - c. Failure to permit us to audit payroll as required by the terms of this policy or of a previous policy issued by us;
 - d. Failure to pay any additional premium resulting from an audit of payroll required by the terms of this policy or any previous policy issued by us;
 - e. Material misrepresentation made by you or your agent;
 - f. Failure to cooperate with us in the investigation of a claim;
 - g. Failure to comply with Federal or State safety orders;
 - h. Failure to comply with written recommendations of our designated loss control representatives;
 - i. The occurrence of a material change in the ownership of your business;
 - j. The occurrence of any change in your business or operations that materially increases the hazard for frequency or severity of loss;
 - k. The occurrence of any change in your business or operation that requires additional or different classification for premium calculation;
 - l. The occurrence of any change in your business or operation which contemplates an activity excluded by our reinsurance treaties.
3. If we cancel your policy for any of the reasons listed in (a) through (f), we will give you 10 days advance written notice, stating when the cancelation is to take effect. Mailing that notice to you at your mailing address shown in Item 1 of the Information Page will be sufficient to prove notice. If we cancel your policy for any of the reasons listed in Items (g) through (l), we will give you 30 days advance written notice; however, we agree that in the event of cancelation and reissuance of a policy effective upon a material change in ownership or operations, notice will not be provided.
4. The policy period will end on the day and hour stated in the cancelation notice.

This endorsement changes the policy to which it is attached and, unless otherwise stated, is effective on the date issued at 12:01 A.M. standard time at your mailing address shown in the policy. **The information below is required only when this endorsement is issued subsequent to commencement of the policy.**

Endorsement Effective 10/01/2021

Policy No. 21J WS 10324

Insured Zerep Management Corporation

Endorsement No. 14

Countersigned By Mark E. Schmittlein

TRG/Pasadena

WC 04 06 01A (12 93)



WAIVER OF OUR RIGHT TO RECOVER FROM OTHERS ENDORSEMENT - CALIFORNIA

We have the right to recover our payments from anyone liable for an injury covered by this policy. We will not enforce our right against the person or organization named in the Schedule. (This agreement applies only to the extent that you perform work under a written contract that requires you to obtain this agreement from us.)

You must maintain payroll records accurately segregating the remuneration of your employees while engaged in the work described in the Schedule.

The additional premium for this endorsement shall be 2% of the California workers' compensation premium otherwise due on such remuneration.

SCHEDULE

Person or Organization	SCHEDULE	Job Description
-------------------------------	-----------------	------------------------

Blanket Waiver:

Any person or organization for whom the insured, has agreed by written contract to furnish this waiver

This endorsement changes the policy to which it is attached and, unless otherwise stated, is effective on the date issued at 12:01 A.M. standard time at your mailing address shown in the policy. **The information below is required only when this endorsement is issued subsequent to commencement of the policy.**

Endorsement Effective 10/01/2020

Policy No. 20J WS 10324

Insured Zerep Management Corporation

Endorsement No. 5

Countersigned By Wayne Bryan

TRG/Pasadena

WC 04 03 06 (04 84)

Signed and sealed this 19th day of May, 2022.

Principal Valley Vista Services, Inc.

Surety RLI Insurance Company

BY: [Signature] (Seal)

BY: [Signature] (Seal)

Name and Title David M. Perez Sec

Margareta T. Thorsen

Attorney-in-fact

BY: _____

Name and Title

APPROVED AS TO FORM:

DAWYN R. HARRISON

Acting County Counsel

BY: Talin Halabi
Deputy

CALIFORNIA ALL-PURPOSE ACKNOWLEDGMENT

CIVIL CODE § 1189

A notary public or other officer completing this certificate verifies only the identity of the individual who signed the document to which this certificate is attached, and not the truthfulness, accuracy, or validity of that document.

State of California }
County of Los Angeles }
On 5/19/22 before me, Sonia Vizcarrondo, Notary Public
Date Here Insert Name and Title of the Officer
personally appeared Margareta T. Thorsen
Name(s) of Signer(s)

who proved to me on the basis of satisfactory evidence to be the person(s) whose name(s) is/are subscribed to the within instrument and acknowledged to me that he/she/they executed the same in his/her/their authorized capacity(ies), and that by his/her/their signature(s) on the instrument the person(s), or the entity upon behalf of which the person(s) acted, executed the instrument.

I certify under PENALTY OF PERJURY under the laws of the State of California that the foregoing paragraph is true and correct.

WITNESS my hand and official seal.



Place Notary Seal and/or Stamp Above

Signature Sonia Vizcarrondo
Signature of Notary Public

OPTIONAL

Completing this information can deter alteration of the document or fraudulent reattachment of this form to an unintended document.

Description of Attached Document

Title or Type of Document: _____

Document Date: _____ Number of Pages: _____

Signer(s) Other Than Named Above: _____

Capacity(ies) Claimed by Signer(s)

Signer's Name: _____ Signer's Name: _____

Corporate Officer – Title(s): _____ Corporate Officer – Title(s): _____

Partner – Limited General Partner – Limited General

Individual Attorney in Fact Individual Attorney in Fact

Trustee Guardian of Conservator Trustee Guardian of Conservator

Other: _____ Other: _____

Signer is Representing: _____ Signer is Representing: _____

POWER OF ATTORNEY

RLI Insurance Company Contractors Bonding and Insurance Company

9025 N. Lindbergh Dr. Peoria, IL 61615
Phone: 800-645-2402

Know All Men by These Presents:

That this Power of Attorney is not valid or in effect unless attached to the bond which it authorizes executed, but may be detached by the approving officer if desired.

That **RLI Insurance Company** and/or **Contractors Bonding and Insurance Company**, each an Illinois corporation, (separately and together, the "Company") do hereby make, constitute and appoint:

Margareta T. Thorsen

in the City of Pasadena, State of California its true and lawful Agent(s) and Attorney(s) in Fact, with full power and authority hereby conferred, to sign, execute, acknowledge and deliver for and on its behalf as Surety, in general, any and all bonds and undertakings in an amount not to exceed Twenty Five Million Dollars (\$25,000,000.00) for any single obligation.

The acknowledgment and execution of such bond by the said Attorney in Fact shall be as binding upon the Company as if such bond had been executed and acknowledged by the regularly elected officers of the Company.

RLI Insurance Company and/or **Contractors Bonding and Insurance Company**, as applicable, have each further certified that the following is a true and exact copy of a Resolution adopted by the Board of Directors of each such corporation, and is now in force, to-wit:

"All bonds, policies, undertakings, Powers of Attorney or other obligations of the corporation shall be executed in the corporate name of the Company by the President, Secretary, any Assistant Secretary, Treasurer, or any Vice President, or by such other officers as the Board of Directors may authorize. The President, any Vice President, Secretary, any Assistant Secretary, or the Treasurer may appoint Attorneys in Fact or Agents who shall have authority to issue bonds, policies or undertakings in the name of the Company. The corporate seal is not necessary for the validity of any bonds, policies, undertakings, Powers of Attorney or other obligations of the corporation. The signature of any such officer and the corporate seal may be printed by facsimile."

IN WITNESS WHEREOF, the **RLI Insurance Company** and/or **Contractors Bonding and Insurance Company**, as applicable, have caused these presents to be executed by its respective Vice President with its corporate seal affixed this 18th day of March, 2021.



RLI Insurance Company
Contractors Bonding and Insurance Company
By: Barton W. Davis
Barton W. Davis Vice President

State of Illinois }
County of Peoria } SS

On this 18th day of March, 2021, before me, a Notary Public, personally appeared Barton W. Davis, who being by me duly sworn, acknowledged that he signed the above Power of Attorney as the aforesaid officer of the **RLI Insurance Company** and/or **Contractors Bonding and Insurance Company** and acknowledged said instrument to be the voluntary act and deed of said corporation.

By: Catherine D. Glover
Catherine D. Glover Notary Public

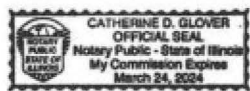

CERTIFICATE

I, the undersigned officer of **RLI Insurance Company** and/or **Contractors Bonding and Insurance Company**, do hereby certify that the attached Power of Attorney is in full force and effect and is irrevocable; and furthermore, that the Resolution of the Company as set forth in the Power of Attorney, is now in force. In testimony whereof, I have hereunto set my hand and the seal of the **RLI Insurance Company** and/or **Contractors Bonding and Insurance Company** this 18th day of May, 2022.

RLI Insurance Company
Contractors Bonding and Insurance Company
By: Jeffrey D. Fick
Jeffrey D. Fick Corporate Secretary

0475359620212

A0058D19

CALIFORNIA ACKNOWLEDGMENT

CIVIL CODE § 1189

A notary public or other officer completing this certificate verifies only the identity of the individual who signed the document to which this certificate is attached, and not the truthfulness, accuracy, or validity of that document.

State of California }
County of LOS ANGELES }

On 5-23-2022 before me, JESSE QUINTANA - NOTARY PUBLIC
Date Here Insert Name and Title of the Officer

personally appeared DAVID M. PEREZ
Name(s) of Signer(s)

who proved to me on the basis of satisfactory evidence to be the person(s) whose name(s) is/are subscribed to the within instrument and acknowledged to me that he/she/they executed the same in his/her/their authorized capacity(ies), and that by his/her/their signature(s) on the instrument the person(s), or the entity upon behalf of which the person(s) acted, executed the instrument.

I certify under PENALTY OF PERJURY under the laws of the State of California that the foregoing paragraph is true and correct.

WITNESS my hand and official seal.



Place Notary Seal and/or Stamp Above

Signature Jesse Quintana
Signature of Notary Public

OPTIONAL

Completing this information can deter alteration of the document or fraudulent reattachment of this form to an unintended document.

Description of Attached Document

Title or Type of Document: _____

Document Date: _____ Number of Pages: _____

Signer(s) Other Than Named Above: _____

Capacity(ies) Claimed by Signer(s)

Signer's Name: _____ Signer's Name: _____

Corporate Officer – Title(s): _____ Corporate Officer – Title(s): _____

Partner – Limited General Partner – Limited General

Individual Attorney in Fact Individual Attorney in Fact

Trustee Guardian or Conservator Trustee Guardian or Conservator

Other: _____ Other: _____

Signer is Representing: _____ Signer is Representing: _____

Exhibit 17 – Contractor Documentation

Item B.7 - Internal Revenue Service Notice 1015 (Part 8B1 of Exhibit 5)

This item consists of 2 pages (including this page).



Department of the Treasury
Internal Revenue Service

Notice 1015

(Rev. December 2021)

Have You Told Your Employees About the Earned Income Credit (EIC)?

What Is the EIC?

The EIC is a refundable tax credit for certain workers.

Which Employees Must I Notify About the EIC?

You must notify each employee who worked for you at any time during the year and from whose wages you did not withhold income tax. However, you do not have to notify any employee who claimed exemption from withholding on Form W-4, Employee's Withholding Certificate.

Note: You are encouraged to notify each employee whose wages for 2021 are less than \$57,414 that he or she may be eligible for the EIC.

How and When Must I Notify My Employees?

You must give the employee one of the following.

- The IRS Form W-2, Wage and Tax Statement, which has the required information about the EIC on the back of Copy B.
- A substitute Form W-2 with the same EIC information on the back of the employee's copy that is on Copy B of the IRS Form W-2.
- Notice 797, Possible Federal Tax Refund Due to the Earned Income Credit (EIC).
- Your written statement with the same wording as Notice 797.

If you give an employee a Form W-2 on time, no further notice is necessary if the Form W-2 has the required information about the EIC on the back of the employee's copy. If you give an employee a substitute Form W-2, but it does not have the required information, you

must notify the employee within 1 week of the date the substitute Form W-2 is given. If Form W-2 is required but is not given on time, you must give the employee Notice 797 or your written statement by the date Form W-2 is required to be given. If Form W-2 is not required, you must notify the employee by February 7, 2022.

You must hand the notice directly to the employee or send it by first-class mail to the employee's last known address. You will not meet the notification requirements by posting Notice 797 on an employee bulletin board or sending it through office mail. However, you may want to post the notice to help inform all employees of the EIC. You can download copies of the notice at www.irs.gov/FormsPubs. Or you can go to www.irs.gov/OrderForms to order it.

How Will My Employees Know if They Can Claim the EIC?

The basic requirements are covered in Notice 797. For more detailed information, the employee needs to see Pub. 596, Earned Income Credit (EIC), or the instructions for Forms 1040 and 1040-SR.

How Do My Employees Claim the EIC?

An eligible employee claims the EIC on his or her 2021 tax return. Even an employee who has no tax withheld from wages and owes no tax may claim the EIC and ask for a refund, but he or she must file a tax return to do so. For example, if an employee has no tax withheld in 2021 and owes no tax but is eligible for a credit of \$800, he or she must file a 2021 tax return to get the \$800 refund.

Notice **1015** (Rev. 12-2021)
Cat. No. 205991

Exhibit 17 – Contractor Documentation

Item B.8 - CONTRACTOR's EEO Certification (Part 8D3 of Exhibit 5)

This item consists of 2 pages (including this page).

PROPOSER'S EQUAL EMPLOYMENT OPPORTUNITY CERTIFICATION

Proposer's Name VALLEY VISTA SERVICES INC.
Address 17445 E. RAILROAD STREET CITY OF INDUSTRY, CA 91748
Internal Revenue Service Employer Identification Number 95-4460181

In accordance with Los Angeles County Code, Section 4.32.010, the Proposer certifies and agrees that all persons employed by it, its affiliates, subsidiaries, or holding companies are and will be treated equally by the firm without regard to or because of race, religion, ancestry, national origin, or sex and in compliance with all antidiscrimination laws of the United States of America and the State of California.

1.	The proposer has a written policy statement prohibiting any discrimination in all phases of employment.	<input checked="" type="checkbox"/> YES <input type="checkbox"/> NO
2.	The proposer periodically conducts a self-analysis or utilization analysis of its work force.	<input checked="" type="checkbox"/> YES <input type="checkbox"/> NO
3.	The proposer has a system for determining if its employment practices are discriminatory against protected groups.	<input checked="" type="checkbox"/> YES <input type="checkbox"/> NO
4.	Where problem areas are identified in employment practices, the proposer has a system for taking reasonable corrective action to include establishment of goals and timetables.	<input checked="" type="checkbox"/> YES <input type="checkbox"/> NO

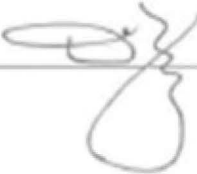
Proposer VALLEY VISTA SERVICES INC.	
Authorized representative DAVID M. PEREZ - SECRETARY	
Signature 	Date JAN 31, 2022

Item B.9 - Sharps Collection (Item F1a of Exhibit 3A1)

This item consists of 2 pages (including this page).

Sharps Collection Program

Within one week after customers' request, Valley Vista Services will provide said subscription customer, at the customers' premises, without surcharge to the County or customer, an approved container for sharps disposal in accordance with Applicable Laws.

Valley Vista Services will provide 1-gallon and/or 2-gallon SHARP containers pre-approved by the County of Los Angeles. Upon request by the subscriber, Valley Vista Services personnel will personally and promptly deliver an empty Sharps container kit.

Each kit includes:

1. A government-approved plastic container specially-designed for sharps waste
2. Postage-prepaid mail-back shipping box
3. Pre-addressed shipping labels
4. Prepaid disposal

Valley Vista Services has identified Stericycle as their container and autoclave vendor for sharps disposal. Stericycle is the nation's largest supplier and processor of medical and sharps waste.

Once the pre-approved container is full, the subscriber completes a simple tracking form and ships the container back to Stericycle in the mail-back box. Upon receipt, Stericycle documents the delivery and properly treats and destroys the sharps container and its contents. It is convenient, safe, and confidential.

Upon shipment to Stericycle, the subscriber shall be required to contact Valley Vista Services for a new replacement container. Valley Vista Services shall distribute the 1-gallon or 2-gallon containers to each subscriber up to four times per year. If multiple residents in the same dwelling require additional capacity, Valley Vista Services may increase the container size and/or frequency upon mutual agreement with the subscriber, County staff and Valley Vista Services management.

Valley Vista Services will collect, transport and dispose of materials in accordance with Applicable Laws and will provide the following:

- A. Distribution of County approved Sharps containers (to include outreach efforts)
- B. Collections of Sharps containers
- C. Proper handling and disposal of containers in accordance with Applicable Laws.

Exhibit 17 – Contractor Documentation

Item B.10 - Director-Approved Subcontractors

This item consists of 2 pages (including this page).

Valley Vista Services will not be utilizing any Subcontractors.

Exhibit 17 – Contractor Documentation

Item B.11 - Backup Service Plan (Section 11C)

This item consists of 3 pages (including this page).

Valley Vista Services shall implement its Backup Service Plan within seven days of Director Request if Customer's Solid Waste is not collected at Customer's Set-Out Site or Abandoned Waste is not collected for any reason, including uncontrollable circumstances. An example is if Valley Vista Services drivers' strike or it is not possible to provide Contract Services in difficult to service areas due to severe weather conditions, especially on hillsides. In the event there is a protracted service disruption due to any cause, Valley Vista Services will institute many proactive actions to sustain Solid Waste Collection Services. Since Customers are expecting Collection, Transportation, and Disposal services that Valley Vista Services is not providing, Valley Vista Services shall not charge Customer or COUNTY for any of the services described below.

1. Provide Conveniently Located Dumpsters or Roll-off Containers

Valley Vista Services will place 3 or 4-yard Dumpsters and/or roll-off Containers throughout the community in key locations approved by Director.

2. Offer Self-Hauling Solid Waste to a Facility

Valley Vista Services will offer each Occupant the option of direct hauling and disposing of their solid waste at a facility normally used by Valley Vista Services for this Contract, 6 days per week. Valley Vista Services shall only charge the Customer for disposal costs for quantities beyond the Customer's normal service levels as evident in a copy of a recent bill provided by the Customer or Occupant. For example, a resident with 96-gallon Refuse, Recyclables and Green Waste Carts may dispose up to 0.5 cubic yards of Refuse and Divert up to 0.5 cubic yards of Recyclables and Green Waste each week.

Additionally, if Director determines the distance to the facilities is too far from Occupants, Valley Vista Services will arrange for a local facility to allow each Occupant to drop-off the Solid Waste.

3. Inform Customers of Temporary Procedures

Valley Vista Services guarantees the above service and disposal options will be made readily available to each Occupant. Valley Vista Services will provide Customers and Occupants with information on where and how to dispose of their solid waste by the following means:

- A phone option on its customer service line to hear a taped looped message.
- Arrange for the broadcast of COUNTY's 30-second Public Service Announcement video on local cable access channels with Valley Vista Services to customize it to the situation, such as having text appear on the screen announcing date, times, and addresses.

- Contact local print media and produce a press release.
- Contact Customers and Occupants via phone, email, or text messages.

4. Credit Policy for Missed Contract Services

A. Missed Collection

Since Customer is expecting a Collection Service not provided, Valley Vista Services shall credit Customer for each missed collection. For example, if a strike disrupts 2 weeks of the 4 Collections in a month, Valley Vista Services would credit Customer ½ of that month's fee toward the next month's fee.

B. Other Customer Services

When Valley Vista Services is unable to offer Customer Services other than curbside collection, such as Annual Curbside Cleanup, Mulch/Compost Giveaway events, or other required services, Valley Vista Services shall provide evidence of cost associated with those services and offer alternate services acceptable to Director.

5. Provide Replacement Drivers and Security

Valley Vista Services shall use Reasonable Business Efforts to require all properly trained and licensed employees to operate Collection Vehicles to maintain core Disposal and Diversion services. As described in the above paragraphs, Valley Vista Services shall be properly staffed to provide drop-off services for each Occupant. In addition to Valley Vista Services staff, Valley Vista Services shall use drivers or Vehicles from other operations and other waste haulers.

Finally, in cases of a strike, Valley Vista Services shall work closely with a private security firm to guarantee a safe and consistent operation.

6. Identify Customers Requiring Priority Service

Valley Vista Services shall prioritize public safety and emergency uses, and prioritize collection services to those locations in order to maintain health and safety measures. These service locations will be notified of any changes to service schedules or locations

Exhibit 17 – Contractor Documentation

Item B.12 - Key Personnel (Section 4J)

This item consists of 2 pages (including this page).

CONTRACT SERVICES MANAGERS	
David M Perez – President	626-855-5555 dmperez@valleyvistaservices.com
Susan Silvestri – Office Manager	626-855-5528 susans@myvvs.com
Jesse Quintana – Controller	626-855-5535 jquintana@zerepmanagement.com
Rodolfo Fernandez – Operations Manager	626-855-5506 rudyf@myvvs.com
AUTHORIZED REPRESENTATIVES	
David M Perez – President	626-855-5555 dmperez@valleyvistaservices.com
LEAD PERSON	
Grisell Vasquez – Customer Service Supervisor	626-855-5638 grisellv@myvvs.com
EMERGENCY CONTACT (outside Contractor's office hours)	
Rudy Fernandez – Operations Manager Cell # (626) 945-0027	
KEY PERSONNEL	
Felix Zamora – Route Supervisor Cell # (626) 523-0617	Erika Santillan – Assistant Operations Manager Cell # (626) 277-2244
Jose Serrano – Operations Assistant Cell # (909) 656-5420	
SERVICES SAFETY OFFICIAL	
Albert Moreno – Loss/Risk Manager	626-855-5536 albertm@zerepmanagement.com

Exhibit 17 – Contractor Documentation

Item B.13 - Route Maps

This item consists of 7 pages (including this page).

MONDAY LAC ROUTES

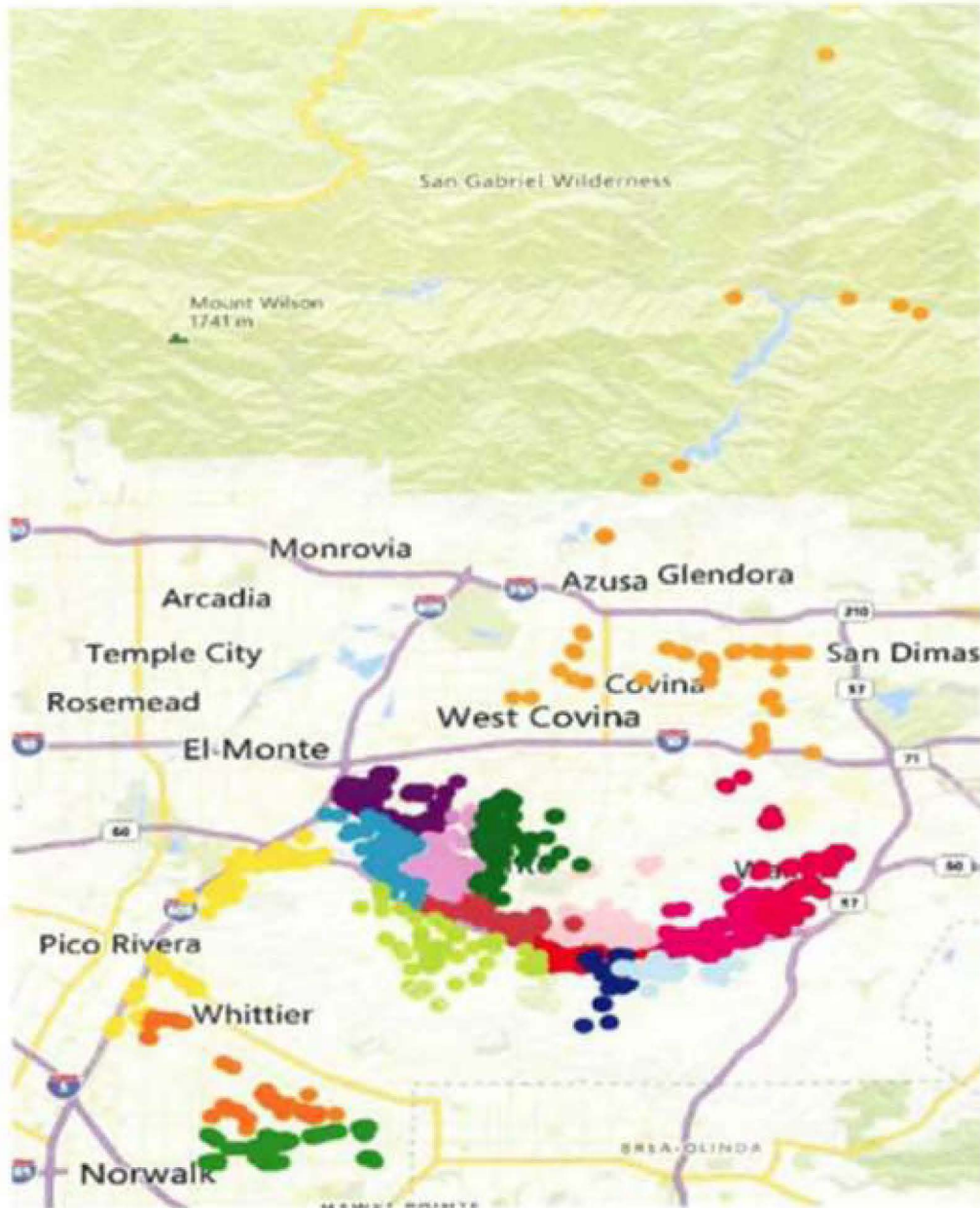

WEDNESDAY LAC ROUTES

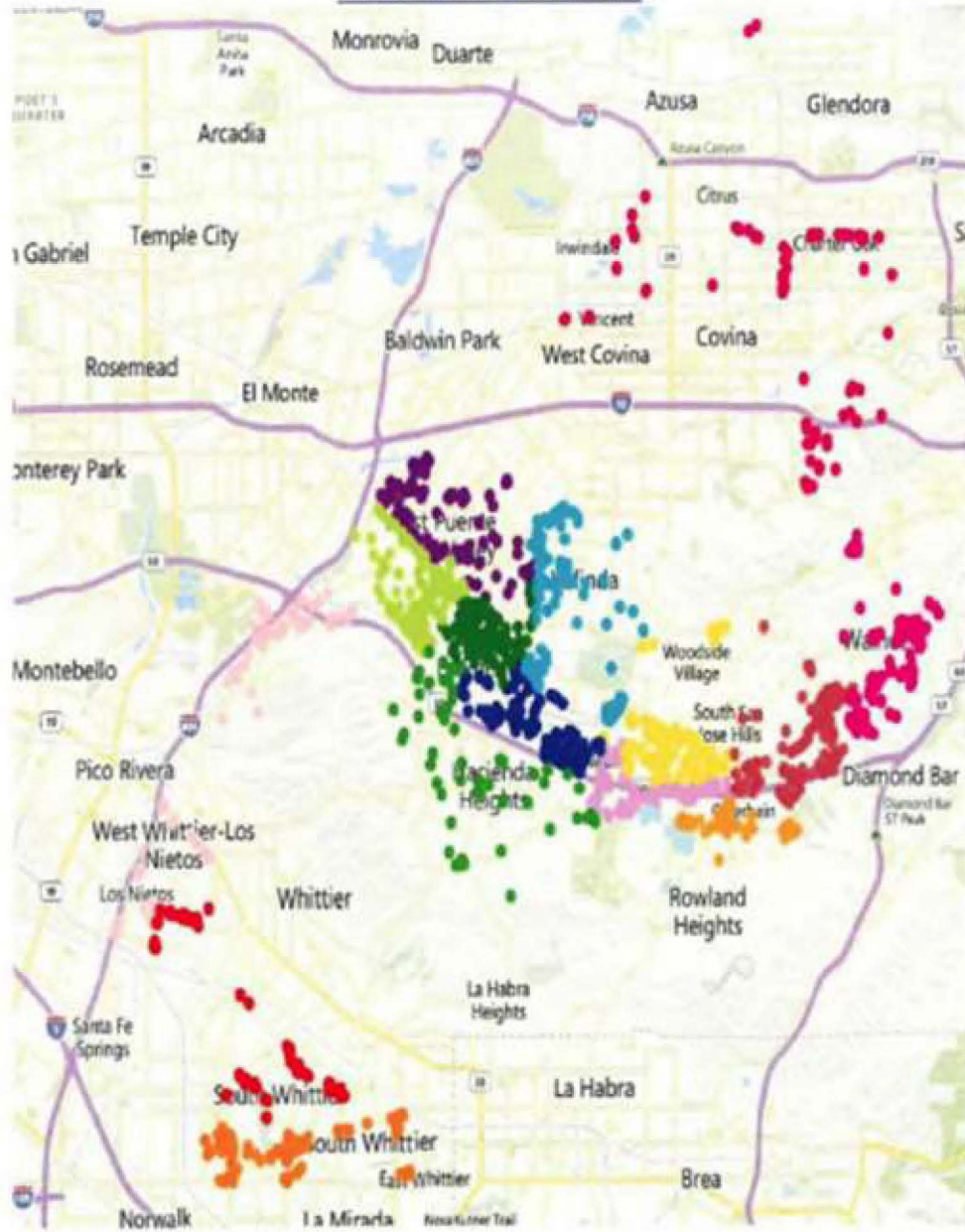

THURSDAY LAC ROUTES

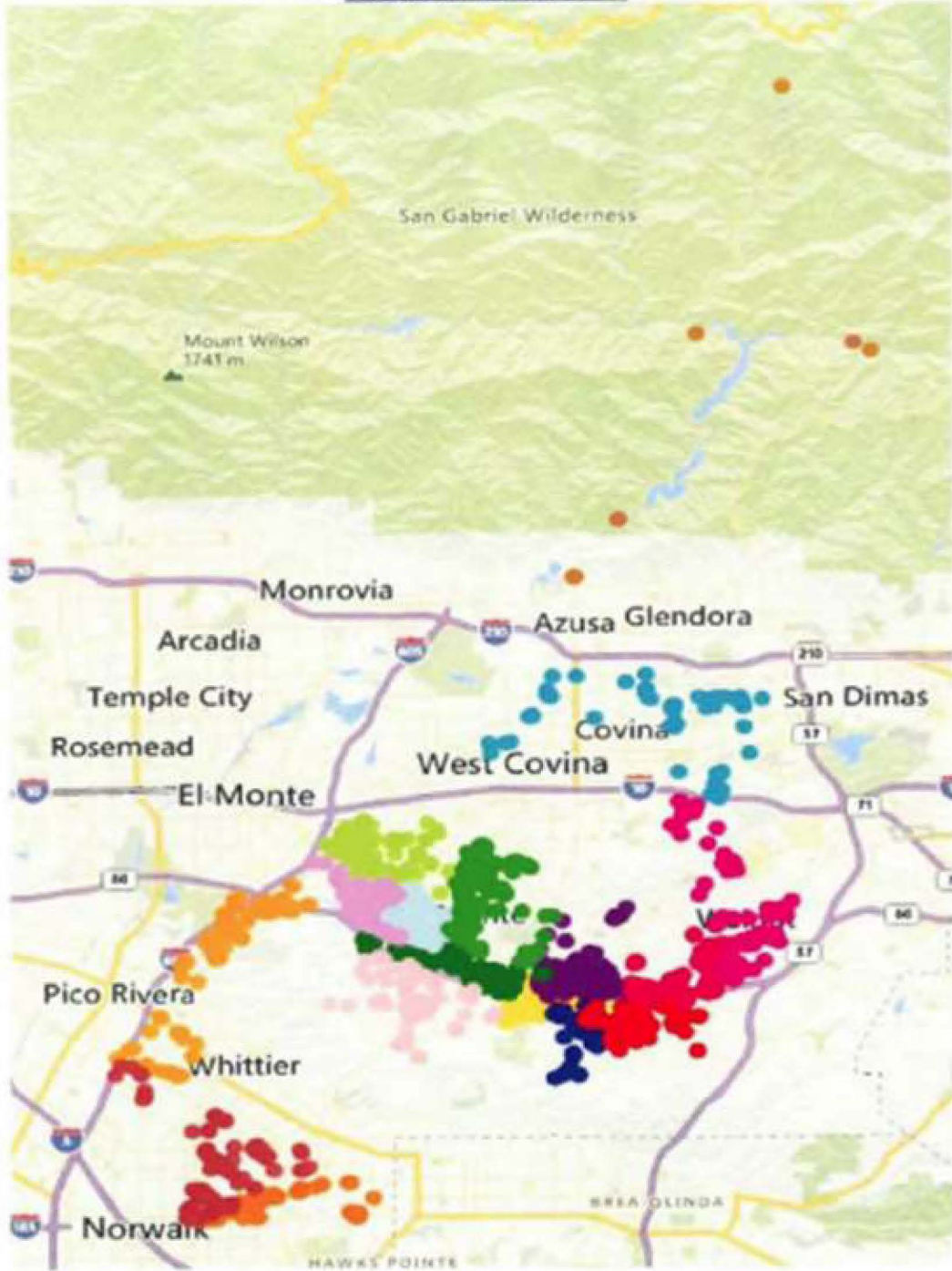

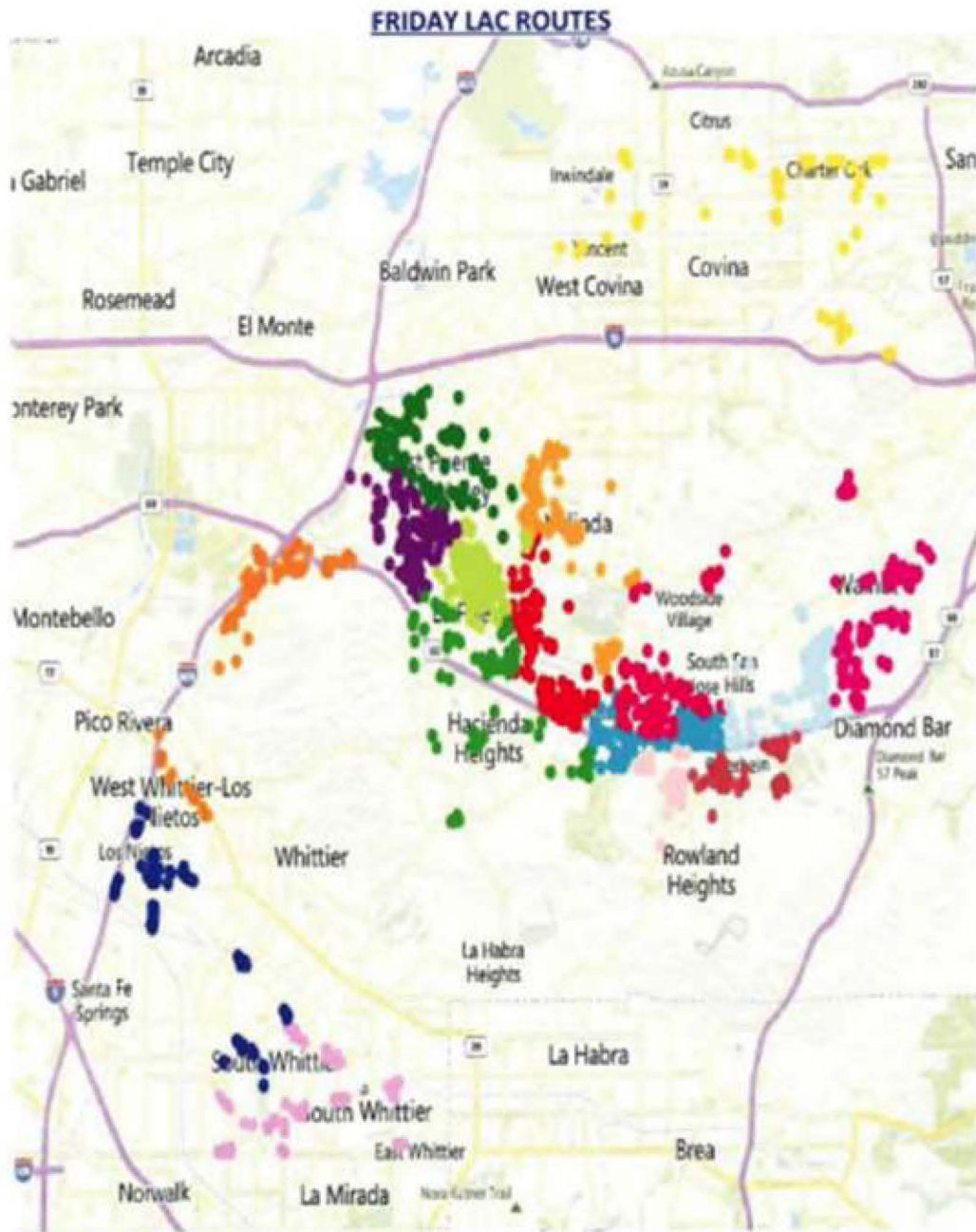

SATURDAY LAC ROUTES

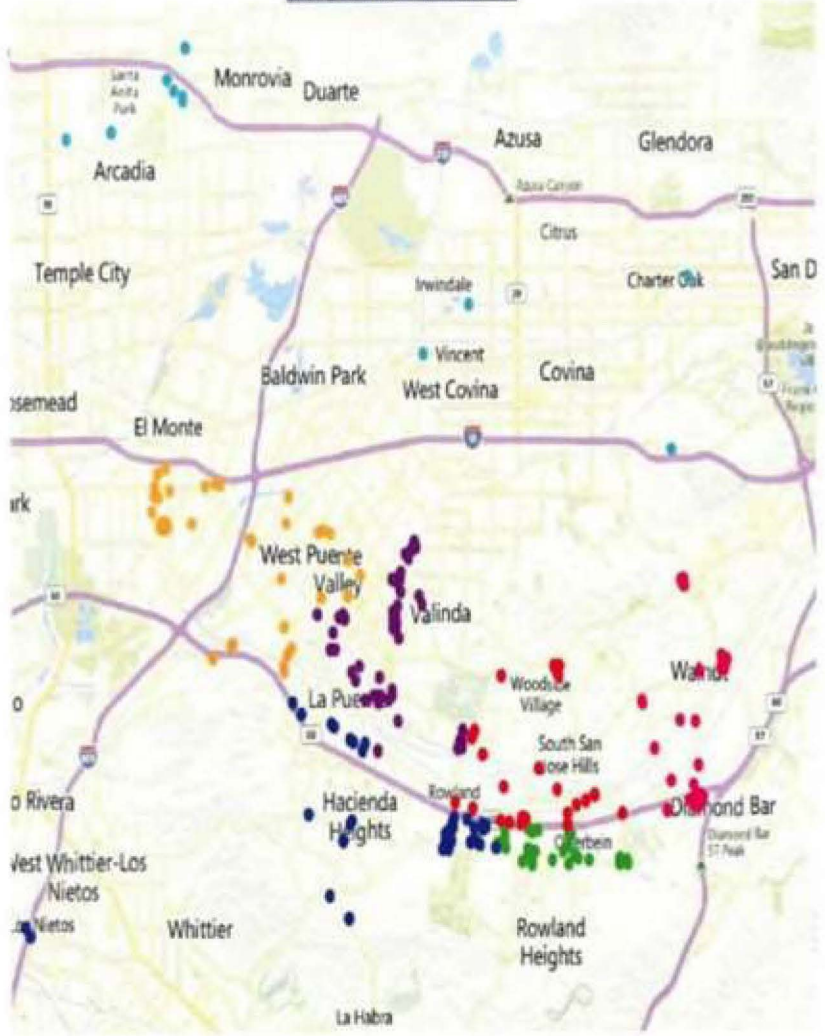

Exhibit 17 – Contractor Documentation

Item B.14 - Collection Schedule (Item A4 of Exhibit 3A1)

This item consists of 2 pages (including this page).

Valley Vista will collect all materials from customers Monday through Saturday between the hours of 6:00 am to 6:00 pm while avoiding School Zones within 30 minutes of school's starting and ending times. Valley Vista will endeavor to operate routes in such a way as to minimize occupant complaints. Said collections will be provided under these terms and based on route maps and Customer Subscription levels.

Exhibit 17 – Contractor Documentation

**Item B.15 - Solid Waste Collection and Facilities Designated by CONTRACTOR
(item D of Exhibit 3A1)**

This item consists of 16 pages (including this page).

Facilities and Solid Waste Facilities

GCR will process all recyclables, bulky items, green waste, and solid waste. All residue materials will be transferred to one of designated solid waste landfills or other Materials Recovery Facility (MRF) listed below.

1. Grand Central Recycling and Transfer Station, (GCR)

(SWISS# 19-AA-1042)

999 South Hatcher Ave. City of Industry, Ca. 91748

General Manager – Mr. Peter Perez Office 626-855-5556

Administrative Assistant – Ms. Alondra Garcia Office 626-855-5626

2. Puente Hills MRF

Sanitation Districts of Los Angeles County Solid Waste Management Department
1955 Workman Mill Rd.

Whittier, Ca. 90607 Contact Mark Revilla

Office 562-699-7411 Ext 1120

3. South Gate LACSD

TBD

PW2	GCR	LACSD - BACKUP	SOUTHGATE
SW COLLECTION RATE	\$ 77.84	\$ 77.84	
ADDITIONAL RECY	\$ 77.84	\$ 77.84	
ORGANICS/GREEN	\$105.00	\$ 112.07	
SINGLE PASS			\$ 105.00
PW3	GCR	LACSD - BACKUP	SOUTHGATE
SW COLLECTION RATE/MIXED WASTE	\$ 77.84	\$ 77.84	
ADDITIONAL RECY	\$ 77.84	\$ 77.84	
ORGANICS/GREEN	\$105.00	\$ 112.07	
SINGLE PASS			\$ 105.00

Electronic waste and recycling materials will be processed through Grand Central Recycling and Transfer Station, to:

E-Recycling of California (Cal EPA# CAL000130029)

7230 Petterson Lane Paramount, Ca. 90723-2022

Contact Maureen Craine

Office 562-634-8372

Fax 562-634-8029

mcraine@erecyclingofcalifornia.com

Recyclables Accepted/Rejected

Grand Central Recycling & Transfer Station,

Accepted

- a. Paper – computer, ledger, wrapping, arts & craft paper, unwanted mail, flyers, telephone books, note cards, newspaper, blueprints, magazines, file folders, paper bags, Post-It notes, catalogues, and all envelopes including those with windows
- b. Cardboard boxes and chipboard – cereal, tissue, dry food, frozen food, shoe, detergent, paper and toilet rolls, and corrugated boxes (broken down and flattened)
- c. Aluminum, tin, metal, and bi-metal cans – (rinsed, if possible) soda, juice, soup, vegetables, pet food, pie tins, clean aluminum foils, empty paint, empty aerosol cans (with plastic caps removed), and wire hangers
- d. Glass bottles and jars – (rinsed, if possible) soda, wine, beer, spaghetti sauce, pickle, and broken bottles/jars
- e. Empty plastic containers, numbers 1 through 5 – (rinsed, if possible) soda, juice, detergent, bleach, shampoo, lotion, mouthwash, dishwashing liquid bottles, milk jugs, tubs for margarine & yogurt, and plastic planters
- f. Lawn clippings, food waste, soiled compostable paper, tree trimmings, branches, brush, and holiday trees

Methodology of Allocating Materials

Valley Vista Services, Inc. shall haul all material collected in the franchise area of Hacienda Heights, to Grand Central Recycling and Transfer Station, , as stated in the original proposal.

Grand Central Recycling and Transfer Station, (GCR) has provided us with the following explanation of waste and recycling allocation. As required by this contract, Valley Vista Services, Inc. does not commingle any materials with any other municipality, agency or jurisdiction. All materials collected are segregated by truck and route, no collected material is commingled with any other collected material.

GCR provides transfer, processing and disposal services to Valley Vista Services, Inc. for all materials collected for the Hacienda Heights franchise community. GCR processes solid waste, commingled recyclables and greenwaste materials collected at the curb for the above stated community. All materials collected are weighed in upon delivery at our certified scales and processed through either the material recovery facility or the transfer station.

Tare Weights

All vehicles utilizing the GCR facility are weighed empty and loaded into the scale software systems so to determine the exact weights of the commodities being delivered. Each vehicle is individually identified by the truck number, route and tare weight.

Solid Waste

Solid Waste materials are first weighed at the certified scales before entering the facility. The exact net weight of the material collected is allocated to the jurisdiction from which the material was collected from. The municipal solid waste collected is then unloaded on the transfer floor and prepared for transfer to local landfills. GCR then allocates the tare weight of each vehicle to the final disposal facility. On a monthly basis, GCR will reconcile each load with weight records and allocations to local landfills.

Greenwaste

Greenwaste materials are handled in the same manner as solid waste is handled in that all weights are carefully tracked from the certified scales through final point of disposal. Each load of waste delivered is carefully allocated based upon tare weights on tons delivered.

Commingled Recyclables

Per the requirements of our contract with Valley Vista Services, Inc. GCR has conducted a waste characterization audit of the commingled blue cart recyclables delivered to GCR from Valley Vista Services, Inc. vehicles servicing the Hacienda Heights Community. This characterization provides for the allocation of each and all materials by weight. Each commodity collected in the collection process is segregated by weight and material classification. The waste characterization process is conducted on a random load of materials delivered from the appropriated jurisdiction, no two jurisdiction have the same waste characterization.

Each commingled vehicle is weighed at the certified scales and a tare weight is captured. The materials are then delivered to the processing area where all materials are sorted and processed for optimum diversion. GCR reconciles the post process by weighing all materials recovered. Each outbound commodity weight is collected and reconciled with the waste characterization for the facility. All residue materials are carefully tracked based upon the waste characterization and allocated to the appropriate jurisdiction.

Reporting

GCR is responsible for allocating all materials processed to the exact pound. All records are reconciled on a monthly basis based upon tare weights delivered, waste characterizations and final disposal weights. GCR reports the weight of each jurisdiction back to Valley Vista Services, Inc. and the County of Los Angeles Sanitation Districts, all recovered commodities are also reported back to Valley Vista Services, Inc..

Miscellaneous Materials

Bulky items/Self Haul

GCR also records all bulky items delivered, recovered via Valley Vista Services, Inc. and self-haul. In addition to Valley Vista Services, Inc. private citizens, gardeners and haulers deliver a significant amount of materials to GCR. GCR reports all materials based upon the jurisdiction of generation. All materials recovered are allocated based upon weight and jurisdiction of generation.

**SAMPLE INVOICE - RECYCLABLES - GRAND CENTRAL
RECYCLING**

01/09/2008 WED 9:03 AM 626835057

01/07/08

RpCsr.rpt Page 1 of 1
 Customer: BURRTEC 12/2008
 Site ID: All 9:05AM
User ID: PHIBERPEREZ

Grand Central Recycling & Transfer Station
Customer Report
 Transactions From 12/01/2007 through 12/31/2007
 Inbound and Outbound Tickets
 Third Party and Intercompany Customers
 Recycle and Disposal Material
 Full Details

Ticket	Date	Trck	In / Out	Yards	Units	Tons	Estimated Tons	Tax
BURRTEC - BURRTEC WASTE INDUSTRIES								
607779	12/10/07	B4928	I	0.00	0.00	2.91	0.00	
611045	12/21/07	B2734	I	0.00	0.00	6.74	0.00	
611054	12/21/07	B4623	I	0.00	0.00	3.65	0.00	
611067	12/21/07	B2258	I	0.00	0.00	9.66	0.00	
BURRTEC - BURRTEC WASTE INDUSTRIES				0.00	0.00	24.96	0.00	
<i># tickets and # transactions</i>								
Report Grand Totals				0.00	0.00	24.96	0.00	
<i># tickets and # transactions</i>								

**SAMPLE INVOICE – REFUSE/RESIDUALS – EL
SOBRANTE LANDFILL**



TRK 600 min

**Riverside County
Waste Management Department**

03174024

14310 FREDERICK STREET, MORENO VALLEY, CA 92553

WASTE DISPOSAL OFFICIAL RECEIPT

FOR CREDIT, ACCOUNTING INFO
AND DISPOSAL SITE OPERATION
PHONE 1-951-486-3200

GSA: 24-CW	Site #: 08 EL SOBRANTE	Trans #: 089803	07:51:14	3/4/2010
Customer: 4370	WMIE/GRAND CNTRL RECYC & TRANS STATION		Gross:	39.39 S
Hauler: 4370	WMIE/GRAND CNTRL RECYC & TRANS STATION		Tare:	19.95 F
Vehicle ID: 5986	Badge #: 011279		Net:	19.44
Vehicle Type: 19	Jcode: 370			
Refuse Type: 09 MISCELLANEOUS ROUTINE REFUSE	19.44 Tons at	\$83.00		\$447.12
CUSTOMER COPY			Amt Due:	\$447.12

David,

Please see below for the language LACSD would be comfortable in issuing.

Mark:

Dear Mr. Perez:

This letter will serve as notice that Los Angeles County Sanitation Districts (LACSD) will have sufficient capacity at the Puente Hills Materials Recovery Facility (PHMRF) to provide up to 600 tons per month of source separated organic waste processing. However, without any contractual commitments, LACSD cannot commit to reserving any capacity for Valley Vista Services, Inc. for this "first come first served" tonnage allocation at the PHMRF.

Sincerely,

WASTE DISPOSAL AND PROCESSING AGREEMENT – VALLEY VISTA SERVICES, INC. AND COUNTY SANITATION DISTRICT NO. 2 OF LOS ANGELES COUNTY

This Waste Disposal and Processing Agreement (“**Agreement**”) is dated _____, 2022, and is between VALLEY VISTA SERVICES, INC., a California corporation (“**Company**”) and COUNTY SANITATION DISTRICT NO. 2 OF LOS ANGELES COUNTY, a county sanitation district organized and existing under the provisions of the County Sanitation District Act, Health and Safety Code Section 4700 *et seq.* (the “**District**”). The District and Company are referred to in this Agreement individually as a “**Party**” and collectively as “the **Parties**.” The terms and conditions of this Agreement become effective on October 1, 2022 (the “**Effective Date**”).

The District owns and operates a solid waste recycling and transfer system in the County of Los Angeles, California, that includes the Puente Hills Materials Recovery Facility (“**PHMRF**”), and the South Gate Transfer Station (“**SGTS**”). PHMRF and SGTS are referred to collectively in this Agreement as the “**District’s Facilities**.”

The District has adopted an ordinance known as the *Ordinance Prescribing Fee and Charge Rates for Solid Waste Management Activities at the Puente Hills Materials Recovery Facility (MRF), and the South Gate Transfer Station* (“**Ordinance**”). The Ordinance provides for the District to enter into agreements with customers to accept specific quantities of solid waste at the District’s Facilities on agreed terms and conditions, which may include commitments for delivery of minimum quantities of solid waste. The Ordinance also provides for the District to supply other solid waste management services at the District’s Facilities pursuant to agreements with customers, including the processing of food waste, and to establish fees, rates, and charges applicable to those services.

Company is willing to commit to deliver minimum quantities of solid waste to the District’s Facilities at agreed rates and to agree upon established rates for other solid waste management services. The Parties therefore agree as follows:

1. Definitions

Capitalized terms in this Agreement will have the meanings set forth in this Section 1, or as otherwise defined in this Agreement.

1.1 “**Acceptable Waste**” means waste that meets the following type and source of waste requirements:

a. Types of Waste: The types of waste that the District accepts at the District’s Facilities, including municipal solid and inert waste (“**MSW**”), Greenwaste, and source separated Food Waste. The District may change the types of wastes it accepts at the District’s Facilities at any time and from time to time.

b. Source of Waste: The waste must have been:

(i) Collected by Company in trucks owned or leased by

Company, or received at transfer stations or processing facilities owned by Company and collected or transferred by Company pursuant to franchise agreements or contracts between Company and waste generators; or

(ii) Waste that meets the conditions of Section 1.1.b(i) and is delivered by Company directly to a Third Party Transfer Station that delivers an equivalent amount of waste to the District’s Facilities (“**Third Party Transfer Station Acceptable Waste**”). All references in this Agreement to Monthly Tonnage Commitment and Acceptable Waste include Third Party Transfer Station Acceptable Waste.

1.2 “**Chief Engineer**” means the District’s Chief Engineer and General Manager, or his or her designee who is an employee of the District.

1.3 “**Fees and Taxes**” means any and all federal, state, local or other taxes, assessments, fees, host charges, gross receipts taxes or charges, surcharges, or similar charges directly or indirectly related to the acceptance, processing, storage, burial or disposal of material that are paid by or imposed on the District or the District’s Facilities or operations by law, ordinance, rule, regulation, or agreement with a governmental authority, whether imposed retroactively or prospectively.

1.4 “**Food Waste**” means source-separated food waste that has no more than 3% contamination by weight and is free of excessive amounts of small contamination that makes removal by hand difficult (e.g. oil, grease, bones, packaging, paper, cups, utensils, plastic containers, plastic bags, etc.). Acceptable materials in any quantity include fruits, vegetables, pastas, grains, rice, beans, bread, cheese, pastries and waste meat, eggs, poultry and fish material from residential sources and restaurants. Upon the Chief Engineer’s written approval, and subject to any conditions established by the Chief Engineer, Food Waste specifications may be changed and could also include wet-routed food and organic waste.

1.5 “**Greenwaste**” or “**Green Waste**” means source-separated trimmings from lawns, bushes and trees. The following items may not be in Green Waste loads: manure, palm fronds, limbs or stumps larger than six inches in diameter or eight feet in length, trash, dirt, piping or other items that are not vegetation. The District will not accept as GreenWaste loads that are odorous.

1.6 “**MSW**” means municipal solid and inert waste.

1.7 “**MSW Transfer**” means MSW received by the District that will be transferred offsite and may or may not include additional processing for diversion, at the District’s sole discretion.

1.8 “**Orange County Differential Fee**” means the additional transportation fee and landfill tipping fee that the District has to pay at Orange County landfills for the disposal of waste that originates in Orange County relative to the tipping fee for waste that originates outside of Orange County. The initial Orange County Differential Fee is \$15.05 per ton.

1.9 “**Third Party Transfer Station**” is a transfer station that is not owned or operated by Company.

1.10 “**Tipping Fee**” or “**Tipping Fees**” are the amounts payable to the District for each load of Acceptable Waste delivered to the District’s Facilities. Term This Agreement will become effective on October 1, 2022 and will expire at 11:59 p.m. on December 31, 2027, unless terminated sooner under the provisions of Section 10. The requirements for the Company to deliver and pay for Shortfall Tonnage will terminate on June 30, 2028.

3. Minimum Tonnage Commitment

3.1 During each calendar month of this Agreement, Company shall deliver to the District’s Facilities at least the number of tons of Acceptable Waste that is equal to the MonthlyTonnage Commitment, defined below.

3.2 The Company’s “**Monthly Tonnage Commitment**” is 1,000 tons per month minimum (Tier 2, as shown on the attached Table 1) including MSW, Green waste and Food Waste . The District shall reserve capacity at the District’s Facilities to accept at least the amount of the Monthly Tonnage Commitment from the Company each month.

a. Voluntary Increases. The Company may increase the Monthly Tonnage Commitment at any time by written notice to the District, which increase will become effective in the calendar month in which the notice is received by the District, and will continue in effect for the remainder of the term of this Agreement.

b. Decreases. The Chief Engineer shall prospectively reduce the Company's Monthly Tonnage Commitment following a written request by the Company based on the following conditions only in addition to other provisions of this Agreement:

(i) If the District stops accepting any type of waste that was previously Acceptable Waste that Company delivered to the District's Facilities, then the District will proportionately reduce the Company's Monthly Tonnage Commitment; or

(ii) A verifiable loss of tonnage due to a franchise or licensing action by a public agency through no fault of Company.

3.3 If Company fails to deliver the Monthly Tonnage Commitment during any calendar month (a "**Shortfall**"), subject to Company's right to make up Shortfall as described in the following sentence, Company shall be liable to the District for the Tipping Fee on the difference between the Monthly Tonnage Commitment and the actual tonnage delivered by Company (the difference, the "**Shortfall Tonnage**"). During the six calendar months following a Shortfall, Company may make up the Shortfall by delivering Acceptable Waste in the Shortfall Tonnage amount to the District's Facilities in addition to the Monthly Tonnage Commitment. To the extent that Company fails to make up the Shortfall Tonnage during the following six months the District shall add the Company's liability for the Shortfall to Company's regular monthly notice of charges as a separate item. The amount of the Company's liability will be the remaining tons of Shortfall multiplied by the Company's Tier rate for MSW Transfer at PHMRF for the month in which the Shortfall occurred. After December 31, 2027, the amount of the Company's liability will be the remaining tons of Shortfall multiplied by the posted Gate Rate for MSW at the PHMRF.

3.4 No Brokering. The Monthly Tonnage Commitment may only be met through Company's own collected Acceptable Waste. Company shall not include, and the District will not accept, as any part of the Company's Monthly Tonnage Commitment any waste collected by third party hauling companies. The Company shall pay the applicable posted Gate Rate for any third party hauling company-collected waste that the Company delivers to the District's Facilities.

4. Tipping Fees and Rate Discounts

4.1 Tipping Fee. The Company shall pay a Tipping Fee to the District for each load of Acceptable Waste that Company delivers to the District's Facilities.

4.2 Gate Rate; Volume Discount Rates. For MSW Transfer and Greenwaste, the District has established a general rate known as the "**Gate Rate**" for each waste type that includes all Fees and Taxes. In exchange for the delivery of the guaranteed Monthly Tonnage Commitment, the District will discount the Company's per-ton Tipping Fee rates as set forth in the attached Table 1, and as further described below. If there is any conflict between the language in the sections below and Table 1, Table 1 will govern.

a. MSW Transfer. The Company's MSW Transfer Tipping Fee rate will be the Gate Rate reduced by the applicable discount factor for the Company's Monthly Tonnage Commitment. Discount factors for MSW Transfer are shown in Table 1. For waste originating in Orange County, the Tipping Fees for MSW Transfer are the rates in Table 1 plus the Orange County Differential Fee.

b. Food Waste. The initial Tipping Fee rate for source-separated Food Waste is \$10.00 per ton less than the posted Gate Rate for Food Waste at the PHMRF. Unacceptable Food Waste will be charged the applicable per-ton MSW Transfer Tipping Fee rate and may qualify to be partially diverted depending on the quality of the load.

c. Greenwaste. The Tipping Fee rate for Greenwaste will be the posted Gate Rate for Greenwaste at the District's Facilities. Unacceptable Greenwaste will be charged the applicable per-ton MSW Transfer Tipping Fee rate and may qualify to be partially diverted depending on the quality of the load.

4.3 Tipping Fees for Tonnages in Excess of Monthly Tonnage Commitment.

If the Company delivers tonnage in excess of the upper tonnage limit of the Tier associated with its Monthly Tonnage Commitment, then the Company will be billed by the District at Tipping Fee rates associated with the next Tier for the total actual monthly tons delivered, with the condition that the Company can only qualify for Tipping Fees rates corresponding to the next higher Tier above its committed Tier. However, if the Company delivers tonnage to the District's Facilities in excess of the upper tonnage limit of the Tier associated with its Monthly Tonnage Commitment for a period of six consecutive months, then beginning in the seventh month, the Company will no longer qualify for the Tipping Fees associated with the higher Tier unless the Company increases its Monthly Tonnage Commitment to the higher Tier by providing the District with written notice pursuant to Section 3.2.a.

4.4 Examples.

a. Example 1 – Within Tier: If the Company has a Tier 2 commitment (1,000-2,000 tons per month) and delivers 1,500 tons in July 2024, then the District will charge, and the Company shall pay Tier 2 Tipping Fees for all tonnage delivered in July 2024.

b. Example 2 – Exceeds Tier for Less Than Six Months: If the Company has a Tier 2 commitment and delivers 7,500 tons in July 2024 through November 2024 and 1,500 tons in December 2024, then the Company will be charged Tier 3 Tipping Fees for all tonnage delivered in July 2024 through November 2024 and Tier 2 rates for all tonnage delivered in December 2024.

c. Example 3 – Exceeds Tier for Longer Than Six Months: If the Company has a Tier 2 commitment and delivers 7,500 tons in July 2024 through January 2025, then the Company will be charged Tier 3 Tipping Fees for all tonnage delivered in July 2024 through December 2024 and Tier 2 rates for all tonnage delivered in January 2025 unless the Company increases its Monthly Tonnage Commitment to a Tier 6 level.

4.5 Changes to Gate Rates.

a. The District may adjust the Gate Rates from time to time at its sole discretion. The Gate Rates are established by the District by or pursuant to the Ordinance.

b. The Gate Rate is composed of a base rate and Fees and Taxes (defined below).

c. The Parties acknowledge that solid waste disposal is a highly regulated and highly-taxed enterprise. From time to time, state, federal, and local governments impose new Fees and Taxes or increase existing Fees and Taxes on the District's operation of the District's Facilities. In addition, changes in laws and regulations may require additional investment of capital and may cause the District's costs of operations to increase. If new or increased Fees and Taxes or additional regulatory compliance costs are imposed, assessed, levied on, or charged to the District, or if increased operational costs result from changes in regulations, permit conditions or regulatory interpretation, the District will adjust the applicable Gate Rate

and Tipping Fee rates so that all such new or increased Fees and Taxes and cost increases are passed through to Company.

d. Beginning on July 1, 2023 and each July 1 thereafter, the District shall adjust the Orange County Differential Fee by the amount of any annual percent increase in the April to April Consumer Price Index for All Urban Consumers for Los Angeles-Long Beach-Anaheim.

e. At least 30 days before any increase in any Tipping Fee rates for MSW Transfer, Food Waste, or Greenwaste, the District shall notify Company of the District's new rates, and the District shall include with the notice a description of how the new rates were calculated pursuant to this Agreement.

5. Use of District's Facilities

5.1 PHMRF is currently open to receive waste and recyclables from 4:00 a.m. to 5:00 p.m., Monday through Saturday. Monday through Friday and 6:00 a.m. to 1:30 p.m. on Saturday. SGTS is currently open to receive waste from 6:00 a.m. to 5:00 p.m., Monday through Saturday.

5.2 The District may change the hours of operation for the District's Facilities at any time and for any reason. The District shall give Company reasonable notice of any change to the hours of operation. The Monthly Tonnage Commitment will be proportionately reduced if there is any change in those hours of operation that materially affects Company's ability to meet the Monthly Tonnage Commitment. The District's Facilities will be closed on Sundays and on New Year's Day, Memorial Day, July 4th, Labor Day, Thanksgiving and Christmas Day. The District shall give the Company reasonable notice of any other closures; however, so long as any one of the District's Facilities is open, the Company's Monthly Tonnage Commitment will not be reduced.

6. Rejection of Waste

6.1 The District shall conditionally accept each load of Acceptable Waste delivered by Company's vehicles to the District's Facilities, but may, by written notice to Company, revoke its acceptance if the District determines that any waste delivered by Company either is not acceptable for receipt at the District's Facilities, or constitutes Unacceptable Waste as defined below (collectively "**Rejected Waste**"). The District's initial acceptance of Rejected Waste at the District's Facilities will not transfer ownership of the Rejected Waste to the District but merely creates a bailment, and the District's revocation of acceptance of the Rejected Waste will operate to immediately transfer the risk of loss and responsibility for proper disposal of the Rejected Waste to Company.

6.2 "**Unacceptable Waste**" means any waste that:

- a. If disposed of at the District's Facilities would violate any applicable law or any District permit condition;
- b. Is a hazardous waste or a hazardous substance as those terms are defined under applicable law;
- c. Is a designated waste or Class II waste under applicable law; or
- d. Has or may have constituents or components not specifically identified in any waste material profile or similar document and which, in judgment of the Chief Engineer increases the nature or extent of the hazard and risk of handling or disposing of the waste materials, but only if that judgment is consistently applied to all waste delivered to the District's Facilities.

6.3 Within 48 hours after receiving written notification from the District that

identified wastes delivered to the District's Facilities by Company are Rejected Waste ("Rejection Notice"), Company shall (1) promptly re-take (or arrange to re-take) possession of the Rejected Waste or (2) make arrangements satisfactory to the District for the removal of the Rejected Waste from the District's Facilities. If Company fails to take possession of the Rejected Waste or make suitable arrangements satisfactory to the District within 48 hours of the Rejection Notice, the District may arrange for the removal of the Rejected Waste from the District's Facilities and for its transportation and disposal at a facility permitted to accept the Rejected Waste in accordance with applicable law and Company shall promptly reimburse the District for all of the District's costs and expenses incurred by the District in testing, clean-up (including remediation-related costs and expenses), handling, loading, preparing, transporting, storing, disposing, and returning the Rejected Waste to Company or transporting Rejected Waste to an alternative disposal facility upon the District's presentation of a notice of charges for such costs to Company.

7. Contamination

7.1 Food Waste must not have more than 3% contamination by weight.

Greenwaste must not have more than 1% contamination by weight, which has been the standard for Greenwaste acceptance at the District's Facilities since November 1, 2013. Company's drivers will have the opportunity to clean up loads of Greenwaste and to put contamination back into their trucks as long as this effort can be conducted in a safe manner and does not unreasonably interfere with the operations of the District's Facilities. "**Contamination**" means anything that is not the primary commodity in each truckload of source-separated material delivered to the District's Facilities. Company shall not deliver any loads that contain any contamination that would impede the District's ability to receive, process, store, or sell the materials (e.g. the material creates excessive odors, attracts flies, etc.).

7.2 If the Chief Engineer determines that a load of source-separated materials is contaminated, then the Chief Engineer and Company shall negotiate in good faith to agree upon a price that is mutually acceptable for that load. Company shall use commercially reasonable efforts to have the generator of the material reduce the amount of contamination to a level acceptable to the District. If Company is unable to consistently provide loads that have an acceptable level of contamination from any particular generator, the Chief Engineer and Company shall negotiate in good faith to attempt to reach an agreement agree on a mutually acceptable new price for the more-contaminated commodity.

8. Notice of Charges

8.1 The District shall give notice of charges to Company each month for all tons of Acceptable Waste delivered to the District's Facilities by Company during the preceding calendar month. Company shall pay all undisputed charges within 15 days after receipt of notice of charges.

8.2 Charges become delinquent 45 days after the date of the notice of charges.

The District shall impose a service charge of 10% of the delinquent balance not paid within 75 days. If Company does not pay the account balance within 105 days, the District shall charge interest on the total of the unpaid balance and any service charges at the rate of 0.5% per month. If Company has an unpaid balance for 105 days, the District may suspend Company's access to all solid waste facilities operated by the District until Company's account balance is paid in full. Suspension of Company's access to the District's solid waste facilities as a result of Company's uncured breach of this Agreement will not affect Company's obligation to meet its Monthly Tonnage Commitment.

8.3 If Company disputes the amount of any charges, Company shall give the District written notice of the dispute within 20 days after Company receives the notice of charges that contains the disputed charge. In the written notice of dispute, Company shall state the basis for the disputed amount with sufficient specificity to allow the District to investigate Company's claim. If Company fails to dispute a notice of charges within 20 days after the date of the notice of charges, Company will be conclusively presumed to have waived its right to dispute the amount of the notice of charges. Tonnage amounts of Acceptable Waste used for billing will be determined using the District's weigh scales at the District's Facilities at the time Company delivers each load of Acceptable Waste.

8.4 If Company uses or seeks to use the District's Solid Waste Disposal Credit Account system, then Company shall complete the District's Solid Waste Disposal Credit Application and comply with all the District's terms and conditions related to that application, except that timing for interest and service charges for the District's Facilities (only as defined in this Agreement) will be governed by the terms of this Agreement. The security deposit and all other requirements of the Solid Waste Disposal Credit Application will remain requirements of maintaining a credit account with the District.

8.5 Company may pay monthly invoices with a bank credit card. For credit card payments, a convenience fee will be charged in addition to the invoiced amount.

8.6 Company shall not deliver any waste to the District's Facilities that is defined as Unacceptable Waste under this Agreement. Only Acceptable Waste may be delivered to the District's Facilities under this Agreement. Company shall maintain commercially reasonable records and supporting source documents evidencing the origin of all waste delivered to the District's Facilities for a minimum of five years. The District may, through its duly authorized agents or representatives, examine and audit records and supporting source documents maintained by Company concerning the origin of waste delivered to the District's Facilities at any and all reasonable times after 30 days written notice for determining the accuracy of those records and of the reports provided to the District pursuant to this Agreement. The full cost of the audit, as determined by the District, must be paid by Company if any of the following conditions exist:

- a. The audit reveals that the Company engaged in deliberate brokering or knowingly delivered Unacceptable Waste; or
- b. Company has failed to maintain true and complete books, records, accounts, and supporting source documents substantially in accordance with this Section 8.6. Otherwise the District shall bear the cost of the audit.

9. Indemnity

9.1 Company shall indemnify, defend, and hold harmless the District, its directors, officers, employees, agents, successors and assigns, and each of the other County Sanitation Districts of Los Angeles County, and their directors, officers, employees, agents successors and assigns, from and against any and all claims, actions, liabilities, damages, losses, costs, and expenses (including court costs and reasonable attorneys' fees and expenses), arising out of or in any way related to: (a) Company's performance of its obligations under this Agreement; (b) Company's use of the District's Facilities or areas adjacent or appurtenant to the District's Facilities; (c) the assertion by any third party of ownership of or any rights or interests in any waste or waste material accepted for disposal by the District; (d) any bodily injury, personal injury, or property damage caused by or resulting from any acts or omissions of

Company; (e) delivery of waste that is not Acceptable Waste to the District's Facilities; (f) processing, transporting, or disposal of Rejected Waste; and (g) any violation by Company of applicable law.

9.2 The District shall indemnify, defend, and hold harmless Company, its directors, officers, employees, agents, successors and assigns, from and against any and all claims, actions, liabilities, damages, losses, costs, and expenses (including court costs and reasonable attorney's fees and expenses) arising out of: (a) the District's performance of its obligations under this Agreement; (b) any bodily injury, personal injury, or property damage solely caused by or solely resulting from acts or omissions of the District; and (c) any violation by the District of applicable law.

9.3 The Parties indemnity obligations will survive the expiration or earlier termination of this Agreement.

10. Termination and Default

10.1 The terms "**Default**" or "**Event of Default**" mean the failure of a Party to observe or perform any covenant, condition, or term of this Agreement.

10.2 Upon the occurrence of any other Event of Default by either Party, the non-defaulting Party may: (i) seek equitable relief from a Court of appropriate jurisdiction; or (ii) if the Event of Default continues for thirty days after notice of the Event of Default is provided to the other party, terminate this Agreement and have recourse to any other right or remedy to which that Party may be entitled by law or in equity, including, but not limited to, the right to recover for all damage or loss suffered as a result of the Event of Default.

10.3 If disposal at the Brea Olinda Landfill becomes unavailable to the District before December 31, 2025, the Gate Rate will be adjusted to identify the most cost-effective transportation and disposal option. If the amount of the Gate Rate adjustment exceeds 10% because of the unavailability of disposal at the Brea Olinda Landfill, this Agreement will be reopened for renegotiation. If the Parties cannot come to an agreement within 45 days after Brea Olinda Landfill becomes unavailable to the District, then this Agreement will terminate. Company's obligations to pay for Waste that has already been delivered shall survive any such termination.

11. Miscellaneous

11.1 *Assignment*. A Party shall not sell, assign, or otherwise transfer, by operation of law or otherwise, its rights or obligations under this Agreement, in whole or in part, without the prior written consent of the other Party.

11.2 *Independent Contractor*. Each Party is and will perform this Agreement as an independent contractor and, as such, will have and maintain complete control over all of its employees, agents and their conduct. Neither Party, nor anyone employed by it will be, represent, act, purport to act or be deemed to be the agent, representative or employee of the other Party.

11.3 *Waste Characterizations*. Upon request of Company, the District will perform up to five additional waste characterizations per year at a cost of \$500 per characterization for waste delivered to the PHMRF which amount will be added to the bill for the month wherein the waste characterization takes place. The Parties shall coordinate the dates and times of the characterizations in order to minimize operational impacts to the PHMRF.

11.4 *Tours*. The District shall accommodate reasonable requests by Company to provide tours of the District's Facilities to Company and Company's current or potential clients.

11.5 *Reporting.* The Company's deadline for reporting jurisdiction of origin for the preceding calendar month for MSW Transfer, Greenwaste and Food Waste transactions shall be by no later than the fifth calendar day of each calendar month.

11.6 *Entire Agreement.* This Agreement represents the entire understanding and agreement between the Parties relating to the transportation, storage, treatment, processing and disposal of the waste materials described in this Agreement and supersedes any and all prior agreements, whether written or oral, that may exist between the Parties regarding Company's disposal of waste at the District's Facilities, except that the Company shall also comply with all Solid Waste Disposal Credit Account requirements as described in Section 8.4. The Company shall comply with all ordinances adopted by the District's Board of Directors and all applicable regulations, laws, and site rules at the District's Facilities.

11.7 *Notices.* All notices or other communications to be given under this Agreement must be in writing and will be deemed given when mailed by United States mail, or by nationally-recognized overnight courier or acceptable electronic communication with proof of delivery:

Exhibit 17 – Contractor Documentation

Item B.16 - Additional CONTRACTOR Commitments

This item consists of 2 pages (including this page).

Valley Vista Services has not made any additional contractor commitments.

Exhibit 17 – Contractor Documentation

Item B.17 - Transition Roll-Out Plan

This item consists of 2 pages (including this page).

- **Ordering Vehicles and/or containers:** Valley Vista currently has a sufficient number of vehicles to begin collections, with an additional amount of new vehicles on order and scheduled for a December 2022' delivery (see attached order). Containers of sufficient sizes and quantities have been ordered (see attached orders) to provide adequate inventory for the transition as well as maintenance and service changes.
- **Vehicle and/or Container delivery from manufacturer:** As stated, Valley Vista has a sufficient number of late model collection vehicles to begin collections (see Vehicle List) as well as having additional collection vehicles on order for a December 2022' delivery (see Vehicle Order). Containers are currently being delivered with all required inventory being at our yard by Sept 1st, 2022. (see attached photos)
- **Container Assembly:** Containers are assembled as they arrive at our facility and made ready for delivery to customers. All containers will be assembled and ready for delivery by September 1st, 2022.
- **Distributing Containers to Customers and Occupants:** Containers will be delivered utilizing our fleet of flat bed and bin delivery vehicles utilizing Valley Vista employees. Delivery could begin as soon as September 1st 2022, and continue through December 23rd, 2022' or sooner. Customers will receive The same level of service that currently exists based on information we have received from the LADPW, their current hauler, and our own route audit, along with a 65 gallon organics cart as the default organics service level. All service level changes/adjustments will be made after customer contact and in-field outreach.
- **Public Outreach and Education Activities:** Upon award of contract and receipt of Letter from Director, Valley Vista will print and mail said letter First Class via USPS. Within two weeks of mailing Letter from Director, Valley Vista will print and mail approved, Letter from Contractor, Subscription Order Form, Description of the LA County Exclusive Commercial Franchise System, Customer Bill of Rights and Responsibilities, Newsletter, Instructions regarding compliance with the Mandatory Commercial Organics Recycling and Mandatory Commercial Organics Recycling laws, Training document on how to properly sort Organic Waste, and LA County's Food DROP Program information.

Exhibit 17 – Contractor Documentation

Item B.18 - Difficult to Service Occupants (Item L of Exhibit 3A1)

This item consists of 2 pages (including this page).

Valley Vista will work with customers that are in Hard to Service areas to adjust services to utilize scout services where necessary or when not practical to provide manual or semi-automated services utilizing smaller sized and lighter vehicles and equipment including dual stream collection vehicles when necessary.

Valley Vista will submit to the Director requests to change service methods when conventional collection is not possible, for approval.

Exhibit 17 – Contractor Documentation

Item B.19 - Alternative Container Sizes (Item C14 of Exhibit 3A1)

This item consists of 2 pages (including this page).

Valley Vista will work with customers that require alternative container sizes to accommodate the required collection services. Based upon the customers capacity needs and the requirements of the applicable laws and regulations

Exhibit 17 – Contractor Documentation

Item B.20 - Movement of Green Waste

This item consists of 3 pages (including this page).

Valley Vista will comply with all Applicable Laws regarding the transportation of Green Waste, including the CDFA's regulations that quarantine certain types of Green Waste and restrict its movement.



COMPLIANCE AGREEMENT for the use with MASTER PERMIT QC 1289/1290/1291/1292/1337
[Pursuant to California Code of Regulations 3154 and Applicable CCRs Checked Below]

Provisions for the Intrastate Movement of GREEN WASTE
Originating within the State Interior Quarantine for (check all that apply):

- Asian Citrus Psyllid (CCR 3435)
- Huanglongbing (CCR 3439)
- Oak Mortality Disease Control/*Phytophthora ramorum* (CCR 3700)
- European Grapevine Moth (CCR 3437)
- Light Brown Apple Moth (CCR 3434)

Compliance Agreement No: 19-GW-0005

1. PROGRAM

The California Department of Food and Agriculture (CDFA), and the Los Angeles County Agricultural Commissioner cooperating as the Program.

PROGRAM INFORMATION

Los Angeles County Agricultural Commissioner's Office

Street Address: 12300 Lower Azusa Road

City: Arcadia Zip Code: 91006

Program Officer: _____

Phone (626) 575 - 5471 Fax (_____) _____

Email _____

2. BUSINESS/ESTABLISHMENT:

Establishment Name (subsequently referred to as "Establishment"):

VALLEY VISTA SERVICES INC.

ESTABLISHMENT INFORMATION

Owner Name DAVID M. PEREZ - SECRETARY

Manager Name DAVID M. PEREZ

Phone (626) 961 - 6291 Fax (626) 581 - 7615

Email DAVIDPEREZ@ZEREPMANAGEMENT.COM

Mailing Address: 17445 E. RAILROAD STREET

City: CITY OF INDUSTRY Zip Code: 91748

(check box if physical address is the same as mailing address)

Physical Address: _____

City: _____ Zip Code: _____

Thos Bros _____ X St _____

GPS _____

Exhibit 17 – Contractor Documentation

Item B.21 - Contamination Monitoring Plan

This item consists of 3 pages (including this page).

In order to maintain a successful program and encourage informed participation VVS will use "**Physical Container Inspections**" in order to control contamination or the recyclable streams. Utilizing VVS' on board computer systems the route driver will perform lid flip inspections. Upon detection of improperly disposed of materials in the organics stream, the driver will take a photo that will be automatically uploaded to the customer file for reference and place a courtesy collection notice on the cart advising of the issue and possible future remedial measures. The customer will then be flagged for further monitoring. A contamination report will be sent to the Customer Service manager and if necessary, the customer will be contacted and advised. If contamination persists a letter will be sent along with educational material and request for a site visit by our VVS Green Team.

The Recycling containers shall be considered contaminated if it contains more than percent (15 %) Non-Recyclable material by weight or volume. The Organic Waste containers shall be considered contaminated if it contains more than percent (20 %) Non-Organic Waste material by weight or volume.

Actions following contamination monitoring must be approved by the County and shall include but not limited to the following:

Upon finding Container Contaminants, Valley Vista shall warn customers who have placed materials into any container that is not the type of material for which the container is designated such as Organic Waste in the Recycling container, Recyclables in the Organic Waste container, or Organic Waste and/or Recyclables in the Refuse containers as required by CalRecycle under SB 1383.

- 1st Incident- Upon finding Container Contaminants, Valley Vista shall photograph and provide written notice to the customer. Written notice shall include information regarding properly separating materials and may be left on the container, at the door, and/or notice may be mailed, emailed, or electronically messaged so that customer receives the notice prior to the next Collection. The format of the contamination notice must be approved by the County.
- 2nd Incident- If second incident is observed, Valley Vista shall photograph and provide written notice to the customer and provide a warning to the customer that they will be charged a contamination fee if no compliance is attained by next collection day.

- 3rd Incident - If third incident is observed, Valley Vista shall photograph, provide a written notice, and shall collect the contaminated container and may charge the customer a contamination fee. If the Contractor intends to execute any of the following: Non-collection, extra fees or charges, and any recommended actions must be approved by the County before implementing. Photographic evidence must be provided to the County for justification.

Disposal of Contaminated Materials

- If Valley Vista observes Container Contaminants in a customer's Container(s), Valley Vista may dispose of the container's contents, provided Valley Vista complies with the noticing requirements set forth above. Valley Vista shall report the total number of containers disposed of due to observation of Container Contaminant

Exhibit 17 – Contractor Documentation

Item B.22 - Procurement of Recovered Organic Waste Products (Item J4 of Exhibit 3A1)

This item consists of 2 pages (including this page).

VVS procures RNG through a wheeling agreement with Clean Energy Fuels, delivered through our CNG fueling system. Valley Vista also procures compost and soil amendments from its composting programs to distribute through its Compost Giveaway Programs. Valley Vista will assist the County in meeting the procurement obligations.

VVS will deliver the equivalent in tons to 25% of our total fuel usage for the LA County Franchise area(s) fleet, which is estimated to be 1,231 tons of compost and 714 tons of mulch per year at no cost, to LA County Parks and Recreation sites or LA County Road Department sites as directed by LADPW. All material will be of sufficient quality and sourcing so that it complies with the requirements of SB 1383.

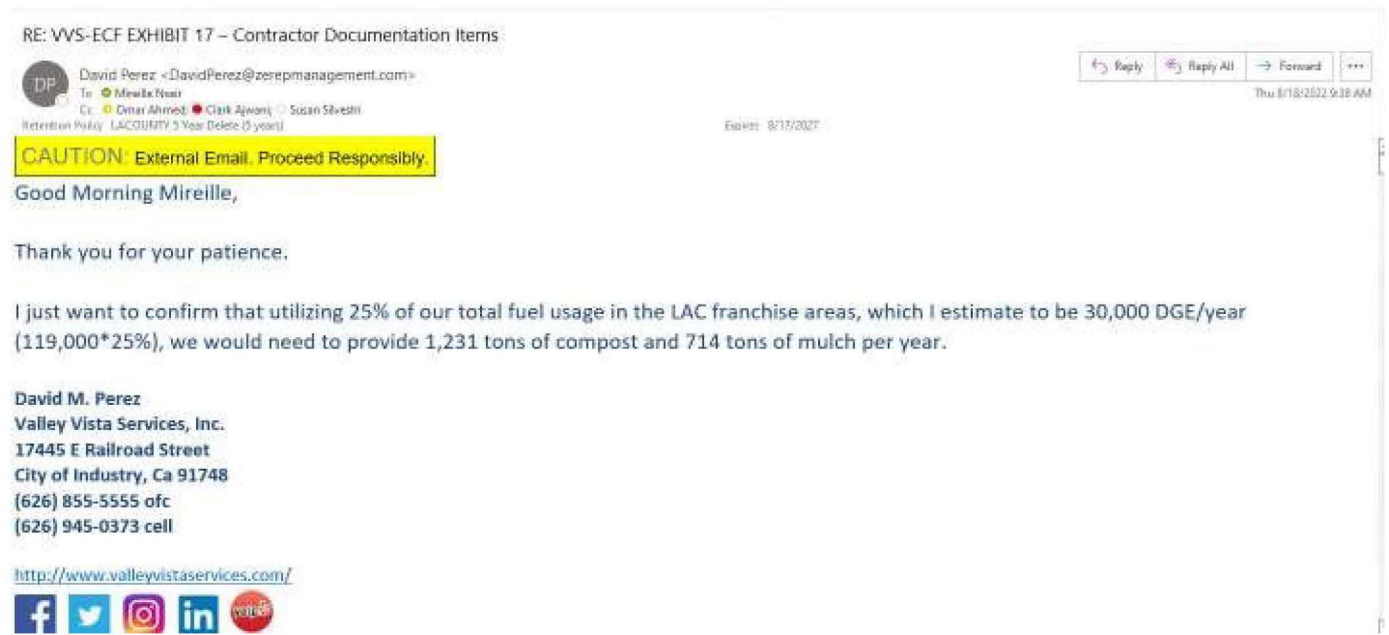

P:\aepub\Service Contracts\CONTRACT\David\FRANCHISE-COMMERCIAL\2020-2021\Exclusive Commercial Franchise\Contract\Valley Vista Services\San Gabriel Valley East\08 Exclusive Commercial Franchise Exhibits 8_16_22 (For VVS Final) Clean Copy.docx