

County of Los Angeles Department of Public Works

Low Impact Development



Standards Manual
February 2014



Table of Contents

Section 1. Introduction 1-1

 1.1. Purpose and Goals 1-1

 1.2. Organization of LID Standards Manual 1-2

 1.3. Environmental Background 1-2

 1.4. Low Impact Development Strategies and Goals 1-5

 1.5. Regulatory Background..... 1-6

 1.6. Applicability of the LID Standards Manual..... 1-8

 1.7. Project Plan Submittals 1-9

Section 2. Designated Project Requirements..... 2-1

 2.1. Introduction 2-1

 2.2. Stormwater Management Requirements for Designated Projects..... 2-2

Section 3. Non-Designated Project Requirements 3-1

 3.1. Introduction 3-1

 3.2. Stormwater Management Requirements for Small-Scale Non-Designated
 Projects..... 3-3

 3.3. Stormwater Management Requirements for Large-Scale Non-Designated
 Projects..... 3-4

Section 4. Site Assessment and Design Considerations..... 4-1

 4.1. Assessing Site Conditions and Other Constraints..... 4-1

 4.2. Site Design Principles 4-6

Section 5. Source Control Measures..... 5-1

 5.1. Introduction 5-1

 5.2. Descriptions 5-1

Section 6. Stormwater Quality Design Volume Calculation 6-1

 6.1. Introduction 6-1

 6.2. Stormwater Quality Design Volume (SWQDv) 6-1

 6.3. HydroCalc Program..... 6-3

Section 7. Stormwater Quality Control Measures..... 7-1

 7.1. Introduction 7-1

 7.2. Stormwater Quality Control Measures 7-1

 7.3. Technical Infeasibility 7-6

 7.4. Alternative Compliance 7-7

Section 8. Hydromodification Requirements 8-1

8.1. Introduction 8-1

8.2. Exemptions to Hydromodification Requirements..... 8-1

8.3. Frequency Analyses..... 8-1

8.4. Sediment Analysis..... 8-2

8.5. Infeasibility of Hydromodification Implementation 8-2

Section 9. Stormwater Quality Control Measure Maintenance 9-1

9.1. Maintenance Plan Requirements 9-1

9.2. Maintenance Agreement 9-4

List of Figures

Figure 1-1. Pre- vs. Post-Project Hydrograph (Modified from Haltiner, 2006) 1-4

Figure 1-2. Hydrograph with Conventional Best Management Practices (Modified from Haltiner, 2006)..... 1-4

Figure 1-3. Goal of Low Impact Development is to Mimic the Pre-Project Hydrograph through Reduction in Peak Runoff Volume and Flow (Modified from Haltiner, 2006)..... 1-5

Figure 2-1. Design Process for Meeting Stormwater Requirements for Designated Projects 2-3

Figure 3-1. Design Process for Meeting Stormwater Requirements for Non-Designated Projects 3-2

Figure 7-1. Alternative Compliance Measures for Designated Projects 7-9

List of Tables

Table 4-1. Typical Space Requirements for Stormwater Quality Control Measures.... 4-7

Table 5-1. Source Control Measures Selection Matrix 5-2

Table 7-1. General Guidelines for Stormwater Quality Control Measures..... 7-4

Table 7-2. Water Quality Benchmarks Applicable to Stormwater Runoff Conveyed to Off-Site Mitigation Sites 7-14

Table 7-3. Typical Pollutants of Concern by Land Use..... 7-15

List of Appendices

Appendix A: Effective TMDLs for Water Bodies in Los Angeles County (October 2013)

Appendix B: Tier 3 Pollutants of Concern

Appendix C: Geotechnical Information and References

Appendix D: Source Control Measure Fact Sheets

Appendix E: Stormwater Quality Control Measure Fact Sheets

Appendix F: Stormwater Quality Control Measure Examples

Appendix G: Drainage Acceptance Letter and Owner Certification Statement Example

Appendix H: Example Maintenance Agreements

Appendix I: References

List of Acronyms

ASTM	American Society for Testing and Materials
BMP	Best Management Practice
CEQA	California Environmental Quality Act
CFR	Code of Federal Regulations
cfs	Cubic feet per second
CWA	Clean Water Act (Federal Water Pollution Control Act)
EMC	Event mean concentration
GMED	Geotechnical and Materials Engineering Division
LACDPW	Los Angeles County Department of Public Works
LDD	Land Development Division
LID	Low Impact Development
LUST	Leaking Underground Storage Tank
MEP	Maximum extent practicable
MODRAT	Modified Rational Method
MS4	Municipal Separate Storm Sewer System
NPDES	National Pollutant Discharge Elimination System
NRCS	National Resource Conservation Service
PAH	Polycyclic aromatic hydrocarbon
PCB	Polychlorinated biphenyl
SCP	Site Cleanup Program
SEA	Significant Ecologic Area
SIC	Standard Industrial Classification
STA	Seal of Testing Assurance
SUSMP	Standard Urban Stormwater Mitigation Plan
SWQDv	Stormwater quality design volume
TKN	Total Kjeldahl Nitrogen
TMDL	Total maximum daily load
TMECC	Testing Method for the Examination of Compost and Composting
TSS	Total suspended solids
USCC	United States Composting Council
USEPA	United States Environmental Protection Agency

SECTION 1. INTRODUCTION

1.1. Purpose and Goals

The County of Los Angeles (County) has prepared the 2014 Low Impact Development Standards Manual (LID Standards Manual) to comply with the requirements of the National Pollutant Discharge Elimination System (NPDES) Municipal Separate Storm Sewer System (MS4) Permit for stormwater and non-stormwater discharges from the MS4 within the coastal watersheds of Los Angeles County (CAS004001, Order No. R4-2012-0175), henceforth referred to in this document as the 2012 MS4 Permit. The LID Standards Manual provides guidance for the implementation of stormwater quality control measures in new development and redevelopment projects in unincorporated areas of the County with the intention of improving water quality and mitigating potential water quality impacts from stormwater and non-stormwater discharges.

The LID Standards Manual is an update and compilation of the following documents:

- Development Planning for Storm Water Management: A Manual for the Standard Urban Storm Water Mitigation Plan (SUSMP Manual, September 2002);
- Technical Manual for Stormwater Best Management Practices in the County of Los Angeles (2004 Design Manual, February 2004);
- Stormwater Best Management Practice Design and Maintenance Manual (2010 Design Manual, August 2010); and
- Low Impact Development Standards Manual (2009 LID Manual, January 2009).

Additionally, the LID Standards Manual supersedes the water quality portions of the following ordinances and policies:

- Water Quality section of the Los Angeles County Hydrology Manual;
- Interim Drainage Policy for Quartz Hill;
- Acton Interim Drainage Policy and Guidelines;
- Antelope Valley Interim Drainage Policy;
- Financing the Cost to Maintain Standard Urban Stormwater Mitigation Plan Devices/Systems;
- Permanent Standard Urban Storm Mitigation Plan Devices for No Fee Miscellaneous Transfer Drains, Small Drainage Systems, and Storm Drain Connection Permits;
- Interim Peak Flow Runoff Criteria for New Development;
- Policy for New Percolation Basin Testing, Design, and Maintenance; and

- Clarification on the Policy for Financing the Cost to Maintain Standard Urban Stormwater Mitigation Plan (SUSMP) Devices/Systems Constructed by New Development or Other Agencies.

The LID Standards Manual addresses the following objectives and goals:

- Lessen the adverse impacts of stormwater runoff from development and urban runoff on natural drainage systems, receiving waters, and other water bodies;
- Minimize pollutant loadings from impervious surfaces by requiring development projects to incorporate properly-designed, technically-appropriate Best Management Practices (BMPs) and other Low Impact Development (LID) strategies; and
- Minimize erosion and other hydrologic impacts on natural drainage systems by requiring development projects to incorporate properly-designed, technically-appropriate hydromodification control development principles and technologies.

1.2. Organization of LID Standards Manual

The LID Standards Manual is organized as follows:

- Section 1 Introduction to the LID Standards Manual, presenting the environmental basis for stormwater management and applicable regulations and applicability of the LID Standards Manual.
- Section 2 Stormwater management requirements for Designated Projects.
- Section 3 Stormwater management requirements for Non-Designated Projects.
- Section 4 Information on site assessment and site design considerations.
- Section 5 Site-specific source control measures requirements.
- Section 6 Methodology required for calculating the volume of stormwater runoff that must be retained on-site.
- Section 7 Stormwater quality control measures and options for alternative compliance.
- Section 8 Hydromodification requirements.
- Section 9 Maintenance requirements for stormwater quality control measures.

1.3. Environmental Background

Historically, stormwater management has consisted of a network of impervious surfaces that directly convey stormwater runoff to curb and gutter systems, the storm drain conveyance system, and downstream receiving waters. Until recently, conventional storm drain and flood control systems were designed to convey stormwater away from

developed areas as quickly as possible to manage the risk of floods for homes and development. However, the County's most recent MS4 Permits require that stormwater management provide a more comprehensive approach to address stormwater runoff water quality and groundwater recharge opportunities.

In a natural setting, the following hydrologic functions occur:

- **Rainfall interception:** In a vegetated watershed, the surfaces of trees, shrubs, and grasses capture initial light precipitation before it reaches the ground. The interception of precipitation can delay the start and reduce the volume of stormwater runoff.
- **Shallow surface storage:** The shallow pockets present in natural terrain store rainfall and stormwater runoff, filter it, and allow it to infiltrate. This shallow surface storage can delay the start and reduce the volume of stormwater runoff.
- **Evaporation and transpiration:** Evaporation occurs when water changes from a liquid to a gas and moves into the air. Transpiration occurs when vegetation releases water vapor into the atmosphere. Both processes, collectively termed evapotranspiration, reduce the volume of stormwater runoff, locally return moisture into the atmosphere, and provide local cooling effects.
- **Infiltration:** Infiltration is the movement of surface water down through the soil into groundwater. Such movement filters and reduces the volume of stormwater runoff and replenishes groundwater supplies.
- **Runoff:** Runoff is the flow of water across the land surface that occurs after rainfall interception, surface storage, and infiltration reach capacity.

In natural settings, the majority of precipitation is either infiltrated into the soil or lost to evapotranspiration.

However, with urbanization and development, pervious surfaces (such as forests and meadows) are converted into impervious areas (i.e., building footprints, driveways, parking lots), and the percentage of precipitation that becomes stormwater runoff increases. The impacts of such conversion may include:

- Increased concentrations of nutrients, toxic pollutants, and bacteria in surface receiving waters, including adjacent land and habitat creeks, estuaries, and storm drain outlets;
- Higher peak flow rates and stormwater runoff volumes produced by storms;
- Decreased wet season groundwater recharge due to a reduced infiltration area;
- Increased dry weather urban runoff due to outdoor irrigation;
- Introduction of base flows in ephemeral streams due to surface discharge of dry weather urban runoff (i.e., irrigation runoff);
- Increased stream and channel instability and erosion due to increased stormwater runoff volumes, flow durations, and higher stream velocities (e.g., hydromodification impacts); and

- Increased stream temperature, which decreases dissolved oxygen levels and adversely impacts temperature-sensitive aquatic life, due to loss of riparian vegetation as well as stormwater runoff warmed by impervious surfaces.

This land use conversion is graphically presented in the stormwater runoff hydrograph in Figure 1-1 which compares pre- and post-development stormwater runoff characteristics. Ultimately, the increased stormwater pollutant load, if not managed properly, will adversely affect local water bodies.

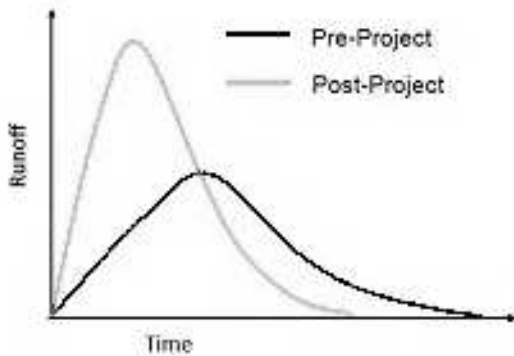

Figure 1-1. Pre- vs. Post-Project Hydrograph (Modified from Haltiner, 2006)

To mitigate these impacts, prior stormwater program efforts primarily focused on conventional stormwater quality control measures (e.g., BMPs), such as detention basins, which temporarily detain stormwater runoff and release it over a period of time (see Figure 1-2).

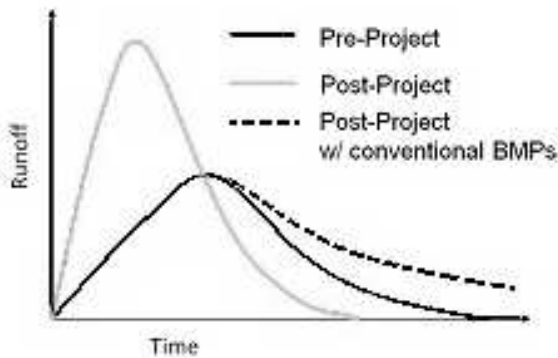

Figure 1-2. Hydrograph with Conventional Best Management Practices (Modified from Haltiner, 2006)

1.4. Low Impact Development Strategies and Goals

To enhance pollutant removal and groundwater recharge benefits, improvements can be made beyond conventional stormwater quality control measures through the use of LID strategies, which were incorporated into the 2012 MS4 Permit and LID Ordinance. LID is a decentralized approach to stormwater management that works to mimic the natural hydrology of the site by retaining precipitation on-site to the maximum extent practicable. Stormwater quality control measures that incorporate LID principles are placed throughout the site in small, discrete units and distributed near the source of impacts. LID strategies are designed to protect surface and groundwater quality, maintain the integrity of ecosystems, and preserve the physical integrity of receiving waters by managing stormwater runoff at or close to the source.

The purpose of LID is to reduce and/or eliminate the altered areas of the post-development hydrograph, as shown by the shaded areas in Figure 1-3, by reducing the peak discharge rate, volume, and duration of flow through the use of site design and stormwater quality control measures. The benefits of reduced stormwater runoff volume include reduced pollutant loadings and increased groundwater recharge and evapotranspiration rates.

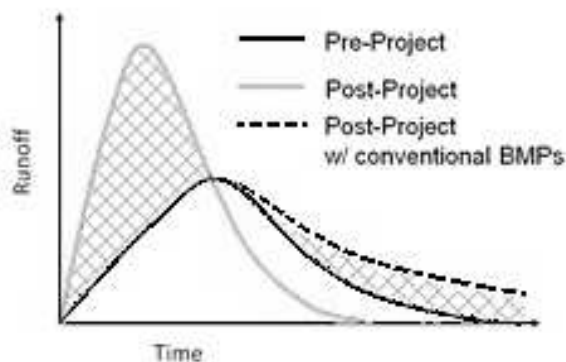

Figure 1-3. Goal of Low Impact Development is to Mimic the Pre-Project Hydrograph through Reduction in Peak Runoff Volume and Flow (Modified from Haltiner, 2006)

LID strategies include use of bioretention/infiltration landscape areas, disconnected hydrologic flow paths, reduced impervious areas, functional landscaping, and grading to maintain natural hydrologic functions that existed prior to development, such as interception, shallow surface storage, infiltration, evapotranspiration, and groundwater recharge. By implementing LID strategies, a project site can be designed to be an integral part of the environment by maintaining undeveloped hydrologic functions through the careful use of stormwater quality control measures.

Implementation of LID strategies also provides environmental, land value, and quality of life benefits including the following:

- **Pollution Abatement**: Pollutant removal, which is achieved through settling, filtration, adsorption, and biological uptake, can improve habitat for aquatic and terrestrial wildlife and enhance recreational uses.

- Protection of Downstream Water Resources: LID practices eliminate and/or mitigate hydrologic impacts on receiving waters, reduce stream channel degradation from erosion and sedimentation, improve water quality, increase water supply, and enhance the recreational and aesthetic value of natural resources.
- Groundwater Recharge: Some LID practices can recharge groundwater through infiltration. Growing water shortages nationwide increasingly require water resource management strategies designed to integrate stormwater, drinking water, and wastewater programs to maximize benefits and minimize costs.
- Habitat Improvements: LID practices can be used to improve natural resources and wildlife habitat, and maintain or increase land value.
- Real Estate Value/Property Tax Revenue: Various LID-designed projects and smart growth studies have shown that people are willing to pay more for clustered homes than conventionally-designed subdivisions. The United States Environmental Protection Agency (USEPA) study, *Economic Benefits of Runoff Controls* (September 1995), describes examples where developers and subsequent homeowners have received premiums for proximity to attractive stormwater management control measures. Additionally, real estate value for clustered housing with open space has appreciated at a higher rate than conventionally-designed subdivisions.
- Aesthetic Value: LID practices typically include attractive features because landscaping, such as trees, shrubs, and flowering plants, is an integral part of design. The use of these designs may increase property values and/or result in faster sale of the property due to the perceived value of the extra landscaping.
- Quality of Life/Public Participation: Placing LID features on individual lots provides opportunities to involve homeowners in stormwater management and enhances public awareness of stormwater runoff water quality issues. An American Lives, Inc. real estate study found that 77.7 percent of potential homeowners rated natural open space as essential or very important in planned communities.

1.5. Regulatory Background

In 1972, the Federal Water Pollution Control Act (Clean Water Act [CWA]) was amended to require NPDES permits for the discharge of pollutants to waters of the United States from any point source. In 1987, the CWA was amended to add Section 402(p), which required that municipal, industrial, and construction stormwater discharges be regulated under the NPDES permitting program. Since 1987, USEPA has promulgated various regulations to guide the permitting of these discharges.

Municipal Separate Storm Sewer System Permits

On June 18, 1990, the Los Angeles Regional Water Quality Control Board (Regional Water Board) adopted Order No. 90-079 (1990 MS4 Permit), which was the first MS4 permit for the County and incorporated areas therein. On December 13, 2001, the

Regional Water Board adopted Order No. 01-182 (2001 MS4 Permit), which replaced the 1990 MS4 Permit and regulated stormwater and non-stormwater discharges within the coastal watersheds of the County, and applied to the Los Angeles County Flood Control District, the unincorporated areas of Los Angeles County under County jurisdiction with the exception of a portion of Antelope Valley including the Cities of Lancaster and Palmdale and the City of Avalon, and 84 cities within the Los Angeles County Flood Control District with the exception of the City of Long Beach. The 2001 MS4 Permit was subsequently amended several times to incorporate new provisions and requirements.

As part of the 2001 MS4 Permit, the County was required to comply with the Standard Urban Stormwater Mitigation Plan (SUSMP). In September 2002, the County developed the SUSMP Manual to comply with the requirements of the 2001 MS4 Permit. The SUSMP Manual outlined BMPs to be incorporated into design plans for certain categories of new development and redevelopment projects. The County subsequently developed the 2004 Design Manual, which was updated in 2010 (2010 Design Manual) and the 2009 LID Manual to further enhance its stormwater management efforts for new development and redevelopment projects.

On November 8, 2012, the Regional Water Board adopted Order No. R4-2012-0175 (2012 MS4 Permit), which replaced the 2001 MS4 Permit. Similar to the 2001 MS4 Permit, the 2012 MS4 Permit required that the County implement a Planning and Land Development Program for certain categories of new development and redevelopment projects. However, the most significant difference between the two MS4 permits is that the 2012 MS4 Permit requires new development and redevelopment projects in general, to retain, on-site, a specified volume of stormwater runoff (the Stormwater Quality Design Volume [SWQDV]) from a design storm event. This LID Standards Manual provides guidance on how new development and redevelopment projects can meet these on-site retention requirements through the use of stormwater quality control measures.

Low Impact Development Ordinance

In October 2008, the County adopted an LID Ordinance into the Los Angeles County Code Title 12, Chapter 84 to require the use of LID principles in all development projects except road and flood infrastructure projects. With the 2012 MS4 Permit, it became necessary for the County to modify this ordinance to reflect the new stormwater runoff water quality and hydromodification requirements for new development and redevelopment projects. In November 2013, the County amended the Los Angeles County Code Title 12, Chapter 84 to incorporate the requirements of the 2012 MS4 Permit. The November 2013 LID Ordinance became effective December 5, 2013, and requires that all Designated, Non-Designated, street and road construction, and single-family hillside home projects comply with Los Angeles County Code Title 12, Chapter 84. This LID Standards Manual was prepared to complement and be consistent with the November 2013 LID Ordinance requirements.

Ultimately, a project applicant must submit a comprehensive LID Plan and analysis demonstrating compliance with the LID Standards Manual (which also constitutes compliance with the November 2013 LID Ordinance) for review and approval by the Director of Public Works.

Other State of California Regulations

In addition to the County requirements, owners/developers of some project sites may be subject to the Waste Discharge Requirements for Discharges of Storm Water Associated with Industrial Activities Excluding Construction Activities (Industrial General Permit, Order No. 97-03-DWQ) and/or the General Permit for Storm Water Discharges Associated with Construction and Land Disturbance Activities (Construction General Permit, Order No. 2012-0006-DWQ), which were adopted by the California State Water Resources Control Board (State Water Board). The State Water Board is expected to adopt a new Industrial General Permit in early 2014.

1.6. Applicability of the LID Standards Manual

All Designated, Non-Designated, street and road construction, and single family hillside home projects within the Unincorporated Areas of the County are required to comply with the LID Standards Manual. Designated and Non-Designated Projects are discussed in Sections 2 and 3, respectively. Requirements for street and road construction and single-family hillside home projects are discussed in the following sections.

Street and Road Construction

Development projects involving street and road construction of 10,000 square feet or greater of impervious surface area are required to comply with the requirements in the LID Standards Manual. Additionally, these types of projects must follow the USEPA guidance, *Managing Wet Weather with Green Infrastructure: Green Streets 26* (December 2008 EPA-833-F-08-009), to the maximum extent practicable. This subsection applies to standalone streets, roads, highways, and freeway projects, and also applies to streets within larger development projects.

Single-Family Hillside Homes

Development projects involving construction of a single-family home in a hillside management area (as defined in Section 22.08.080 of Title 22 of Los Angeles County Code) are required to comply with the requirements in the LID Standards Manual. Additionally, these types of projects must implement the following measures:

- Conserve natural areas;
- Protect slopes and channels;
- Provide storm drain system stenciling and signage;

- Divert roof runoff to vegetated areas before discharge unless the diversion would result in slope instability; and
- Direct surface flow to vegetated areas before discharge unless the diversion would result in slope instability.

Exemptions to the LID Standards Manual

The following types of projects are exempt from implementing the requirements of the LID Standards Manual:

- Any Non-Designated Project that results in an addition or alteration of less than 50 percent of the impervious surfaces of an existing developed site consisting of four or fewer residential units; and
- Any development where a complete discretionary or non-discretionary permit application was filed with the County of Los Angeles Departments of Regional Planning or Public Works, or any County-controlled design control board, prior to January 1, 2009.

1.7. Project Plan Submittals

The project applicant must submit an LID Plan for review and approval by the Director of Public Works that provides a comprehensive, technical discussion of how the proposed project will comply with the requirements of the LID Ordinance and LID Standards Manual. The LID Plan must include the following information:

- Identification of whether the proposed project is a Designated or Non-Designated Project. If the proposed project is a Designated Project, identification of the project category (see Sections 2 and 3);
- Feasibility of infiltration including a percolation report as part of a geotechnical report prepared by a geotechnical engineer (see Section 4 and Appendix C);
- Source control measure(s) proposed to be implemented (see Section 5)
- Calculation of the SWQDv (see Section 6);
- Discussion on whether stormwater runoff harvest and use is feasible (see Section 7);
- Stormwater quality control measure(s) proposed to be implemented (see Section 7);
- Discussion of how the applicable water quality standards and total maximum daily loads (TMDLs) will be addressed (off-site mitigation projects only) (see Section 7);
- Proposed hydromodification controls and calculations (if necessary) (see Section 8); and
- Proposed maintenance plan (if necessary) (see Section 9).

Low Impact Development Standards Manual

The LID Plan will be:

- A section of or appendix to the Hydrology Report that must be submitted to the Land Development Division;
- A section of or appendix to the Grading Report submitted to the Building and Safety Division; or
- A separate plan.

If the proposed project intends to implement privately-maintained stormwater quality control measure(s), the specific BMPs will be reviewed during the grading stage. If the proposed project intends to implement publicly-maintained stormwater quality control measure(s), the specific BMPs will be shown on water quality plans that are submitted separate from but concurrently with the storm drain plans.

SECTION 2. DESIGNATED PROJECT REQUIREMENTS

2.1. Introduction

This section describes the stormwater management requirements for Designated Projects, which are identified as meeting one or more of the following:

- All development projects equal to one acre or greater of disturbed area and adding more than 10,000 square feet of impervious surface area;
- Industrial parks with 10,000 square feet or more of surface area;
- Commercial malls with 10,000 square feet or more of surface area;
- Retail gasoline outlets with 5,000 square feet or more of surface area;
- Restaurants (Standard Industrial Classification [SIC] Code 5812) with 5,000 square feet or more of surface area;
- Parking lots with 5,000 square feet or more of impervious surface area, or with 25 or more parking spaces;
- Automotive service facilities (SIC Codes: 5013, 5014, 5511, 5541, 7532-7534, or 7536-7539) with 5,000 square feet or more of surface area;
- Projects located in or directly adjacent to, or discharging directly to a Significant Ecological Area (SEA), where the development will:
 - Discharge stormwater runoff that is likely to impact a sensitive biological species or habitat; and
 - Create 2,500 square feet or more of impervious surface area.
- Redevelopment projects, which are developments that result in creation or addition or replacement of either: (1) 5,000 square feet or more of impervious surface on a site that was previously developed as described in the above bullets; or (2) 10,000 square feet or more of impervious surface area on a site that was previously developed as a single family home.
 - Where 50 percent or more of the impervious surface of a previously developed site is proposed to be altered and the previous development project was not subject to post-construction stormwater quality control measures, the entire development site (e.g., both the existing development and the proposed alteration) must meet the requirements of the LID Standards Manual.
 - Where less than 50 percent of the impervious surface of a previously developed site is proposed to be altered and the previous development project was not subject to post-construction stormwater quality control measures, only the proposed alteration must meet the requirements of the LID Standards Manual.
 - Redevelopment does not include routine maintenance activities that are conducted to maintain original line and grade, hydraulic capacity, original

purpose of facility or emergency redevelopment activity required to protect public health and safety. Impervious surface replacement, such as the reconstruction of parking lots and roadways, which does not disturb additional area and maintains the original grade and alignment, is considered routine maintenance activity. Redevelopment does not include repaving of existing roads to maintain original line and grade.

2.2. Stormwater Management Requirements for Designated Projects

All Designated Projects must retain 100 percent of the SWQDv on-site through infiltration, evapotranspiration, stormwater runoff harvest and use, or a combination thereof unless it is demonstrated that it is technically infeasible to do so. To meet these requirements, Designated Projects must:

- Conduct site assessment and identify design considerations, including determining the feasibility of on-site infiltration (see Section 4 and Section 7.3);
- Apply site-specific source control measures (see Section 5);
- Calculate the Stormwater Quality Design Volume (see Section 6);
- Implement stormwater quality control measures (see Section 7);
- Implement alternative compliance measures, if necessary (see Section 7);
- Implement hydromodification requirements, if necessary (see Section 8); and
- Develop a Maintenance Plan, if necessary (see Section 9).

A flow chart outlining the design process for Designated Projects is presented in Figure 2-1.

Low Impact Development Standards Manual

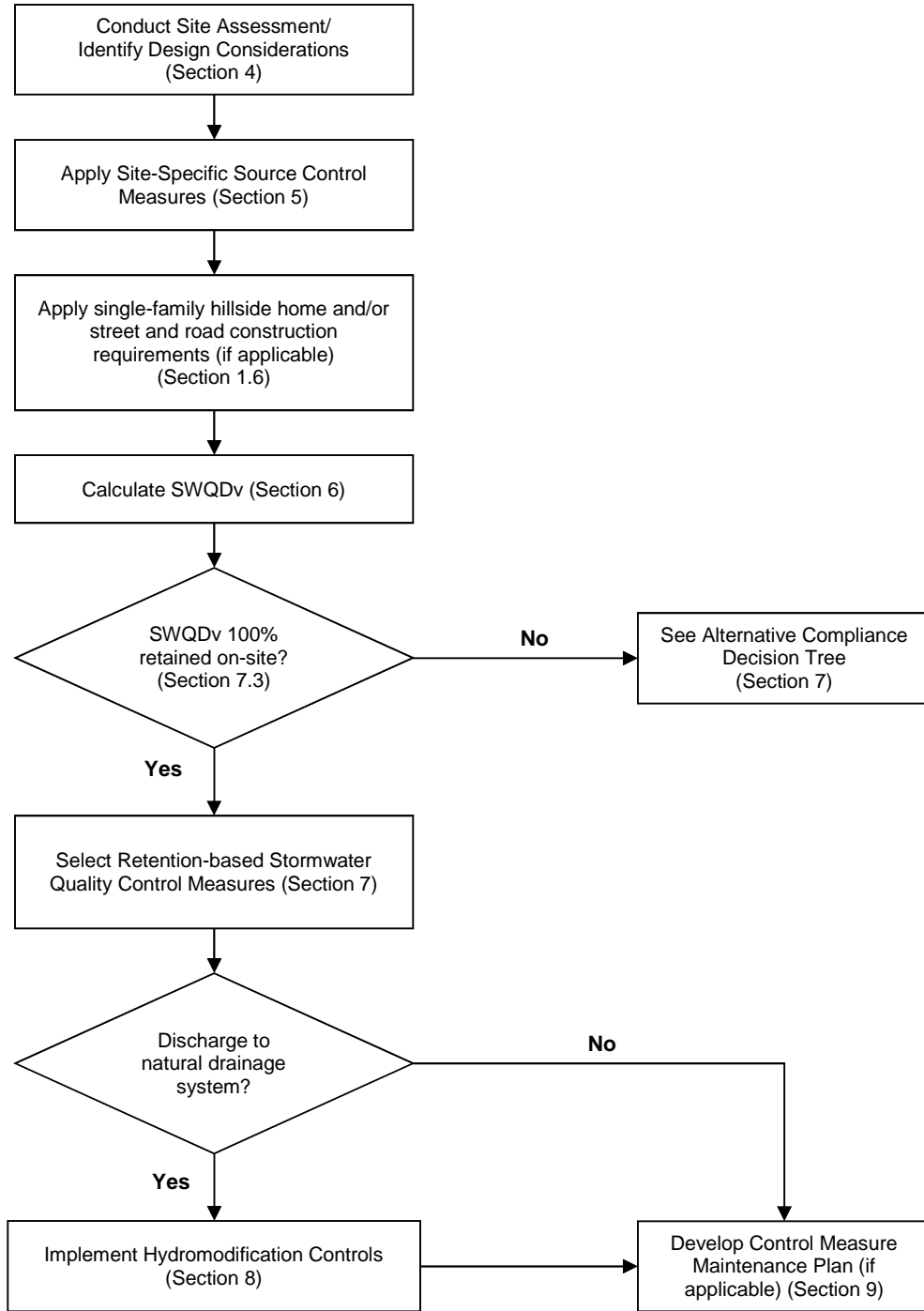

Figure 2-1. Design Process for Meeting Stormwater Requirements for Designated Projects

SECTION 3. NON-DESIGNATED PROJECT REQUIREMENTS

3.1. Introduction

The County defines any project that is not a Designated Projects (Section 2) as a Non-Designated Project. Non-Designated Projects fall into the following categories:

- Small-Scale Non-Designated Residential Projects – residential development and redevelopment of four units or less; and
- Large-Scale Non-Designated Projects – all residential development and redevelopment of five units or greater and all non-residential development or redevelopment.
 - Where 50 percent or more of the impervious surface of a previously developed site is proposed to be altered and the previous development project was not subject to post-construction stormwater quality control measures, the entire development site (e.g., both the existing development and the proposed alteration) must meet the requirements of the LID Standards Manual.
 - Where less than 50 percent of the impervious surface of a previously developed site is proposed to be altered and the previous development project was not subject to post-construction stormwater quality control measures, only the proposed alteration must meet the requirements of the LID Standards Manual.

A flow chart outlining the design process for Non-Designated Projects is presented in Figure 3-1.

Low Impact Development Standards Manual

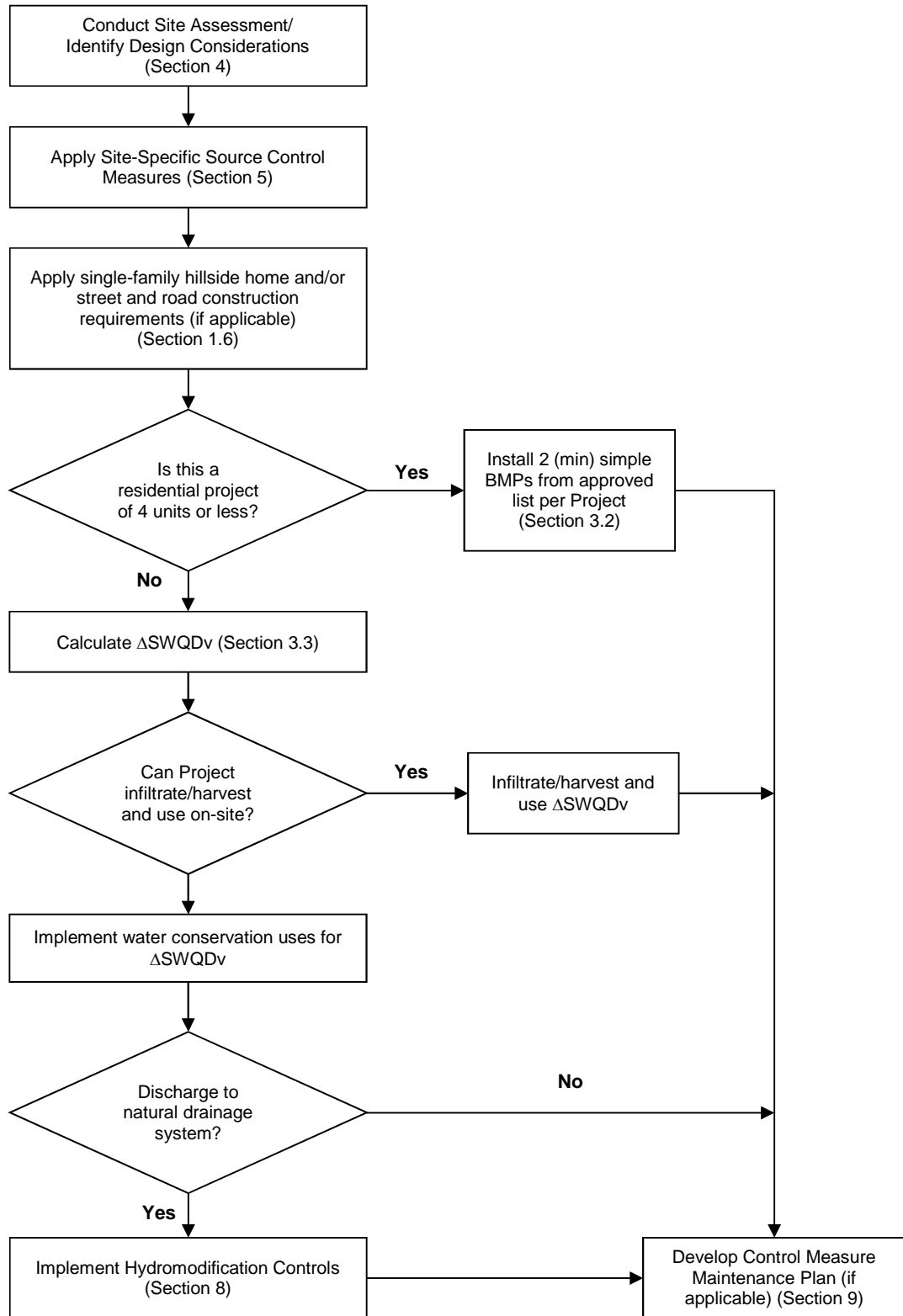

Figure 3-1. Design Process for Meeting Stormwater Requirements for Non-Designated Projects

3.2. Stormwater Management Requirements for Small-Scale Non-Designated Projects

Residential development and redevelopment of four units or less are required to implement at least two of the following simple BMPs into the site design:

- Porous pavement: Install porous pavement to allow stormwater runoff to infiltrate through it. Porous pavement includes, but is not limited to, porous asphalt, porous concrete, ungrouted paving blocks, and gravel. At least 50 percent of the pavement at the site must be porous.
- Downspout routing: Each roof downspout must be directed to one of the following simple BMPs, which must have a total capacity of at least 200 gallons:
 - Rain barrel/cistern: Stored stormwater runoff can be used for irrigation or other non-potable uses as permitted under the Los Angeles County Building/Plumbing Code.
 - Rain garden/planter box: Stormwater runoff can be retained or treated by these stormwater quality control measures.
- Disconnect impervious surfaces: Slope driveways and other impervious surfaces to drain toward pervious surfaces. If possible, stormwater runoff should be directed toward vegetated areas or stormwater quality control measures. One-third of the lot must be pervious areas such as landscaping, gravel, or porous pavement. Limit the total area not directed toward vegetated areas or stormwater quality control measures to 10 percent or less of the area of the site.
- Dry well: Install a dry well to infiltrate stormwater runoff. The dry well must be sized to contain and infiltrate at least 200 gallons of stormwater runoff in a 96-hour period.
- Landscaping and landscape irrigation: Plant trees near impervious surfaces to intercept precipitation in their leaves. Trees planted adjacent to impervious surfaces can intercept water that would otherwise become stormwater runoff. A minimum of two 15-gallon trees must be planted a maximum of 10 feet from impervious surfaces. Install irrigation systems that utilize a weather-based smart irrigation controller to minimize water usage and reduce dry weather urban runoff.
- Green roof: Install a green roof to retain and treat stormwater runoff on the rooftop. A green roof must cover at least 50 percent of the total rooftop area.

The project applicant is required to submit a geotechnical report, prepared by a geotechnical engineer, when proposing use of porous pavement or dry wells.

3.3. Stormwater Management Requirements for Large-Scale Non-Designated Projects

Large-Scale Non-Designated Projects include all Non-Designated residential developments of five units or greater and all non-residential, Non-Designated Projects. Large-Scale Non-Designated Projects are required retain on-site the $\Delta SWQDv$ through infiltration, evapotranspiration, stormwater runoff harvest and use, or a combination thereof unless it is demonstrated that it is technically infeasible to do so. Retention of the $\Delta SWQDv$ can be accomplished on a lot-by-lot basis or a subregional scale provided that an equivalent benefit can be demonstrated. The following requirements apply:

- Retain the $\Delta SWQDv$ from each lot at the lot level; or
- Retain the $\Delta SWQDv$ from the entire project site, including streets and public right-of-way, in subregional facilities. The tributary area of a subregional facility shall generally be limited to five acres, but may be exceeded upon approval by the Director of Public Works.

To meet these requirements, Large-Scale Non-Designated Projects must:

- Conduct site assessment and identify design considerations (see Section 4);
- Apply site-specific source control measures (see Section 5);
- Calculate the $\Delta SWQDv$ (see next section);
- Implement stormwater quality control measures (see Section 7);
- Implement hydromodification requirements, if necessary (see Section 8); and
- Develop a Maintenance Plan, if necessary (see Section 9).

Delta Stormwater Quality Design Volume ($\Delta SWQDv$)

Large-Scale Non-Designated Projects are required to manage the difference between the stormwater runoff volume pre- and post-construction ($\Delta SWQDv$) through on-site retention. The $SWQDv$, from which the $\Delta SWQDv$ is calculated, is defined in Section 6. The $\Delta SWQDv$ is defined as the difference between undeveloped stormwater runoff volume (V_u) and the stormwater runoff volume post-development (V_d). The $\Delta SWQDv$ is calculated according to the following equation:

$$\Delta SWQDv = V_d - V_u$$

Where:

$\Delta SWQDv$ = Increase in stormwater runoff volume from the project [ft^3];
 V_d = Stormwater runoff volume post-development [ft^3]; and
 V_u = Undeveloped stormwater runoff volume [ft^3] (1% impervious).

An example calculation of the $\Delta SWQDv$ is presented in Appendix F.

SECTION 4. SITE ASSESSMENT AND DESIGN CONSIDERATIONS

This section discusses the steps for assessing project site conditions and identifying design considerations during the planning phase of a project to determine appropriate stormwater quality control measures for the project. This step in the planning and design process is important for identifying project site constraints that may limit or reduce the ability of a project site to meet the on-site retention requirement. Conducting this step early in the planning process reduces the possibility of having to re-design the project site if proposed stormwater quality control measures cannot feasibly meet the on-site retention requirement.

4.1. Assessing Site Conditions and Other Constraints

Assessing the potential to implement stormwater quality control measures at a project site requires both the review of existing information and the collection of site-specific data. Available information and data regarding site layout, geotechnical conditions, and local groundwater conditions that should be reviewed are discussed below. In addition, soil and infiltration testing is needed to determine if infiltration of stormwater runoff is feasible and the appropriate design infiltration rates for retention-based stormwater quality control measures.

Once a project site has been identified, an initial field investigation of the project site must be conducted to determine project site conditions and other constraints that may limit on-site retention of stormwater runoff and implementation of stormwater quality control measures. As part of this initial assessment, the project applicant must identify the following:

- Project area size (acreage);
- Drainage area (acreage and location via project site map);
- Location of point(s) of stormwater runoff discharge (storm drain system or receiving water);
- Land use types; and
- Activities expected on-site.

The project area size and drainage area are important factors in determining the sizing and placement of stormwater quality control measures. Identifying the point(s) of discharge of stormwater runoff from the project site is necessary to determine where stormwater runoff conveyance and/or stormwater quality control measures need to be located. Identifying the land use type and determining the activities expected to be conducted on-site before, during, and after construction is important in assessing potential pollutants of concern that may be present in stormwater runoff.

Geotechnical Conditions

As stated previously, a geotechnical report must be prepared by a geotechnical engineer as part of the LID Plan submittal to the Los Angeles County Department of Public Works (LACDPW). The geotechnical report should consider the following conditions, which are discussed in further detail below:

- Topography;
- Soil type and geology;
- Groundwater;
- Other geotechnical hazards; and
- Setbacks.

Topography

The project site topography must be evaluated for surface drainage patterns, topographic high and low points, and the presence of steep slopes. Each of these site characteristics impacts the type of stormwater quality control measure that will be most beneficial for the project site. For example, retention-based stormwater quality control measures are more effective on level or gently-sloped sites than steeply-sloped sites.

Soil Type and Geology

The soil type and geologic conditions of the project site must be evaluated to determine the potential for infiltration and to identify suitable as well as unsuitable locations for retention-based stormwater quality control measures. Early identification of soil types at the project site can reduce the number of test pit investigations and infiltration tests needed by narrowing potential test sites to areas that are most likely suitable for infiltration. All infiltration tests for determining the infiltration feasibility must be performed according to the most recent Geotechnical and Materials Engineering Division (GMED) Policy GS 200.1.¹ Soils with a corrected in-situ infiltration rates of 0.3 in/hr or greater are considered feasible for retention-based stormwater quality control measures.

Available geologic or geotechnical reports on local geology should be reviewed to identify relevant features such as depth to bedrock, rock type, lithology, faults, or hydrostratigraphic or confining units. These geologic investigations, which may also identify shallow water tables and past groundwater issues, provide important information for site planning and stormwater quality control measure design.

¹ The most recent Geotechnical and Materials Engineering Division Policy GS 200.1 can be found at <http://dpw.lacounty.gov/gmed/permits/docs/policies/GS200.1.pdf>.

Groundwater

Site groundwater conditions must be considered prior to stormwater quality control measure siting, selection, sizing, and design. The depth to groundwater beneath the project site during the wet season may preclude infiltration if less than 10 feet of separation exists between the infiltration surface and the seasonal high groundwater or mounded groundwater levels. The depth to groundwater must be determined according to the most recent GMED Policy GS 200.1.

In areas with known groundwater pollution, infiltration should be avoided because it can potentially mobilize groundwater contamination. Areas with known groundwater impacts include sites listed by the Regional Water Board's Leaking Underground Storage Tank (LUST) Program and Site Cleanup Program (SCP). The State Water Board also maintains a database of registered contaminated sites through its "Geotracker" Program.

Other Geotechnical Issues

Infiltration can cause geotechnical issues, including settlement through collapsible soil, expansive soil movement, slope instability, and increased liquefaction hazard, due to a temporary increase in groundwater levels near retention-based stormwater quality control measures. Increased water pressure in soil pores reduces soil strength, which can make foundations more susceptible to settlement and slopes more susceptible to failure. In general, retention-based stormwater quality control measures must be set back from building foundations or steep slopes.

A geotechnical investigation must be performed to identify potential geotechnical issues and geological hazards that may result from implementing retention-based stormwater quality control measures. Recommendations for each site must be determined by a licensed geotechnical engineer based on soils boring data, drainage patterns, and current requirements for stormwater treatment. A geotechnical engineer's recommendations are essential to preventing damage from increased subsurface water pressure on surrounding properties, public infrastructure, sloped banks, and even mudslides.

Collapsible Soil

Collapsible soil is typically observed in sediments that are loosely deposited, separated by coatings or particles of clay or carbonate, and subject to saturation. Infiltration of stormwater runoff results in a temporary rise in the groundwater level. This rise in groundwater level can change the soil structure by dissolving or deteriorating the intergranular contacts between the sand particles and result in a sudden collapse, referred to as hydrocollapse. This phenomenon generally occurs during the first saturation episode after deposition of the soil, and repeated cycles of saturation are unlikely to result in further collapse. The magnitude of hydrocollapse is proportional to the thickness of the soil column where infiltration is occurring. In most instances, the magnitude of hydrocollapse will be small.

A geotechnical engineer should evaluate potential effects of hydrocollapse from retention-based stormwater quality control measures on nearby structures and roadways according to Section 3.5.3 of the County of Los Angeles Department of Public Works Manual for Preparation of Geotechnical Reports².

Expansive Soil

Expansive soil is soil or rock material that can potentially shrink or swell under changing moisture conditions. Expansive soils contain clay minerals that expand in volume when water is introduced and shrink when water is removed or the soil is dried. If expansive soil is present, a rise in groundwater level from stormwater runoff infiltration can introduce moisture and cause the soil to swell. Conversely, when the groundwater level decreases after infiltration, the soil will shrink in response to the loss of moisture in the soil structure. The effects of expansive soil movement (swelling and shrinking) are the greatest near surface structures such as shallow foundations, roadways, and concrete walks. Basements or below-grade parking structures can also be affected as additional loads are applied to the basement walls from the large swelling pressures generated by soil expansion. A geotechnical investigation should identify if expansive soils are present at a project site, and if they are, evaluate if implementation of retention-based stormwater quality control measures at the project site is feasible.

Slopes

Slopes can be affected by the temporary rise in groundwater level. The presence of a water surface near a slope can substantially reduce the stability of the slope compared to a dry condition. A groundwater mounding analysis can be performed to evaluate the potential increase in groundwater levels around a retention-based stormwater quality control measure. If the potential increase in groundwater level approaches nearby slopes, a slope stability evaluation should be conducted to determine the implications of the temporary groundwater surface. The geotechnical and groundwater mounding evaluations can identify the duration of the elevated groundwater level and provide safety factors consistent with the duration (e.g., temporary or long-term conditions).

Liquefaction

Seismically-induced soil liquefaction is a phenomenon in which saturated granular materials, typically possessing low to medium density, undergo matrix rearrangement, develop high pore water pressure, and lose shear strength due to cyclic ground motions induced by earthquakes. Soil liquefaction can cause a loss of bearing capacity for foundations, settling of surfaces, and tilting in level ground. Soil liquefaction can also result in instabilities and lateral spreading in embankments and areas of sloping ground.

² The County of Los Angeles Department of Public Works Manual for Preparation of Geotechnical Reports can be found at <http://dpw.lacounty.gov/gmed/permits/docs/manual.pdf>.

Because stormwater runoff infiltration can result in the saturation of subsurface soils above the existing groundwater table, a groundwater mounding analysis can evaluate the duration of the elevated groundwater level and the implications for liquefaction. If granular soils are sufficiently dense, it is unlikely that liquefaction will be of concern, regardless of groundwater mounding. If analyses indicate that the potential for liquefaction may increase due to stormwater runoff infiltration, then the liquefaction-induced settlement of structures, lateral spreading, and other surface manifestations will need to be evaluated.

Setbacks

The site assessment should also consider any required setbacks between stormwater quality control measures and property lines, public right-of-way, building foundations, slopes, drinking water wells, etc. Setback requirements are provided in the most recent GMED Policy GS 200.1.

Other Site Considerations

Managing Off-Site Drainage

Locations and sources of off-site run-on onto the project site must be identified and considered when evaluating appropriate stormwater quality control measures so that the run-on can be properly managed. Concentrated flows from off-site drainage may cause extensive erosion if not properly conveyed through or around the project site or otherwise managed. By identifying the locations and sources of off-site drainage, the volume of stormwater run-on may be estimated and factored into the siting and sizing of stormwater quality control measures. Vegetated swales or storm drains may be used to intercept, divert, and convey off-site drainage through or around the project site to prevent flooding or erosion that might otherwise occur.

Existing Utilities

Existing utility lines located at a project site may limit the possible locations of stormwater quality control measures. For example, retention-based stormwater quality control measures should not be located near utility lines where an increased volume of water could damage utilities. Stormwater runoff should be directed away from existing underground utilities, and project designs that require relocation of existing utilities should be avoided, if possible.

Significant Ecological Areas (SEAs)

The presence of SEAs may limit the siting of certain stormwater quality control measures, such as facilities that do not provide sufficient treatment of pollutants of concern. SEAs are typically delineated by, and fall under the regulatory oversight of state and federal agencies such as the United States Army Corps of Engineers, California Department of Fish and Game or United States Fish and Wildlife Service, or California Environmental Protection Agency. Stormwater quality control measures should be selected and appropriately sited to avoid adversely affecting an SEA.

4.2. Site Design Principles

Site design can protect sensitive environmental features such as riparian areas, wetlands, and steep slopes. The intention of site design principles is to reduce stormwater runoff peak flows and volumes and other impacts associated with land development. The benefits derived from this approach include:

- Reduction in size of stormwater quality control measures, and if necessary, conveyance systems;
- Reduction in pollutant loading to stormwater quality control measures and receiving waters; and
- Reduction in hydraulic impact on receiving waters.

Site design principles include the following:

- Site planning;
- Protection and restoration of natural areas;
- Minimization of land disturbance; and
- Minimize impervious cover.

Site design principles described in the following sections are required for all projects unless the project applicant demonstrates to the satisfaction of LACDPW that particular principles are not applicable to the proposed project, or the project site conditions make it infeasible to implement the site design principle in question. Site design principles such as minimizing of impervious cover can help meet the on-site retention requirement and possibly decrease the cost of implementing other stormwater quality control measures.

Site Planning

Purpose

Project applicants must implement a holistic approach to site design in order to develop a more hydraulically-functional site, help to maximize the effectiveness of on-site retention, and integrate stormwater management throughout the project site. Early project site planning can identify physical site constraints, reduce costs of downstream stormwater quality control measures, and prevent potential project site re-design.

Design Criteria

The following design criteria must be considered during the early planning stages:

- Use a multidisciplinary approach for site planning that includes planners, engineers, landscape architects, and architects at the initial phases of a project.

Low Impact Development Standards Manual

- Consider retention-based stormwater quality control measures as early as possible in the site planning process. Hydrology should be an organizing principle integrated into the initial site assessment planning phases.
- Plan for the space requirements of stormwater quality control measures. General space requirements for stormwater quality control measures are presented in Table 4-1.
- Distribute, if feasible, stormwater quality control measures throughout the project site. This may influence configuration of roads, buildings, and other infrastructure.
- Consider flood control early in the design stages. Even sites with stormwater quality control measures will still have stormwater runoff during large storm events that exceed the size of the design storm event.
- Use alternative building materials, if feasible, instead of conventional materials for the project. Several studies have indicated that metal used as roofing material, flashing, or gutters can leach metals into the environment. Avoid the use of roofing, gutters, and trim made of copper and galvanized (zinc) roofs, gutters, chain-link fences, and siding.
- Implement the Los Angeles County Green Standards Building Code (<http://planning.lacounty.gov/green>) requirements during the site planning stages.

Table 4-1. Typical Space Requirements for Stormwater Quality Control Measures

Stormwater Quality Control Measure	% of Contributing Drainage Area
Retention	3-10
Rainwater Harvesting (Cistern)	0-10
Evapotranspiration (Green Roof)	1:1 of impervious area treated
Biofiltration	3-5
Dry Extended Detention Basin	1-3
Wet Detention Basin	1-3
Sand Filters	0-5
Cartridge Media Filter	0-5

Source: Modified from *Urban Stormwater Retrofit Practices Manual 3* (Center for Watershed Protection, Ellicott City, MD. 2007).

Protect and Restore Natural Areas

Purpose

Conservation of natural areas, soils, and vegetation helps to retain numerous functions of pre-development hydrology, including rainfall interception, infiltration, and evapotranspiration. Each project site possesses unique topographic, hydrologic, and vegetative features, some of which are more suitable for development than others. Sensitive areas, such as streams and their buffers, floodplains, wetlands, steep slopes, and highly-permeable soils, should be protected and/or restored. Slopes can be a major source of sediment and should be properly protected and stabilized. Locating development in less sensitive areas of a project site and conserving naturally vegetated areas can minimize environmental impacts from stormwater runoff.

Design Criteria

If feasible, and consistent with applicable General Plan or Local Area Plan policies, for the project site, the following design features or elements must be included:

- Preserve historically undisturbed areas. Identify and cordon off streams and their buffers, floodplains, wetlands, and steep slopes.
- Maintain surface flow patterns of undeveloped sites, including water body alignments, sizes, and shapes.
- Reserve areas with high permeability soils for either open space or retention-based stormwater quality control measures.
- Incorporate existing trees into site layout.
- Identify areas that may be restored or revegetated either during or post-construction.
- Identify and avoid areas susceptible to erosion and sediment loss.
- Concentrate or cluster development on less sensitive areas of the project site, while leaving the remaining land in a natural, undisturbed state. Less sensitive areas may include, but are not limited to, areas that are not adjacent to receiving waters or areas where erosion may be an issue.
- Protect slopes from erosion by safely conveying stormwater runoff from the tops of slopes.
 - Vegetate slopes with native or drought-tolerant species.
 - Ensure slope protection practices conform to the applicable local erosion and sediment control standards and design standards. The design criteria described in this section are intended to enhance and be consistent with these local standards.
- Limit clearing and grading of native vegetation at the project site to the minimum amount needed to build lots, allow access, and provide fire protection.

- Maintain existing topography and existing drainage divides to encourage dispersed flow.
- Maximize trees and other vegetation at the project site by planting additional vegetation, clustering tree areas, and promoting use of native and/or drought-tolerant plants.
- Promote natural vegetation by using parking lot islands and other landscaped areas. Integrate vegetation-based stormwater quality control measures within parking lot islands and landscaped areas.

Minimize Land Disturbance

Purpose

The purpose of this site design principle is to protect water quality by preserving the natural hydrologic function of the project site to the maximum extent practicable. By designing a project site layout to preserve natural hydrology and drainageways at the project site, it reduces the need for grading and disturbance of native vegetation and soils. Siting buildings and impervious surfaces away from steep slopes, drainageways, and floodplains limits the amount of grading and clearing necessary and reduces the hydrologic impact. This site design principle is most applicable in greenfield settings, but opportunities to implement this principle may exist in redevelopment projects.

Native soils may contain organic material and soil biota that are ideal for on-site retention of stormwater runoff. Clearing, grading, and heavy equipment can remove and compact native soils and reduce soil infiltration capacity. The design criteria presented below are not intended to supersede compaction requirements associated with applicable local building codes.

Design Criteria

- Delineate and mark the development envelope for the project site on the site plan and physically demarcate the development envelope at the project site using temporary orange construction fencing or flagging. The development envelope is established by identifying the minimum area needed to build lots, allow access, provide fire protection, and protect and buffer sensitive features such as streams, floodplains, steep slopes, and wetlands. Concentrate building and paved areas on the least permeable soils, with the least intact habitat.
- Restrict equipment access and construction equipment storage to the development envelope.
- Consider soil amendments to restore permeability and organic content.

Minimize Impervious Area

Purpose

The potential for discharge of pollutants in stormwater runoff from a project site increases as the percentage of impervious area within the project site increases

because impervious areas increase the volume and rate of stormwater runoff. Pollutants deposited on impervious areas are easily mobilized and transported by stormwater runoff. Minimizing impervious area through site design is an important method to reducing the pollutant load in stormwater runoff.

In addition to the environmental and aesthetic benefits, a highly pervious site may allow reduction of potential downstream conveyance and stormwater quality control measures, yielding savings in development costs. Minimizing impervious area will also reduce the stormwater runoff coefficient, which is directly proportional to the volume of stormwater runoff that must be retained on-site.

Design Criteria

Some aspects of site design are directed by local building and fire codes and ordinances. (The project applicant must comply with all applicable building and fire codes and ordinances.) The design criteria recommended below are intended to enhance these local codes and ordinances. Suggested strategies for minimizing impervious areas through site design include the following:

- Use minimum allowable roadway and sidewalk cross sections, driveway lengths, and parking stall sizes.
- Use two-track/ribbon alleyways/driveways or shared driveways.
- Include landscape islands in cul-de-sacs streets (where approved). Consider alternatives to cul-de-sacs to increase connectivity.
- Reduce building and parking lot footprints. Building footprints may be reduced by building taller.
- Use pervious pavement material, such as modular paving blocks, turf blocks, porous concrete and asphalt, brick, and gravel or cobble, to accommodate overflow parking, if feasible.
- Cluster buildings and paved areas to maximize pervious area.
- Maximize tree preservation or tree planting.
- Avoid compacting or paving over soils with high infiltration rates (see Minimize Land Disturbance section).
- Use vegetated swales to convey stormwater runoff instead of paved gutters.
- Build compactly at redevelopment sites to avoid disturbing natural and agricultural lands and to reduce per capita impacts.

SECTION 5. SOURCE CONTROL MEASURES

5.1. Introduction

Source control measures are designed to prevent pollutants from contacting stormwater runoff or prevent discharge of contaminated stormwater runoff to the storm drain system and/or receiving water. This section describes structural-type, source control measures that must be considered for implementation in conjunction with appropriate non-structural source control measures, such as good housekeeping and employee training, to optimize pollution prevention. Non-structural source control measures are not discussed in the LID Standards Manual, but information for these control measures can be found in the *California Stormwater Best Management Practices Handbooks* (California Stormwater Quality Association, 2003). LACDPW may require additional source control measures not included in the LID Standards Manual for specific pollutants, activities, or land uses.

The source control measures presented in the LID Standards Manual apply to both stormwater and non-stormwater discharges. Non-stormwater discharges are discharges of any substance (i.e., excess irrigation, cooling water, and process wastewater) that is not comprised entirely of stormwater runoff. Any stormwater runoff that is mixed or comingled with non-stormwater flows is considered non-stormwater. Stormwater and non-stormwater discharges to the storm drain system or receiving water may be subject to local, state, or federal permitting prior to commencing discharge. The appropriate agency should be contacted prior to any discharge.

5.2. Descriptions

Source control measures should be implemented to the maximum extent practicable to mitigate pollutant mobilization from the project site in stormwater and non-stormwater runoff. A summary of the source control measures that should be implemented for each type of project is summarized in Table 5-1. Fact sheets for each source control measure are presented in Appendix D. These fact sheets include design criteria established by LACDPW to ensure effective implementation of the source control measures.

Low Impact Development Standards Manual

Table 5-1. Source Control Measures Selection Matrix

Project Type	Source Control Measure										
	Storm Drain Message and Signage (S-1)	Outdoor Material Storage Area (S-2)	Outdoor Trash Storage/ Waste Handling Area (S-3)	Outdoor Loading/Unloading Dock Area (S-4)	Outdoor Vehicle/Equipment Repair/Maintenance Area (S-5)	Outdoor Vehicle/ Equipment/ Accessory Wash Area (S-6)	Fuel & Maintenance Area (S-7)	Landscape Irrigation Practices (S-8)	Building Materials (S-9)	Animal Care and Handling Facilities (S-10)	Outdoor Horticulture Areas (S-11)
Designated Projects – New Development											
Development ≥1 acre and ≥10,000 ft ² new impervious area	R	R ¹	R ¹	R ¹	R ¹	R ¹	R ¹	R	R	R ¹	R ¹
Industrial parks (≥10,000 ft ²)	R	R ¹	R ¹	R ¹	R ¹	R ¹	R ¹	R	R	–	–
Commercial malls (≥10,000 ft ²)	R	R ¹	R ¹	R ¹	R ¹	R ¹	–	R	R	R ¹	R ¹
Retail gasoline outlets (≥5,000 ft ²)	R	R ¹	R ¹	R ¹	R ¹	R ¹	R ¹	R	R	–	–
Restaurants (≥5,000 ft ²)	R	R ¹	R ¹	R ¹	–	–	–	R	R	–	–
Parking lots (≥5,000 ft ² or ≥25 parking spaces)	R	R ¹	R ¹	R ¹	–	–	–	R	R	R ¹	R ¹
Automotive service facilities (5,000 ft ²)	R	R ¹	R ¹	R ¹	R ¹	R ¹	R ¹	R	R	–	–
Projects in/around Significant Ecologic Areas	R	R ¹	R ¹	R ¹	R ¹	R ¹	R ¹	R	R	R ¹	R ¹
Projects potentially impacting sensitive biological species or habitats	R	R ¹	R ¹	R ¹	R ¹	R ¹	R ¹	R	R	R ¹	R ¹
Projects adding ≥2,500 ft ² of impervious area	R	R ¹	R ¹	R ¹	R ¹	R ¹	R ¹	R	R	R ¹	R ¹

R = required; R¹ = required if outdoor activity area is included in project; R² = required for multi-family dwellings

Low Impact Development Standards Manual

Table 5-1. Source Control Measures Selection Matrix (continued)

Project Type	Source Control Measure										
	Storm Drain Message and Signage (S-1)	Outdoor Material Storage Area (S-2)	Outdoor Trash Storage/ Waste Handling Area (S-3)	Outdoor Loading/Unloading Dock Area (S-4)	Outdoor Vehicle/Equipment Repair/Maintenance Area (S-5)	Outdoor Vehicle/ Equipment/ Accessory Wash Area (S-6)	Fuel & Maintenance Area (S-7)	Landscape Irrigation Practices (S-8)	Building Materials (S-9)	Animal Care and Handling Facilities (S-10)	Outdoor Horticulture Areas (S-11)
Designated Projects – Redevelopment											
Projects creating or adding $\geq 5,000$ ft ²	R	R ¹	R ¹	R ¹	R ¹	R ¹	R ¹	R	R	R ¹	R ¹
Projects altering existing impervious surface	R	R ¹	R ¹	R ¹	R ¹	R ¹	R ¹	R	R	R ¹	R ¹
Non-Designated Projects											
Small-Scale Residential Projects	R	R ¹	R ²	–	–	–	–	R	R	–	–
Large-Scale Projects	R	R ¹	R ¹	R ¹	R ¹	R ¹	R ¹	R	R	R ¹	R ¹

R = required; R¹ = required if outdoor activity area is included in project; R² = required for multi-family dwellings

SECTION 6. STORMWATER QUALITY DESIGN VOLUME CALCULATION

6.1. Introduction

Current water quality requirements are based on treating a specific volume of stormwater runoff from the project site (stormwater quality design volume [SWQDv]). By treating the SWQDv, it is expected that pollutant loads, which are typically higher during the beginning of storm events, will be reduced in the discharge to or prevented from reaching the receiving waters. This section presents the procedure for calculating the SWQDv.

6.2. Stormwater Quality Design Volume (SWQDv)

The design storm, from which the SWQDv is calculated, is defined as the greater of:

- The 0.75-inch, 24-hour rain event; or
- The 85th percentile, 24-hour rain event as determined from the Los Angeles County 85th percentile precipitation isohyetal map³.

The volume of stormwater runoff that must be retained at a project site is calculated using MODRAT.⁴ MODRAT uses the design storm and a time of concentration to calculate the stormwater runoff at different times during a storm. By calculating the stormwater runoff flows based on the rainfall distribution, a hydrograph can be developed. The area under the hydrograph curve is the volume of stormwater runoff. The procedure for calculating the stormwater runoff using the MODRAT is an iterative process. LACDPW has developed a regression equation to calculate the time of concentration. The procedures for calculating the time of concentration and SWQDv using MODRAT is described below:

Step 1: Assume Initial Time of Concentration

Assume an initial time of concentration (t_c).

Step 2: Calculate Rainfall Intensity

Calculate the rainfall intensity using the assumed initial time of concentration as the duration from the following equation:

³ County of Los Angeles Department of Public Works. *Analysis of 85th Percentile 24-hour Rainfall Depth Analysis within the County of Los Angeles* (February 2004) (<http://ladpw.org/wrd/publications>). A map of the 85th percentile 24-hour rainfall depth can be found at <http://dpw.lacounty.gov/wrd/hydrologygis/>.

⁴ Los Angeles County Department of Public Works. *Hydrology Manual* (January 2006).

$$I_t = I_{1440} \times \left(\frac{1440}{t} \right)^{0.47}$$

Where:

t = Duration = Assumed initial time of concentration [min];
 I_t = Rainfall intensity for the duration [in/hr]; and
 I₁₄₄₀ = 24-hour rainfall intensity [in/hr].

Step 3: Calculate Impervious Area and Stormwater Runoff Coefficient

Determine the impervious area of the project site from the following equation or from Appendix D of the 2006 Hydrology Manual:

$$IMP = \frac{\sum_{i=1}^n (IMP_i \times A_i)}{A_T}$$

Where:

IMP = Project site-specific percent impervious;
 IMP_i = Impervious area, i;
 A_i = Area, i [ft²]; and
 A_T = Total project site area [ft²].

Determine the undeveloped stormwater runoff coefficient, C_u, using the soil curve data from Appendix C and the rainfall intensity calculated in Step 2. Calculate the developed stormwater runoff coefficient using the following equation:

$$C_d = (0.9 \times IMP) + (1.0 - IMP) \times C_u$$

Where:

C_d = Developed project site stormwater runoff coefficient;
 IMP = Site-specific percent impervious for project site; and
 C_u = Undeveloped project site stormwater runoff coefficient.

Step 4: Calculate the Time of Concentration (T_c)

Calculate the time of concentration using the following equation:

$$T_c = \frac{0.31 \times L^{0.483}}{(C_d \times I_t)^{0.519} \times S^{0.135}}$$

Where:

T_c = Time of concentration [min];
 L = Longest flow path length from watershed boundary to outlet [ft];
 C_d = Developed project site stormwater runoff coefficient;
 I_t = Rainfall intensity for the duration [in/hr]; and
 S = Slope of longest flow path [ft/ft].

Step 5: Compare Initial Assumption with T_c

If the calculated time of concentration (Step 4) is within 0.5 minutes of the assumed time of concentration (Step 1), then the value is sufficient. If the calculated and estimated times of concentration differ by more than 0.5 minutes, round the calculated time of concentration (Step 4) to the nearest minute and use that value as the assumed time of concentration (Step 1) and restart the calculation again from Step 2.

Step 6: Calculate Peak Flow Rate

Round the calculated time of concentration to the nearest minute and recalculate the rainfall intensity and developed project site stormwater runoff coefficient. Calculate the peak flow rate using the rational equation:

$$Q = \frac{C_d \times I \times A}{43,560}$$

Where:

Q = Peak flow rate [cfs];
 C_d = Developed project site stormwater runoff coefficient;
 I = Rainfall intensity [in/hr]; and
 A = Project area [ft²].

Step 7: Calculate SWQDv

MODRAT relies on temporal rainfall distribution and the time of concentration to generate hydrographs. The steps for calculating stormwater runoff are presented in the 2006 Hydrology Manual. Manual calculations for generating hydrographs require a lot of time and careful organization. The calculations are ideally suited for a computer program, and have been included in the HydroCalc program discussed in Section 6.3. Use of this program is encouraged to reduce the time required to reach a solution.

6.3. HydroCalc Program

LACDPW developed a hydrologic calculator (HydroCalc), which is available at <http://dpw.lacounty.gov/wrd/publication/>. HydroCalc completes the full MODRAT calculation process and produces the peak stormwater runoff flow rates and volumes for single subareas. Because HydroCalc does not have reach routing capabilities, it is limited to watersheds and project areas up to 40 acres.

Low Impact Development Standards Manual

An example for the calculation of the time of concentration, peak flow rate, and SWQDv using this program is presented in Appendix F.

SECTION 7. STORMWATER QUALITY CONTROL MEASURES

7.1. Introduction

Stormwater quality control measures are required to augment site design principles and source control measures to reduce the volume of stormwater runoff and potential pollution loads in stormwater runoff to the maximum extent practicable. Stormwater quality control measures are designed to handle the frequent, smaller storm events, or the initial volume of stormwater runoff from larger storm events (typically referred to as first flush events). The first flush of larger storm events is the initial period of the storm where stormwater runoff typically carries the highest concentration and loads of pollutants. Small, frequent storm events represent most of the total annual average precipitation in the County.

The LID Ordinance requires that all Designated Projects retain the SWQDv on-site using retention-based stormwater quality control measures (infiltration and/or stormwater runoff harvest and use). The County also requires that Large-Scale Non-Designated Projects retain the Δ SWQDv on-site.

The following sections describe the procedure for selecting and implementing stormwater quality control measures, determining technical infeasibility with the on-site retention requirement, and implementing alternative compliance measures in situations where it is not feasible to meet the on-site retention requirement.

7.2. Stormwater Quality Control Measures

The stormwater quality control measures included in the LID Standards Manual are common non-proprietary control measures being implemented nationwide. The focus of the design criteria for stormwater quality control measures is the construction and implementation of stormwater quality control measures that meet stormwater runoff requirements in terms of on-site retention and pollutant removal. Projects must design and implement stormwater quality control measures that can handle the SWQDv or Δ SWQDv, and stormwater runoff in excess of this volume must be diverted around the stormwater quality control measures to prevent overloading.

The stormwater quality control measures in the LID Standards Manual are categorized into the following types:

- Retention-based stormwater quality control measures (RET-1 to RET-7);
- Biofiltration (BIO-1);
- Vegetation-based stormwater quality control measures (VEG-1 to VEG-4); and
- Treatment-based stormwater quality control measures (T-1 to T-6).

In general, all proposed projects must maximize on-site retention of the SWQDv or Δ SWQDv through infiltration and/or bioretention. If it is not feasible to fully infiltrate or use bioretention to handle the SWQDv or Δ SWQDv, stormwater runoff harvest and use is the next preferred control measure. Project applicants must verify requirements for stormwater runoff harvest and use with the California Department of Public Health. However, stormwater runoff harvest and use may not be feasible at all project locations.

For Designated Projects that are unable to fully retain the SWQDv on-site through retention-based stormwater quality control measures, alternative compliance measures (e.g., on-site biofiltration, off-site groundwater replenishment, off-site infiltration and/or bioretention, and off-site retrofit) must be implemented. Prior to off-site mitigation, the portion of the SWQDv that cannot be reliably retained on-site must be treated to meet effluent quality standards (see Section 7.4).

For Large-Scale Non-Designated Projects that cannot fully retain the Δ SWQDv on-site through retention-based stormwater quality control measures, water conservation measures that incorporate vegetation to promote pollutant removal and stormwater runoff volume reduction, integrate multiple uses, and/or promote percolation of stormwater runoff through soil media and allow it to discharge downstream slowly must be implemented. Any portion of the Δ SWQDv that will be discharged off-site must be treated. If the Director of Public Works determines that compliance with water conservation requirements is technically infeasible, in whole or in part, in response to a project applicant's submittal, the Director of Public Works will require that the project applicant submit, for approval by the Director of Public Works, a proposal that incorporates design features demonstrating compliance with LID requirements to the maximum extent practicable.

Various factors must be considered when selecting stormwater quality control measures. In addition to retaining stormwater runoff on-site or treating it to reduce target pollutants of concern, site considerations such as size of the drainage area, depth between the groundwater table and stormwater quality control measure, soil type and permeability, site slope, hydraulic head, size of stormwater quality control measure, and need for vegetation irrigation are important factors in selecting the appropriate stormwater quality control measure for a project site. Land requirements and costs to design, construct, and maintain stormwater quality control measures vary by type. Vector breeding considerations must also be addressed in selecting stormwater quality control measures because of the potential for nuisance and human health effects. General guidelines for selecting stormwater quality control measures are presented in Table 7-1.

Other Considerations for Designing Stormwater Quality Control Measures

Pretreatment Considerations

Pretreatment must be provided for stormwater quality control measures whose function may be adversely affected by sediment or other pollutants. Pretreatment may also be provided to facilitate the routine removal of sediment, trash, and debris, and to increase

the longevity of downstream stormwater quality control measures. Typical pretreatment options include presettling basins or forebays (small detention basins), vegetated swales, vegetated filter strips, hydrodynamic separators, oil/water separators, and catch basin inserts.

Retention-based Stormwater Quality Control Measures

Infiltration is the primary mechanism for reducing stormwater runoff for all retention-based stormwater quality control measures with the exception of stormwater runoff harvest and use. Soils should have sufficient organic content and sorption capacity to remove certain pollutants, but must be coarse enough to allow infiltration of stormwater runoff in a reasonable amount of time (e.g., less than 96 hours for above-ground ponded water to prevent vector breeding). Examples of suitable soils for infiltration are silty and sandy loams. Coarser soils, such as gravelly sands, have limited organic content and high permeability and therefore present a potential risk to groundwater from certain pollutants, especially in areas of shallow groundwater. The project applicant should consult with LACDPW to identify if vulnerable unconfined aquifers are located beneath the project site to determine if retention-based stormwater quality control measures are appropriate for the proposed project. In areas with unconfined aquifers, implementation of retention-based stormwater quality control measures should include appropriate pretreatment to ensure that the groundwater is protected from pollutants of concern.

In high-risk areas (i.e., areas at or near service/retail gasoline outlets, truck stops, and heavy industrial sites), the appropriateness of implementing retention-based stormwater quality control measures must be evaluated. It may not be technically feasible to meet the on-site retention requirement if the project site is located in an area where pollutant mobilization is a documented concern. The site assessment must determine if the proposed infiltration area is isolated from the high-risk areas and there is little chance of spill migration. The site assessment should also determine if pretreatment can sufficiently address pollutants of concern (see Section 7.4).

Additionally, retention-based stormwater quality control measures must be sited with appropriate setbacks from slopes, potable wells, non-potable wells, drain fields, springs, and buildings foundations according to the most recent GMED Policy GS 200.1.

Low Impact Development Standards Manual

Table 7-1. General Guidelines for Stormwater Quality Control Measures

Stormwater Quality Control Measure	Tributary Area (acres) ⁽¹⁾	Infiltration Rate ⁽²⁾		Maximum Slope ⁽²⁾		Hydraulic Head ⁽³⁾	Irrigation Required? ⁽⁴⁾	Vector Control Frequency ⁽³⁾	Maintenance Frequency ⁽³⁾
		≥0.3 in/hr	Any	~ 0%	< 15%				
Retention-based Stormwater Quality Control Measures									
Bioretention (RET-1)	<10	X			X	M	Y	M	M
Infiltration Basin (RET-2)	<10	X			X	H	Y*	L	M
Infiltration Trench (RET-3)	<10	X			X	H	N	L	L
Dry Well (RET-4)	<10	X		X		H	N	L	M
Permeable Pavement without an Underdrain (RET-5)	<10	X		X		M	N	L	L
Rain Barrel/Cistern (RET-6)	<0.25	n/a		n/a		n/a	N	H	L
Green Roof (RET-7)	n/a	n/a		n/a		n/a	Y	L	M
Biofiltration									
Biofiltration (BIO-1)	<10		X		X	M	Y	M	M

Notes to Table 7-1:

Source: Ventura County Technical Guidance Manual for Stormwater Quality Control Measures (2010) and City of Modesto Guidance Manual for Development Stormwater Quality Control Measures (2011).

⁽¹⁾ Stormwater quality control measures with a tributary area of 0.5 acres or more must be off-line unless otherwise approved by LACDPW.

⁽²⁾ X = stormwater quality control measure is suitable for listed site condition. n/a = not applicable.

⁽³⁾ H = High; M = Medium; L = Low. n/a = not applicable.

⁽⁴⁾ Y = Yes; N = No; Y* = Yes if vegetated.

Low Impact Development Standards Manual

Table 7-1. General Guidelines for Stormwater Quality Control Measures (continued)

Stormwater Quality Control Measure	Tributary Area (acres) ⁽¹⁾	Infiltration Rate ⁽¹²⁾		Maximum Slope ⁽²⁾		Hydraulic Head ⁽³⁾	Irrigation Required? ⁽⁴⁾	Vector Control Frequency ⁽³⁾	Maintenance Frequency ⁽³⁾
		≥0.3 in/hr	Any	~ 0%	< 15%				
Vegetation-based Stormwater Quality Control Measures									
Stormwater Planter (VEG-1)	<10		X		X	M	Y	M	M
Tree-well Filter (VEG-2)	<10		X		X	M	Y	M	M
Vegetated Filter Strips (VEG-3)	<10		X		X	L	Y	L	L
Vegetated Swales (VEG-4)	<10		X		X	L	Y	L	L
Treatment-based Stormwater Quality Control Measures									
Sand Filters (T-1)	Varies		X	X		H	N	L	H
Constructed Wetlands (T-2)	≥10		X	X		L	Y	H	H
Extended Detention Basin (T-3)	≥10		X	X		L	Y*	M	M
Wet Pond (T-4)	≥10		X	X		L	Y*	H	M
Permeable Pavement with an Underdrain (T-5)	<10		X	X		M	N	L	L
Proprietary Devices (T-6)	Varies ⁽⁵⁾								

Notes to Table 7-1:

Source: Ventura County Technical Guidance Manual for Stormwater Quality Control Measures (2010) and City of Modesto Guidance Manual for Development Stormwater Quality Control Measures (2011).

⁽¹⁾ Stormwater quality control measures with a tributary area of 0.5 acres or more must be off-line unless otherwise approved by LACDPW.

⁽²⁾ X = stormwater quality control measure is suitable for listed site condition. n/a = not applicable.

⁽³⁾ H = High; M = Medium; L = Low. n/a = not applicable.

⁽⁴⁾ Y = Yes; N = No; Y* = Yes if vegetated.

⁽⁵⁾ Site constraints for proprietary devices will vary depending on the type of device proposed, design specifications, and manufacturer. Proprietary devices must be approved for use by LACDPW.

Biofiltration

Biofiltration systems use vegetation and soils or other filtration media to treat stormwater runoff. As stormwater runoff passes through the vegetation and the filtration media, the combined effects of filtration, adsorption, and biological uptake remove pollutants. In biofiltration systems, organic material in the soils retains water and promotes pollutant adsorption (i.e., dissolved metals, petroleum hydrocarbons) into the soil matrix. Plants use soil moisture, promote the drying of the soil through transpiration, and uptake pollutants in their roots and leaves. Plants with extensive root systems also help to maintain infiltration rates. Vegetation also decreases the velocity of flow and allows for particulates to settle. Biofiltration systems must be designed according to specifications outlined in the Biofiltration Fact Sheet (BIO-1) in Appendix E of the LID Standards Manual.

Vegetation-Based Stormwater Quality Control Measures

Vegetation-based stormwater quality control measures use the same principles as biofiltration, described above, to treat stormwater runoff. However, vegetation-based stormwater quality control measures are not subject to the design specifications outlined in Attachment H of the 2012 MS4 Permit.

Proprietary Stormwater Quality Control Measures

Proprietary stormwater quality control measures that are proposed for a project must be reviewed and approved by LACDPW. More information on a number of vendors of proprietary devices is provided at http://dpw.lacounty.gov/wmd/bmp/accepted_bmps.cfm.

7.3. Technical Infeasibility

In order to demonstrate technical infeasibility, the project applicant must show that the project cannot reliably retain 100 percent of the SWQDv on-site, even with the maximum application of green roofs and stormwater runoff harvest and use, and submit a site-specific hydrologic and/or design analysis conducted and verified by a registered professional engineer, geologist, architect, and/or landscape architect. Technical infeasibility for on-site infiltration may result from conditions including the following:

- The corrected in-situ infiltration rate is less than 0.3 inches per hour, as determined according to the most recent GMED Policy GS 200.1, and it is not technically feasible to amend the in-situ soils to attain an infiltration rate necessary to achieve reliable performance of retention-based stormwater quality control measures for the SWQDv on-site;
- Locations where the seasonal high groundwater level is within 10 feet of the surface, as determined according to the most recent GMED Policy GS 200.1;
- Locations within 100 feet of a groundwater well used for drinking water;

- Brownfield development sites where infiltration poses a risk of pollutant mobilization;
- Other locations where pollutant mobilization is a documented concern (e.g., at or near properties that are contaminated or store hazardous substances underground);
- Locations with potential geotechnical hazards;
- Smart growth and infill or redevelopment locations where the density and/or nature of the project would create significant difficulty for compliance with the on-site retention requirement;
- Locations where infiltration may adversely impact biological resources; or
- Locations where infiltration may cause health and safety concerns.

It may be technically infeasible for stormwater runoff harvest and use for the following situations:

- Projects that would not provide sufficient irrigation or (where permitted) domestic grey water demand for use of stored stormwater runoff due to limited landscaping or extensive use of low water use plant palettes in landscaped areas;
- Projects that are required to use recycled water for landscape irrigation;
- Projects in which the harvest and use of stormwater runoff would conflict with local, state, or federal ordinances or building codes;
- Locations where storage facilities may cause potential geotechnical hazards as outlined in the geotechnical report; or
- Locations where storage facilities may cause health and safety concerns.

7.4. Alternative Compliance

For Designated Projects where it is determined to be technically infeasible to reliably retain 100 percent of the SWQDv on-site, alternative compliance measures must be implemented. The project applicant must implement at least one of the following alternative compliance measures:

- On-site biofiltration of 1.5 times the volume of the SWQDv that is not reliably retained on-site;
- On-site treatment and off-site infiltration/bioretenion of the volume of the SWQDv that is not reliably retained on-site;
- Replenishment of groundwater supplies that have a designated beneficial use in the *Water Quality Control Plan: Los Angeles Region, Basin Plan for the Coastal Watersheds of Los Angeles and Ventura Counties* (Basin Plan), which was most recently adopted in June 1994 by the Regional Water Board and subsequently amended; or

Low Impact Development Standards Manual

- On-site treatment and off-site infiltration/bioretenion or stormwater runoff harvest and use of the volume of SWQDv that is not reliably retained on-site through retrofit an existing development with similar land uses as the project.

A flow chart outlining process for implementing alternative compliance measures is presented in Figure 7-1.

Low Impact Development Standards Manual

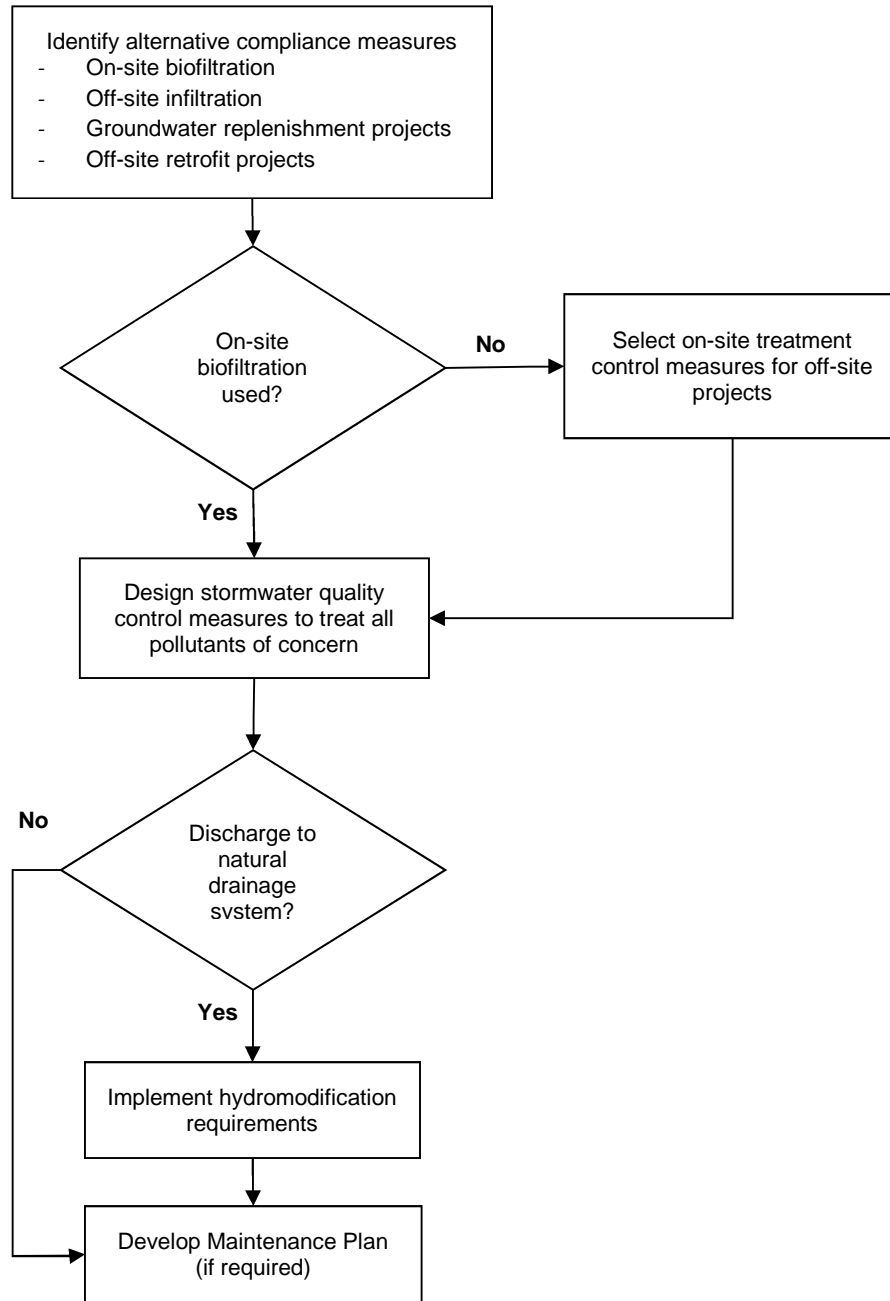

Figure 7-1. Alternative Compliance Measures for Designated Projects

On-Site Biofiltration

The project applicant may implement on-site biofiltration to provide treatment of stormwater runoff prior to discharge. A biofiltration system consists of a vegetated shallow depression that is designed to receive and infiltrate stormwater runoff from downspouts, piped inlets, or sheet flow from adjoining paved areas. A shallow ponding zone is provided above the vegetated surface to temporarily store captured stormwater runoff. During storm events, stormwater runoff accumulates in the ponding zone and gradually infiltrates and filters through the biofiltration soil media. A project applicant may implement on-site biofiltration if the biofiltration system is design to:

- Conform to the design specifications outlined in Biofiltration Fact Sheet (BIO-1) in Appendix E.
- Biofiltrate 1.5 times the portion of the SWQDv that is not reliably retained on-site, as calculated by the equation below:

$$V_B = 1.5 \times (SWQDv - V_R)$$

Where:

V_B = Biofiltration volume;

SWQDv = Stormwater quality design volume; and

V_R = Volume of stormwater runoff reliably retained on-site.

- Achieve enhanced nitrogen removal capability if the proposed project will discharge into a receiving water that is included in the 303(d) List of impaired water quality-limited water bodies due to nitrogen compounds or related effects. The design criteria for underdrain placement to achieve enhanced nitrogen removal are presented in the Biofiltration Fact Sheet (BIO-1) in Appendix E.

Off-Site Infiltration

If it is not technically feasible to reliably retain 100 percent of the SWQDv on-site, the project applicant may proposed to infiltrate off-site the volume of the SWQDv that is not reliably retained on-site at an approved off-site location. Off-site infiltration must be approved by the LACDPW and may require approval from the Regional Water Board Executive Officer, if petitioned by a third-party for review. If approval from the Regional Water Board Executive Officer is required, the project will be publicly-noticed on the Regional Water Board website for 30 days prior to approval.

The volume that must be mitigated is calculated according to the following equation:

$$V_M = 1.0 \times (SWQDv - V_R)$$

Where:

V_M = Mitigation volume [ft³];

SWQDv = Stormwater quality design volume [ft³]; and

V_R = Volume of stormwater runoff reliably retained on-site [ft³].

In order to use off-site infiltration for alternative compliance, the mitigation volume must be treated to reduce pollutant concentrations prior to conveyance off-site (see below).

The project applicant may install a flow-through modular treatment system, including sand filters or other proprietary stormwater quality control measure with a demonstrated efficiency at least equivalent to a sand filter. However the project applicant must still verify that the project site adequately treats the pollutants of concern. The sizing of the flow-through stormwater quality control measure is based on a rainfall intensity of:

- 0.2 inches per hour; or
- The one-year, one-hour rainfall intensity as determined from the most recent Los Angeles County isohyetal map, whichever is greater.

Groundwater Replenishment Projects

If the project applicant chooses to replenish groundwater at an off-site location, the project applicant must demonstrate the following:

- Why it is not advantageous to replenish groundwater at the project site;
- That groundwater can be used for beneficial purposes at the off-site location; and
- That the alternative measures also provide equal or greater water quality benefits to the receiving water than retaining stormwater runoff on-site.

Groundwater replenishment projects must be approved by LACDPW and may require approval from the Regional Water Board Executive Officer, if petitioned by a third-party for review. If approval from the Regional Water Board Executive Officer is required, the project will be publicly-noticed on the Regional Water Board website for 30 days prior to approval.

In order to use groundwater replenishment as an alternative compliance measure, the project must intercept and replenish the difference between the SWQDv and volume of stormwater runoff that is reliably retained at the project site. This groundwater replenishment volume is calculated according to the following equation:

$$V_M = 1.0 \times (SWQDv - V_R)$$

Where:

- V_M = Mitigation volume [ft³];
- $SWQDv$ = Stormwater quality design volume [ft³]; and
- V_R = Volume of stormwater runoff reliably retained on-site [ft³].

In order to use off-site groundwater replenishment for alternative compliance, the mitigation volume must be treated to reduce pollutant concentrations prior to conveyance off-site (see below).

The project applicant may install a flow-through modular treatment system, including sand filters or other proprietary stormwater quality control measure with a demonstrated efficiency at least equivalent to a sand filter. However the project applicant must still verify that the project site adequately treats the pollutants of concern. The sizing of the flow-through stormwater quality control measure is based on a rainfall intensity of:

- 0.2 inches per hour; or
- The one-year, one-hour rainfall intensity as determined from the most recent Los Angeles County isohyetal map, whichever is greater.

Groundwater replenishment projects must be located in the same sub-watershed (defined as draining to the same HUC-12 hydrologic area in the Basin Plan) as the proposed project, which does not reliably retain 100 percent of the SWQDv. LACDPW may consider locations outside of the HUC-12, but within the HUC-10 sub-watershed if there are no opportunities within the HUC-12 sub-watershed or if greater pollutant reductions and/or groundwater replenishment can be achieved at a location within the expanded HUC-10 sub-watershed.⁵

Off-Site Retrofit of Existing Development

If it is not technically feasible to reliably retain 100 percent of the SWQDv on-site, the project applicant may propose to implement stormwater quality control measures to retrofit an existing development with similar land uses as the new development or land uses associated with comparable or higher stormwater runoff event mean concentrations (EMCs) than the new development. Off-site existing development retrofit projects may include use of retention-based stormwater quality control measures and/or biofiltration. Comparisons of EMCs for different land use types are based on published data from studies performed in Southern California.

Off-site retrofit of existing development must be approved by LACDPW and may require approval from the Regional Water Board Executive Officer, if petitioned by a third-party for review. If approval from the Regional Water Board Executive Officer is required, the project will be publicly-noticed on the Regional Water Board website for 30 days prior to approval.

Stormwater quality control measures at the off-site location must retain a volume at least equal to the mitigation volume (V_M), which is calculated according to the following equation:

$$V_M = 1.0 \times (SWQDv - V_R)$$

⁵ See the Water Quality Control Plan: Los Angeles Region, Basin Plan for the Coastal Watersheds of Los Angeles and Ventura Counties for information on hydrologic sub-watersheds.

Where:

V_M = Mitigation volume [ft³];

SWQDv = Stormwater quality design volume [ft³]; and

V_R = Volume of stormwater runoff reliably retained on-site [ft³].

In order to use retrofitting an existing development as an alternative compliance measure, the mitigation volume must be treated to reduce pollutants of concern prior to conveyance off-site (see below).

The project applicant may install a flow-through modular treatment system, including sand filters or other proprietary stormwater quality control measure with a demonstrated efficiency at least equivalent to a sand filter. However the project applicant must still verify that the project site adequately treats the pollutants of concern. The sizing of the flow-through stormwater quality control measure is based on a rainfall intensity of:

- 0.2 inches per hour; or
- The one-year, one-hour rainfall intensity as determined from the most recent Los Angeles County isohyetal map, whichever is greater.

Treatment of Pollutants of Concern

When implementing off-site alternative compliance measures, the project applicant is required to provide treatment to remove pollutants of concern for the portion of the SWQDv that is not reliably retained on-site. The pollutants of concern for a project site depend on the following factors:

- Project location;
- Land use and activities that have occurred on the project site in the past;
- Land use and activities that are likely to occur in the future; and
- Receiving water impairments.

The project applicant, in selecting and designing stormwater quality control measures for an alternative compliance measure, must consider the location of the project site within a watershed and the type of development that is being proposed. Additionally the project applicant must ensure that the project site does not cause or contribute to an exceedence of water quality standards at the downstream storm drain system outfall. When considering the type of development, the project applicant must use the following three-tiered approach to identify pollutants of concern at the project site and provide the list to LACDPW as part of the LID plan:

- Step 1: Address pollutants of concern based on land use;
- Step 2: Address pollutants of concern based on receiving water impairments; and
- Step 3: Address pollutants of concern based on watershed management areas.

Pollutants of Concern from Land Use

As land use activities and site design practices evolve, particularly with increased incorporation of stormwater quality control measures, characteristic stormwater runoff concentrations and pollutants of concern from various land use types are also likely to change. At a minimum for proposed projects implementing off-site alternative compliance measures, the project applicant must address the pollutants of concern presented in Table 7-3 based on land use and show that it will meet all water quality benchmarks presented in

Table 7-2 prior to conveyance of the portion of the SWQDv that is not reliably retained on-site from the project site.

Table 7-2. Water Quality Benchmarks Applicable to Stormwater Runoff Conveyed to Off-Site Mitigation Sites

Pollutant	Effluent Concentration
Suspended solids	14 mg/L
Total phosphorus	0.13 mg/L
Total nitrogen	1.28 mg/L
Total Kjeldahl nitrogen (TKN)	1.09 mg/L
Cadmium, total	0.3 µg/L
Copper, total	6 µg/L
Chromium, total	2.8 µg/L
Lead, total	2.5 µg/L
Zinc, total	23 µg/L

Low Impact Development Standards Manual

Table 7-3. Typical Pollutants of Concern by Land Use ⁽¹⁾

Land Use	Pollutants of Concern ⁽²⁾								
	Suspended Solids	Total Phosphorus	Total Nitrogen	Total Kjeldahl Nitrogen	Cadmium, Total	Chromium, Total	Copper, Total	Lead, Total	Zinc, Total
High Density Single Family Residential	X	X			(4)	(4)	X	X	X
Multi-Family Residential	X				(4)	(4)	X		X
Mixed Residential	X	X	X		(4)	(4)	X	X	X
Commercial	X	X	X	X	(4)	(4)	X	X	X
Industrial	X	X	X	X	(4)	(4)	X	X	X
Critical Facilities ⁽³⁾	X	(4)	(4)	(4)	(4)	(4)	X	X	X
Transportation (streets, roads)	X	X	X	X	(4)	(4)	X	X	X
Institutional (educational facilities)	X				(4)	(4)	X		X

⁽¹⁾ Adapted from Table A-3 of the *Technical Manual for Stormwater Best Management Practices in the County of Los Angeles* (February 2004) and the Southern California Coastal Water Research Project Land Use Specific Storm Water Monitoring Data. X = exceedance of “standard” by observed median/average concentration; blank = no exceedance of “standard” by observed median/average concentration.

⁽²⁾ Derived from Table 11 of the 2012 Los Angeles County MS4 Permit (page 104).

⁽³⁾ Critical facilities include automobile dismantling (SIC 50xx), automobile repair (SIC 75xx), metal fabrication (SIC 34xx), motor freight (SIC 42xx), automobile dealerships (SIC 55xx), chemical manufacturing (SIC 28xx), and machinery manufacturing (SIC 35xx).

⁽⁴⁾ No available data to determine if these pollutants of concern originate from this land use. Pollutant is assumed to be produced by this land use unless otherwise proven by the project applicant.

Pollutants of Concern from Receiving Water Impairment

The CWA requires that states adopt water quality standards for receiving waters. Water quality standards consist of designated beneficial uses for a particular receiving water (i.e., wildlife habitat, agricultural supply), along with water quality criteria necessary to support those beneficial uses. Water quality criteria are prescribed concentrations or levels of pollutants (i.e., lead, suspended solids, bacteria) or narrative statements that represent the quality of water that supports a particular use. Applicable water quality standards for surface and groundwater in the County are outlined in the Basin Plan. Numeric water quality criteria for surface waters are also promulgated in the California Toxics Rule, which was adopted in May 2000 by USEPA. Additionally, drinking water standards from Title 22 of the California Code of Regulations may apply.

When receiving water monitoring data indicates that a water quality criterion for a pollutant is exceeded, the receiving water is classified as impaired and placed on the *CWA Section 303(d) List of Water Quality Limited Segments Requiring TMDLs* (303(d) List). In order to address the impairment, a TMDL is developed for the pollutant(s) causing the impairment. The purpose of each TMDL is to limit the amount of pollutant(s) that may be discharged to the receiving water from all sources (i.e., stormwater runoff, wastewater, agriculture). Lists of adopted TMDLs and 303(d)-listed Los Angeles County water bodies are available at the following web addresses:

- Adopted TMDLs:
http://www.waterboards.ca.gov/losangeles/water_issues/programs/tmdl/
- 303(d)-listed water bodies:
http://www.swrcb.ca.gov/rwqcb4/water_issues/programs/303d_list.shtml

A map of the TMDLs that are in effect, as of October 2013, for water bodies in the County is presented in Appendix A.

If a proposed project is located where stormwater runoff drains to a TMDL-listed or 303(d)-listed water body, the project applicant must provide an explanation of how the proposed project will address the pollutants of concern. This includes both structural stormwater quality control measures and non-structural BMPs (i.e., trash cans, signage).

Pollutants of Concern from Watershed Management Areas

Attachment G of the 2012 MS4 Permit contains non-stormwater runoff and municipal action levels for pollutants of concern by watershed management areas. If a proposed project is located in one of the listed watershed management areas, the project applicant must also address the pollutant(s) of concern identified in Appendix B, in addition to pollutants of concern based on land use and, if applicable, pollutants of concern based on receiving water impairment.

SECTION 8. HYDROMODIFICATION REQUIREMENTS

8.1. Introduction

All Designated and Non-Designated projects located within natural drainage systems that have not been improved (e.g., channelized or armored with concrete, shotcrete, or rip-rap) or drainage systems that are tributary to a natural drainage system, except as excluded, are required to implement hydromodification controls. The project must fully mitigate off-site drainage impacts caused by hydromodification and changes in water quality, flow velocity, flow volume, and depth/width of flow. The following hydromodification control criteria must be implemented by project applicants to control potential adverse impacts of changes in hydrology that may result from projects located within natural drainage systems.

8.2. Exemptions to Hydromodification Requirements

Projects may be exempt from implementation of hydromodification control measures where assessments of downstream channel conditions and proposed discharge hydrology indicate that adverse hydromodification effects to beneficial uses of natural drainage systems are unlikely. The Director of Public Works may grant exemptions for requiring hydromodification control measures for the following types of projects:

- The replacement, maintenance, or repair of an existing permitted publicly-maintained flood control facility, storm drain, or transportation network;
- Redevelopment of a previously developed site in an urbanized area that does not increase the effective impervious area or decrease the infiltration capacity of pervious areas compared to the pre-project conditions;
- Projects that have any increased discharge directly or through a storm drain to a sump, lake, area under tidal influence, into a waterway that has an estimated hundred (100)-year peak flow of 25,000 cfs or more, or other receiving water that is not susceptible to hydromodification impacts;
- Projects that discharge directly or through a storm drain into concrete or otherwise engineered channel (i.e., channelized or armored with rip-rap, shotcrete), which, in turn, discharge into receiving water that is not susceptible to hydromodification impacts.
- Non-Designated Project disturbing less than 1 acre or creating less than 10,000 square feet of new impervious area; or
- Single-family homes that incorporate LID BMPs in accordance with the LID Standards Manual.

8.3. Frequency Analyses

Projects required to analyze for hydromodification impacts must conduct hydrology and hydraulic frequency analyses for LID, 2-, 5-, 10-, 25-, and 50-year storm events per the LACDPW Hydraulic and Hydrology manuals. The frequency analyses, which analyze

changes in flow velocity, flow volume, and depth/width of flow for all natural drainage systems using HEC-RAS, are used to demonstrate compliance with hydromodification requirements and identify drainage impacts on off-site property.

8.4. Sediment Analysis

A sediment transport analysis is required for any project tributary to a natural drainage system with a capital flood flow rate greater than 5,000 cubic feet per second (cfs). The sediment transport analyses should be conducted using HEC-RAS, SAMS, or HEC-6 to determine long-term impacts of streambed accretion and degradation of these natural drainage systems.

8.5. Infeasibility of Hydromodification Implementation

If a project applicant is unable to show there will be no impacts from the post-construction condition using the frequency analyses, the project applicant must obtain Drainage Acceptance Letters from the owner of every impacted downstream property. An example Drainage Acceptance Letter is provided in Appendix G. If Drainage Acceptance Letters cannot be obtained, the project applicant must disclose in the California Environmental Quality Act (CEQA) document a significant unmitigated downstream drainage impact, and a Statement of Overriding Consideration must be prepared to justify, if possible, the project's impact on the environment.

In addition to obtaining Drainage Acceptance Letters, the project applicant must also comply with one of the following alternative requirements:

- For projects disturbing an area greater than 1 acre, but less than 50 acres within natural drainage systems, one of the following demonstrations must be shown:
 - The project is designed to retain on-site, through infiltration, evapotranspiration, and/or harvest and use, the volume of stormwater runoff from the 95th percentile, 24-hour storm; or
 - The stormwater runoff flow rate, volume, velocity, and duration for the post-development condition does not exceed the pre-development condition for the 2-year, 24-hour rainfall event; or
 - The Erosion Potential (E_p) in the receiving water channel will approximate 1, as determined by a Hydromodification Analysis Study and the equation presented in the following section. Alternatively, other work index equations to calculate E_p may be used with approval from the Executive Officer of the Regional Water Board.
- For projects disturbing an area 50 acres or more within natural drainage systems, one of the following demonstrations must be shown:
 - The site infiltrates on-site at least the stormwater runoff from a 2-year, 24-hour storm event; or

- The stormwater runoff flow rate, volume, velocity, and duration for the post-construction development condition does not exceed the pre-development condition for the 2-year, 24-hour rainfall events; or
- The E_p in the receiving water channel will approximate 1, as determined by a Hydromodification Analysis Study and the equations presented in the following section. Alternatively, other work index equations to calculate E_p may be used with approval from the Executive Officer of the Regional Water Board.

Erosion Potential Determination

The total effective work done on the channel boundary is derived and used as a metric to predict the likelihood of channel adjustment given watershed and stream hydrologic and geomorphic variables. The index under post-development conditions is compared to the index under pre-development conditions and expressed as a ratio called the erosion potential (E_p). The effective work index (W) can be computed using different methodologies, including simplistic work equations, material-specific sediment transport equations, or more complex functions based on site-calibrated sediment rating curves. One such work equation, which represents the total work done on the channel boundary, is the following:

$$W = \sum_{i=1}^n (\tau_i - \tau_c)^{1.5} \times V \times \Delta t_i$$

Where:

W_u = Effective work index;

τ_c = Critical shear stress that initiates bed mobility or erodes the weakest bank layer;

τ_i = Applied hydraulic shear stress;

Δt = Duration of flow (hr);

V = Mid-channel flow velocity; and

n = Length of flow record.

The effective work index for the presumed stable stream channels under pre-development conditions is compared to the stable and unstable channels under post-development conditions. The comparison is expressed as the erosion potential according to the following equation (McRae [1992, 1996]):

$$E_p = \frac{W_{post}}{W_{pre}}$$

Where:

E_p = Erosion potential;

W_{post} = Work index estimate for post-development condition; and

W_{pre} = Work index estimate for pre-development condition.

SECTION 9. STORMWATER QUALITY CONTROL MEASURE MAINTENANCE

Continued effectiveness of stormwater quality control measures specified in the LID Standards Manual depends on on-going inspection and maintenance. All publicly-maintained stormwater quality control measures must have easements for access and maintenance or be in lots dedicated to the County in fee title. To ensure that such maintenance is provided, LACDPW may require the submittal of a Maintenance Plan and execution of a Maintenance Agreement with the owner/operator of stormwater quality control measures. The property owner or his/her designee is responsible for complying with the Maintenance Agreement. Requirements for the Maintenance Plan and Maintenance Agreement are presented and discussed in this section. Example Maintenance Agreements are provided in Appendix H.

9.1. Maintenance Plan Requirements

A Maintenance Plan may be required as part of the project application submittal to LACDPW. The Maintenance Plan must address the following items:

- Operation plan and schedule, including a site map;
- Maintenance and cleaning activities and schedule;
- Equipment and resource requirements necessary to operate and maintain stormwater quality control measure; and
- Responsible party for operation and maintenance.

This section identifies basic information that must be included in a Maintenance Plan. Refer to Appendix E for individual stormwater quality control measure-specific maintenance requirements.

Site Map

- Provide a site map showing boundaries of the site, acreage, and drainage patterns/contour lines. Show each discharge location from the project site and any drainage flowing onto the site. Distinguish between pervious and impervious surfaces on the map.
- Identify locations of existing and proposed storm drain facilities, private sanitary sewer systems, and grade breaks for purposes of pollution prevention.
- With a legend, identify locations of expected sources of pollution generation (e.g., outdoor work and storage areas, heavy traffic areas, delivery areas, trash enclosures, fueling areas, industrial clarifiers, and wash-racks). Identify any areas having contaminated soil or where pollutants are stored or have been stored/disposed of in the past.
- With a legend, indicate types and locations of stormwater quality control measures that will be built to permanently control stormwater pollution, including

Global Positioning System X and Y coordinates. Distinguish between pollution prevention, treatment, sewer diversion, and containment devices.

Baseline Descriptions

- List property owners and persons responsible for operation and maintenance of the on-site stormwater quality control measures. Include phone numbers and addresses.
- Identify the intended method of funding (i.e., homeowners association fees) for operation, inspection, routine maintenance, and upkeep of stormwater quality control measures.
- List all permanent stormwater quality control measures. Provide a brief description of each stormwater quality control measure and, if appropriate, fact sheets or additional information.
- As appropriate for each stormwater quality control measure, provide:
 - A written description and checklist of all maintenance and waste disposal activities that will be performed. Distinguish between the maintenance appropriate for a 2-year establishment period and expected long-term maintenance. For example, maintenance requirements for vegetation in a constructed wetland may be more intensive during the first few years until the vegetation is established. The post-establishment maintenance plan must address maintenance needs (e.g., pruning, irrigation, weeding) for a larger, more stable system. Include maintenance performance procedures for facility components that require relatively unique maintenance knowledge, such as specific plant removal/replacement, landscape features, or constructed wetland maintenance. These procedures must provide sufficient detail to a person unfamiliar with maintenance to perform the activity or identify the specific skills or knowledge to perform and document the maintenance.
 - A description of site inspection procedures and documentation system, including recordkeeping and retention requirements.
 - An inspection and maintenance schedule, preferably in the form of a table or matrix, for each activity for all facility components. The schedule must show how it will satisfy the specified level of performance and how maintenance/inspection activities relate to storm events and seasonal issues.
 - Identification of equipment and materials required to perform maintenance.
 - As appropriate, list all housekeeping procedures for prohibiting illicit discharges or potential illicit discharges to the storm drain system. Identify housekeeping BMPs that reduce maintenance of stormwater quality control measures.

Spill Plan

- Provide emergency notification procedures (phone and agency/persons to contact).
- As appropriate for site, provide emergency containment and cleaning procedures.
- Note downstream receiving waters, wetlands, or SEAs that may be affected by spills or chronic untreated discharges.
- As appropriate, create an emergency sampling procedure for spills. Emergency sampling can protect the property owner from erroneous liability for downstream receiving area cleanups.

Facility Changes

- Operational or facility conditions or changes that significantly affect the character or quantity of pollutants discharging into the stormwater quality control measures may require modifications to the Maintenance Plan and/or additional stormwater quality control measures.

Training

- Identify appropriate persons to be properly trained and assure documentation of training. Training should include:
 - Good housekeeping procedures defined in the Maintenance Plan;
 - Proper maintenance of all pollution mitigation devices;
 - Identification and cleanup procedures for spills and overflows;
 - Large-scale spill or hazardous material response; and
 - Safety concerns when maintaining devices and cleaning spills.

Basic Inspection and Maintenance Activities

- Create and maintain on-site, a log for inspector names, dates, and stormwater quality control measure to be inspected and maintained. Provide a checklist for each inspection and maintenance category.
- Perform and document annual testing of any mechanical or electrical devices prior to wet weather.
- Report any significant changes in stormwater quality control measures to the site management. As appropriate, assure mechanical devices are working properly and/or landscaped plants are irrigated and nurtured to promote thick growth.
- Note any significant maintenance requirements due to spills or unexpected discharges.

- As appropriate, perform maintenance and replacement as scheduled or as needed in a timely manner to assure stormwater quality control measures are performing as designed and approved.
- Assure unauthorized low-flow discharges from the property do not bypass stormwater quality control measures.

Perform an annual assessment of each pollution-generating operation and its associated stormwater quality control measures to determine if any part of the pollution reduction train can be improved. Annual assessment reports must be submitted to LACDPW.

Revisions to Pollution Mitigation Measures

- If future correction or modification of past stormwater quality control measures or procedures is required, the owner must obtain approval from LACDPW prior to commencing any work. Corrective measures or modifications must not cause discharges to bypass or otherwise impede existing stormwater quality control measures.

Funding

- All publicly-maintained stormwater quality control measures must have a funding mechanism (i.e., Drainage Benefit Assessment Area) in place prior to transfer.

9.2. Maintenance Agreement

Verification of maintenance provisions is required for all stormwater quality control measures. If required, verification, at a minimum, must include:

- The owner/developer's signed statement accepting responsibility for inspection and maintenance until the responsibility is legally transferred. An example Owners Certification Statement is provided in Appendix G; and either
 - A signed statement from the public entity assuming responsibility for stormwater quality control measure inspection and maintenance and certifying that it meets all design standards; or
 - Written conditions in the sales or lease agreement that require the recipient to assume responsibility for inspection and maintenance activities and to conduct a maintenance inspection at least once a year; or
 - Written text in project conditions, covenants, and restrictions for residential properties that assign maintenance responsibilities to a Home Owners Association for inspection and maintenance of stormwater quality control measures; or
 - A legally enforceable maintenance agreement that assigns responsibility for inspection and maintenance of stormwater quality control measures to the owner/operator. A Maintenance Agreement with LACDPW must be executed by the owner/operator before occupancy of the project is approved.

APPENDIX **A**

Effective TMDLs for Water Bodies in Los
Angeles County (October 2013)



COUNTY OF LOS ANGELES MAJOR WATERSHEDS

and EFFECTIVE TOTAL MAXIMUM DAILY LOADS (as of October 2013)

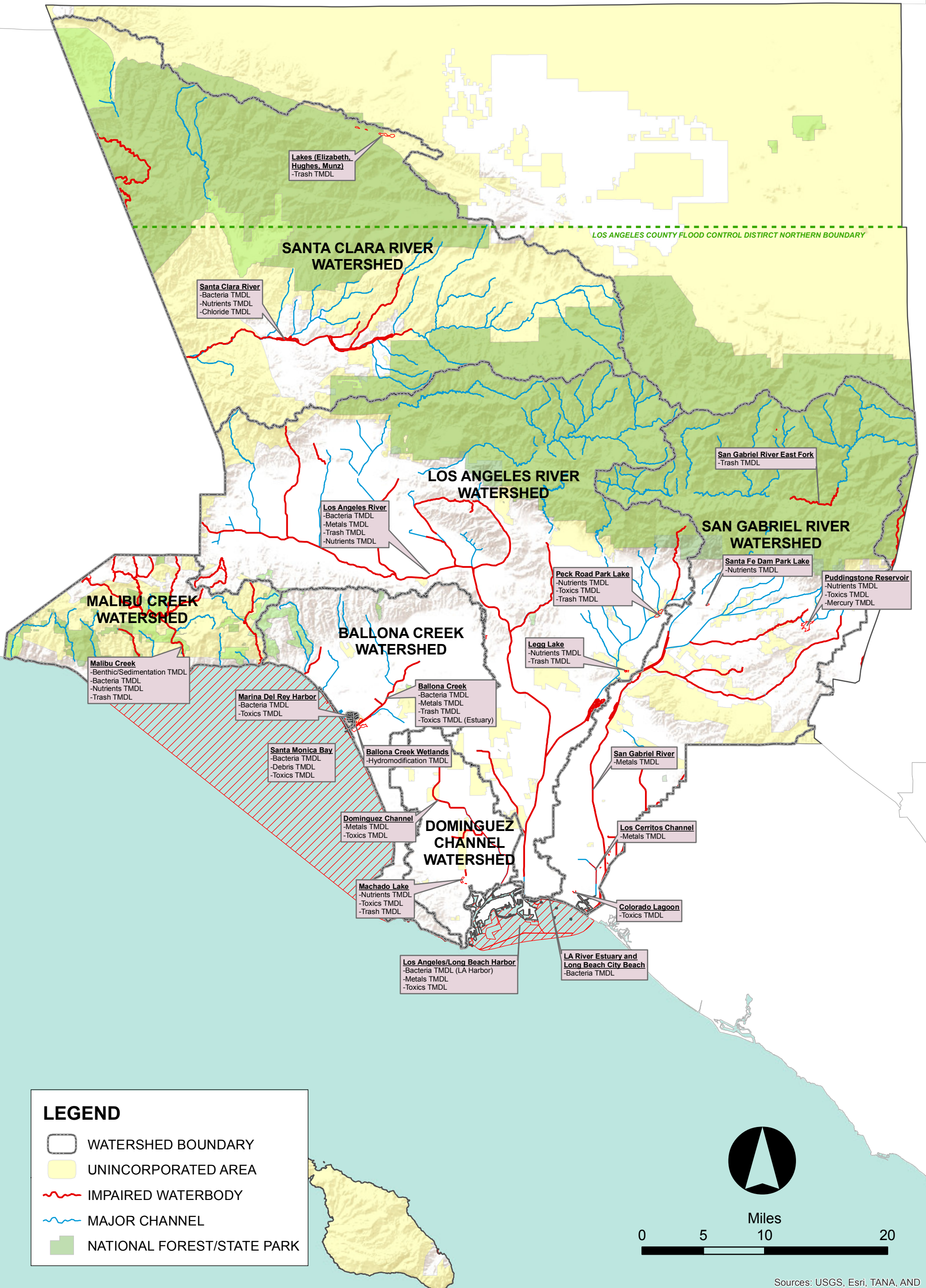

APPENDIX **B**

Tier 3 Pollutants of Concern

Appendix B: Tier 3 Pollutants of Concern

BALLONA CREEK WATERSHED MANAGEMENT AREA

Parameter	Parameter
pH	Cyanide, Total Recoverable
<i>E. coli</i> Bacteria	Copper, Total Recoverable
Total Coliform Bacteria ¹	Lead, Total Recoverable
Fecal Coliform Bacteria ¹	Mercury, Total Recoverable
Enterococcus Bacteria ¹	Selenium, Total Recoverable

¹ Apply only to discharges to the estuary and the ocean

DOMINGUEZ CHANNEL WATERSHED MANAGEMENT AREA

Parameter	Parameter
pH	Cyanide, Total Recoverable
<i>E. coli</i> Bacteria	Copper, Total Recoverable
Total Coliform Bacteria ¹	Lead, Total Recoverable
Fecal Coliform Bacteria ¹	Mercury, Total Recoverable
Enterococcus Bacteria ¹	Selenium, Total Recoverable

¹ Apply only to discharges to the estuary and the ocean

LOS ANGELES RIVER WATERSHED MANAGEMENT AREA

Parameter	Parameter
pH	Total Dissolved Solids
<i>E. coli</i> Bacteria	Turbidity
Total Coliform Bacteria ¹	Aluminum, Total Recoverable
Fecal Coliform Bacteria ¹	Cyanide, Total Recoverable
Enterococcus Bacteria ¹	Copper, Total Recoverable
Chloride	Mercury, Total Recoverable
Nitrite Nitrogen, Total (as N)	Selenium, Total Recoverable
Sulfate	

¹ Apply only to discharges to the estuary and the ocean

Appendix B: Tier 3 Pollutants of Concern

MALIBU CREEK WATERSHED MANAGEMENT AREA

Parameter	Parameter
<i>E. coli</i> Bacteria	Total Dissolved Solids
Cyanide, Total Recoverable	
Mercury, Total Recoverable	
Selenium, Total Recoverable	
Sulfate	

SAN GABRIEL RIVER WATERSHED MANAGEMENT AREA

Parameter	Parameter
pH	Cyanide, Total Recoverable
<i>E. coli</i> Bacteria	Cadmium, Total Recoverable
Total Coliform Bacteria ¹	Copper, Total Recoverable
Fecal Coliform Bacteria ¹	Lead, Total Recoverable
Enterococcus Bacteria ¹	Mercury, Total Recoverable
Chloride	Nickel, Total Recoverable
Nitrate Nitrogen, Total (as N)	Selenium, Total Recoverable
Sulfate	Silver, Total Recoverable
Total Dissolved Solids	Zinc, Total Recoverable
Aluminum, Total Recoverable	

¹ Apply only to discharges to the estuary and the ocean

SANTA CLARA RIVER WATERSHED AREA (LA County portion only)

Parameter	Parameter
<i>E. coli</i> Bacteria	Aluminum, Total Recoverable
Chloride	Cyanide, Total Recoverable
Sulfate	Copper, Total Recoverable
Total Dissolved Solids	Mercury, Total Recoverable
Methylene Blue Active Substances	Selenium, Total Recoverable

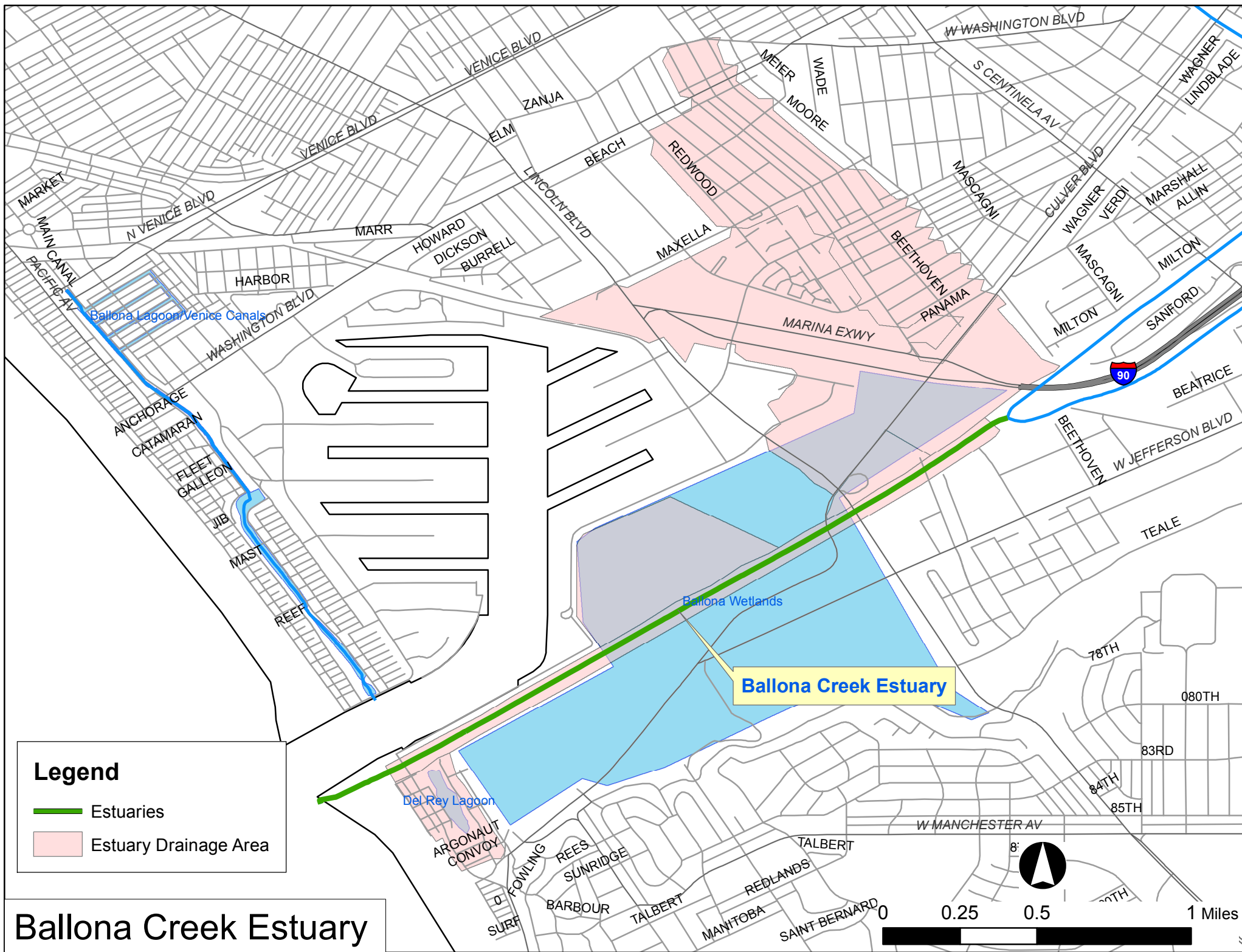

Legend

- Estuaries
- Estuary Drainage Area

Ballona Creek Estuary

Dominguez Channel Estuary, Los Angeles River Estuary and San Gabriel River Estuary

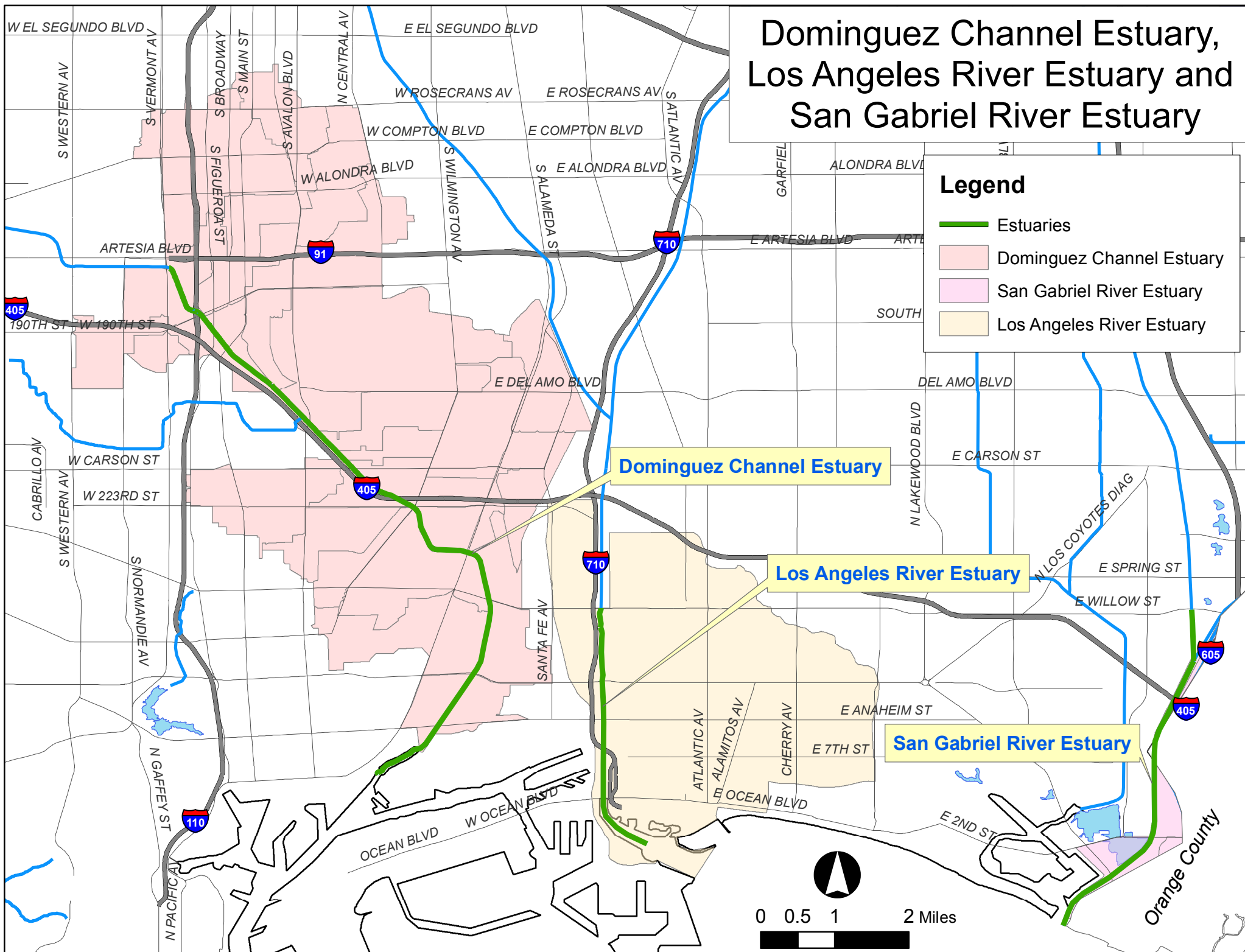

APPENDIX C

Geotechnical Information and References



HYDROLOGY MANUAL



Los Angeles County Department of Public Works
January 2006

APPENDIX C

Soil Type & Runoff Coefficient Data

Soil Identification Table

Number	Name	Original Name
2	ALTAMONT CLAY LOAM	A
3	CHINO SILT LOAM	CS-1
4	DIABLO CLAY LOAM	DY
5	HANFORD FINE SANDY LOAM	HF
6	HANFORD FINE SANDY LOAM	HF-1
7	HANFORD GRAVELLY SANDY LOAM	HG
8	HANFORD SILT LOAM	HN
9	MONTEZUMA CLAY ADOBE	M
10	OAKLEY FINE SAND	OS
11	PLACENTIA LOAM	PL
12	RAMONA CLAY LOAM	RC- 1
13	RAMONA LOAM	RO
14	RAMONA SANDY LOAM	RS
15	TUJUNGA FINE SANDY LOAM	TF
16	YOLO LOAM	Y
17	YOLO CLAY LOAM	YC
18	YOLO FINE SANDY LOAM	YF
19	YOLO GRAVELLY SANDY LOAM	YG
20	YOLO SANDY LOAM	YS
21	SANTA MONICA MOUNTAINS	SMM-1
22	SANTA MONICA MOUNTAINS	SMM-2
23	SANTA MONICA MOUNTAINS	SMM-3
24	SANTA MONICA MOUNTAINS	SMM-4
25	SANTA MONICA MOUNTAINS	SMM-5
26	SANTA MONICA MOUNTAINS	SMM-6
27	SANTA MONICA MOUNTAINS	SMM-7
28	SANTA MONICA MOUNTAINS	SMM-8
29	SANTA MONICA MOUNTAINS	SMM-9
30	SANTA MONICA MOUNTAINS	SMM-10
31	SANTA MONICA MOUNTAINS	SMM- 11
32	SANTA MONICA MOUNTAINS	SMM-12
33	SANTA MONICA MOUNTAINS	SMM-13
34	SANTA MONICA MOUNTAINS	SMM-14
35	SANTA MONICA MOUNTAINS	SMM-15
36	SANTA MONICA MOUNTAINS	SMM-16
37	SANTA MONICA MOUNTAINS	SMM- 17
38	SANTA MONICA MOUNTAINS	SMM- 18

Number	Name	Original Name
39	SANTA MONICA MOUNTAINS	SMM-19
40	SANTA MONICA MOUNTAINS	SMM-20
41	SANTA MONICA MOUNTAINS	SMM-21
42	SANTA MONICA MOUNTAINS	SMM-22
43	SANTA MONICA MOUNTAINS	SMM- 23
44	SANTA MONICA MOUNTAINS	SMM-24
45	SANTA MONICA MOUNTAINS	SMM-25
46	UPPER LOS ANGELES RIVER	ULAR-1
47	UPPER LOS ANGELES RIVER	ULAR-3
48	UPPER LOS ANGELES RIVER	ULAR-5
49	UPPER LOS ANGELES RIVER	ULAR-6AB
50	UPPER LOS ANGELES RIVER	ULAR-6 CD
51	UPPER LOS ANGELES RIVER	ULAR-6EF
52	UPPER LOS ANGELES RIVER	ULAR-7A
53	UPPER LOS ANGELES RIVER	ULAR-7B
54	UPPER LOS ANGELES RIVER	ULAR-7CD
55	UPPER LOS ANGELES RIVER	ULAR-8
56	UPPER LOS ANGELES RIVER	ULAR-9A
57	UPPER LOS ANGELES RIVER	ULAR-9B
58	UPPER LOS ANGELES RIVER	ULAR-9C
59	UPPER LOS ANGELES RIVER	ULAR-9D
60	UPPER LOS ANGELES RIVER	ULAR-9E
61	UPPER LOS ANGELES RIVER	ULAR-10A
62	UPPER LOS ANGELES RIVER	ULAR-10B
63	UPPER LOS ANGELES RIVER	ULAR-11
64	UPPER LOS ANGELES RIVER	ULAR-12
65	UPPER LOS ANGELES RIVER	ULAR-13
66	UPPER LOS ANGELES RIVER	ULAR-14
67	UPPER LOS ANGELES RIVER	ULAR-15
68	UPPER LOS ANGELES RIVER	ULAR-16
69	UPPER LOS ANGELES RIVER	ULAR-17
70	UPPER LOS ANGELES RIVER	ULAR-18
71	UPPER LOS ANGELES RIVER	ULAR-19
72	UPPER LOS ANGELES RIVER	ULAR-20A
73	UPPER LOS ANGELES RIVER	ULAR-20B
74	UPPER LOS ANGELES RIVER	ULAR-21
75	UPPER LOS ANGELES RIVER	ULAR-22
76	UPPER LOS ANGELES RIVER	ULAR-23A

Number	Name	Original Name
77	UPPER LOS ANGELES RIVER	ULAR-23B
78	UPPER SAN GABRIEL RIVER	USGR-B
79	UPPER SAN GABRIEL RIVER	USGR-D
80	UPPER SAN GABRIEL RIVER	USGR-F
81	UPPER SAN GABRIEL RIVER	USGR-G-1
82	UPPER SAN GABRIEL RIVER	USGR-G-2
83	UPPER SAN GABRIEL RIVER	USGR-H
84	UPPER SAN GABRIEL RIVER	USGR-0
85	UPPER SAN GABRIEL RIVER	USGR-S
86	UPPER SAN GABRIEL RIVER	USGR-T
87	UPPER SAN GABRIEL RIVER	USGR-U
88	UPPER SAN GABRIEL RIVER	USGR-V
89	UPPER SAN GABRIEL RIVER	USGR-X
90	UPPER SAN GABRIEL RIVER	USGR-Y
91	SANTA CLARA RIVER	SCR-1-1
92	SANTA CLARA RIVER	SCR-1-2
93	SANTA CLARA RIVER	SCR-2
94	SANTA CLARA RIVER	SCR-2-1
95	SANTA CLARA RIVER	SCR-4
96	SANTA CLARA RIVER	SCR-4-1
97	SANTA CLARA RIVER	SCR-5
98	SANTA CLARA RIVER	SCR-6
99	SANTA CLARA RIVER	SCR-7
100	SANTA CLARA RIVER	SCR-8-1
101	SANTA CLARA RIVER	SCR-8-2
102	SANTA CLARA RIVER	SCR-8-3
103	SANTA CLARA RIVER	SCR-8-4
104	SANTA CLARA RIVER	SCR-8-5
105	SANTA CLARA RIVER	SCR-8-6
106	SANTA CLARA RIVER	SCR-8-7
107	SANTA CLARA RIVER	SCR-9
108	SANTA CLARA RIVER	SCR-9-1
109	SANTA CLARA RIVER	SCR-10
110	SANTA CLARA RIVER	SCR-C3211
111	SANTA CLARA RIVER	SCR-12
112	ANTELOPE VALLEY	AV-1
113	ANTELOPE VALLEY	AV-2
114	ANTELOPE VALLEY	AV-3

Number	Name	Original Name
115	ANTELOPE VALLEY	AV-4
116	ANTELOPE VALLEY	AV-5
117	ANTELOPE VALLEY	AV-6
118	ANTELOPE VALLEY	AV-7
119	ANTELOPE VALLEY	AV-8
120	ANTELOPE VALLEY	AV-9
121	ANTELOPE VALLEY	AV-10
122	ANTELOPE VALLEY	AV-12
123	ANTELOPE VALLEY	AV-12
124	ANTELOPE VALLEY	AV-13
125	ANTELOPE VALLEY	AV-14
126	ANTELOPE VALLEY	AV-15
127	ANTELOPE VALLEY	AV-16
128	ANTELOPE VALLEY	AV-17
129	ANTELOPE VALLEY	AV-18
130	ANTELOPE VALLEY	AV-19
131	ANTELOPE VALLEY	AV-20
132	ANTELOPE VALLEY	AV-21
133	ANTELOPE VALLEY	AV-22
134	ANTELOPE VALLEY	AV-23
135	LITTLE ROCK CREEK	LR-1
136	LITTLE ROCK CREEK	LR-2
137	LITTLE ROCK CREEK	LR-3-7
138	LITTLE ROCK CREEK	LR-4
139	LITTLE ROCK CREEK	LR-5
140	LITTLE ROCK CREEK	LR-6
141	LITTLE ROCK CREEK	LR-8-9
142	LITTLE ROCK CREEK	LR-10
143	LITTLE ROCK CREEK	LR-11
144	LITTLE ROCK CREEK	LR-12
145	LITTLE ROCK CREEK	LR-13
146	LITTLE ROCK CREEK	LR-14
147	LITTLE ROCK CREEK	LR-15
148	LITTLE ROCK CREEK	LR-16
149	LITTLE ROCK CREEK	LR-17
150	LITTLE ROCK CREEK	LR-18
151	LITTLE ROCK CREEK	LR-19
152	LITTLE ROCK CREEK	LR-20

Number	Name	Original Name
153	UPPER SAN GABRIEL RIVER	USGR-A
154	UPPER SAN GABRIEL RIVER	USGR-C
155	UPPER SAN GABRIEL RIVER	USGR-E
156	UPPER SAN GABRIEL RIVER	USGR-I
157	UPPER SAN GABRIEL RIVER	USGR-J
158	UPPER SAN GABRIEL RIVER	USGR-K
159	UPPER SAN GABRIEL RIVER	USGR-L-1
160	UPPER SAN GABRIEL RIVER	USGR-L-2
161	UPPER SAN GABRIEL RIVER	USGR-M
162	UPPER SAN GABRIEL RIVER	USGR-N
163	UPPER SAN GABRIEL RIVER	USGR-P
164	UPPER SAN GABRIEL RIVER	USGR-Q-1
165	UPPER SAN GABRIEL RIVER	USGR-Q-2
166	UPPER SAN GABRIEL RIVER	USGR-R
167	UPPER SAN GABRIEL RIVER	USGR-W
168	UPPER LOS ANGELES RIVER	ULAR-2A
169	UPPER LOS ANGELES RIVER	ULAR-2B
170	UPPER LOS ANGELES RIVER	ULAR-2C
171	UPPER LOS ANGELES RIVER	ULAR-2D
172	UPPER LOS ANGELES RIVER	ULAR-4

$C_D = (0.9 * IMP) + (1.0 - IMP) * C_U$
 Where: C_D = Developed Runoff Coefficient
 IMP = Proportion Impervious
 C_U = Undeveloped runoff coefficient



Los Angeles County Department of Public Works

RUNOFF COEFFICIENT CURVE
SOIL TYPE NO. 002

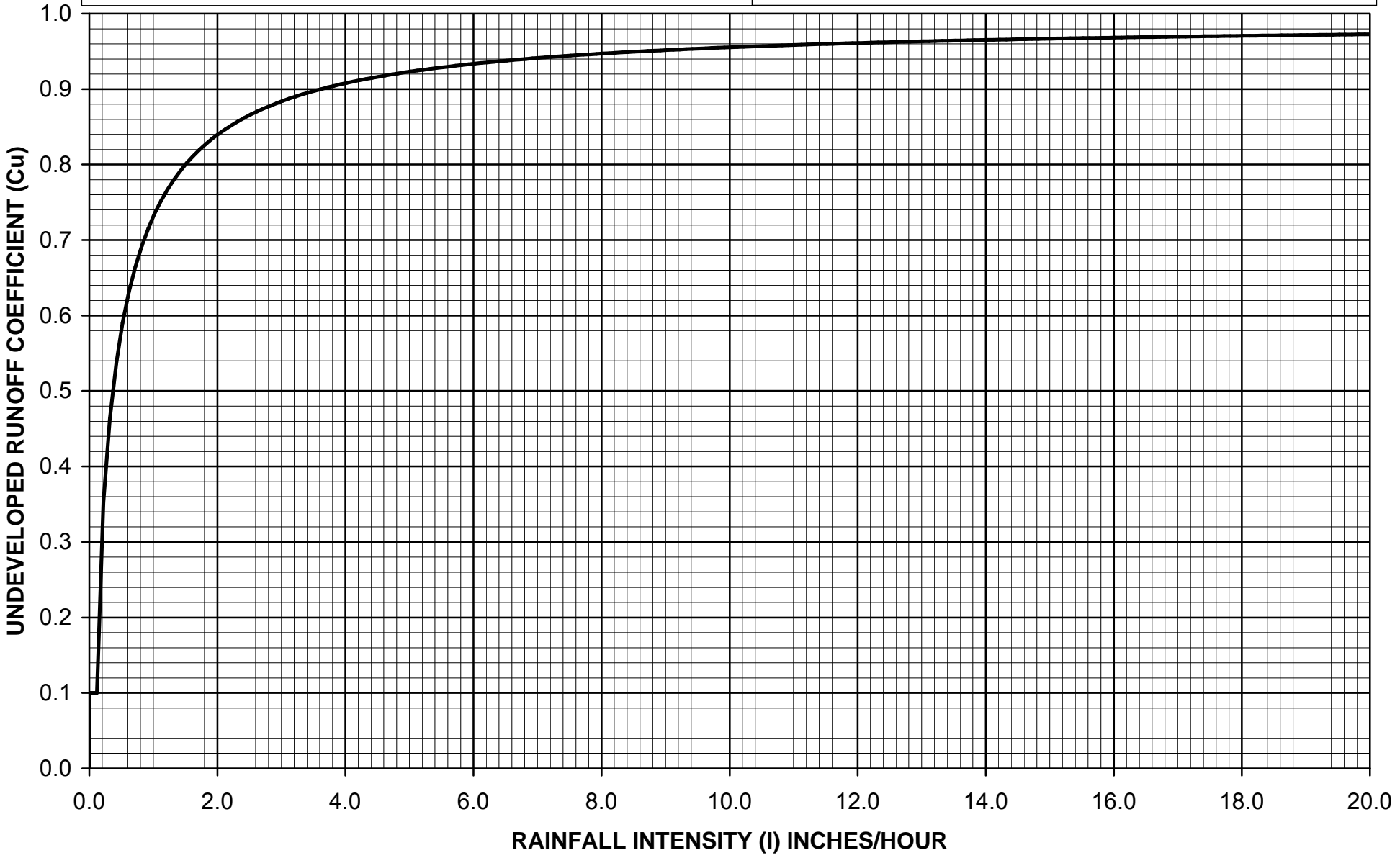

$$C_D = (0.9 * IMP) + (1.0 - IMP) * C_U$$

Where: C_D = Developed Runoff Coefficient

IMP = Proportion Impervious

C_U = Undeveloped runoff coefficient



Los Angeles County Department of Public Works

RUNOFF COEFFICIENT CURVE SOIL TYPE NO. 003

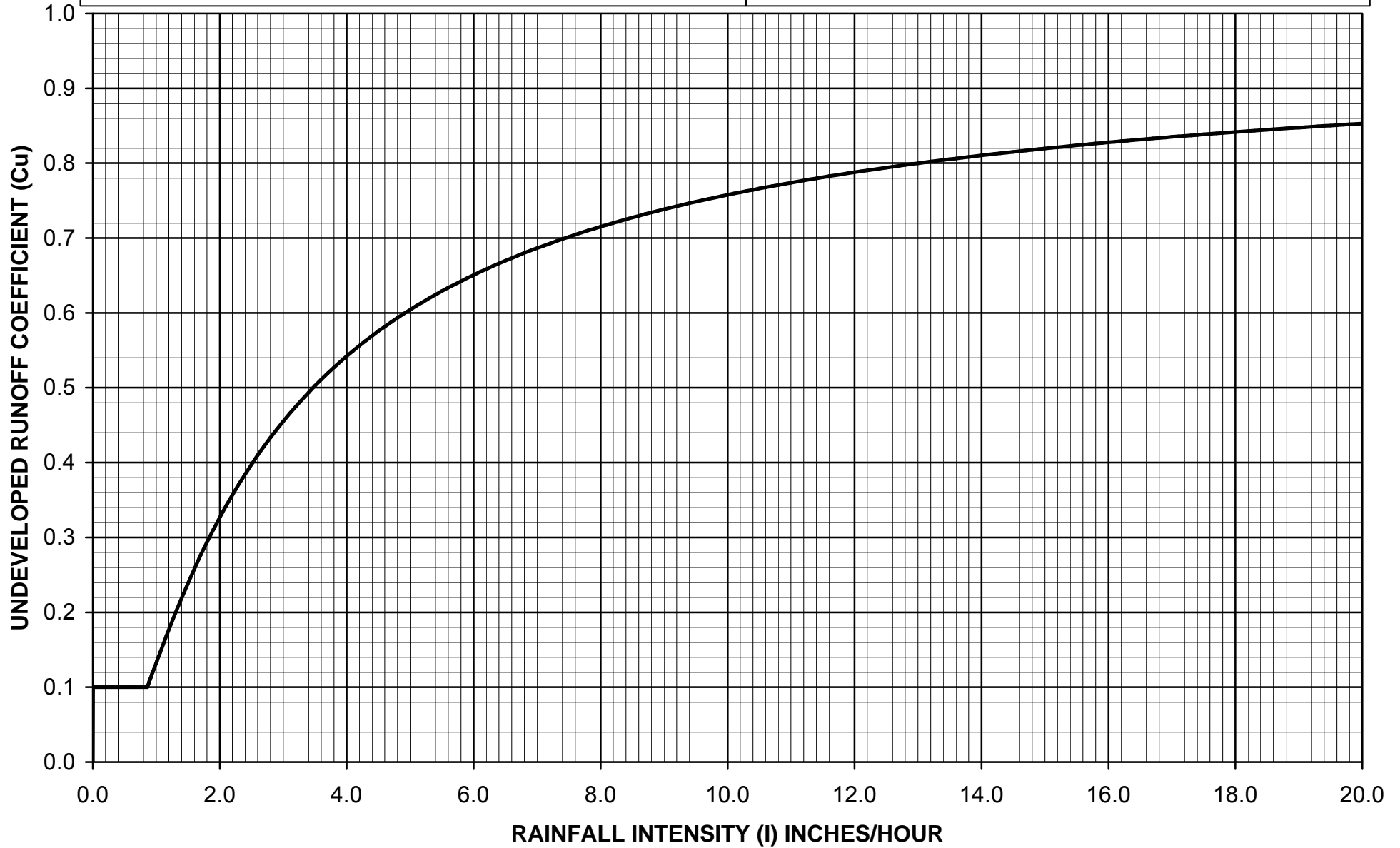

$$C_D = (0.9 * IMP) + (1.0 - IMP) * C_U$$

Where: C_D = Developed Runoff Coefficient

IMP = Proportion Impervious

C_U = Undeveloped runoff coefficient



Los Angeles County Department of Public Works

RUNOFF COEFFICIENT CURVE
SOIL TYPE NO. 004

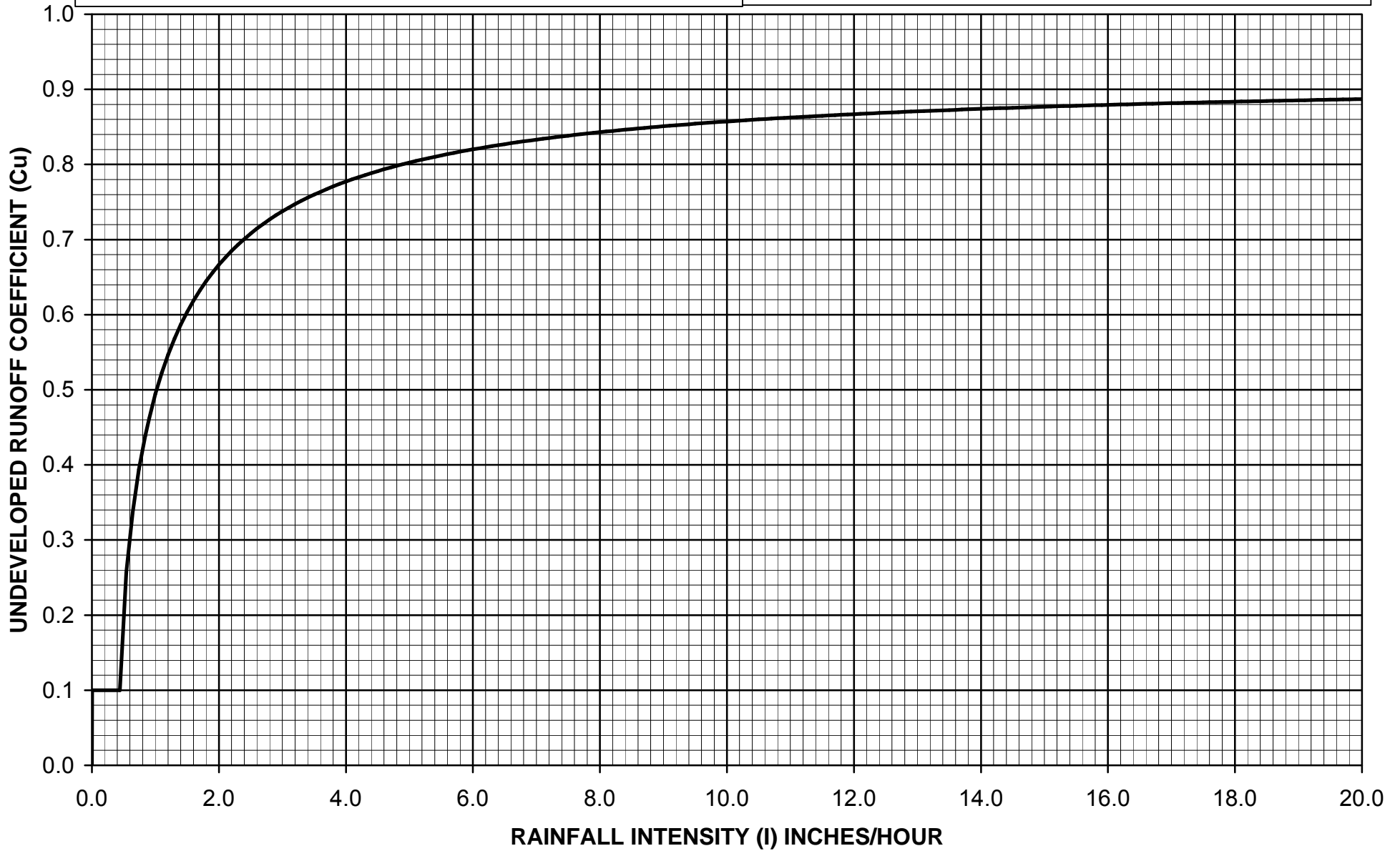

$$C_D = (0.9 * IMP) + (1.0 - IMP) * C_U$$

Where: C_D = Developed Runoff Coefficient
 IMP = Proportion Impervious
 C_U = Undeveloped runoff coefficient



Los Angeles County Department of Public Works

RUNOFF COEFFICIENT CURVE
SOIL TYPE NO. 005

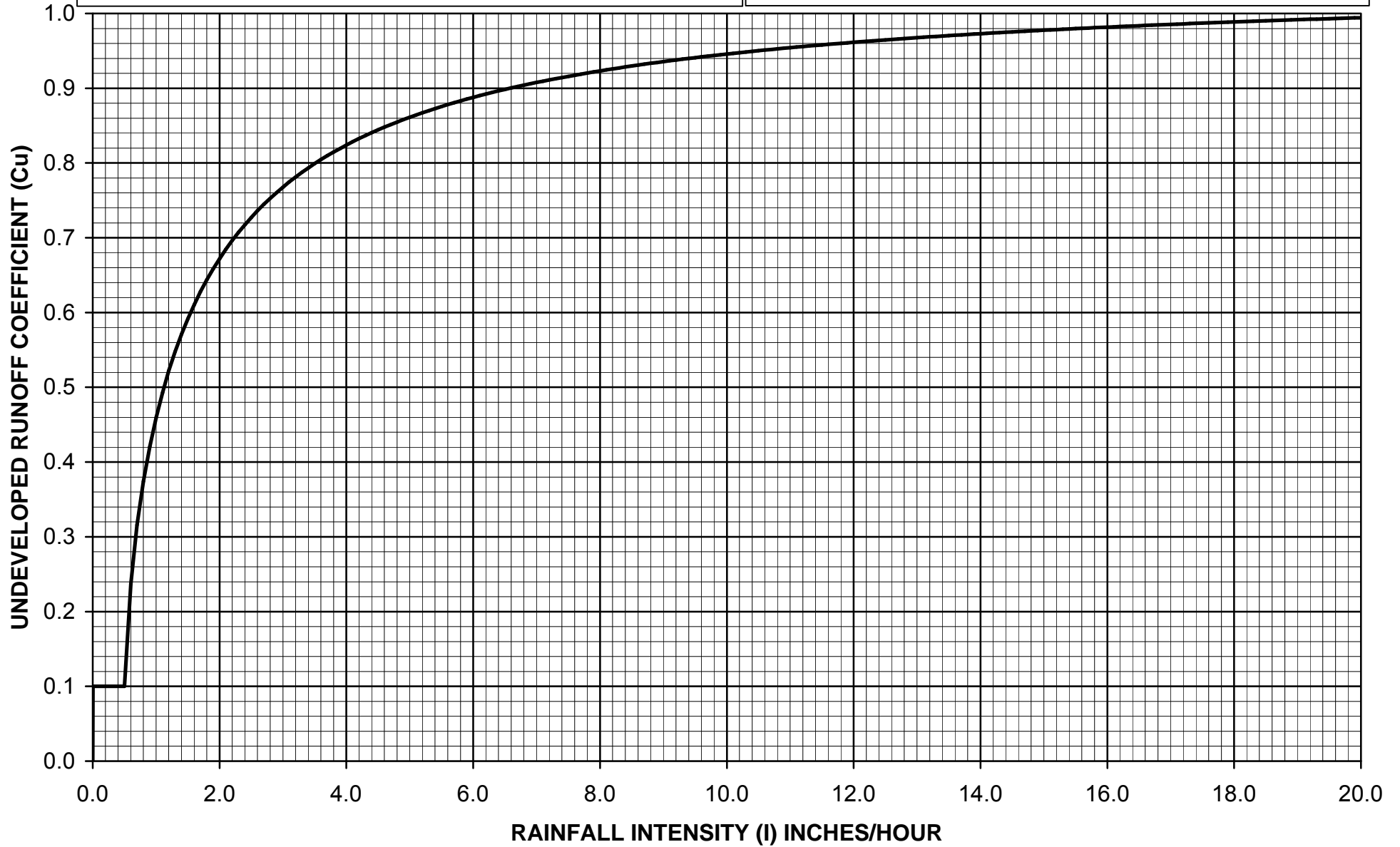

$$C_D = (0.9 * IMP) + (1.0 - IMP) * C_U$$

Where: C_D = Developed Runoff Coefficient
 IMP = Proportion Impervious
 C_U = Undeveloped runoff coefficient



Los Angeles County Department of Public Works

RUNOFF COEFFICIENT CURVE
SOIL TYPE NO. 006

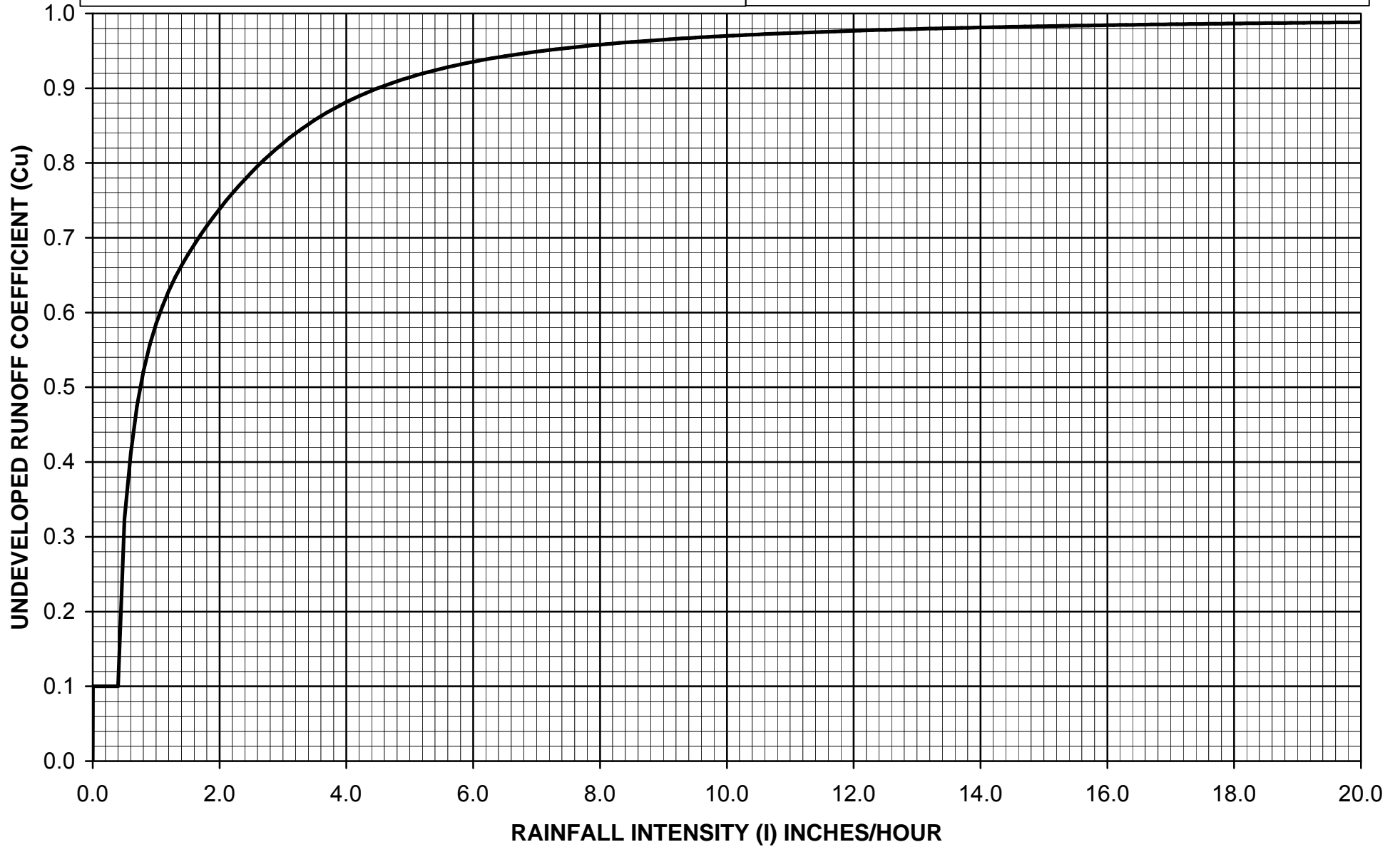

$C_D = (0.9 * IMP) + (1.0 - IMP) * C_U$
 Where: C_D = Developed Runoff Coefficient
 IMP = Proportion Impervious
 C_U = Undeveloped runoff coefficient



Los Angeles County Department of Public Works

RUNOFF COEFFICIENT CURVE
SOIL TYPE NO. 007

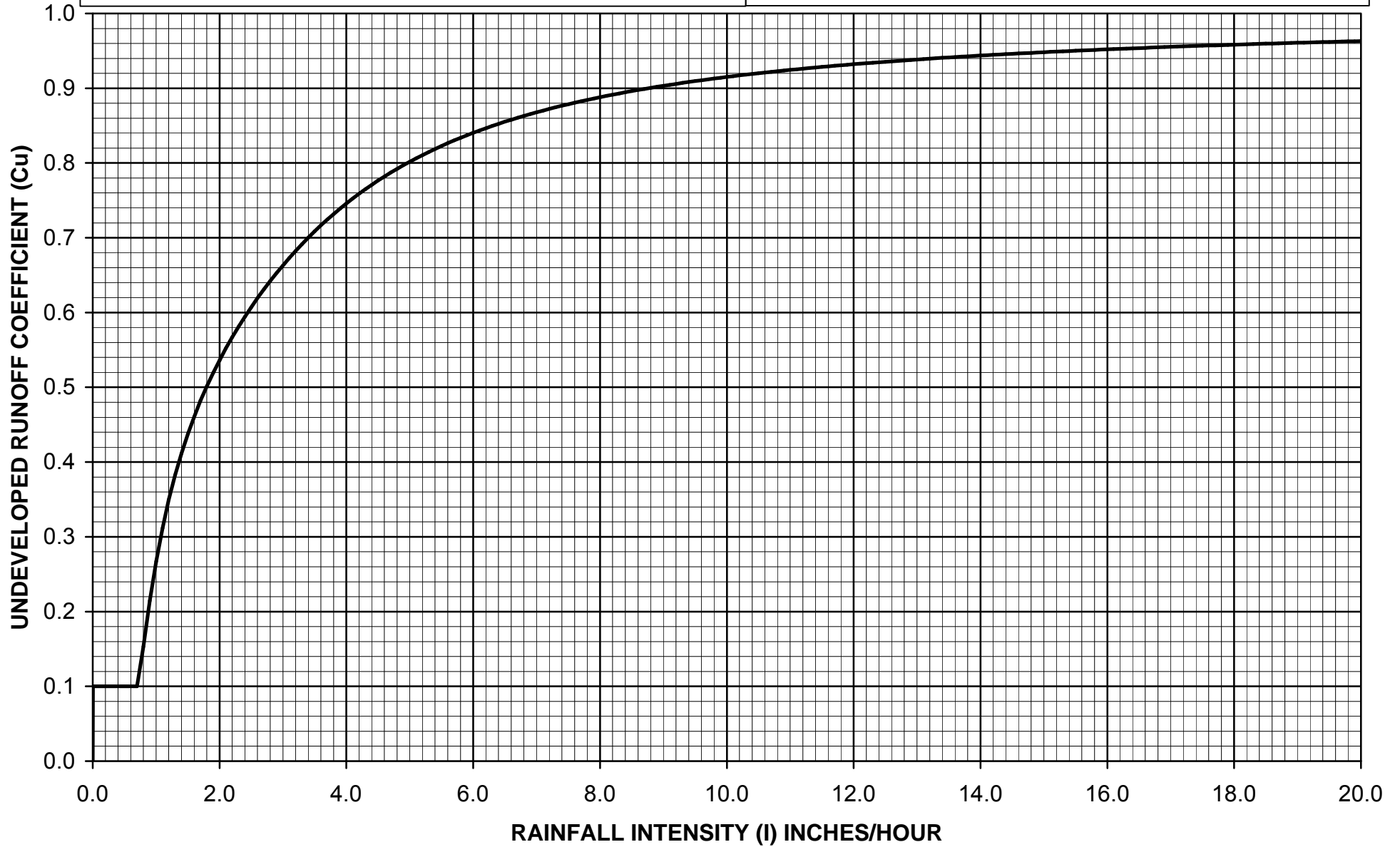

$$C_D = (0.9 * IMP) + (1.0 - IMP) * C_U$$

Where: C_D = Developed Runoff Coefficient
 IMP = Proportion Impervious
 C_U = Undeveloped runoff coefficient



Los Angeles County Department of Public Works

RUNOFF COEFFICIENT CURVE
SOIL TYPE NO. 008

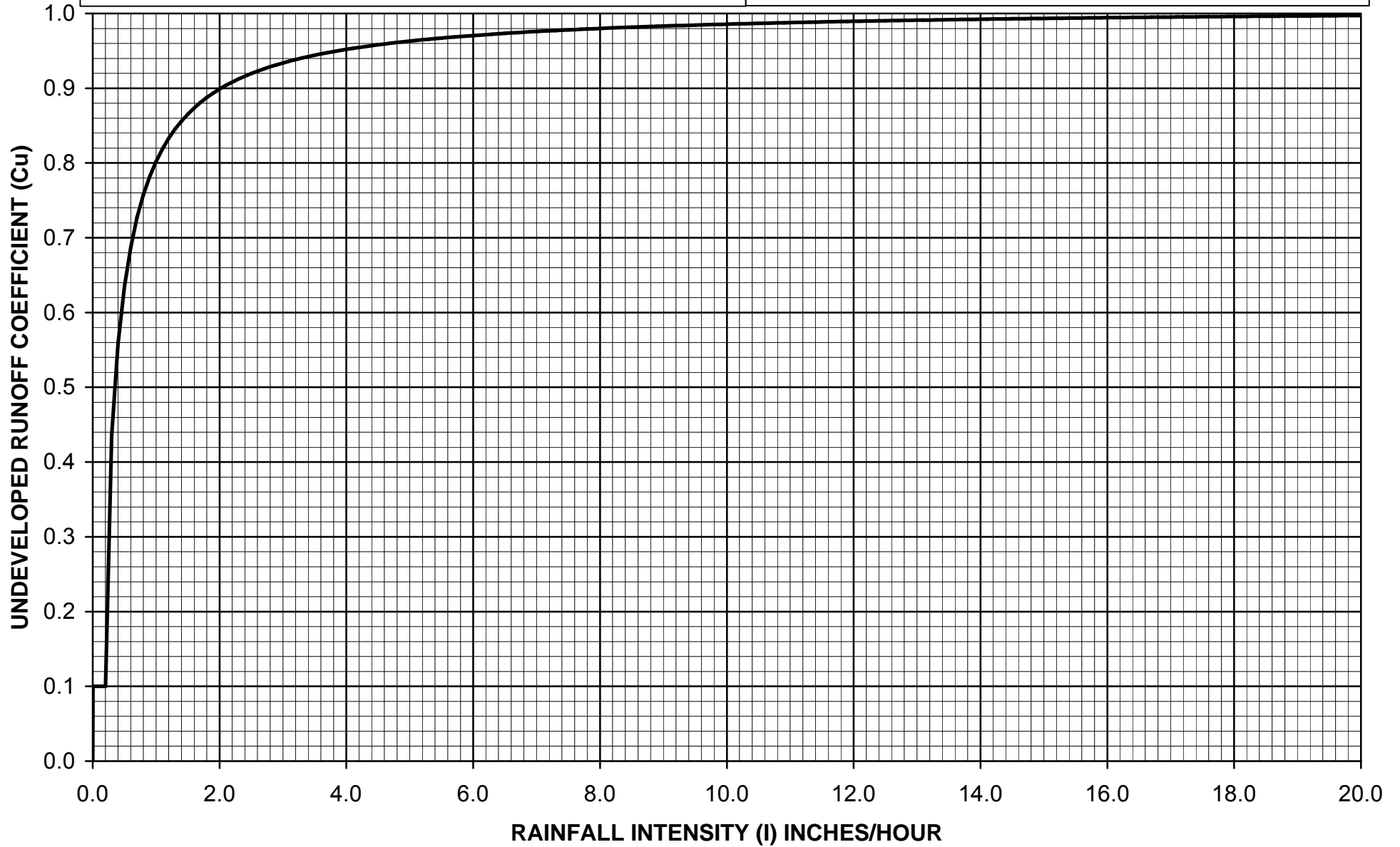

$$C_D = (0.9 * IMP) + (1.0 - IMP) * C_U$$

Where: C_D = Developed Runoff Coefficient
 IMP = Proportion Impervious
 C_U = Undeveloped runoff coefficient



Los Angeles County Department of Public Works

RUNOFF COEFFICIENT CURVE
SOIL TYPE NO. 009

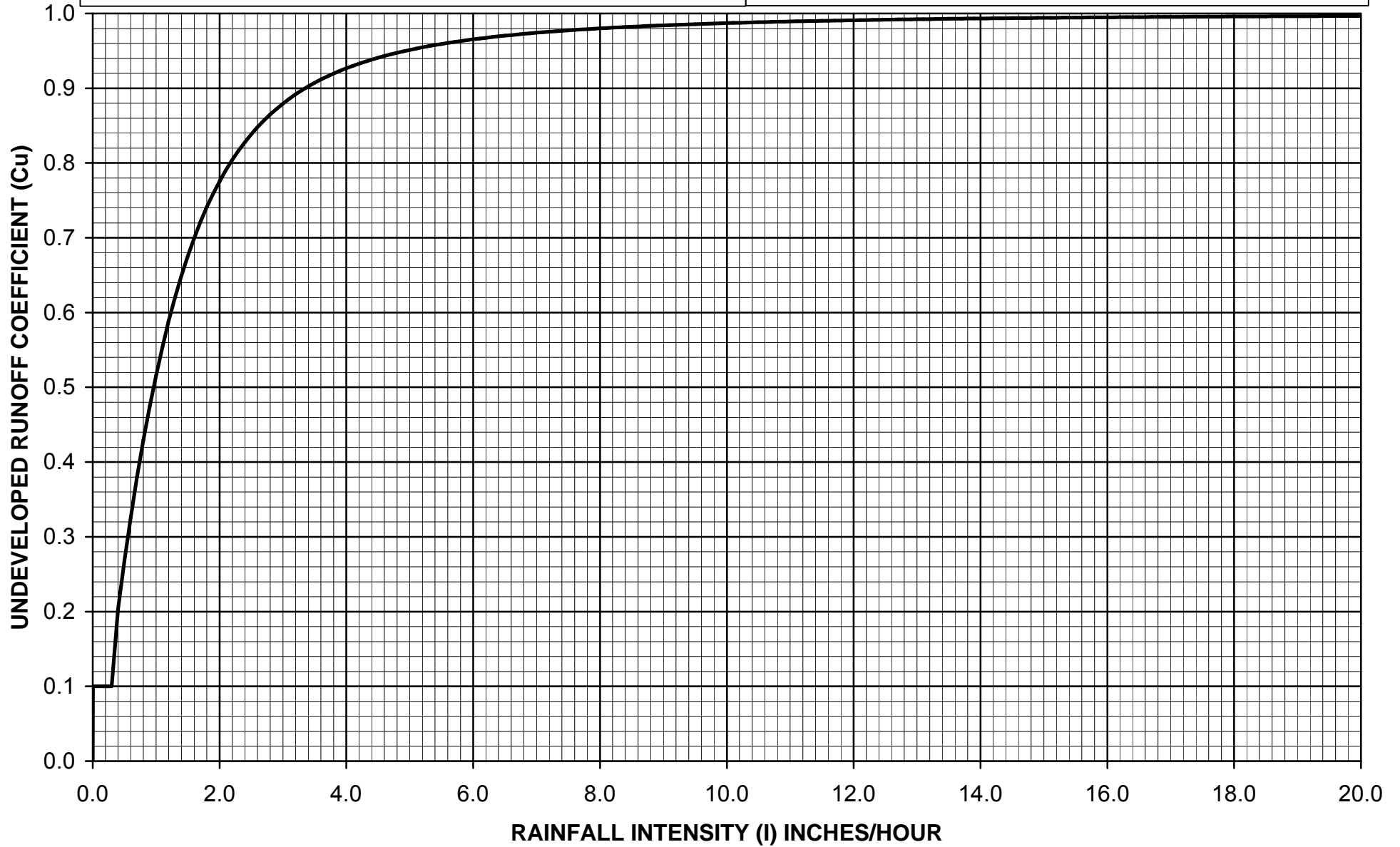

$C_D = (0.9 * IMP) + (1.0 - IMP) * C_U$
 Where: C_D = Developed Runoff Coefficient
 IMP = Proportion Impervious
 C_U = Undeveloped runoff coefficient



Los Angeles County Department of Public Works

**RUNOFF COEFFICIENT CURVE
SOIL TYPE NO. 010**

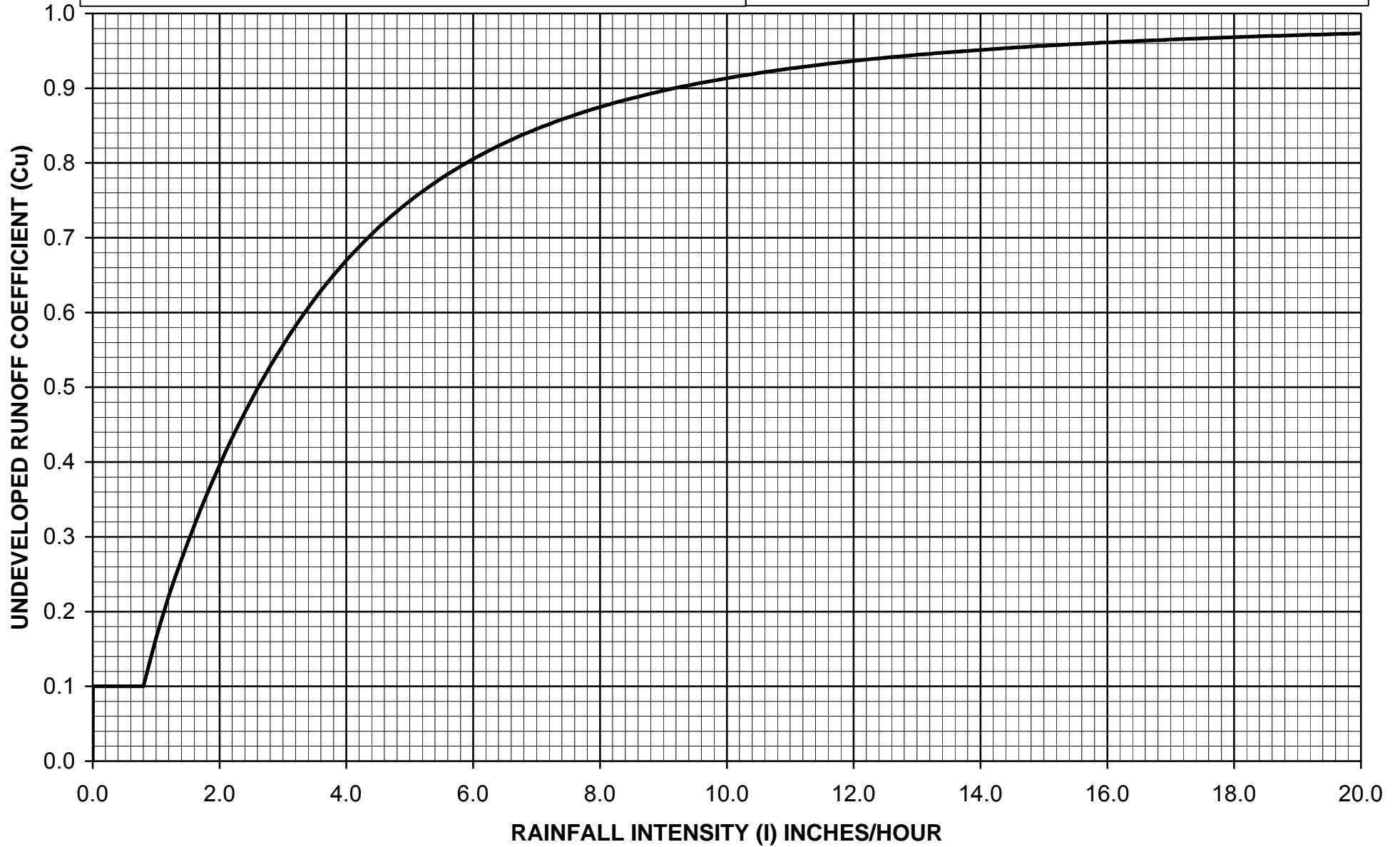

$$C_D = (0.9 * IMP) + (1.0 - IMP) * C_U$$

Where: C_D = Developed Runoff Coefficient

IMP = Proportion Impervious

C_U = Undeveloped runoff coefficient



Los Angeles County Department of Public Works

RUNOFF COEFFICIENT CURVE
SOIL TYPE NO. 011

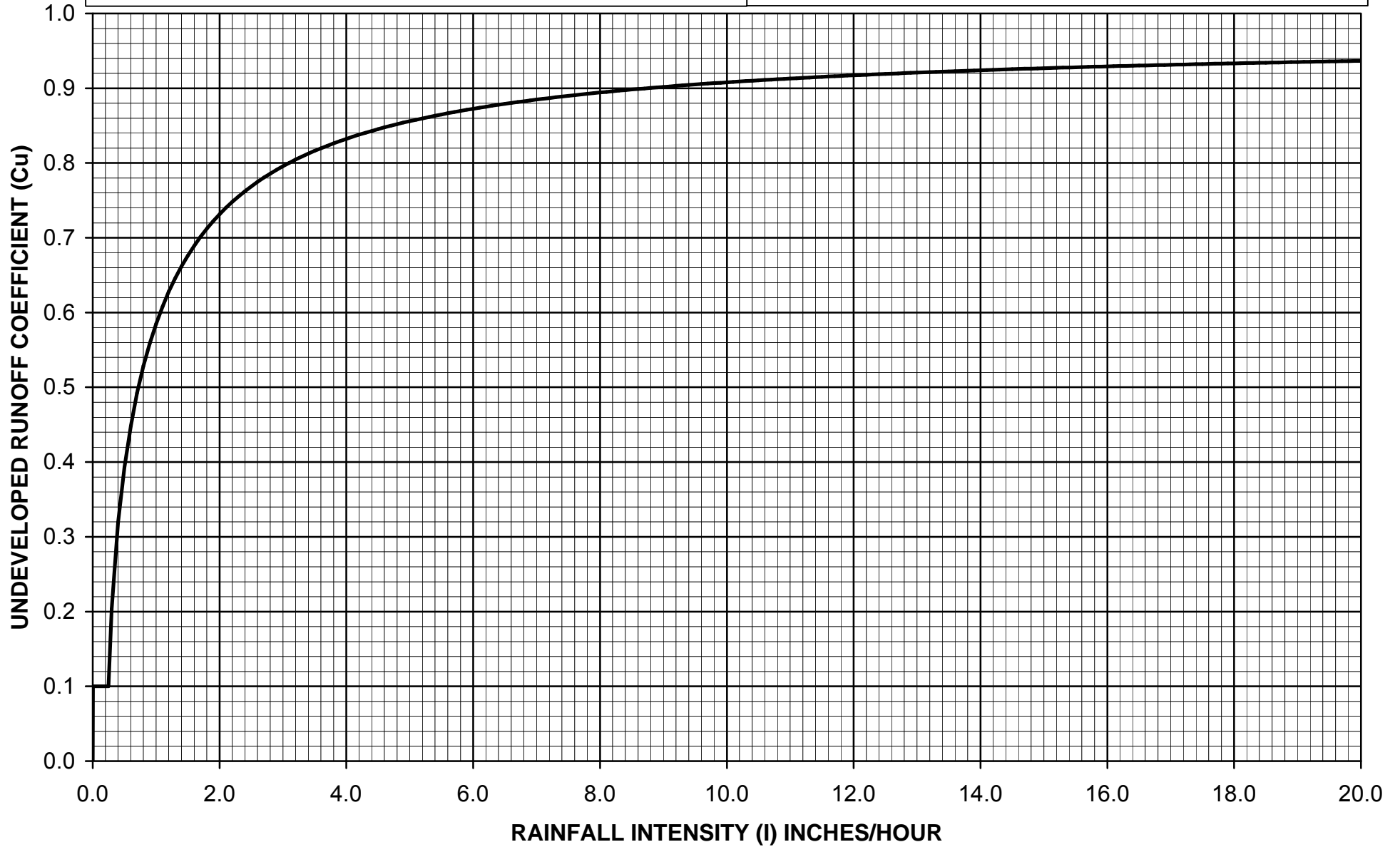

$$C_D = (0.9 * IMP) + (1.0 - IMP) * C_U$$

Where: C_D = Developed Runoff Coefficient
 IMP = Proportion Impervious
 C_U = Undeveloped runoff coefficient



Los Angeles County Department of Public Works

RUNOFF COEFFICIENT CURVE
SOIL TYPE NO. 012

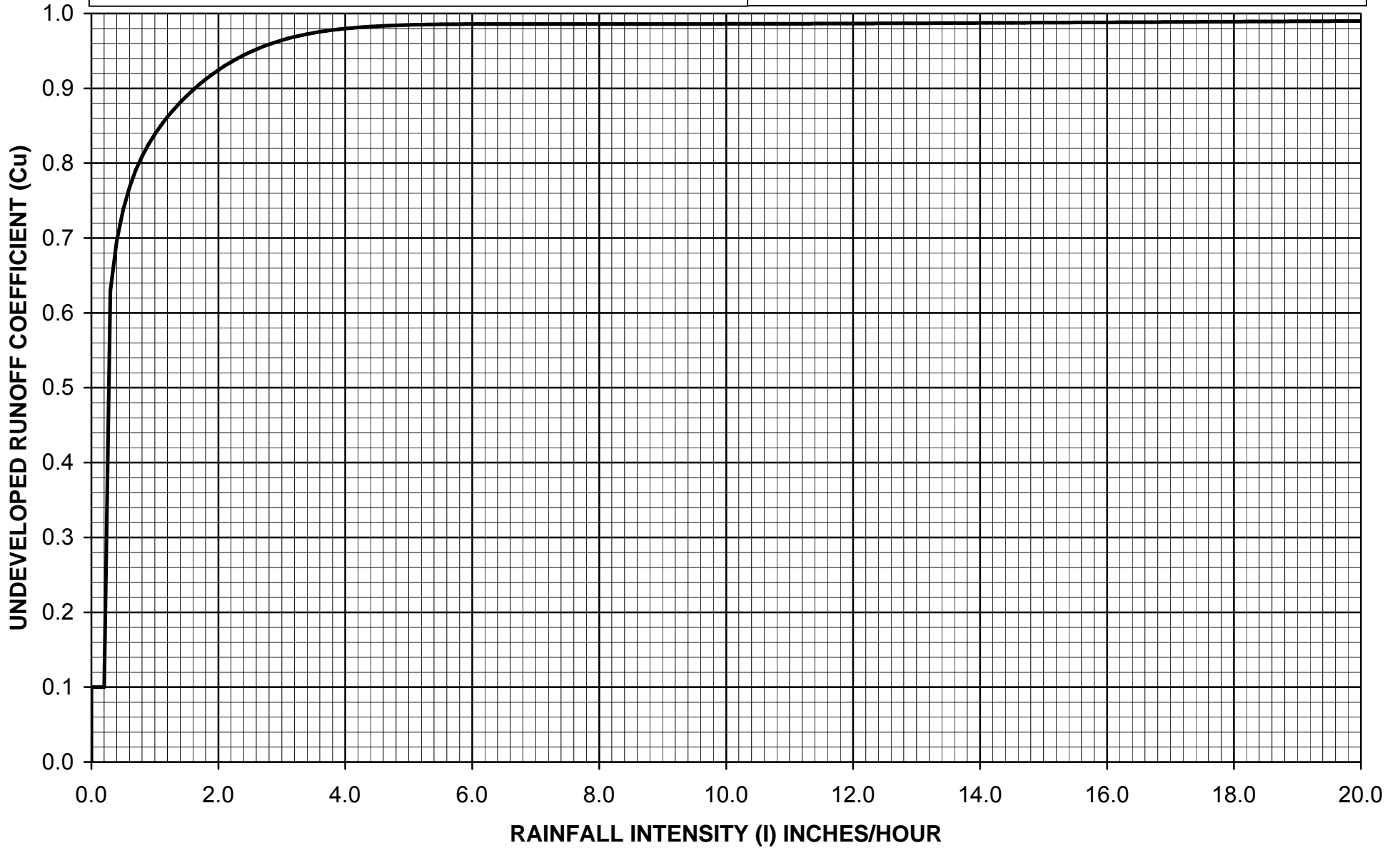

$C_D = (0.9 * IMP) + (1.0 - IMP) * C_U$
 Where: C_D = Developed Runoff Coefficient
 IMP = Proportion Impervious
 C_U = Undeveloped runoff coefficient



Los Angeles County Department of Public Works

RUNOFF COEFFICIENT CURVE
SOIL TYPE NO. 013

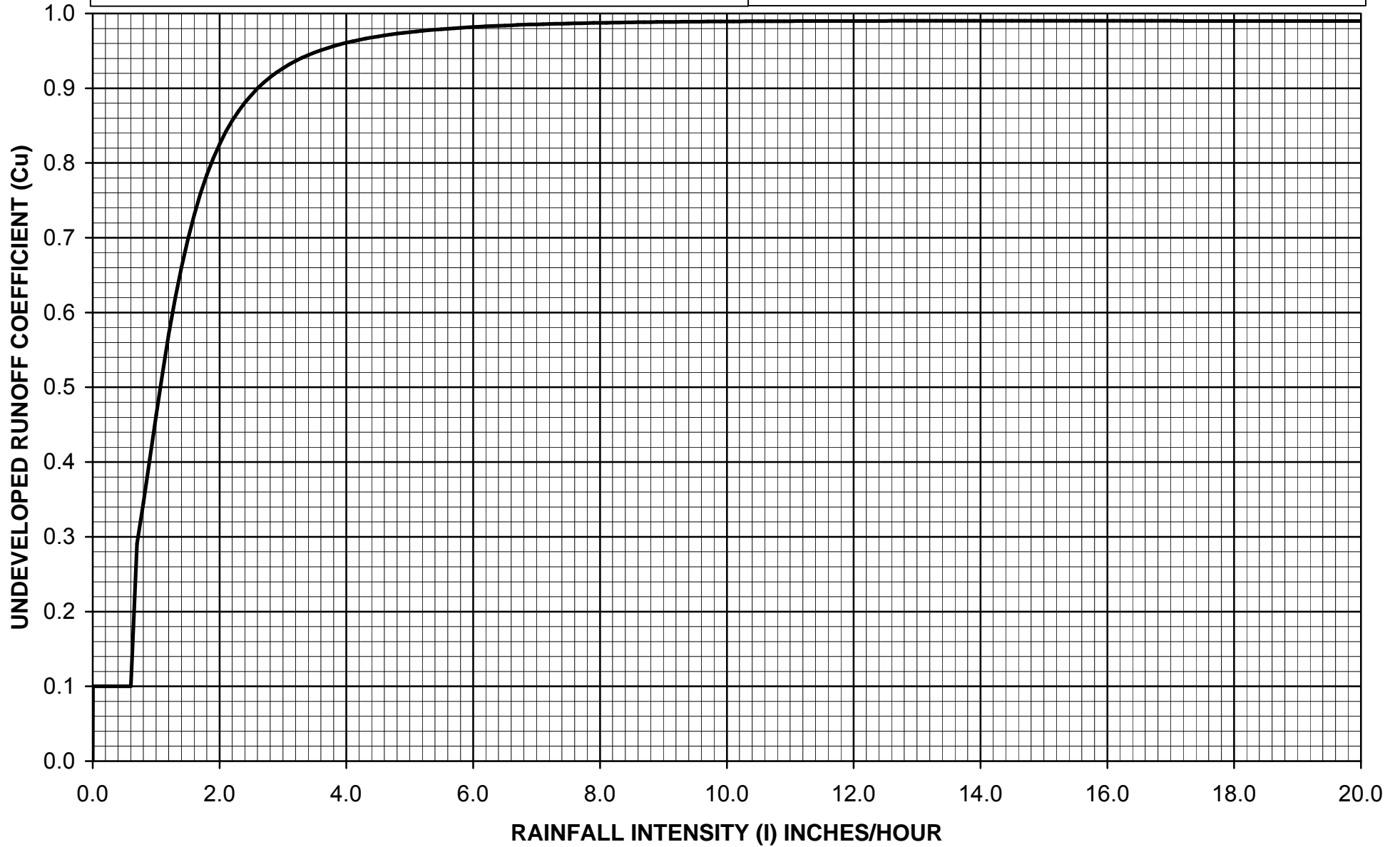

$C_D = (0.9 * IMP) + (1.0 - IMP) * C_U$
 Where: C_D = Developed Runoff Coefficient
 IMP = Proportion Impervious
 C_U = Undeveloped runoff coefficient



Los Angeles County Department of Public Works

**RUNOFF COEFFICIENT CURVE
SOIL TYPE NO. 014**

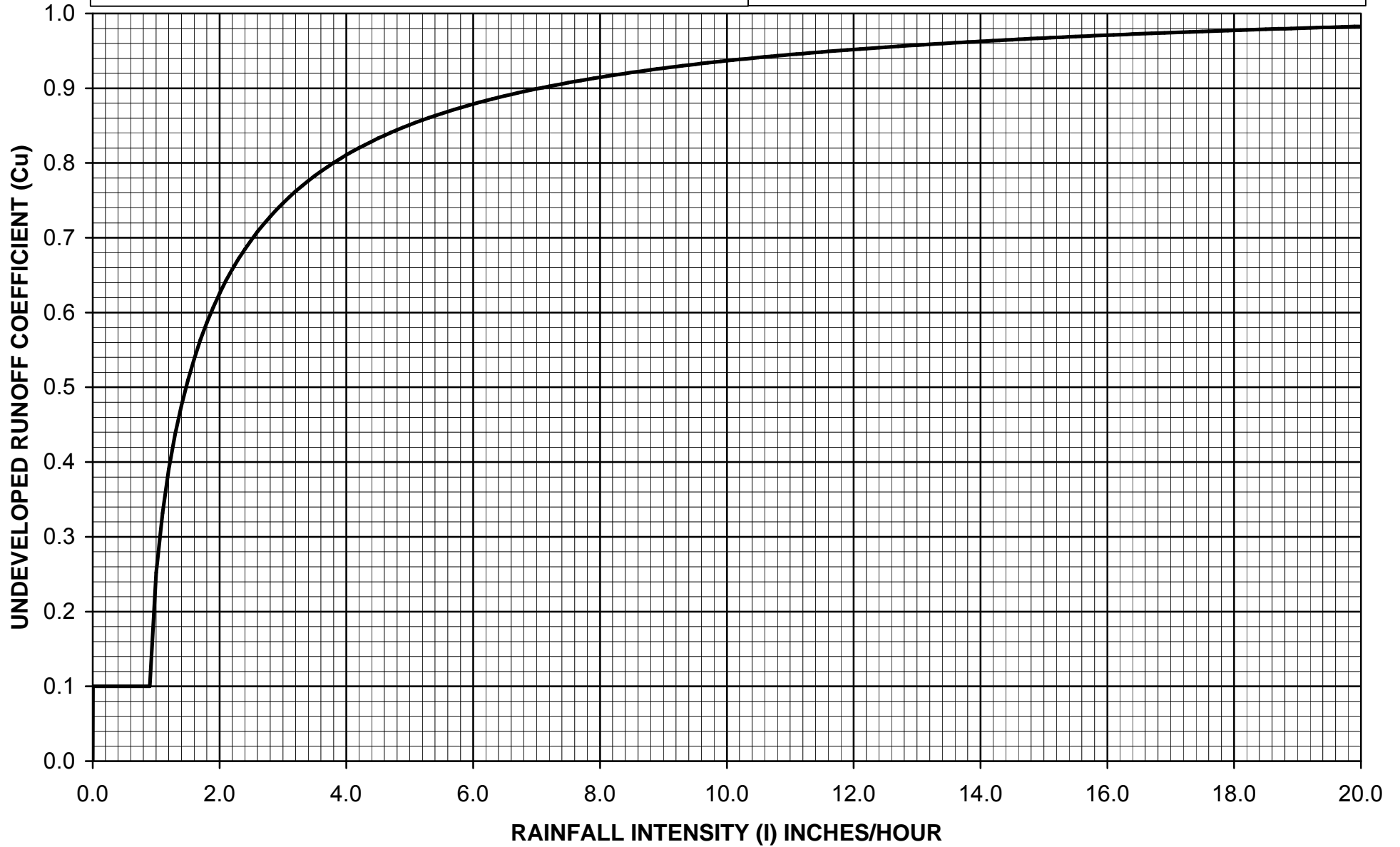

$C_D = (0.9 * IMP) + (1.0 - IMP) * C_U$
 Where: C_D = Developed Runoff Coefficient
 IMP = Proportion Impervious
 C_U = Undeveloped runoff coefficient



Los Angeles County Department of Public Works

RUNOFF COEFFICIENT CURVE
SOIL TYPE NO. 015

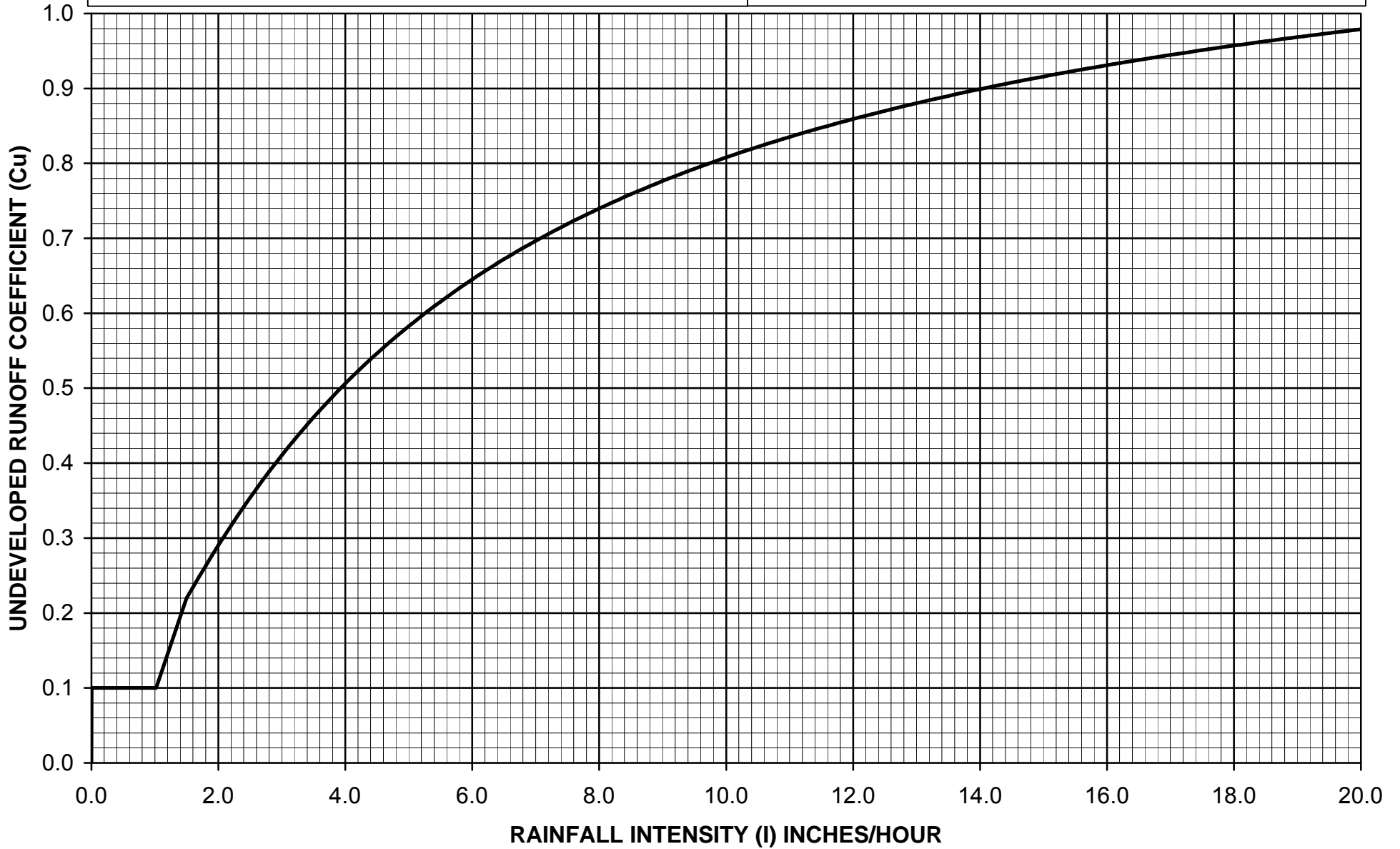

$C_D = (0.9 * IMP) + (1.0 - IMP) * C_U$
 Where: C_D = Developed Runoff Coefficient
 IMP = Proportion Impervious
 C_U = Undeveloped runoff coefficient



Los Angeles County Department of Public Works

RUNOFF COEFFICIENT CURVE
SOIL TYPE NO. 016

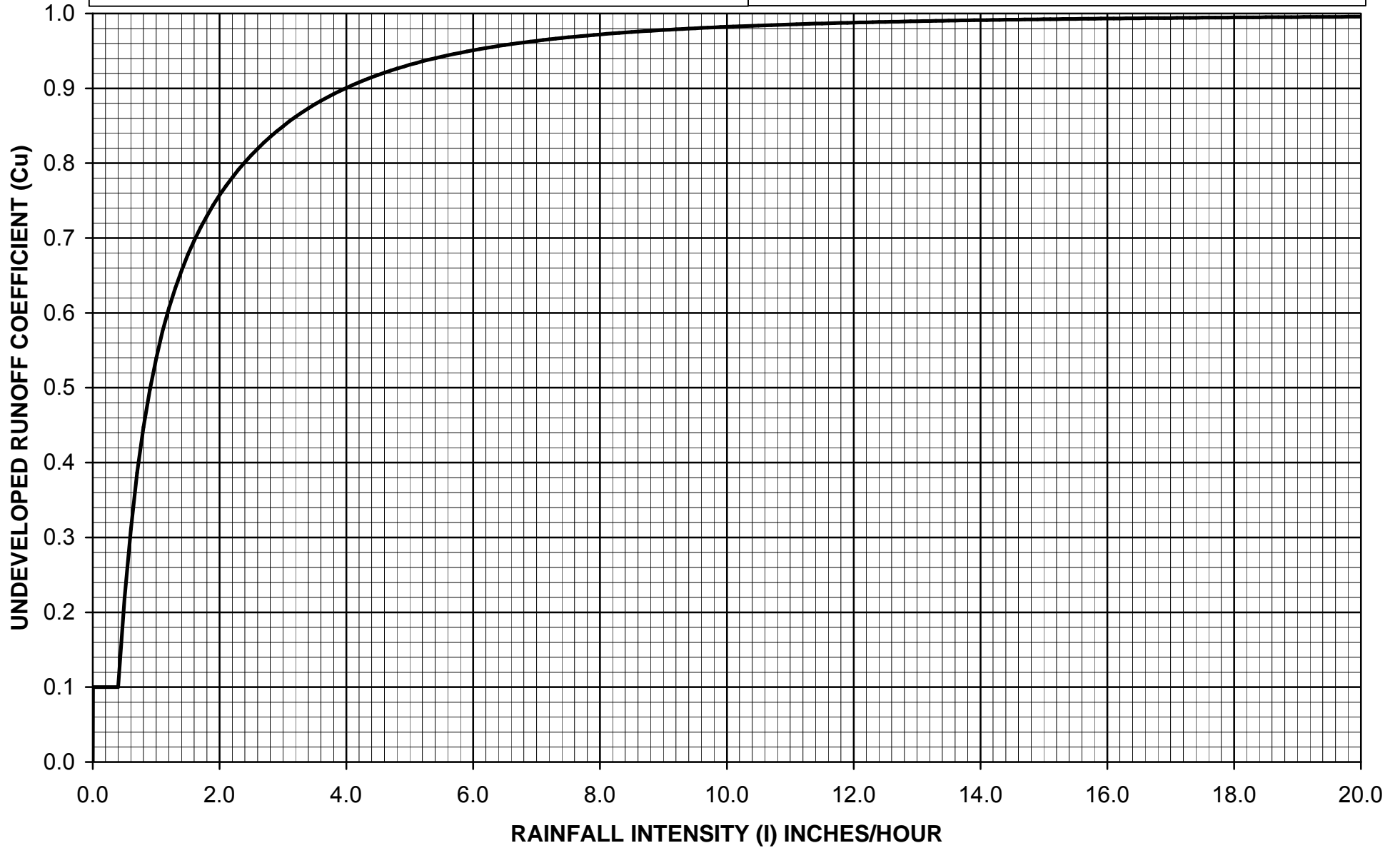

$C_D = (0.9 * IMP) + (1.0 - IMP) * C_U$
 Where: C_D = Developed Runoff Coefficient
 IMP = Proportion Impervious
 C_U = Undeveloped runoff coefficient



Los Angeles County Department of Public Works

RUNOFF COEFFICIENT CURVE
SOIL TYPE NO. 017

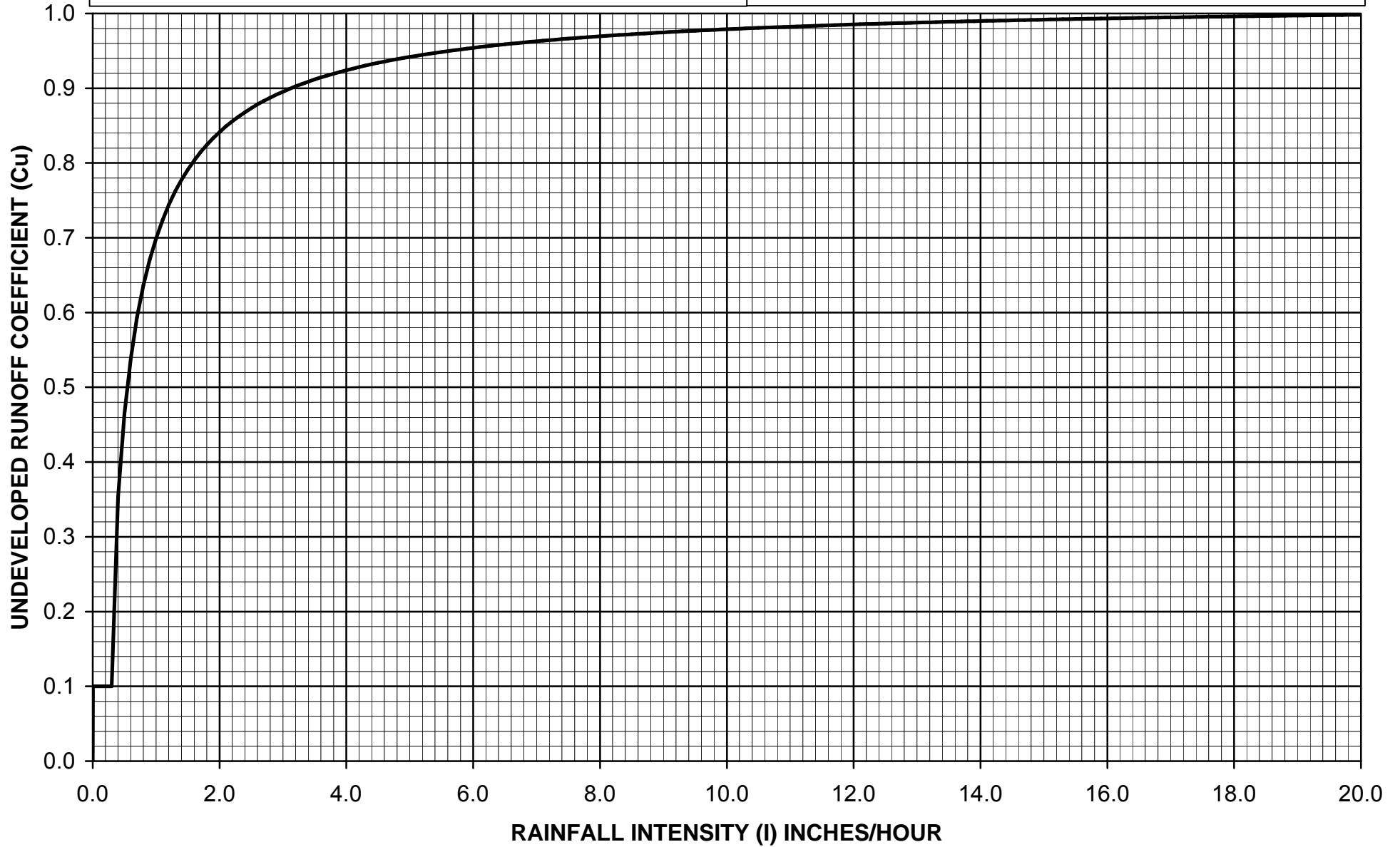

$C_D = (0.9 * IMP) + (1.0 - IMP) * C_U$
 Where: C_D = Developed Runoff Coefficient
 IMP = Proportion Impervious
 C_U = Undeveloped runoff coefficient



Los Angeles County Department of Public Works

RUNOFF COEFFICIENT CURVE
SOIL TYPE NO. 018

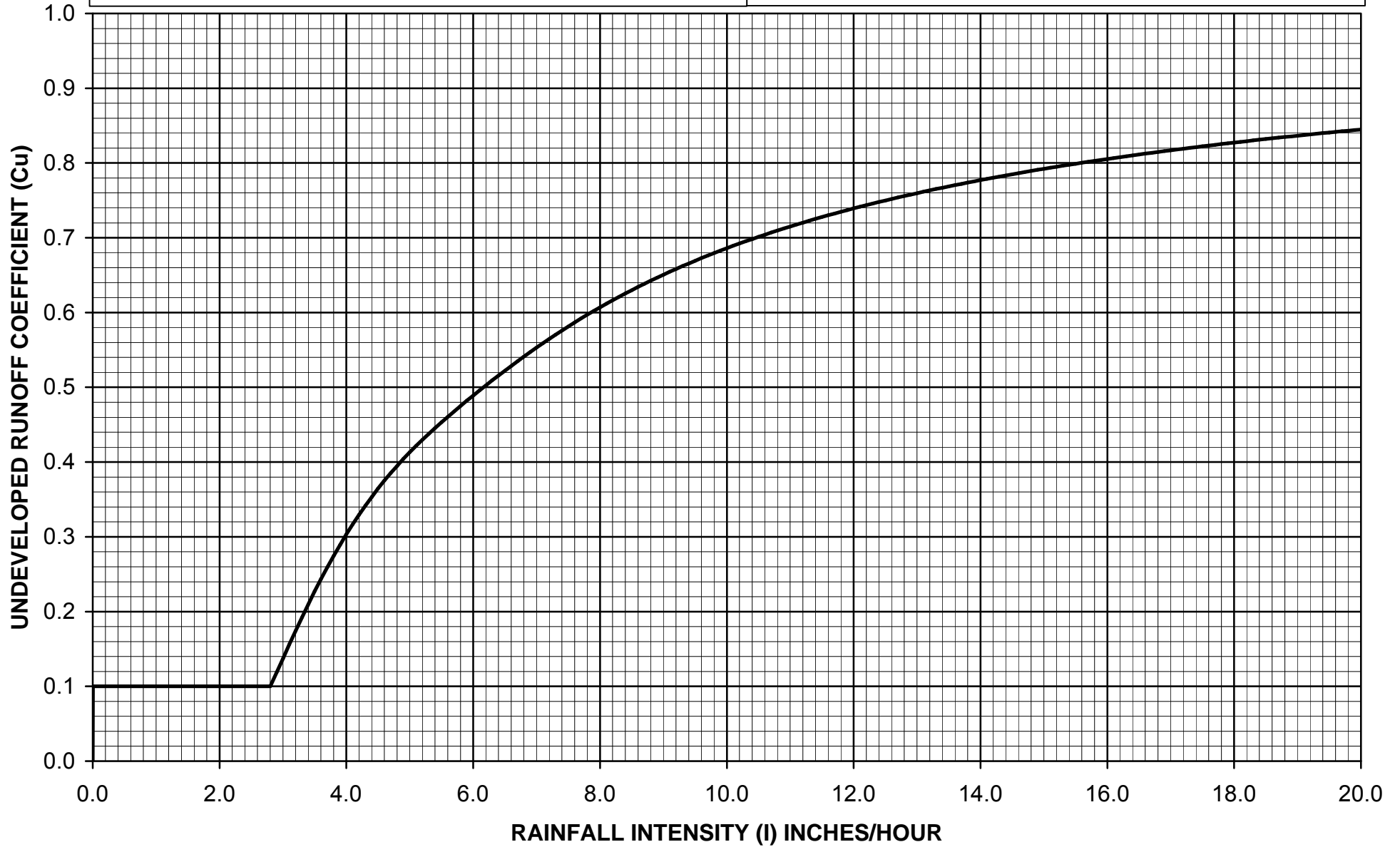

$$C_D = (0.9 * IMP) + (1.0 - IMP) * C_U$$

Where: C_D = Developed Runoff Coefficient

IMP = Proportion Impervious

C_U = Undeveloped runoff coefficient



Los Angeles County Department of Public Works

RUNOFF COEFFICIENT CURVE
SOIL TYPE NO. 019

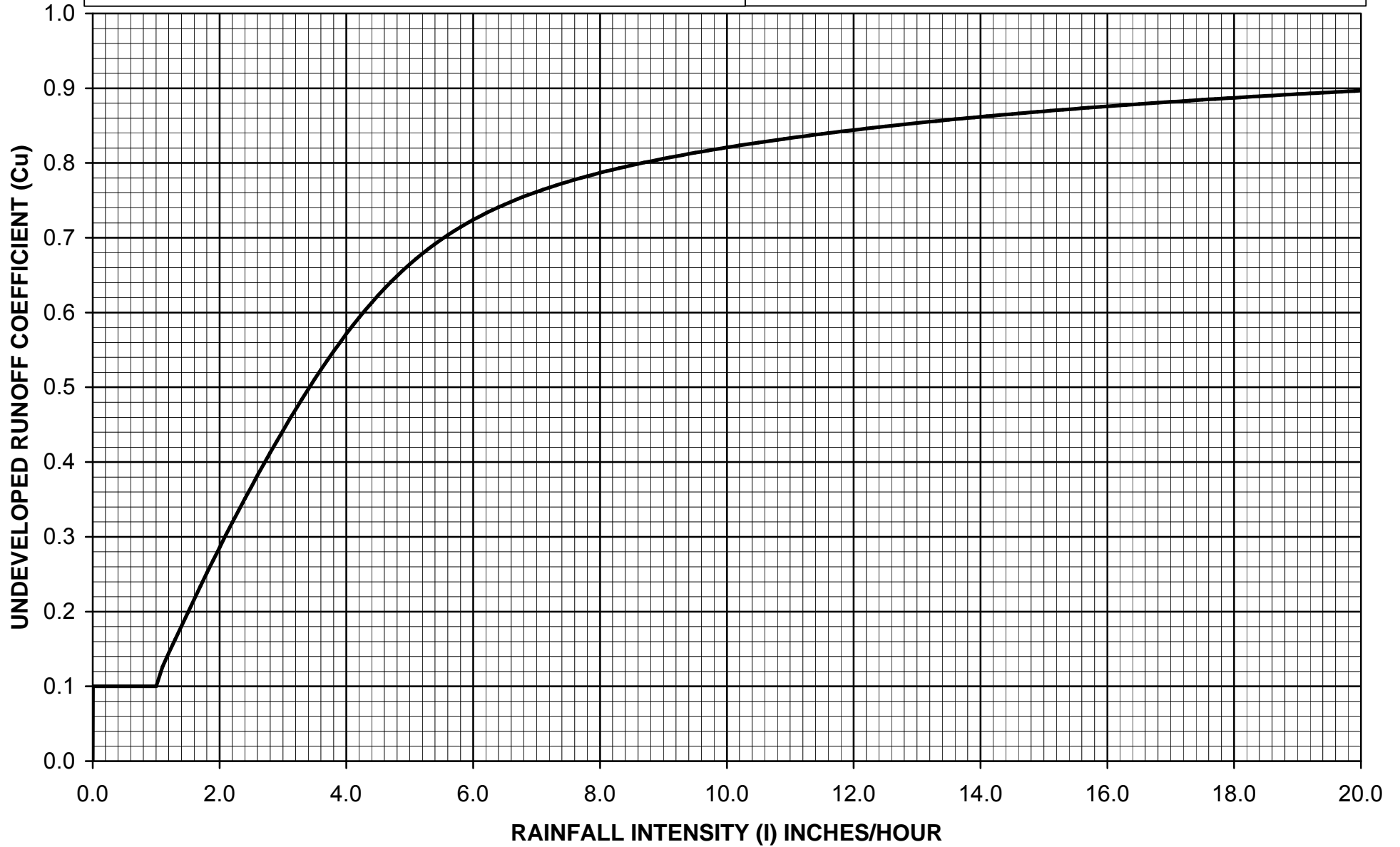

$C_D = (0.9 * IMP) + (1.0 - IMP) * C_U$
 Where: C_D = Developed Runoff Coefficient
 IMP = Proportion Impervious
 C_U = Undeveloped runoff coefficient



Los Angeles County Department of Public Works

RUNOFF COEFFICIENT CURVE
SOIL TYPE NO. 020

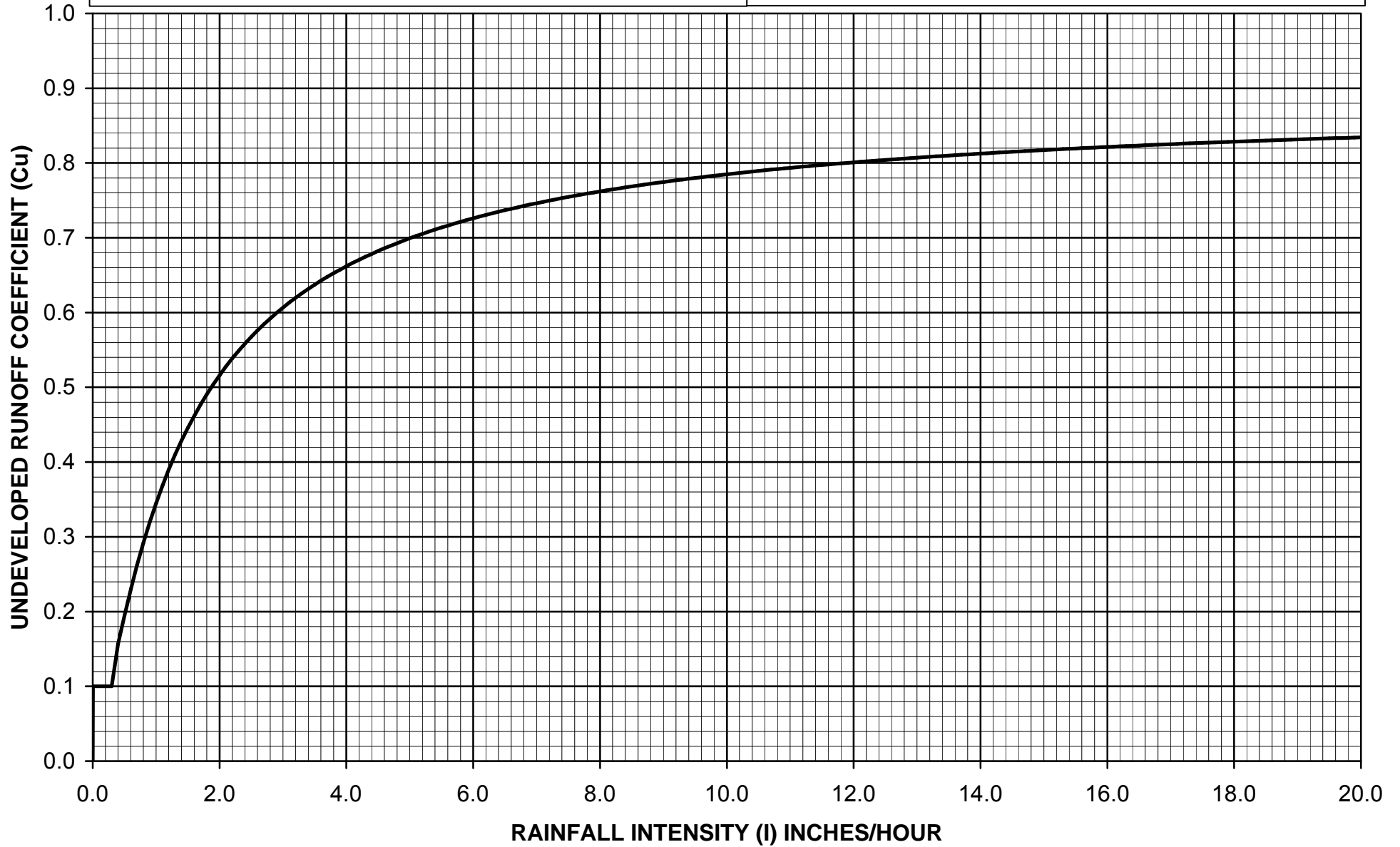

$C_D = (0.9 * IMP) + (1.0 - IMP) * C_U$
 Where: C_D = Developed Runoff Coefficient
 IMP = Proportion Impervious
 C_U = Undeveloped runoff coefficient



Los Angeles County Department of Public Works

RUNOFF COEFFICIENT CURVE
SOIL TYPE NO. 021

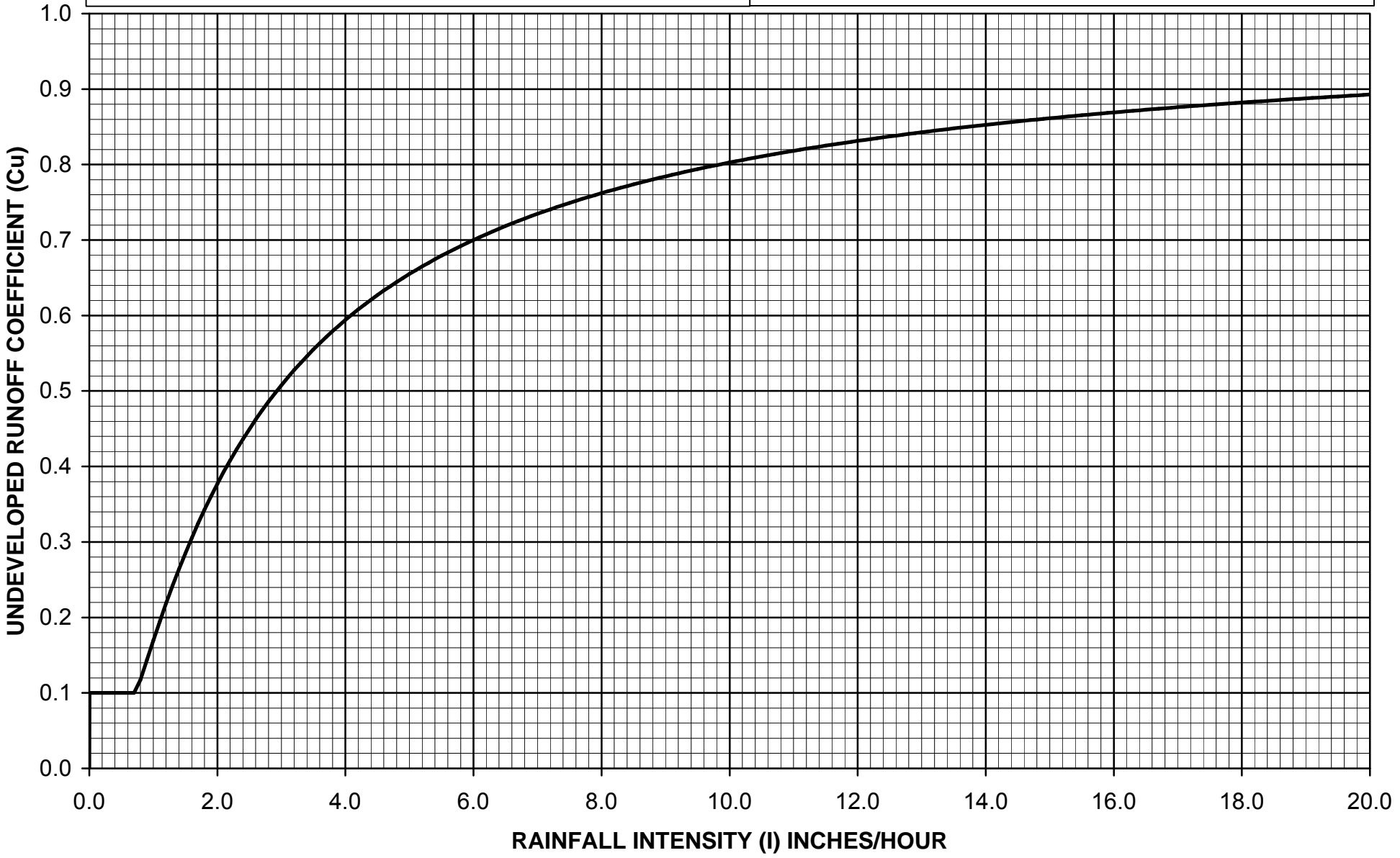

$C_D = (0.9 * IMP) + (1.0 - IMP) * C_U$
 Where: C_D = Developed Runoff Coefficient
 IMP = Proportion Impervious
 C_U = Undeveloped runoff coefficient



Los Angeles County Department of Public Works

**RUNOFF COEFFICIENT CURVE
SOIL TYPE NO. 022**

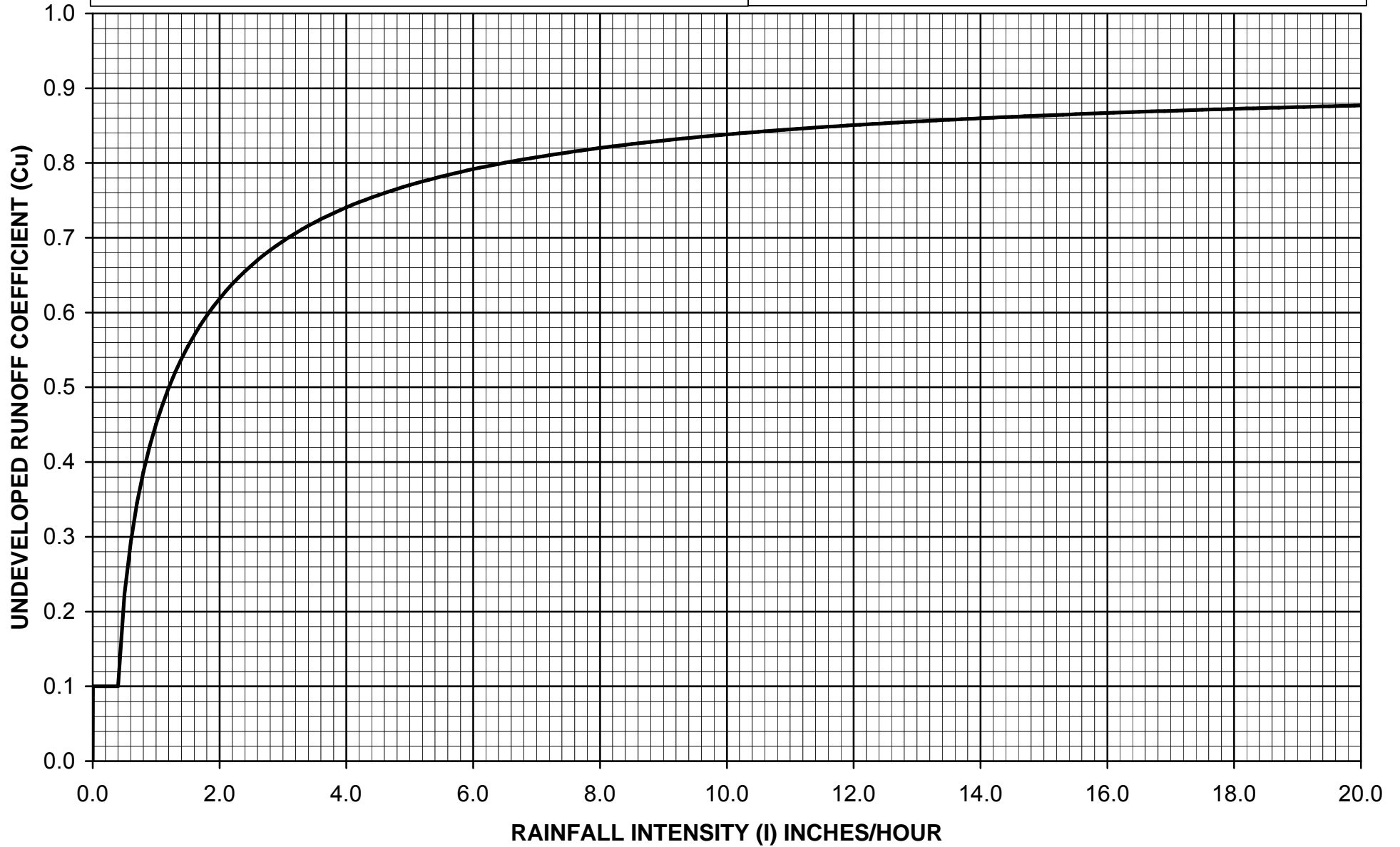

$C_D = (0.9 * IMP) + (1.0 - IMP) * C_U$
Where: C_D = Developed Runoff Coefficient
IMP = Proportion Impervious
 C_U = Undeveloped runoff coefficient



Los Angeles County Department of Public Works

RUNOFF COEFFICIENT CURVE
SOIL TYPE NO. 023

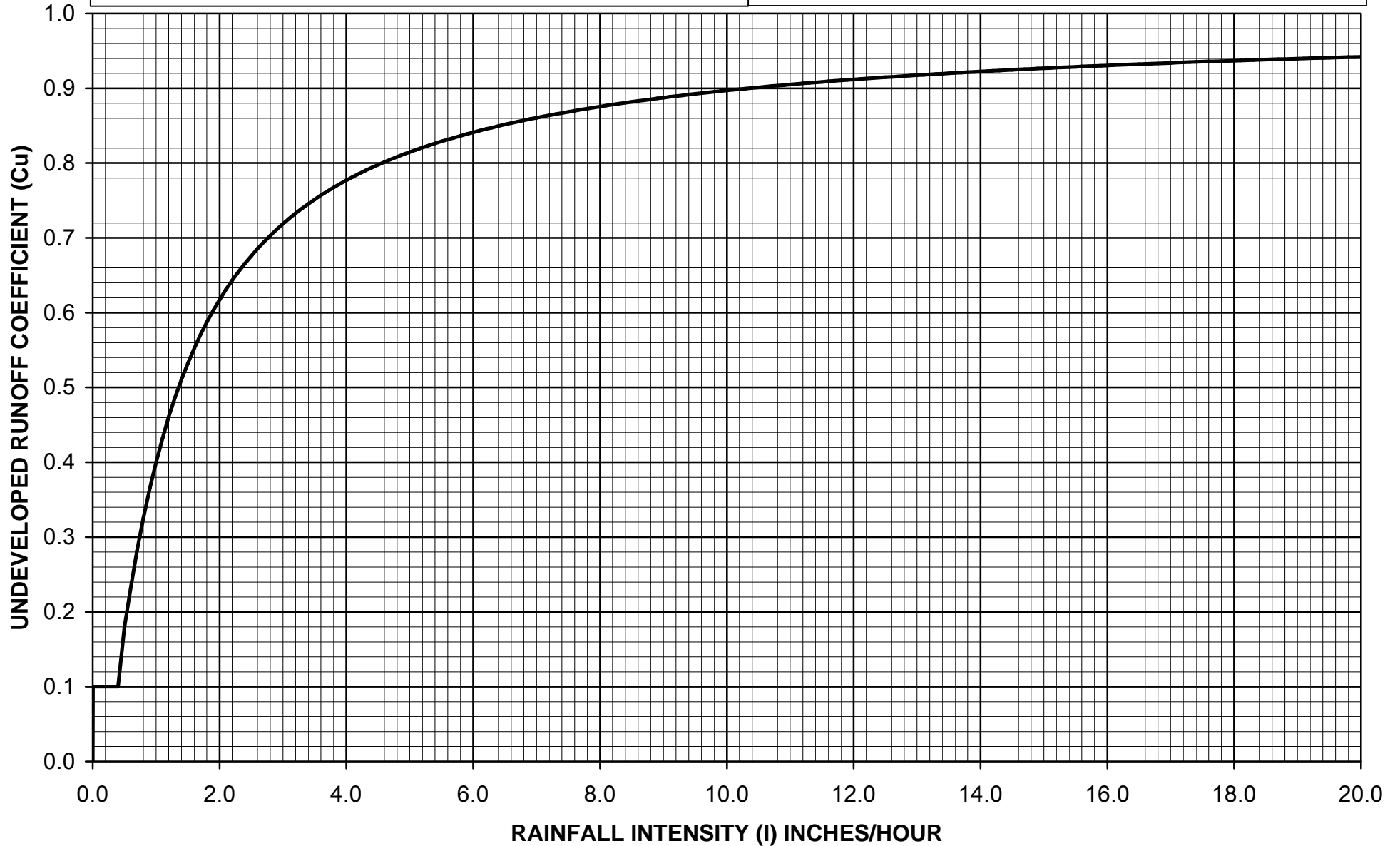

$C_D = (0.9 * IMP) + (1.0 - IMP) * C_U$
 Where: C_D = Developed Runoff Coefficient
 IMP = Proportion Impervious
 C_U = Undeveloped runoff coefficient



Los Angeles County Department of Public Works

RUNOFF COEFFICIENT CURVE
SOIL TYPE NO. 024

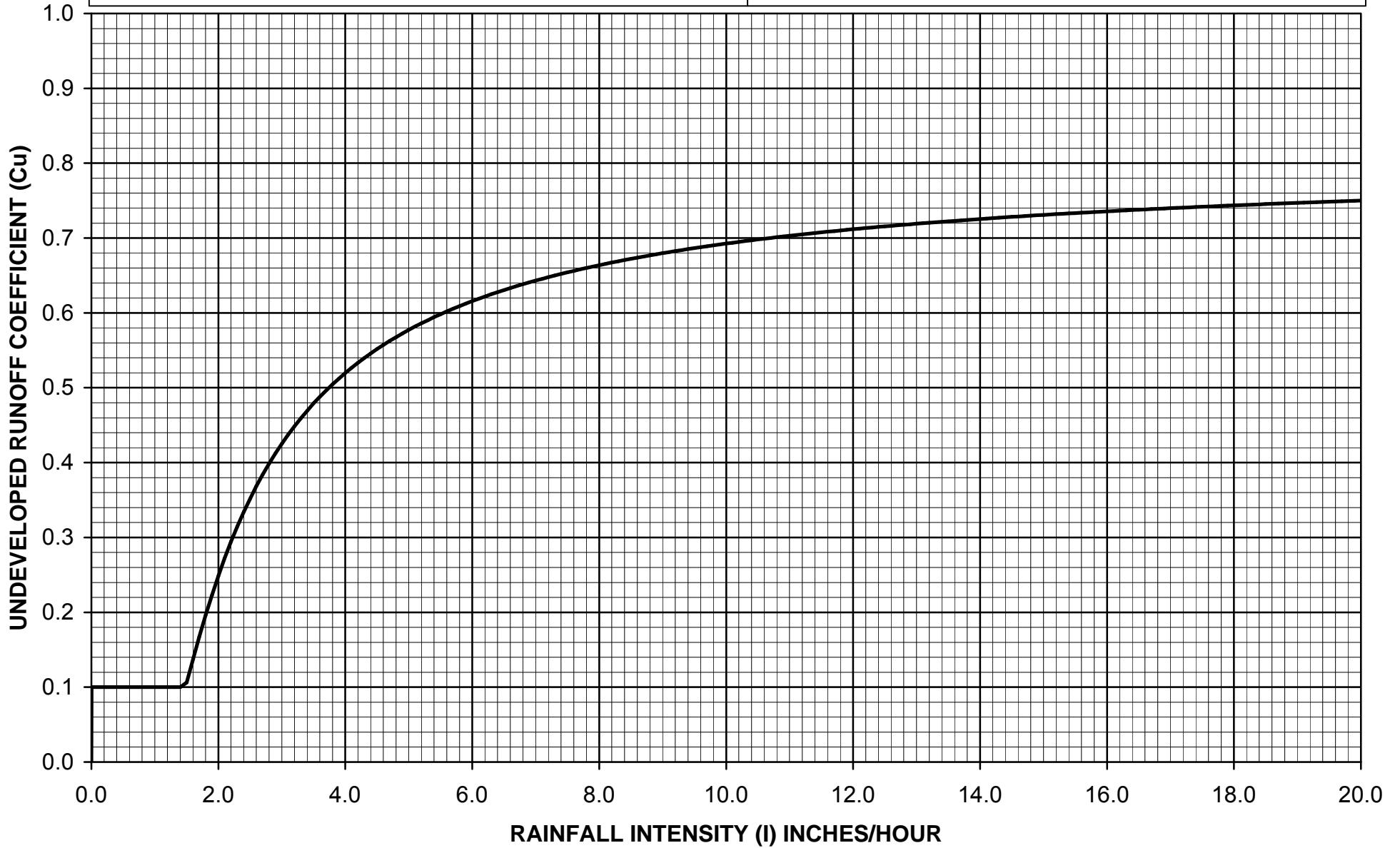

$C_D = (0.9 * IMP) + (1.0 - IMP) * C_U$
 Where: C_D = Developed Runoff Coefficient
 IMP = Proportion Impervious
 C_U = Undeveloped runoff coefficient



Los Angeles County Department of Public Works

RUNOFF COEFFICIENT CURVE
SOIL TYPE NO. 025

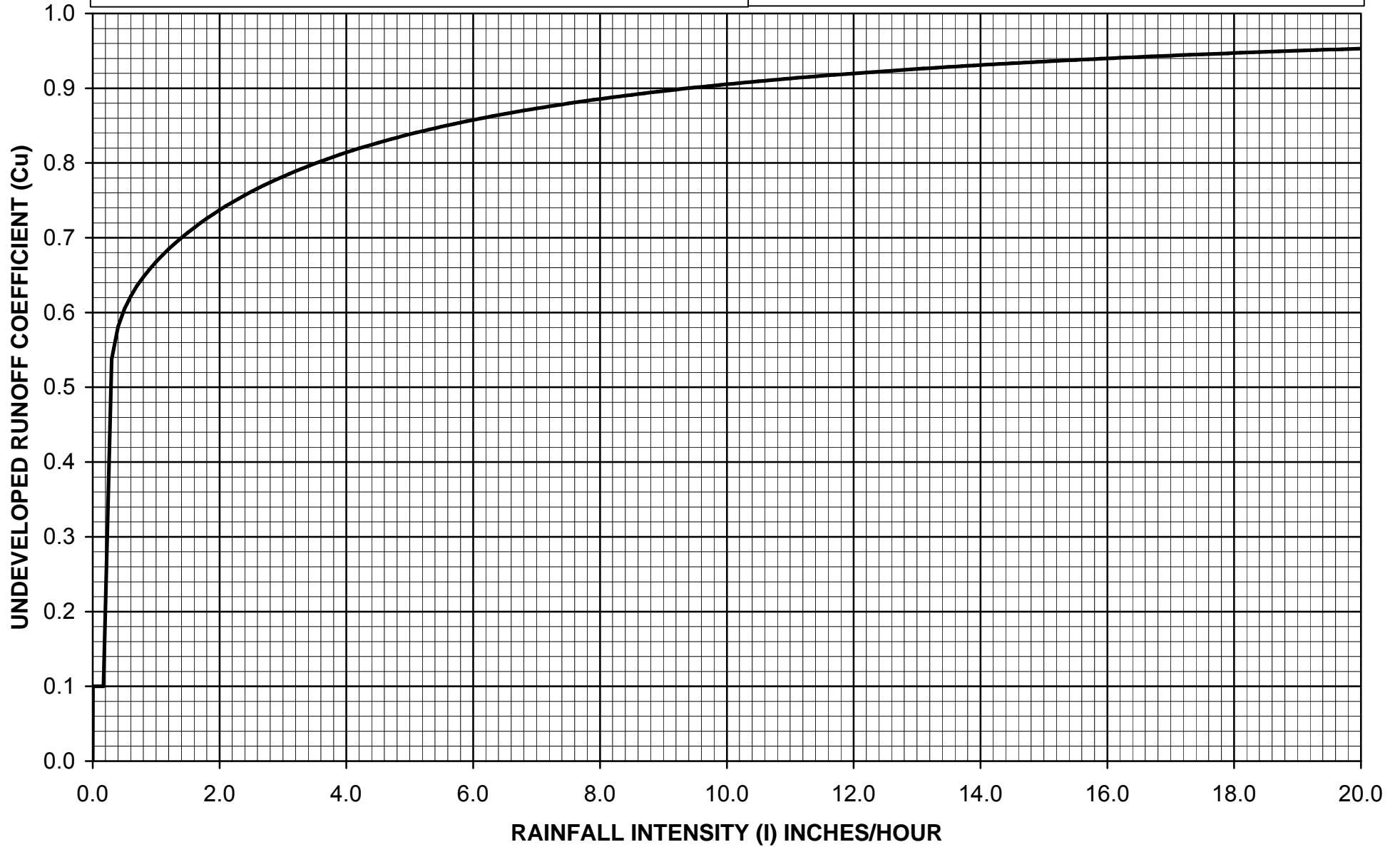

$C_D = (0.9 * IMP) + (1.0 - IMP) * C_U$
 Where: C_D = Developed Runoff Coefficient
 IMP = Proportion Impervious
 C_U = Undeveloped runoff coefficient



Los Angeles County Department of Public Works

RUNOFF COEFFICIENT CURVE
SOIL TYPE NO. 026

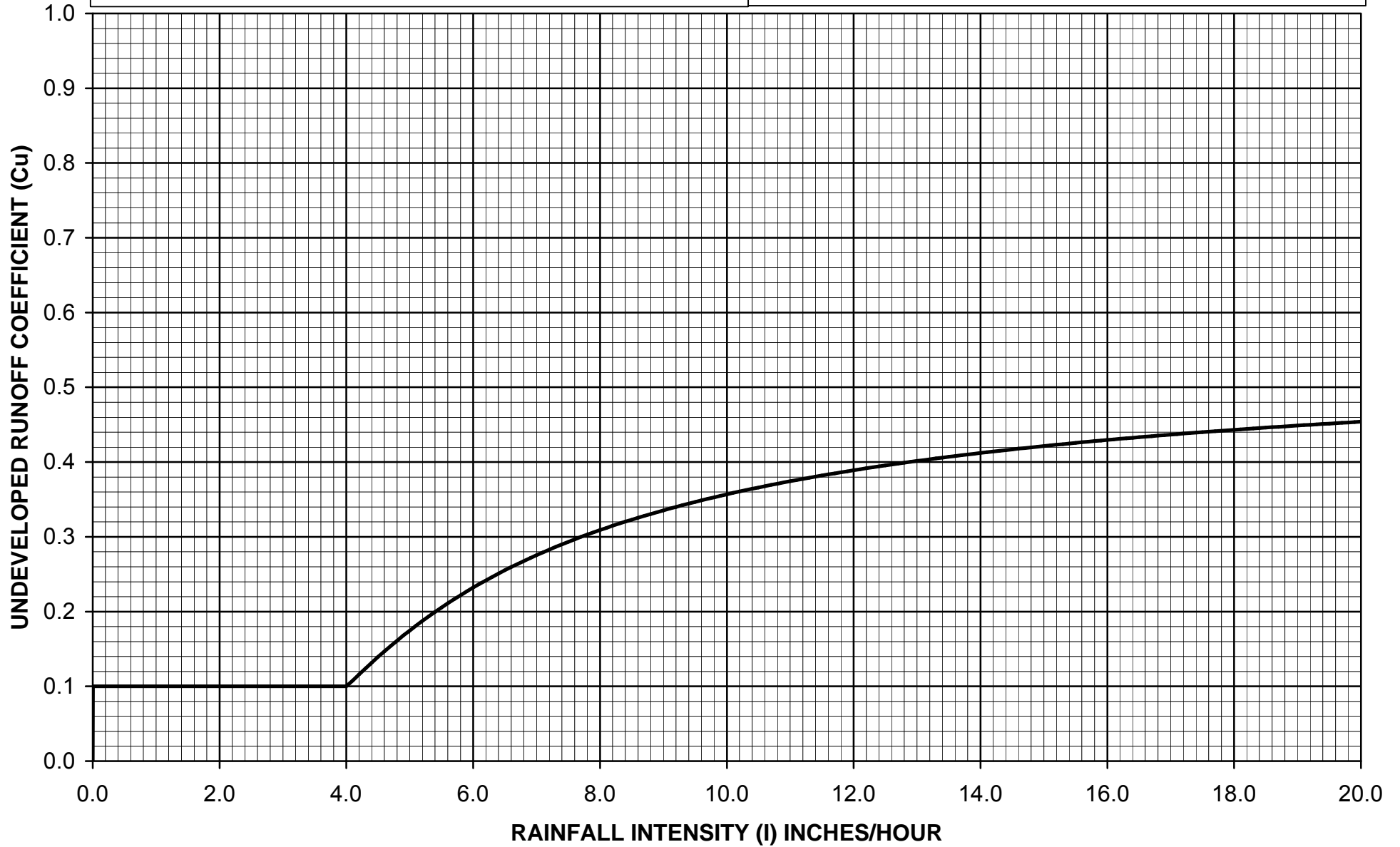

$C_D = (0.9 * IMP) + (1.0 - IMP) * C_U$
 Where: C_D = Developed Runoff Coefficient
 IMP = Proportion Impervious
 C_U = Undeveloped runoff coefficient



Los Angeles County Department of Public Works

RUNOFF COEFFICIENT CURVE
SOIL TYPE NO. 027

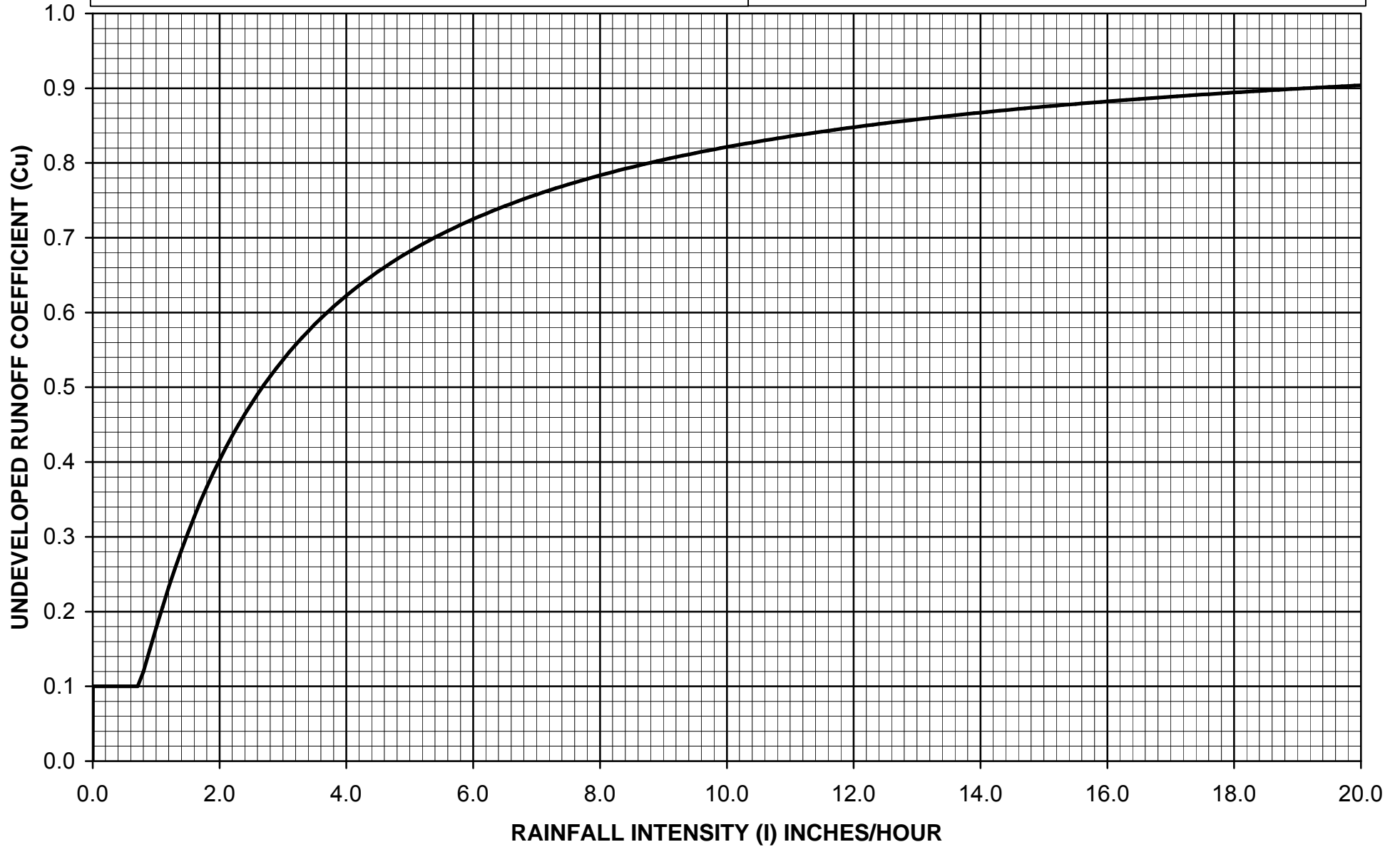

$C_D = (0.9 * IMP) + (1.0 - IMP) * C_U$
 Where: C_D = Developed Runoff Coefficient
 IMP = Proportion Impervious
 C_U = Undeveloped runoff coefficient



Los Angeles County Department of Public Works

RUNOFF COEFFICIENT CURVE
SOIL TYPE NO. 028

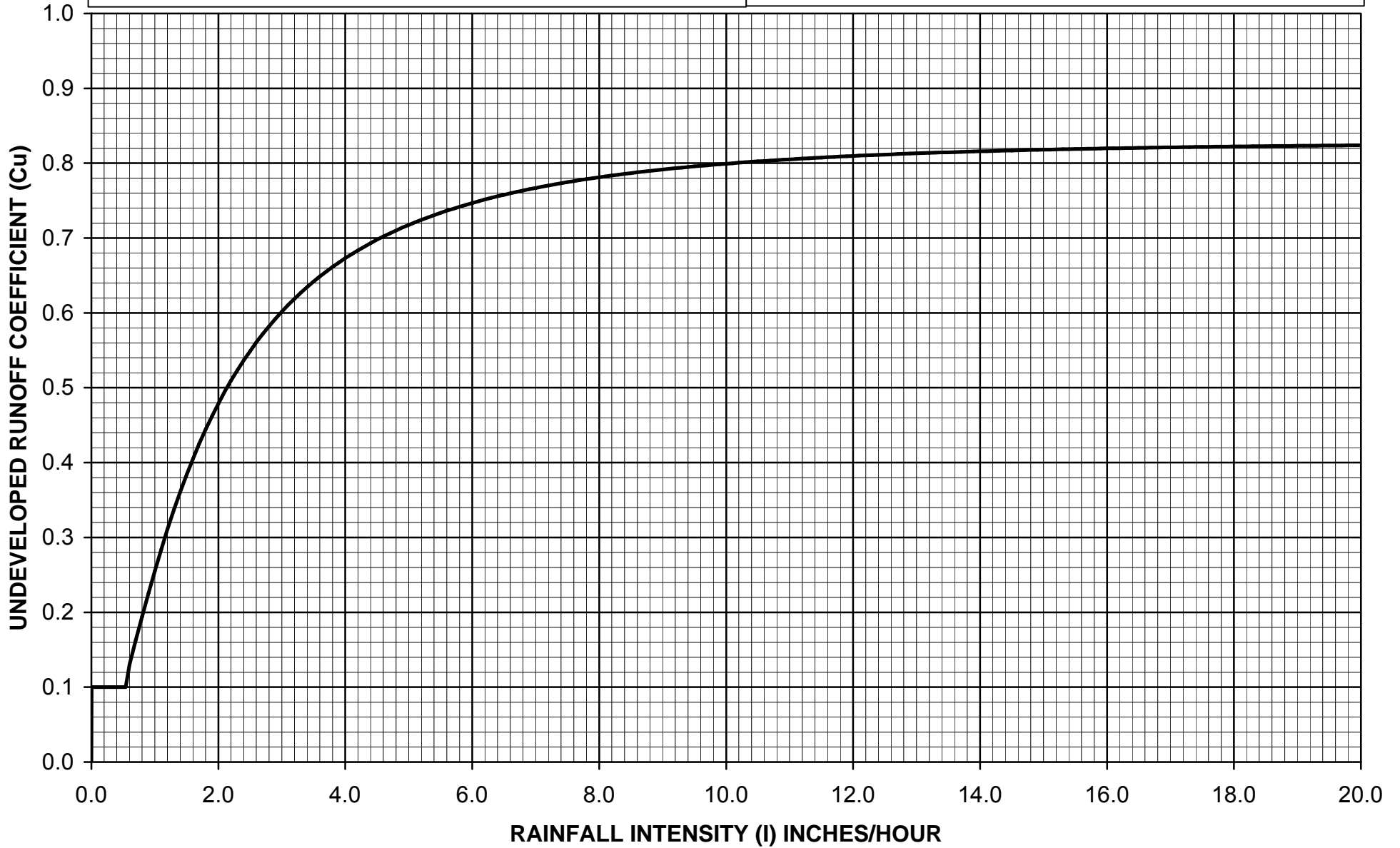

$C_D = (0.9 * IMP) + (1.0 - IMP) * C_U$
 Where: C_D = Developed Runoff Coefficient
 IMP = Proportion Impervious
 C_U = Undeveloped runoff coefficient



Los Angeles County Department of Public Works

RUNOFF COEFFICIENT CURVE
SOIL TYPE NO. 029

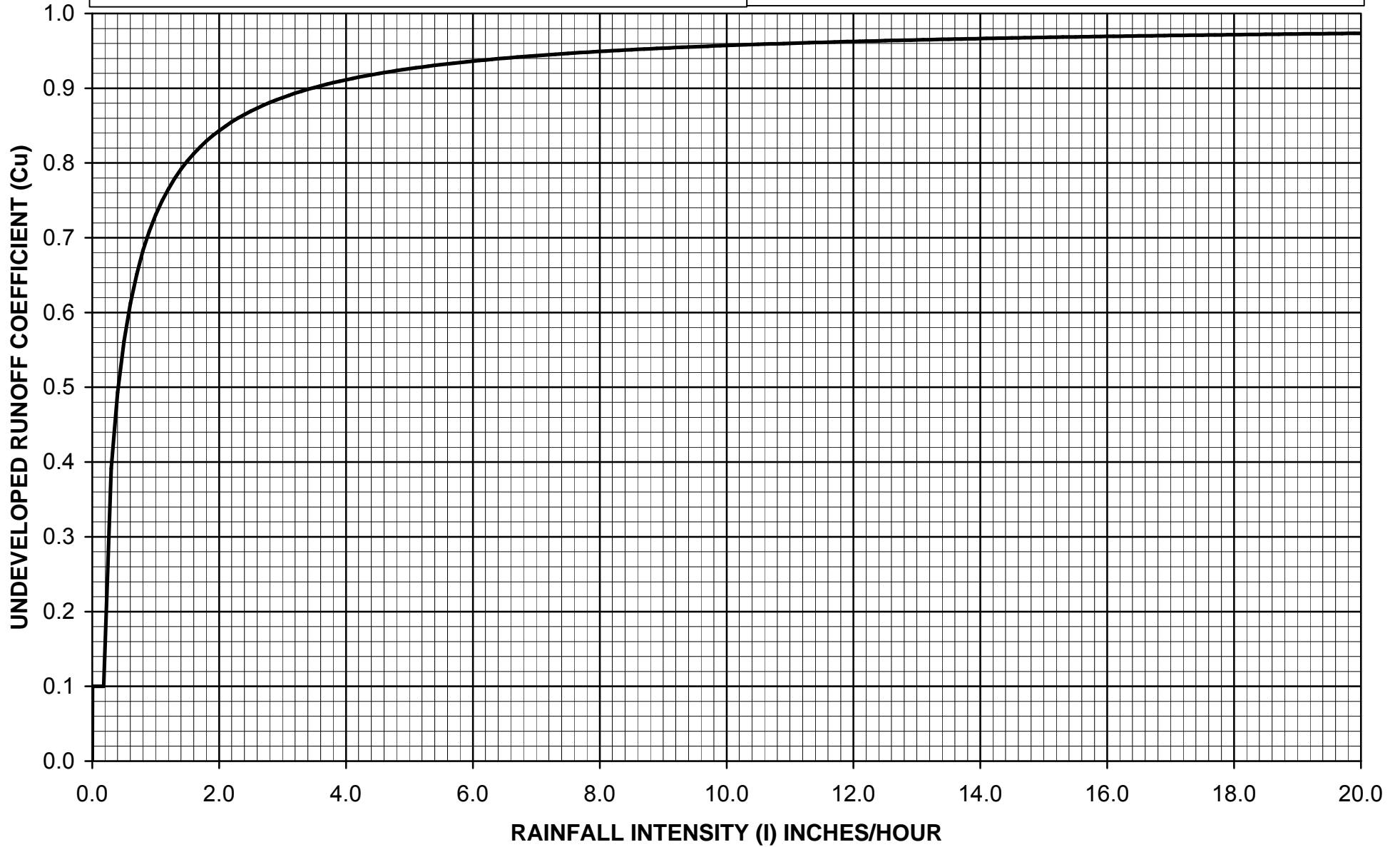

$C_D = (0.9 * IMP) + (1.0 - IMP) * C_U$
 Where: C_D = Developed Runoff Coefficient
 IMP = Proportion Impervious
 C_U = Undeveloped runoff coefficient



Los Angeles County Department of Public Works

RUNOFF COEFFICIENT CURVE
SOIL TYPE NO. 030

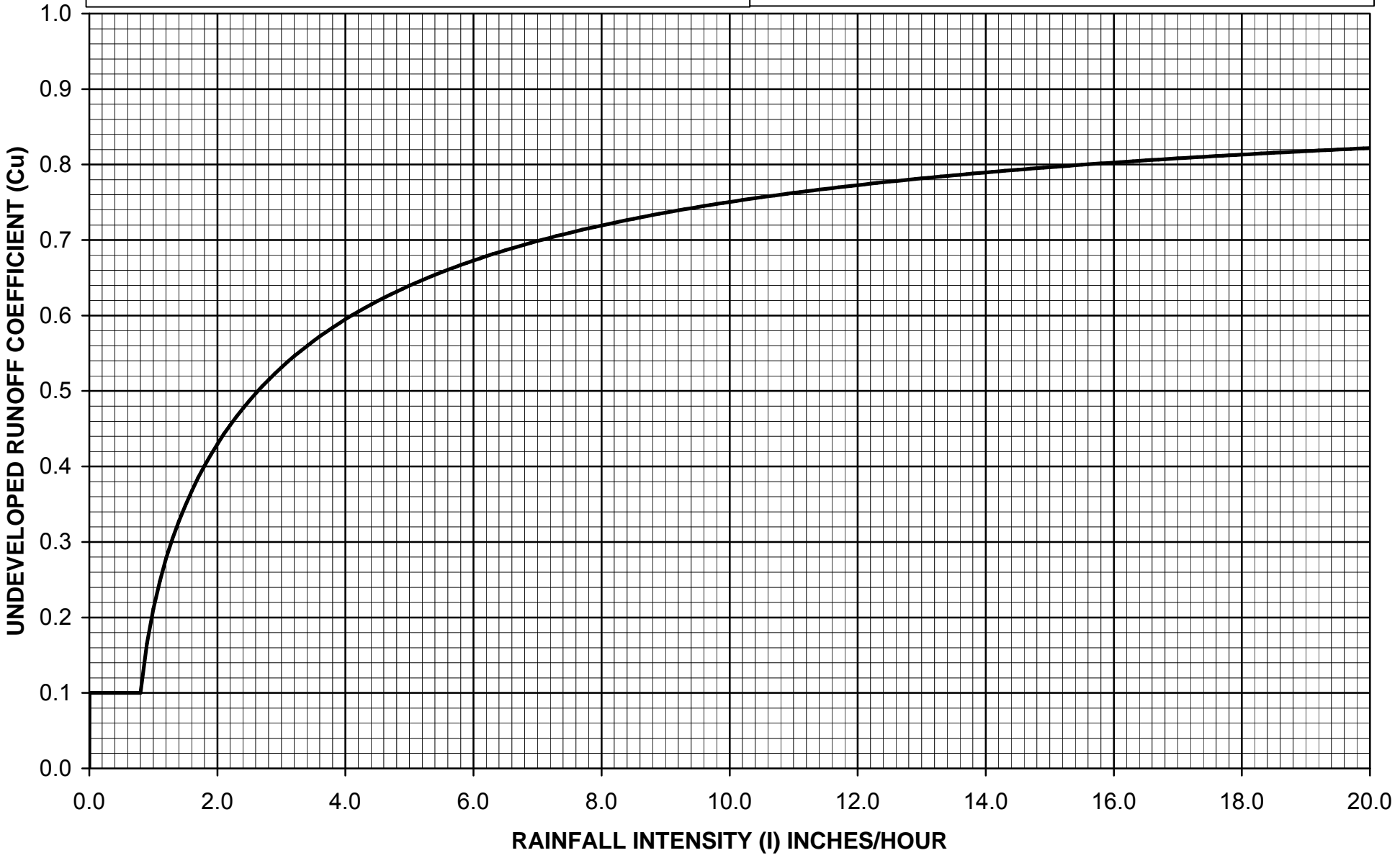

$C_D = (0.9 * IMP) + (1.0 - IMP) * C_U$
 Where: C_D = Developed Runoff Coefficient
 IMP = Proportion Impervious
 C_U = Undeveloped runoff coefficient



Los Angeles County Department of Public Works

RUNOFF COEFFICIENT CURVE
SOIL TYPE NO. 031

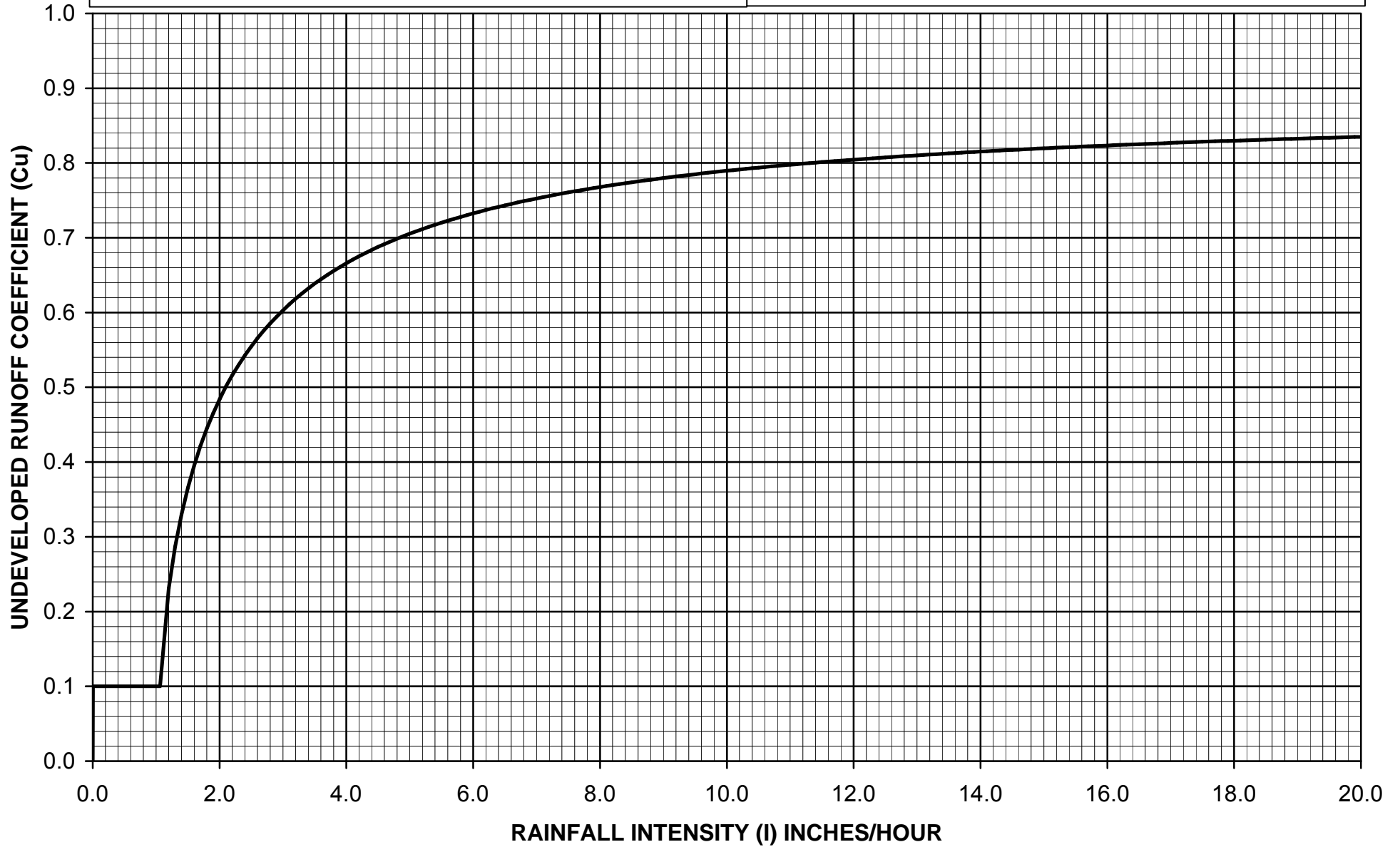

$C_D = (0.9 * IMP) + (1.0 - IMP) * C_U$
 Where: C_D = Developed Runoff Coefficient
 IMP = Proportion Impervious
 C_U = Undeveloped runoff coefficient



Los Angeles County Department of Public Works

RUNOFF COEFFICIENT CURVE
SOIL TYPE NO. 032

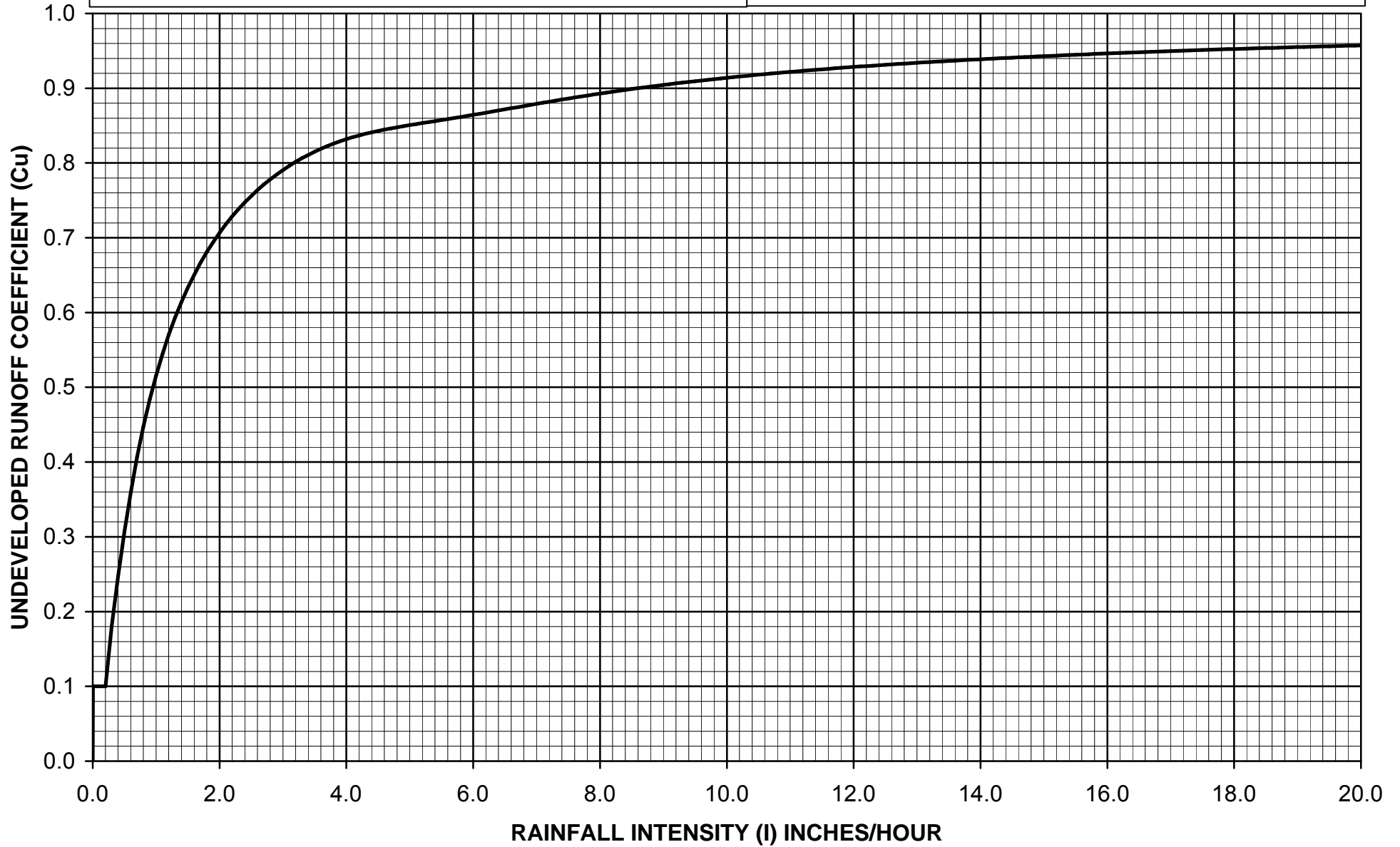

$C_D = (0.9 * IMP) + (1.0 - IMP) * C_U$
 Where: C_D = Developed Runoff Coefficient
 IMP = Proportion Impervious
 C_U = Undeveloped runoff coefficient



Los Angeles County Department of Public Works

RUNOFF COEFFICIENT CURVE
SOIL TYPE NO. 033

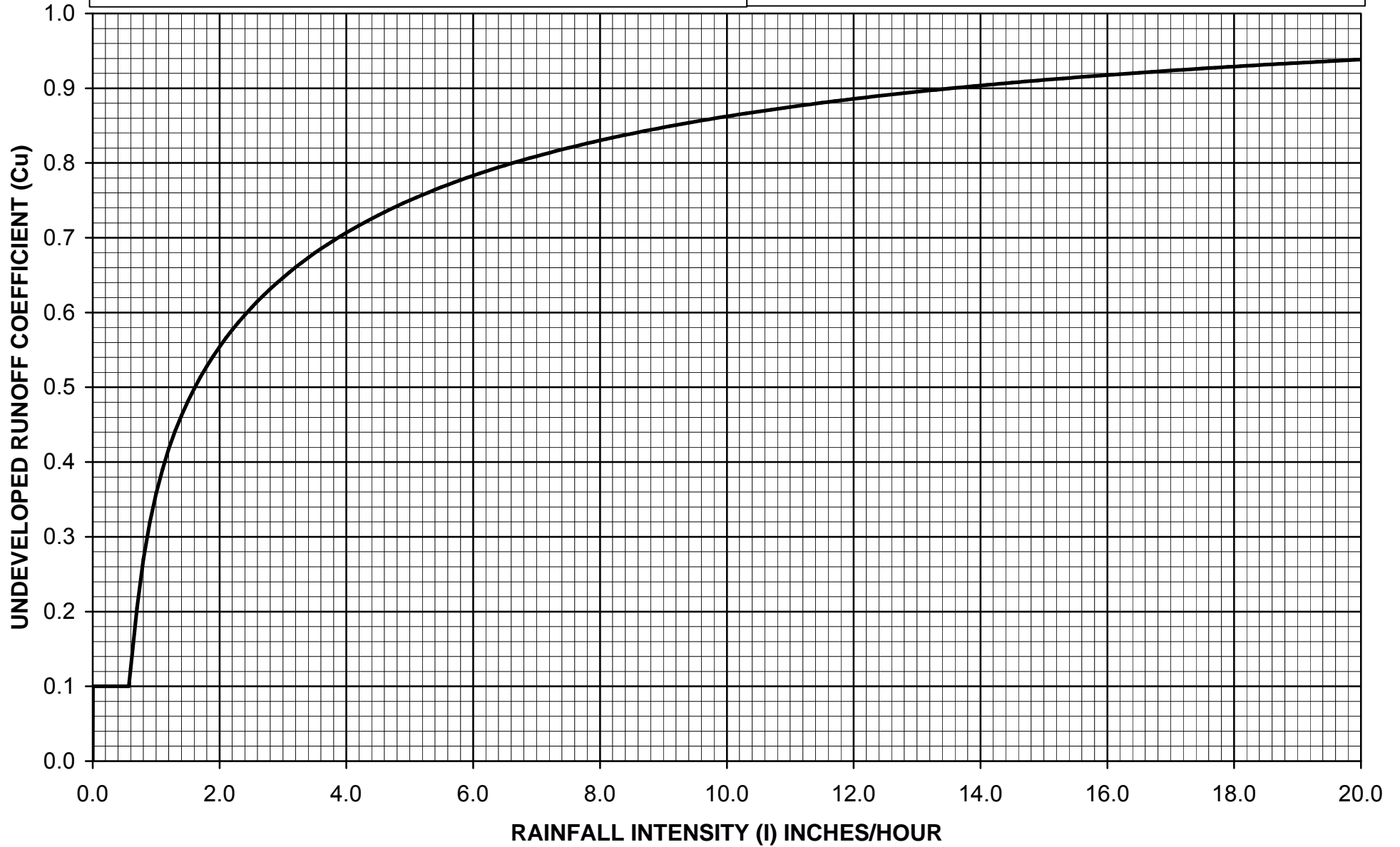

$C_D = (0.9 * IMP) + (1.0 - IMP) * C_U$
 Where: C_D = Developed Runoff Coefficient
 IMP = Proportion Impervious
 C_U = Undeveloped runoff coefficient



Los Angeles County Department of Public Works

RUNOFF COEFFICIENT CURVE
SOIL TYPE NO. 034

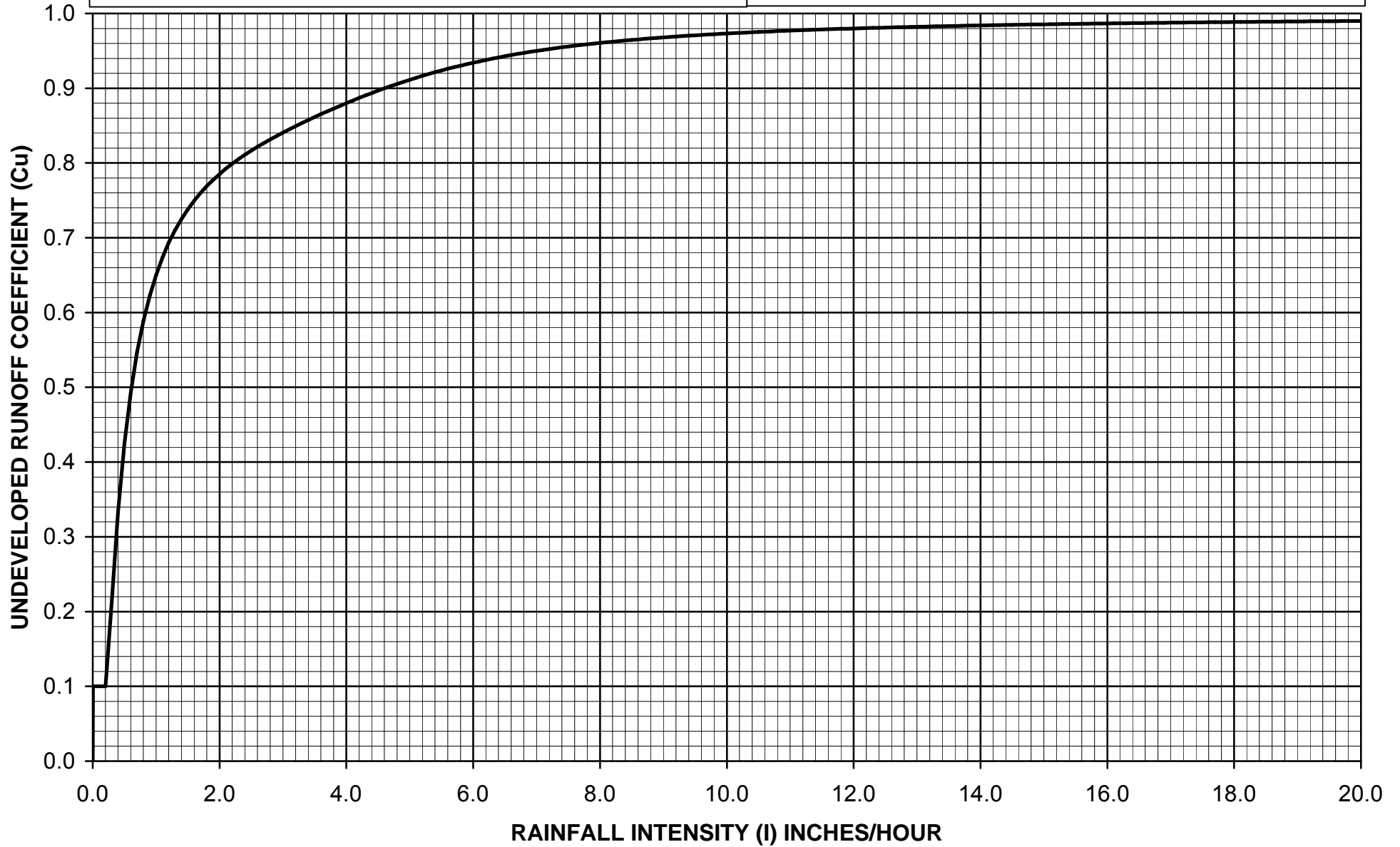

$C_D = (0.9 * IMP) + (1.0 - IMP) * C_U$
 Where: C_D = Developed Runoff Coefficient
 IMP = Proportion Impervious
 C_U = Undeveloped runoff coefficient



Los Angeles County Department of Public Works

RUNOFF COEFFICIENT CURVE
SOIL TYPE NO. 035

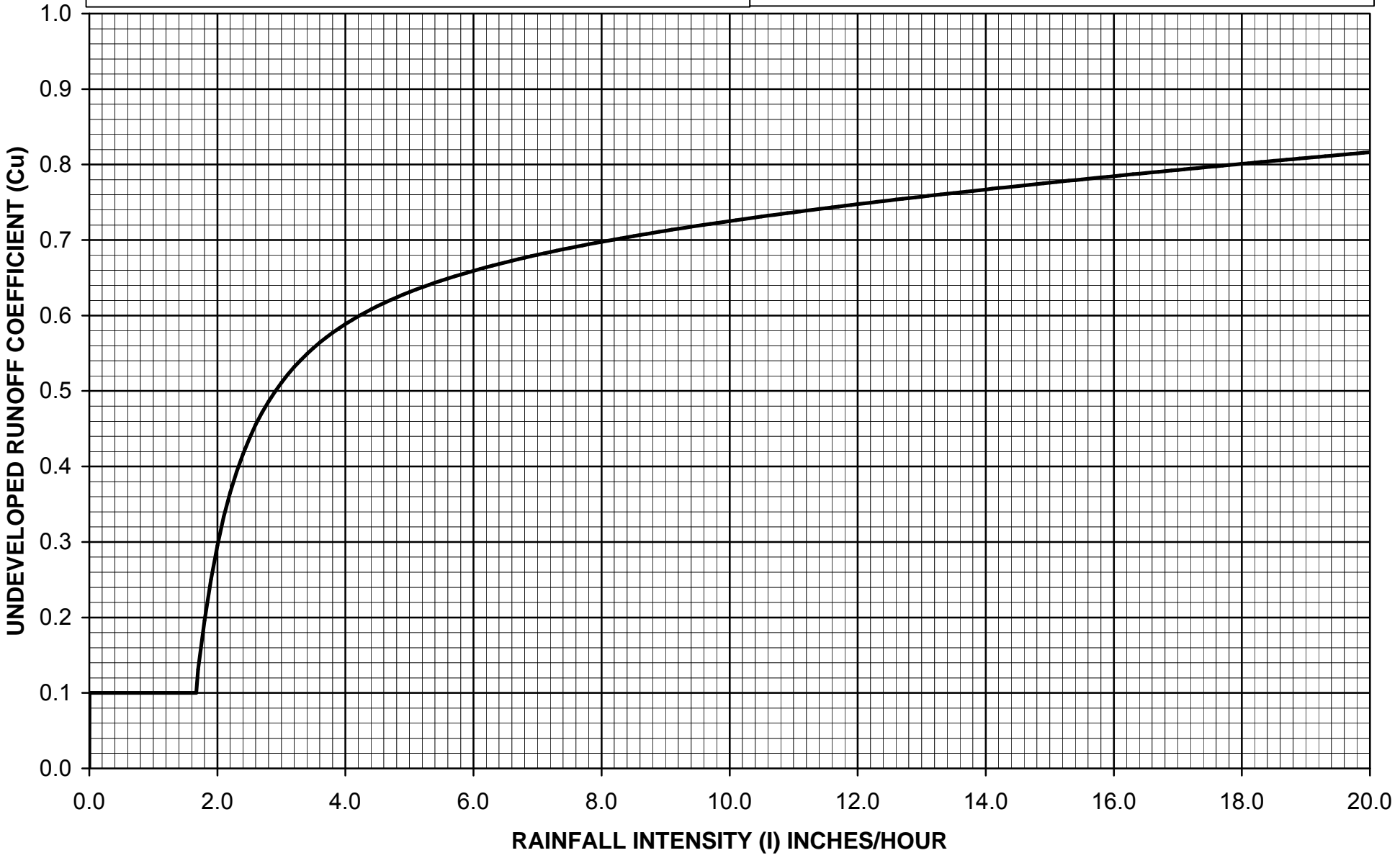

$C_D = (0.9 * IMP) + (1.0 - IMP) * C_U$
 Where: C_D = Developed Runoff Coefficient
 IMP = Proportion Impervious
 C_U = Undeveloped runoff coefficient



Los Angeles County Department of Public Works

RUNOFF COEFFICIENT CURVE
SOIL TYPE NO. 036

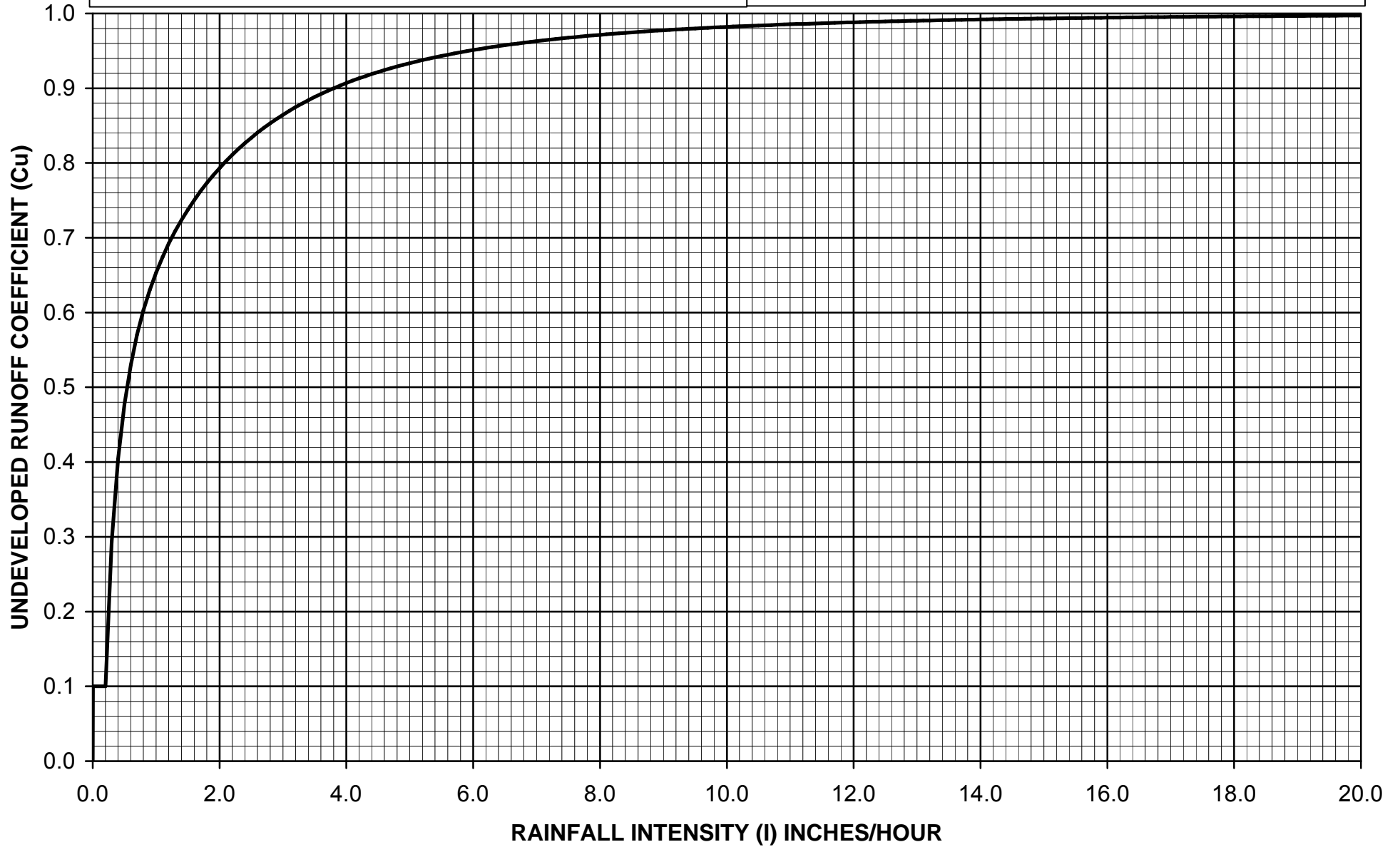

$C_D = (0.9 * IMP) + (1.0 - IMP) * C_U$
 Where: C_D = Developed Runoff Coefficient
 IMP = Proportion Impervious
 C_U = Undeveloped runoff coefficient



Los Angeles County Department of Public Works

RUNOFF COEFFICIENT CURVE
SOIL TYPE NO. 037

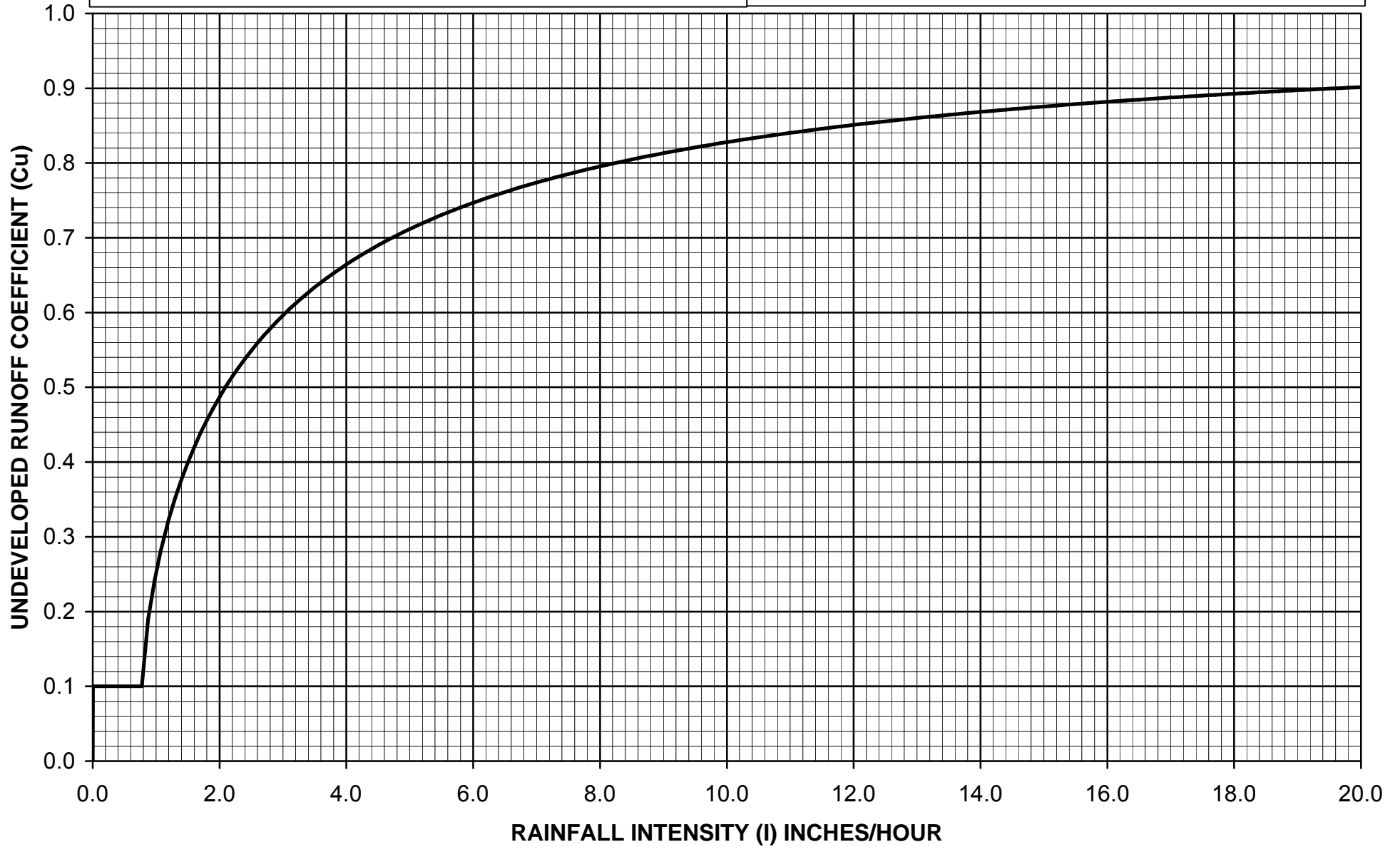

$C_D = (0.9 * IMP) + (1.0 - IMP) * C_U$
 Where: C_D = Developed Runoff Coefficient
 IMP = Proportion Impervious
 C_U = Undeveloped runoff coefficient



Los Angeles County Department of Public Works

RUNOFF COEFFICIENT CURVE
SOIL TYPE NO. 038

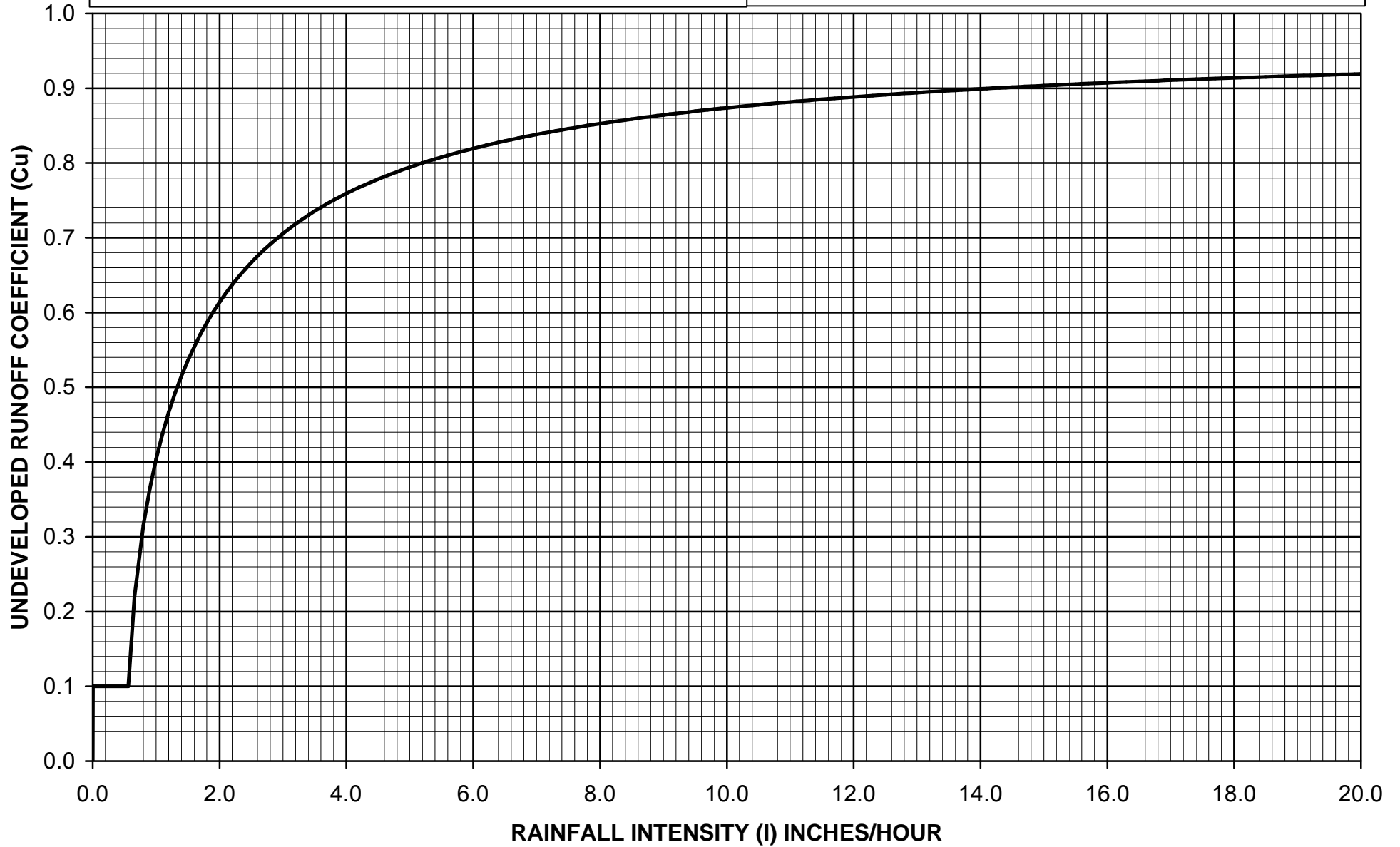

$C_D = (0.9 * IMP) + (1.0 - IMP) * C_U$
 Where: C_D = Developed Runoff Coefficient
 IMP = Proportion Impervious
 C_U = Undeveloped runoff coefficient



Los Angeles County Department of Public Works

RUNOFF COEFFICIENT CURVE
SOIL TYPE NO. 039

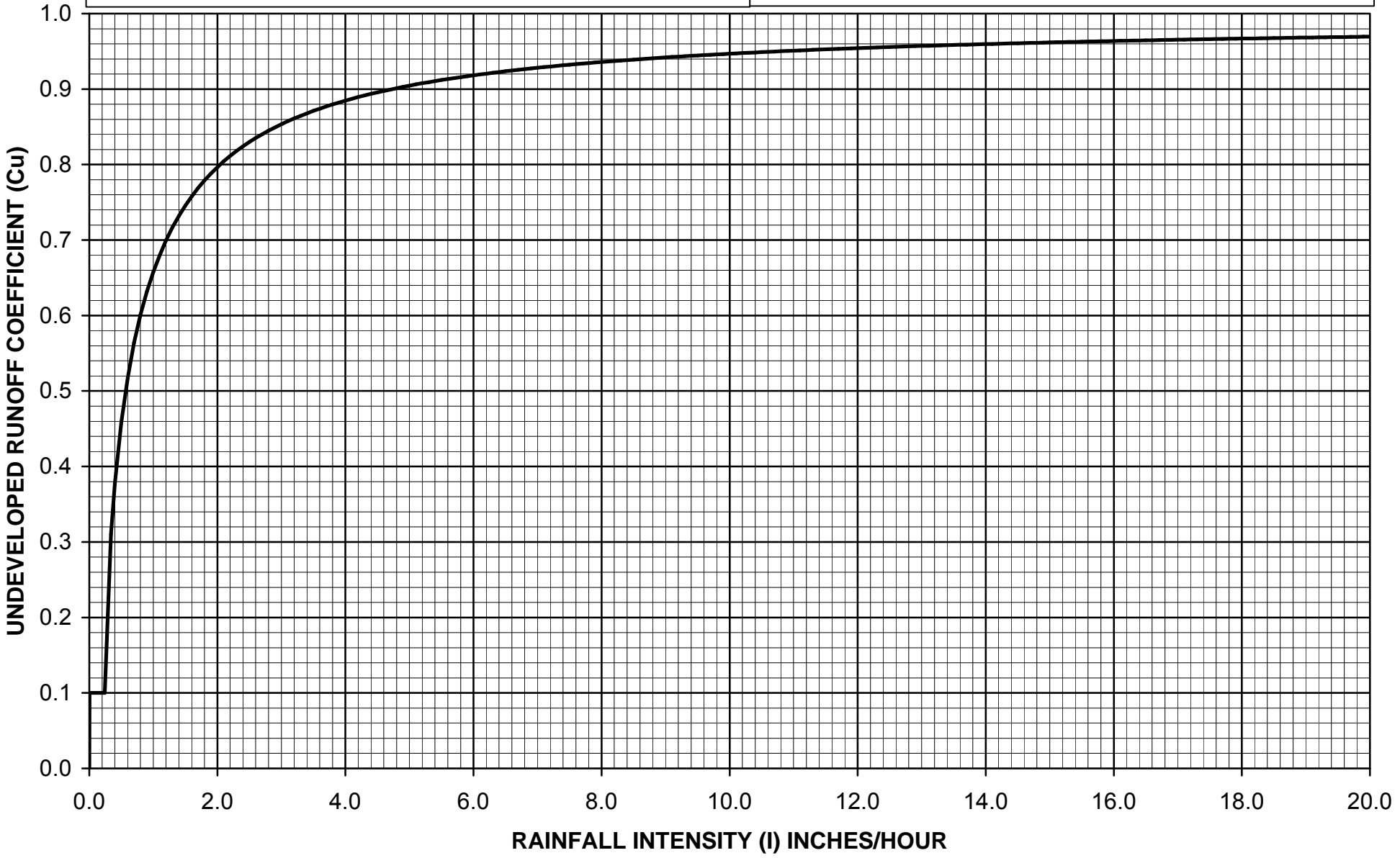

$C_D = (0.9 * IMP) + (1.0 - IMP) * C_U$
 Where: C_D = Developed Runoff Coefficient
 IMP = Proportion Impervious
 C_U = Undeveloped runoff coefficient



Los Angeles County Department of Public Works

RUNOFF COEFFICIENT CURVE
SOIL TYPE NO. 040

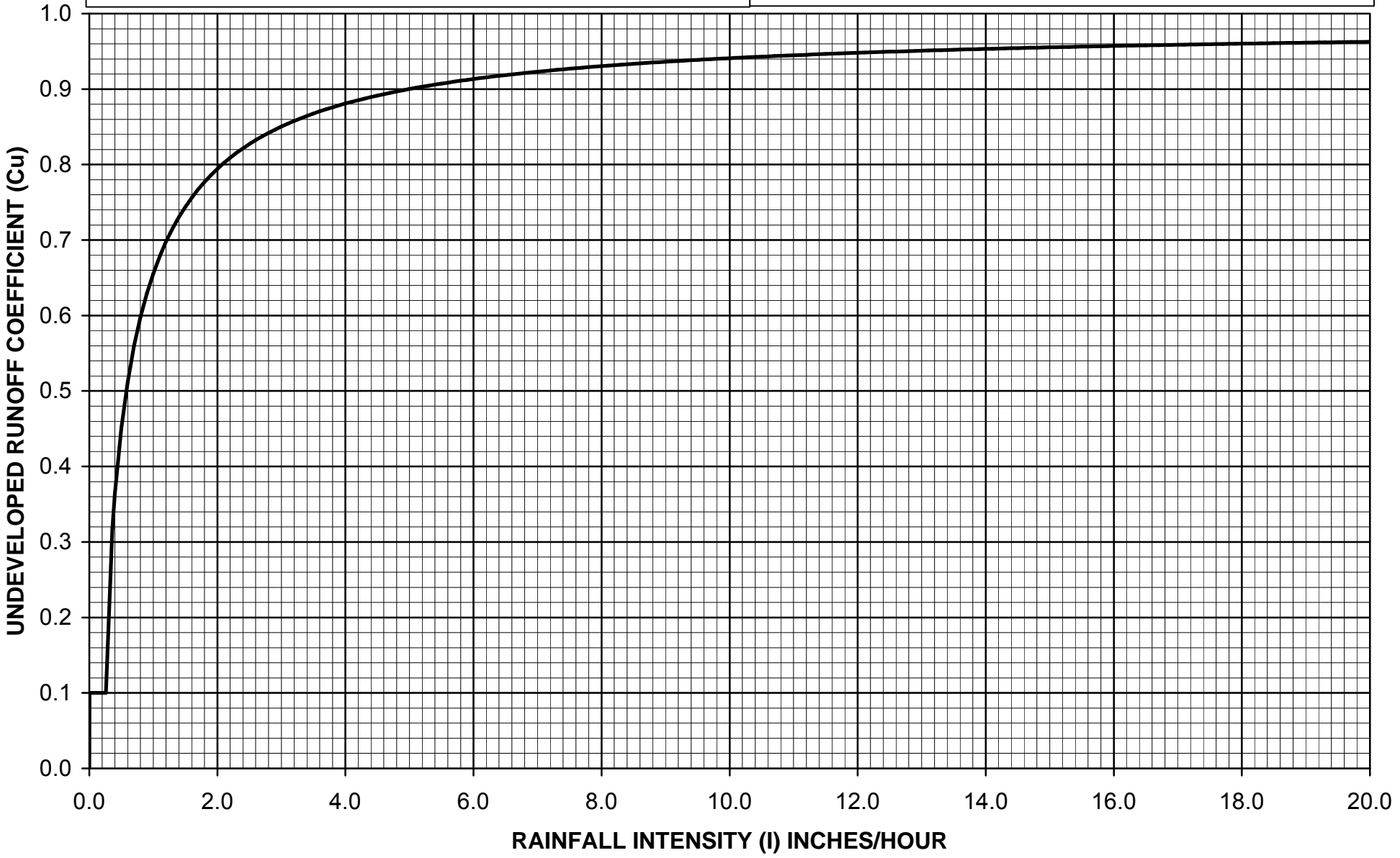

$C_D = (0.9 * IMP) + (1.0 - IMP) * C_U$
 Where: C_D = Developed Runoff Coefficient
 IMP = Proportion Impervious
 C_U = Undeveloped runoff coefficient



Los Angeles County Department of Public Works

RUNOFF COEFFICIENT CURVE
SOIL TYPE NO. 041

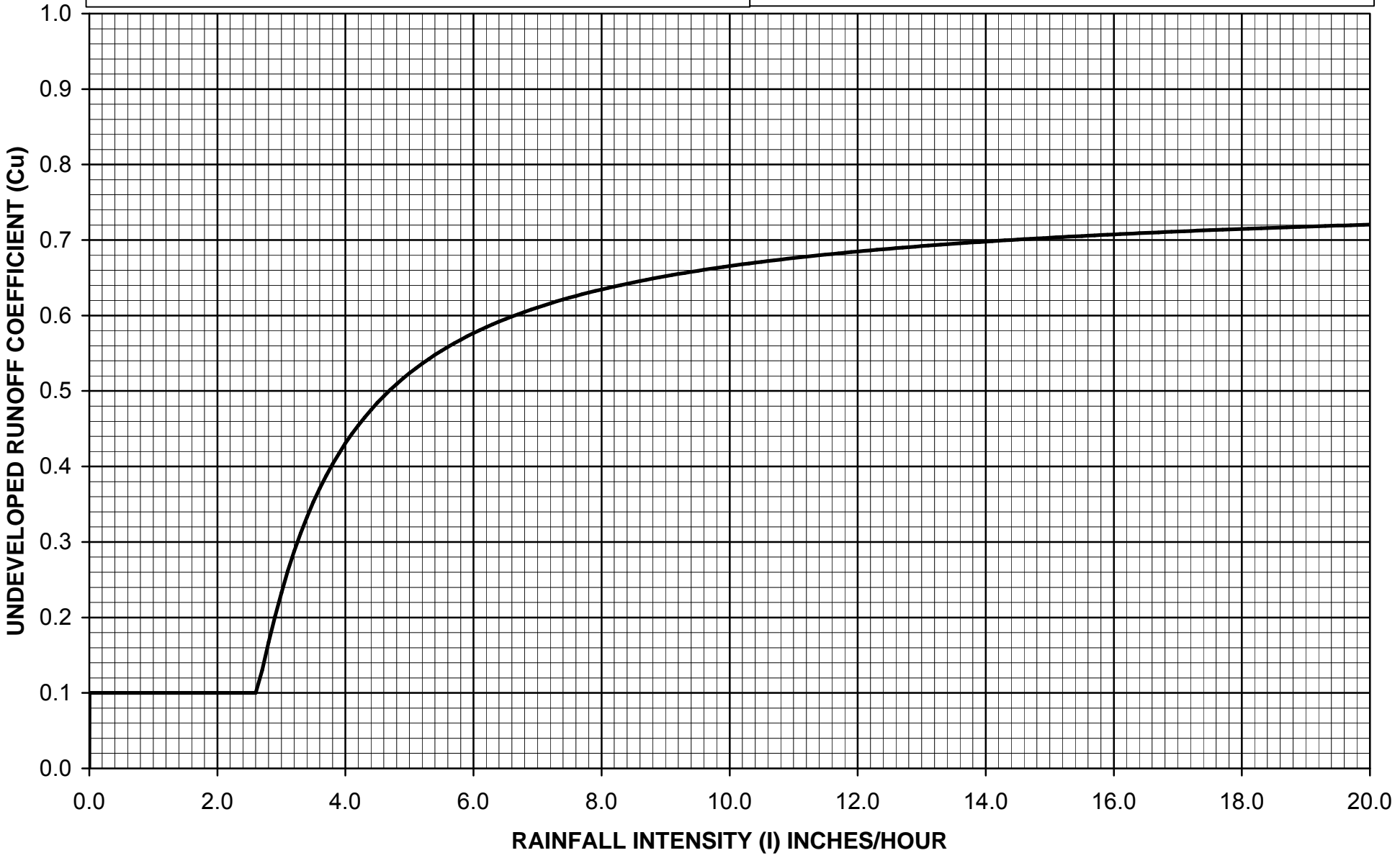

$C_D = (0.9 * IMP) + (1.0 - IMP) * C_U$
 Where: C_D = Developed Runoff Coefficient
 IMP = Proportion Impervious
 C_U = Undeveloped runoff coefficient



Los Angeles County Department of Public Works

RUNOFF COEFFICIENT CURVE
SOIL TYPE NO. 042

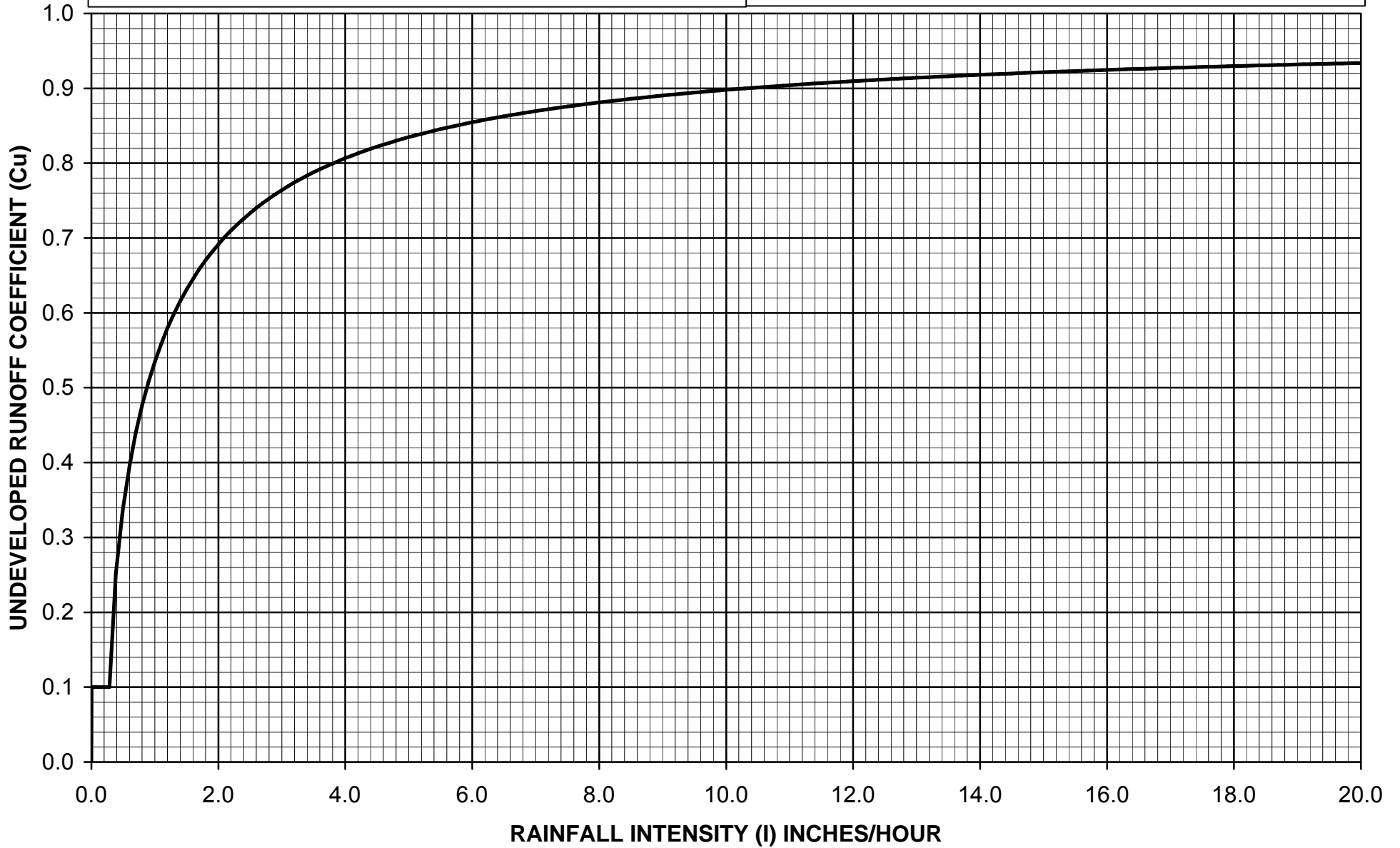

$C_D = (0.9 * IMP) + (1.0 - IMP) * C_U$
 Where: C_D = Developed Runoff Coefficient
 IMP = Proportion Impervious
 C_U = Undeveloped runoff coefficient



Los Angeles County Department of Public Works

RUNOFF COEFFICIENT CURVE
SOIL TYPE NO. 043

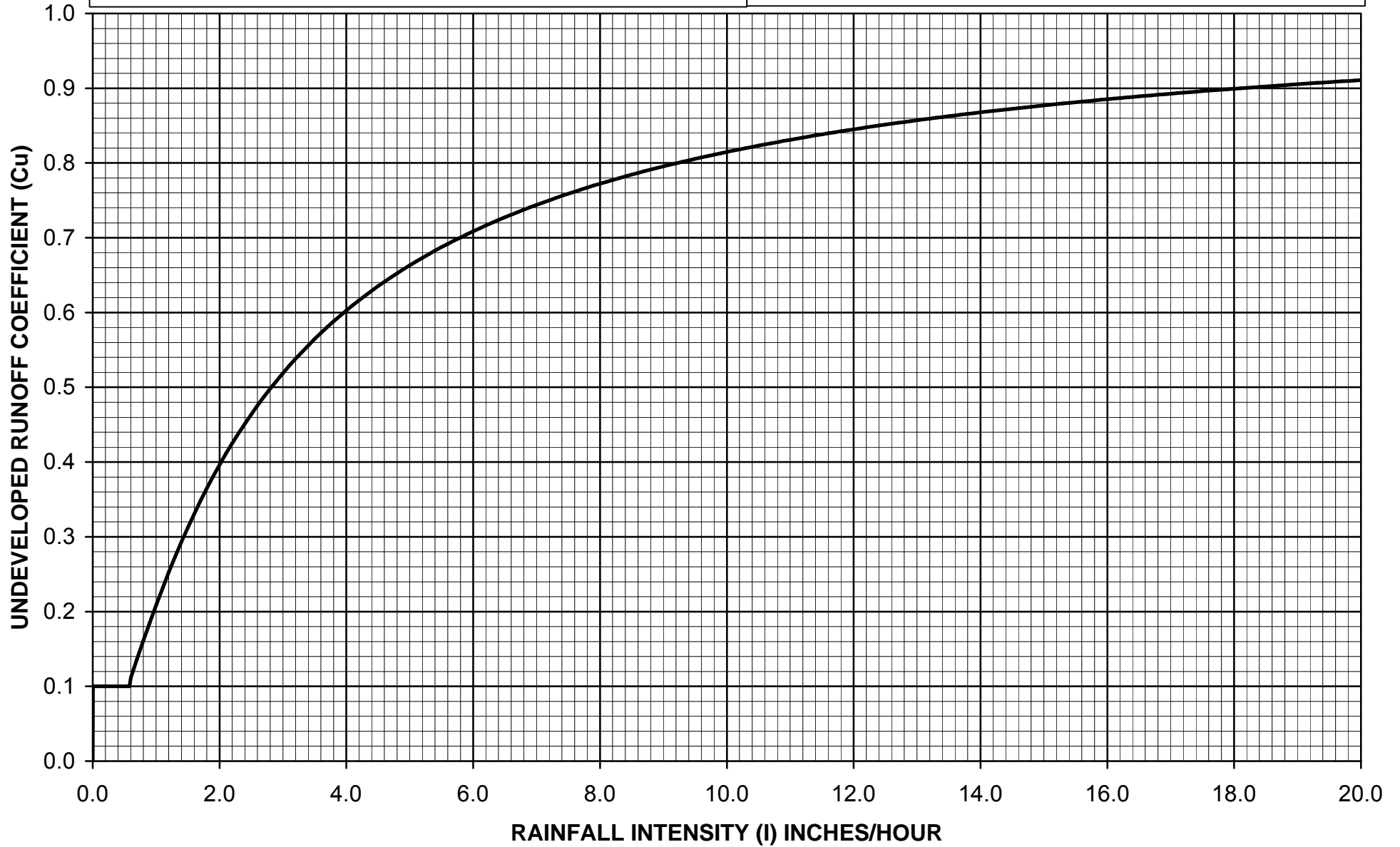

$C_D = (0.9 * IMP) + (1.0 - IMP) * C_U$
 Where: C_D = Developed Runoff Coefficient
 IMP = Proportion Impervious
 C_U = Undeveloped runoff coefficient



Los Angeles County Department of Public Works

RUNOFF COEFFICIENT CURVE
SOIL TYPE NO. 044

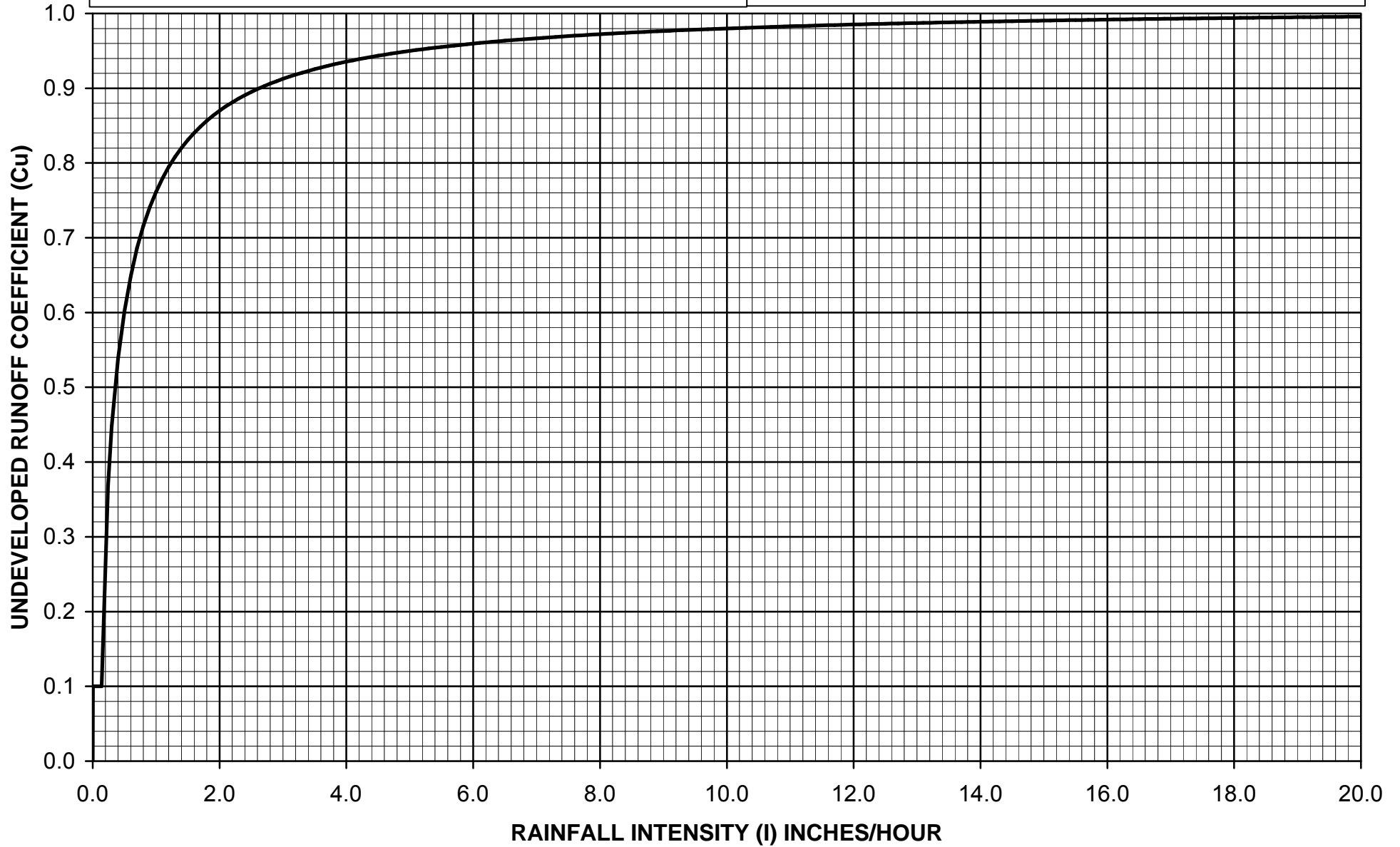

$C_D = (0.9 * IMP) + (1.0 - IMP) * C_U$
 Where: C_D = Developed Runoff Coefficient
 IMP = Proportion Impervious
 C_U = Undeveloped runoff coefficient



Los Angeles County Department of Public Works

RUNOFF COEFFICIENT CURVE
SOIL TYPE NO. 045

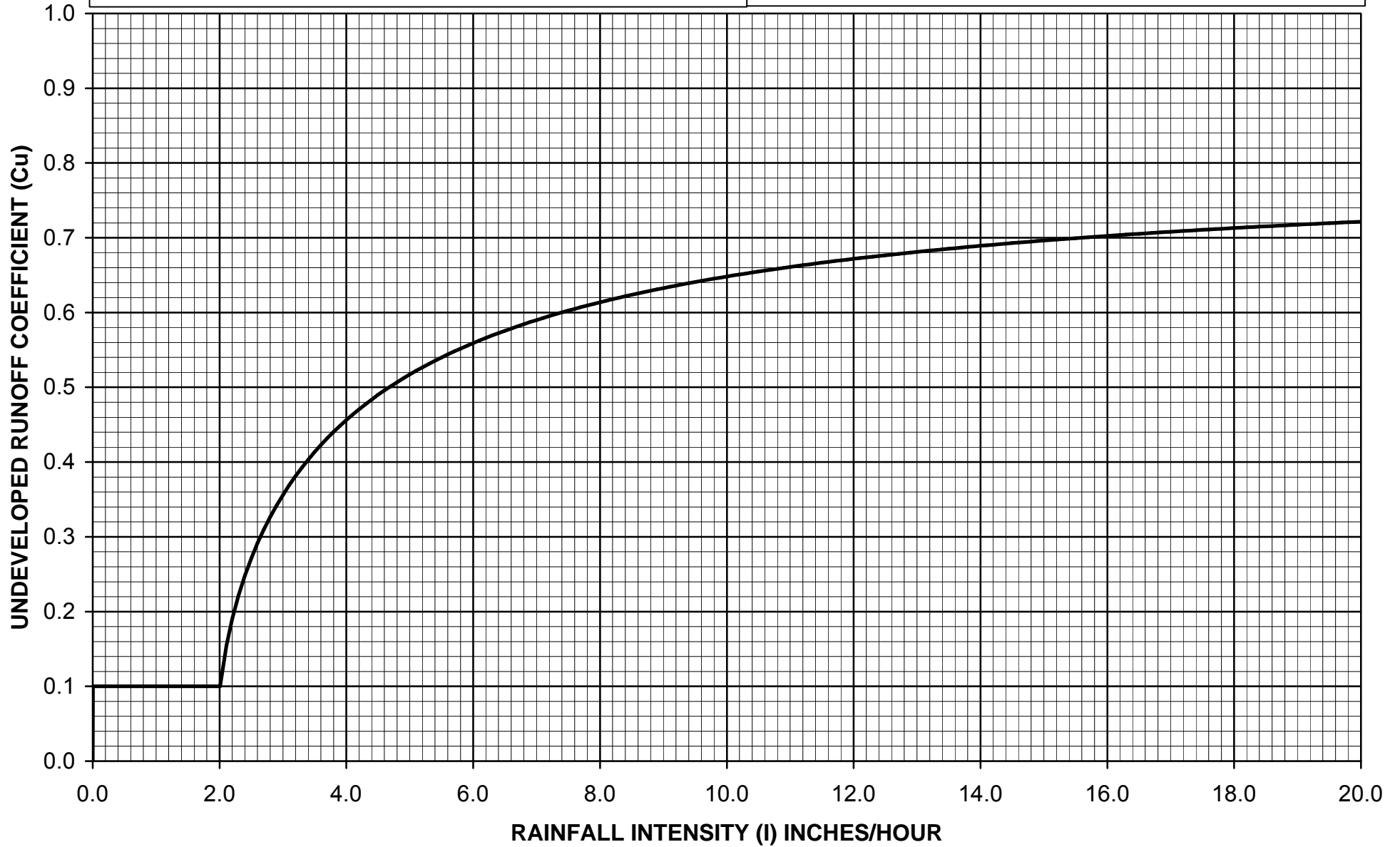

$C_D = (0.9 * IMP) + (1.0 - IMP) * C_U$
 Where: C_D = Developed Runoff Coefficient
 IMP = Proportion Impervious
 C_U = Undeveloped runoff coefficient



Los Angeles County Department of Public Works

RUNOFF COEFFICIENT CURVE
SOIL TYPE NO. 046

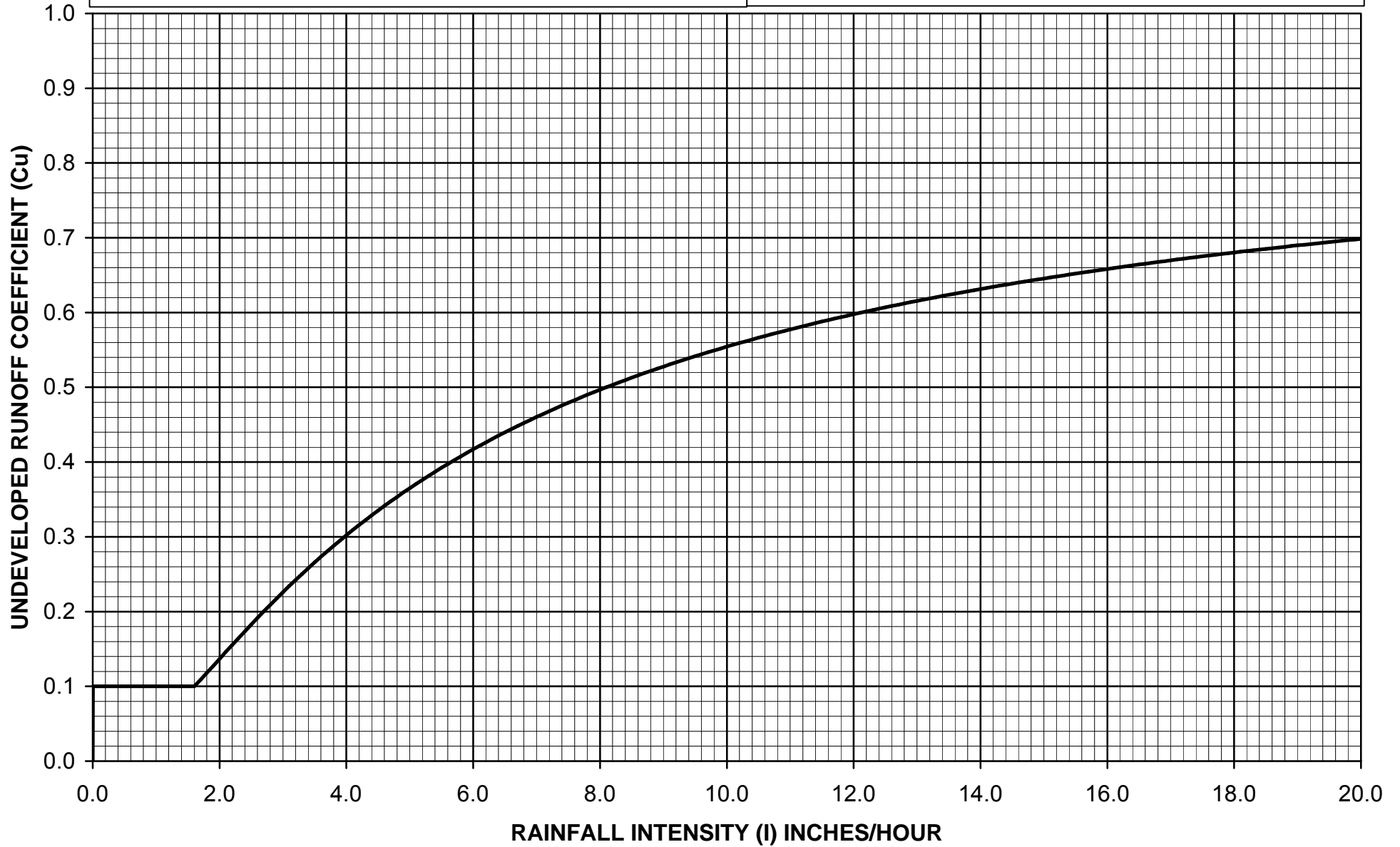

$C_D = (0.9 * IMP) + (1.0 - IMP) * C_U$
 Where: C_D = Developed Runoff Coefficient
 IMP = Proportion Impervious
 C_U = Undeveloped runoff coefficient



Los Angeles County Department of Public Works

RUNOFF COEFFICIENT CURVE
SOIL TYPE NO. 047

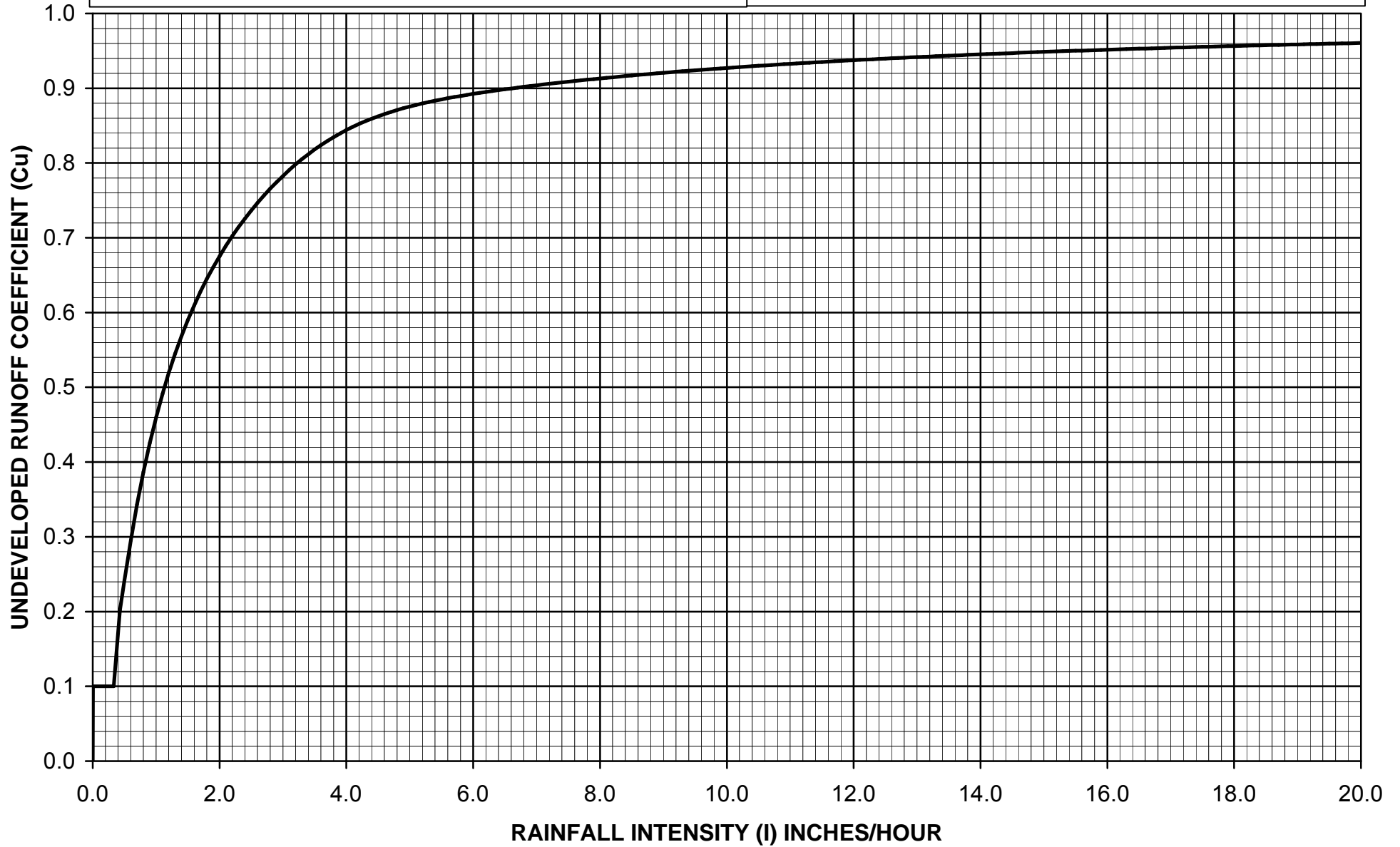

$C_D = (0.9 * IMP) + (1.0 - IMP) * C_U$
 Where: C_D = Developed Runoff Coefficient
 IMP = Proportion Impervious
 C_U = Undeveloped runoff coefficient



Los Angeles County Department of Public Works

RUNOFF COEFFICIENT CURVE
SOIL TYPE NO. 048

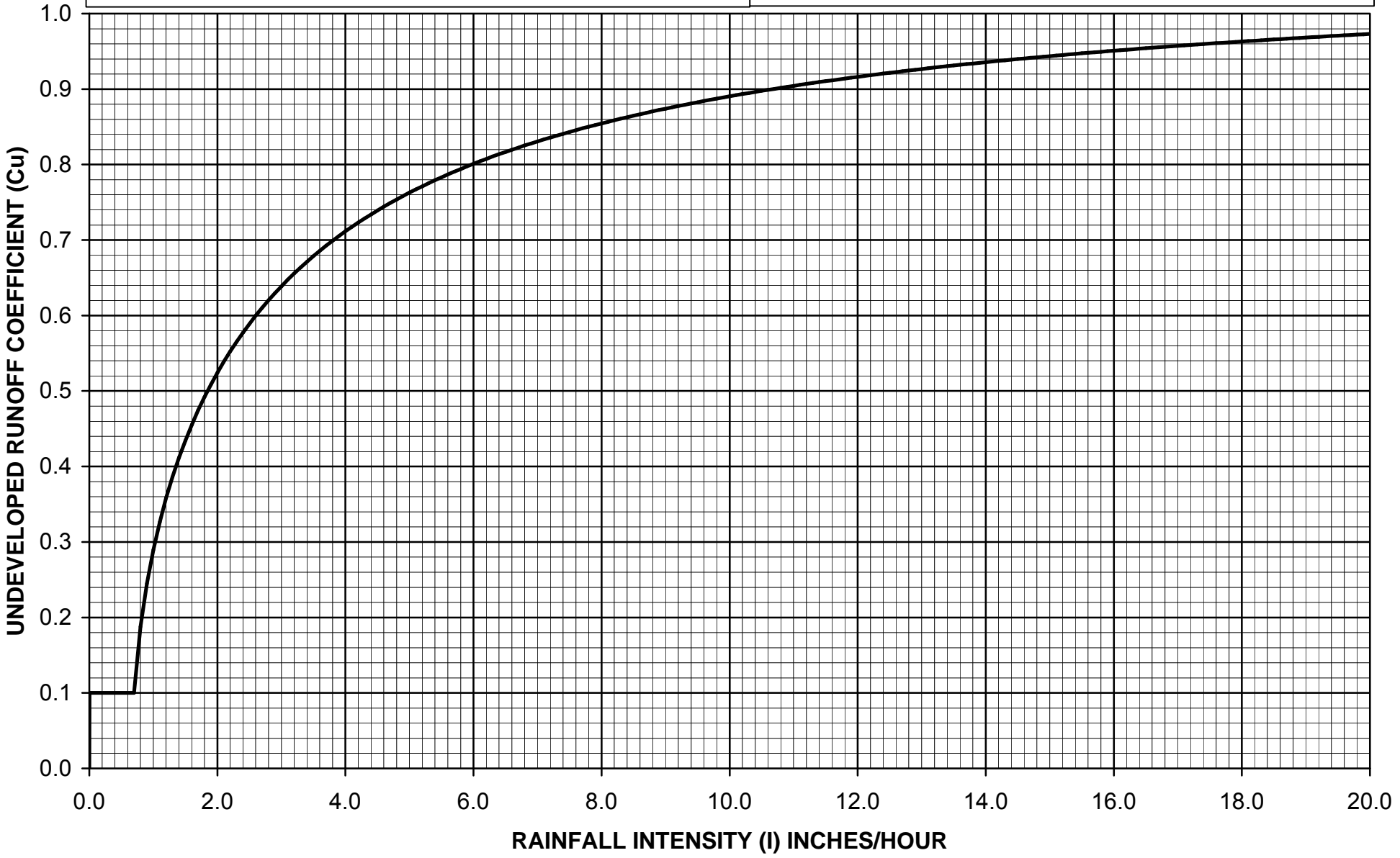

$C_D = (0.9 * IMP) + (1.0 - IMP) * C_U$
 Where: C_D = Developed Runoff Coefficient
 IMP = Proportion Impervious
 C_U = Undeveloped runoff coefficient



Los Angeles County Department of Public Works

RUNOFF COEFFICIENT CURVE
SOIL TYPE NO. 049

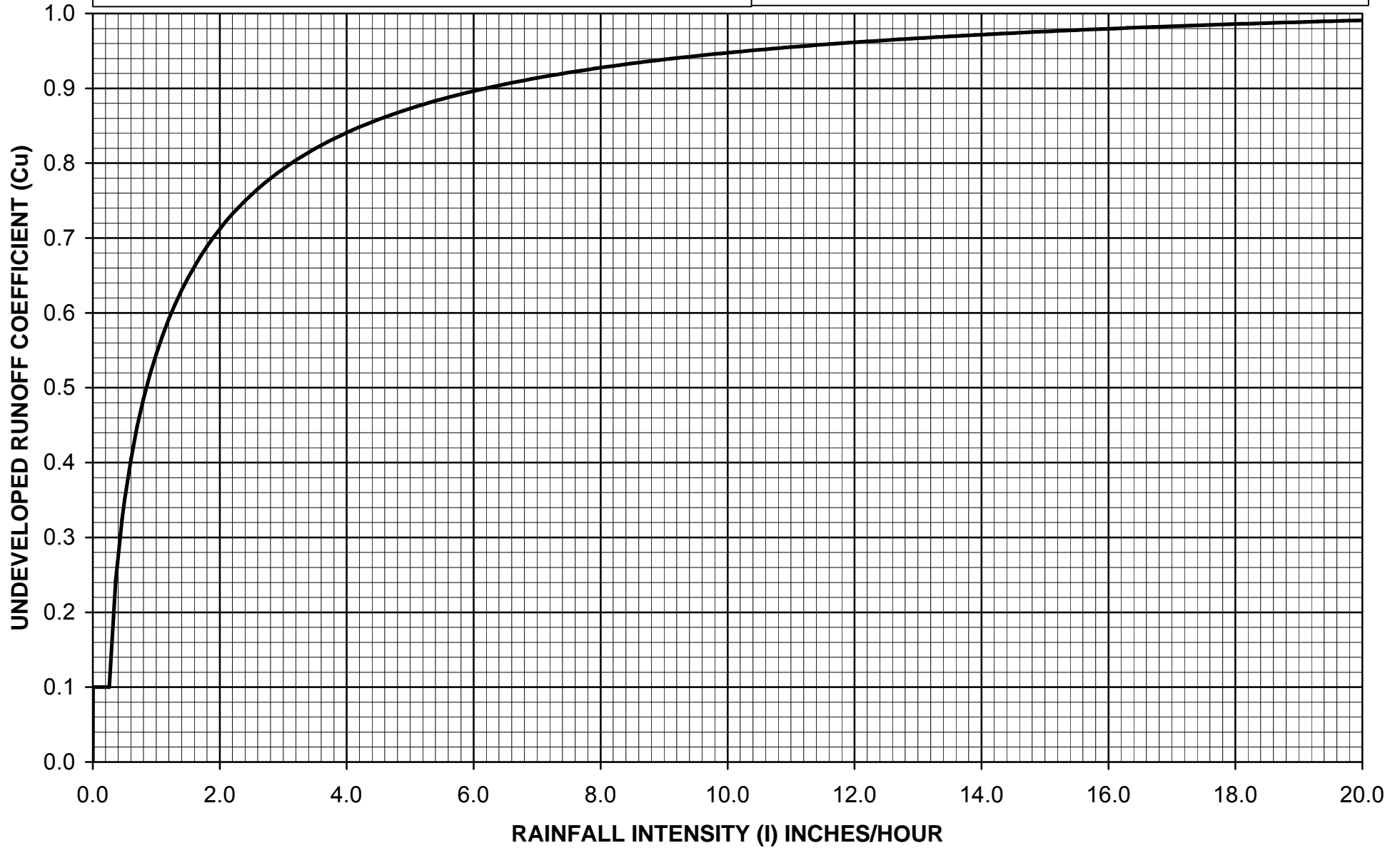

$C_D = (0.9 * IMP) + (1.0 - IMP) * C_U$
 Where: C_D = Developed Runoff Coefficient
 IMP = Proportion Impervious
 C_U = Undeveloped runoff coefficient



Los Angeles County Department of Public Works

**RUNOFF COEFFICIENT CURVE
SOIL TYPE NO. 050**

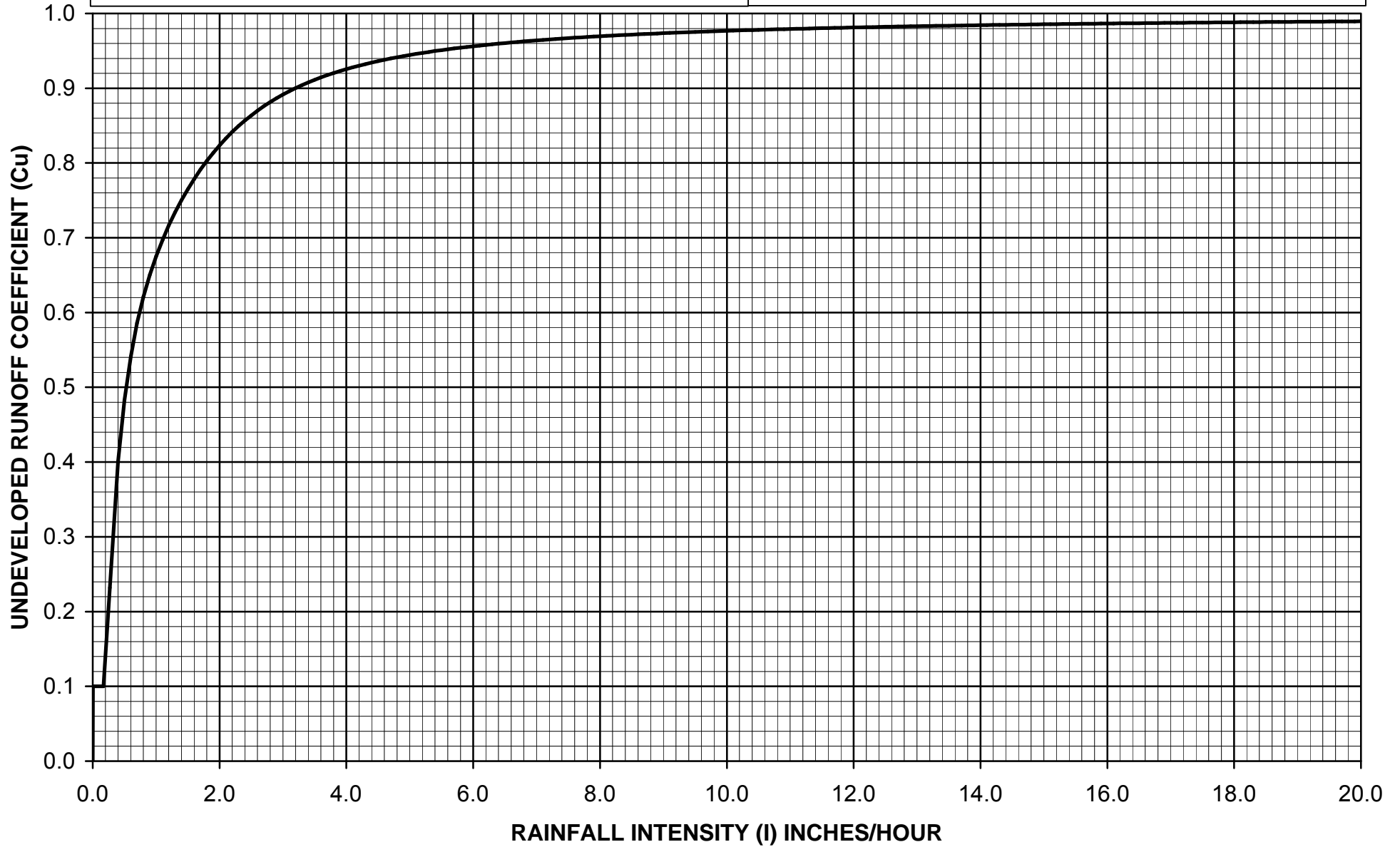

$C_D = (0.9 * IMP) + (1.0 - IMP) * C_U$
 Where: C_D = Developed Runoff Coefficient
 IMP = Proportion Impervious
 C_U = Undeveloped runoff coefficient



Los Angeles County Department of Public Works

RUNOFF COEFFICIENT CURVE
SOIL TYPE NO. 051

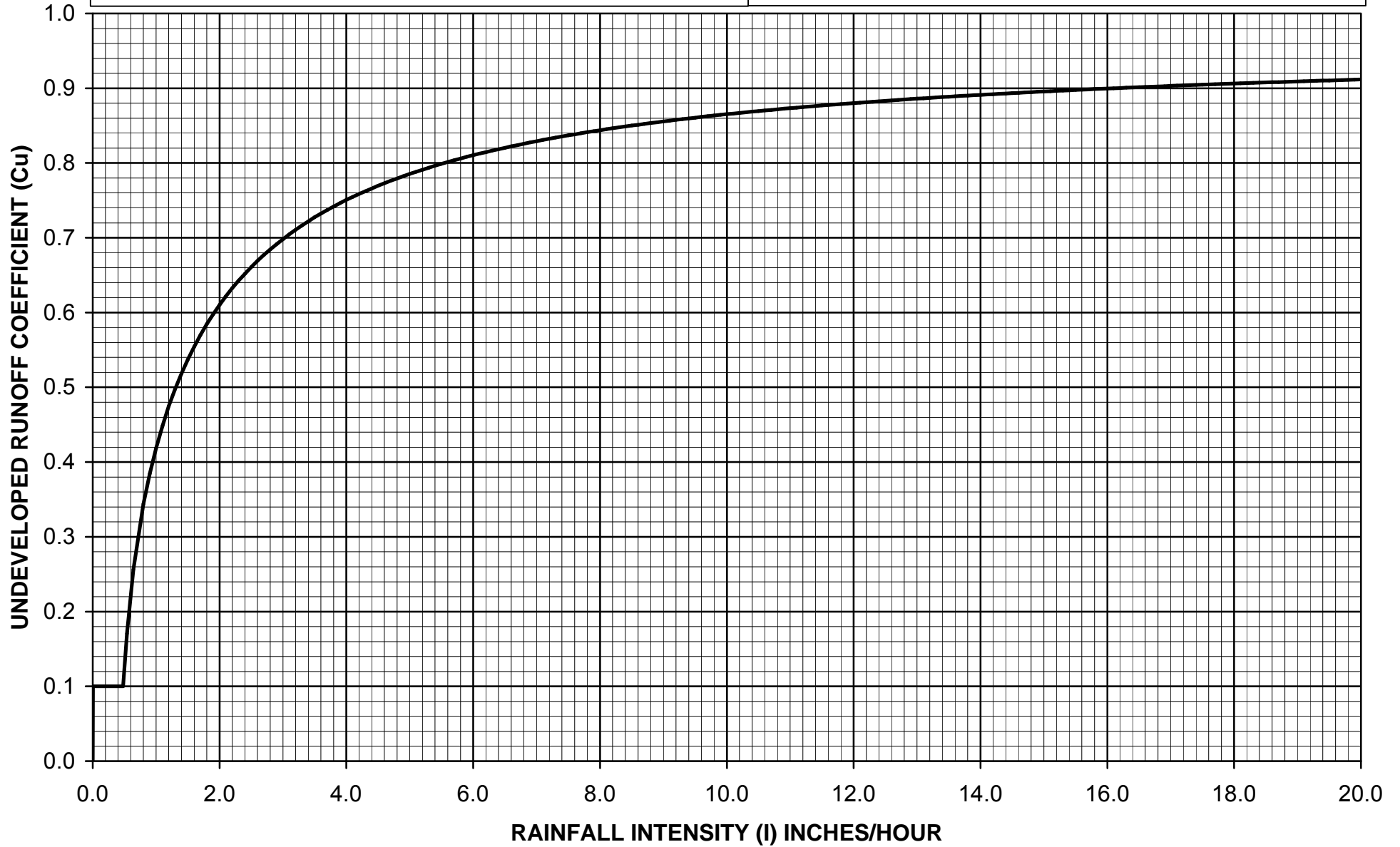

$C_D = (0.9 * IMP) + (1.0 - IMP) * C_U$
 Where: C_D = Developed Runoff Coefficient
 IMP = Proportion Impervious
 C_U = Undeveloped runoff coefficient



Los Angeles County Department of Public Works

RUNOFF COEFFICIENT CURVE
SOIL TYPE NO. 052

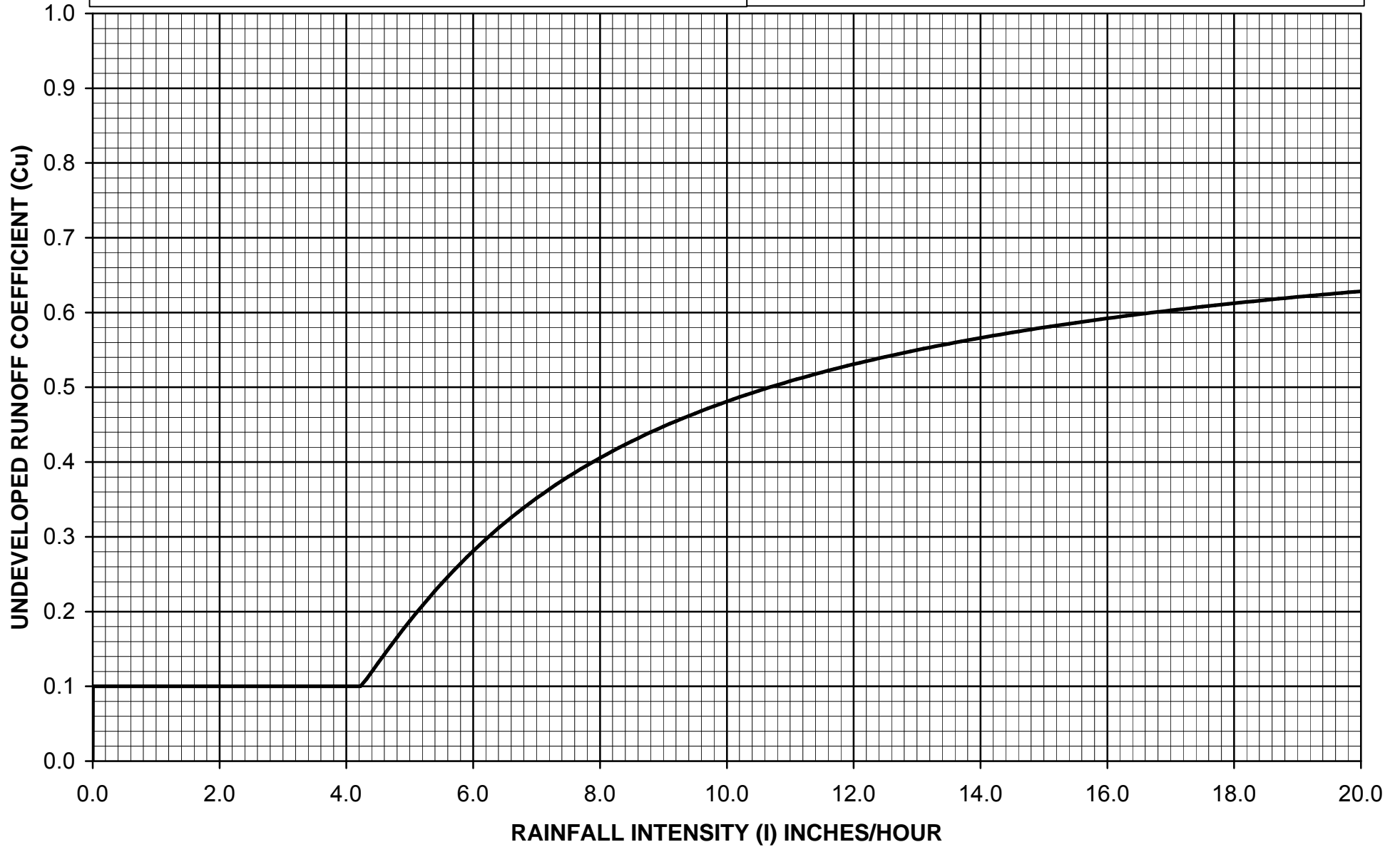

$C_D = (0.9 * IMP) + (1.0 - IMP) * C_U$
 Where: C_D = Developed Runoff Coefficient
 IMP = Proportion Impervious
 C_U = Undeveloped runoff coefficient



Los Angeles County Department of Public Works

RUNOFF COEFFICIENT CURVE
SOIL TYPE NO. 053

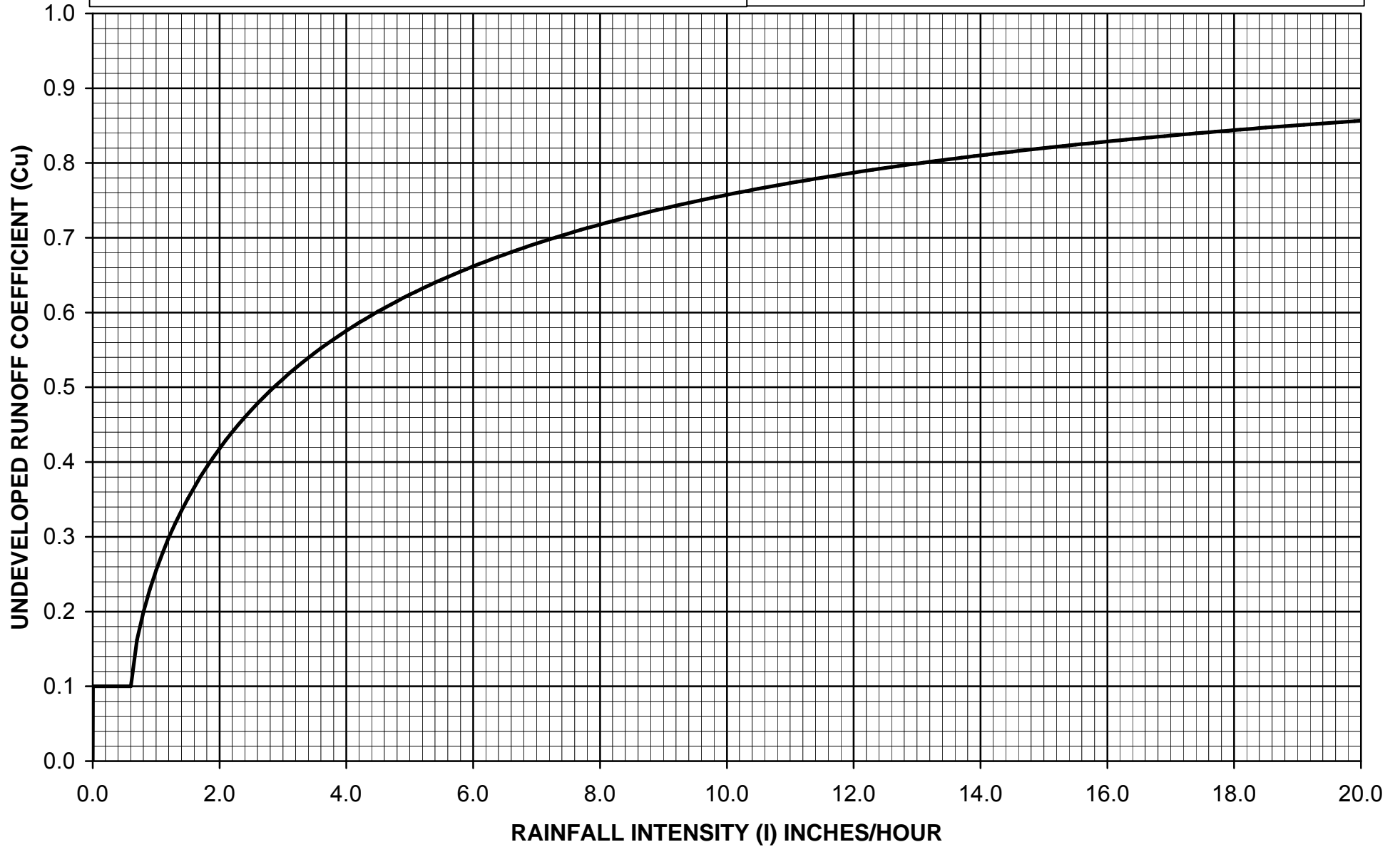

$C_D = (0.9 * IMP) + (1.0 - IMP) * C_U$
 Where: C_D = Developed Runoff Coefficient
 IMP = Proportion Impervious
 C_U = Undeveloped runoff coefficient



Los Angeles County Department of Public Works

RUNOFF COEFFICIENT CURVE
SOIL TYPE NO. 054

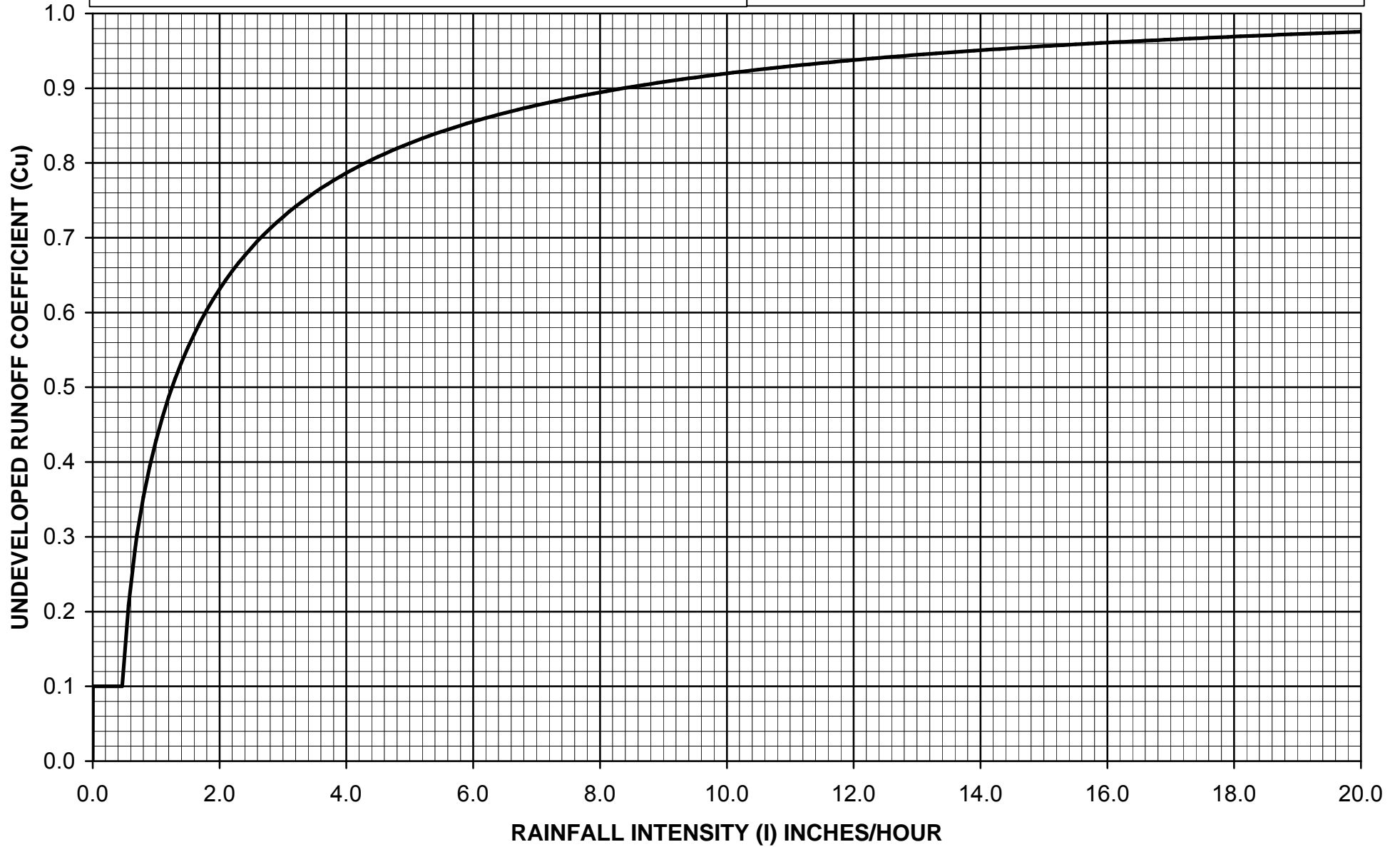

$C_D = (0.9 * IMP) + (1.0 - IMP) * C_U$
 Where: C_D = Developed Runoff Coefficient
 IMP = Proportion Impervious
 C_U = Undeveloped runoff coefficient



Los Angeles County Department of Public Works

RUNOFF COEFFICIENT CURVE
SOIL TYPE NO. 055

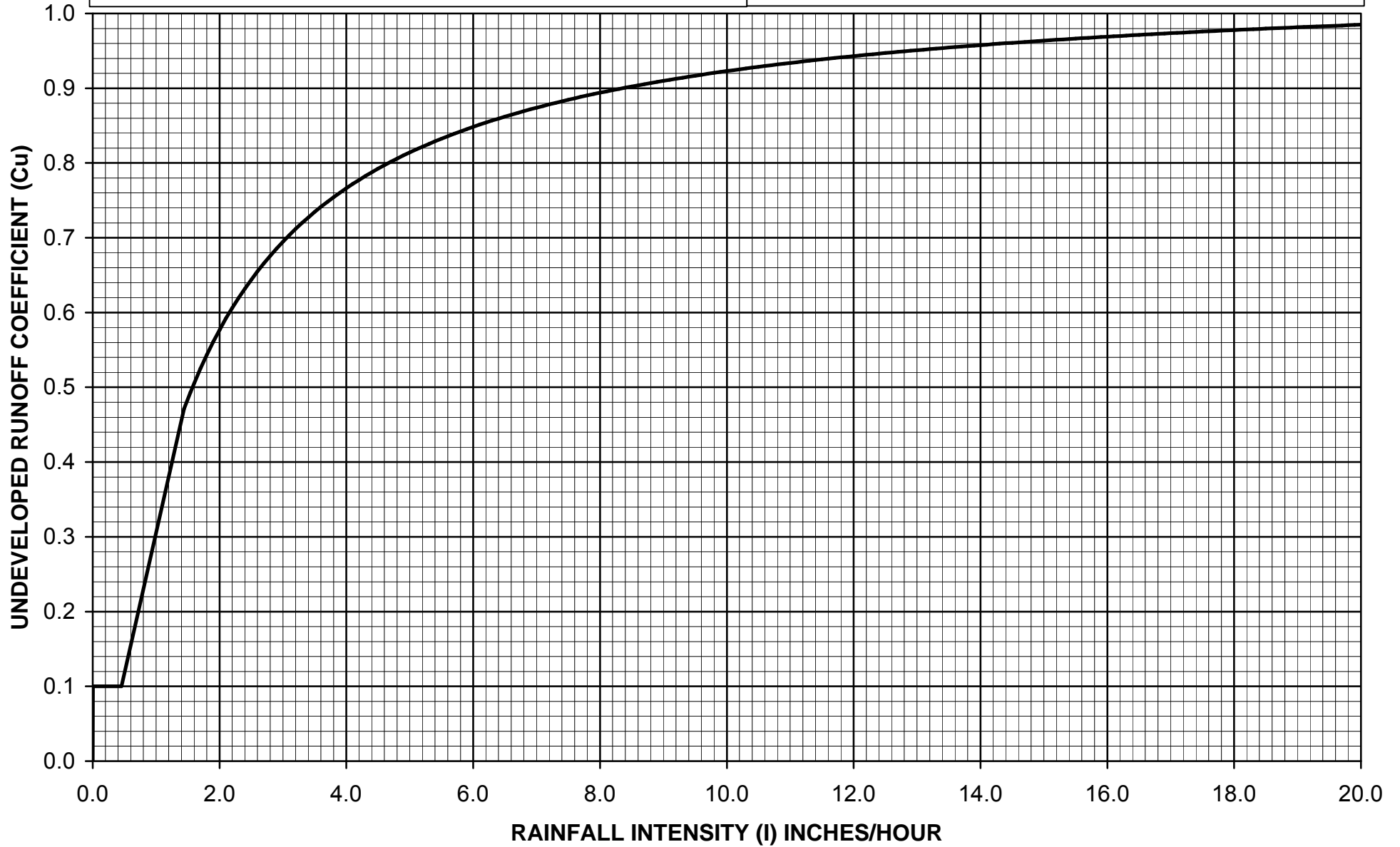

$C_D = (0.9 * IMP) + (1.0 - IMP) * C_U$
 Where: C_D = Developed Runoff Coefficient
 IMP = Proportion Impervious
 C_U = Undeveloped runoff coefficient



Los Angeles County Department of Public Works

RUNOFF COEFFICIENT CURVE
SOIL TYPE NO. 056

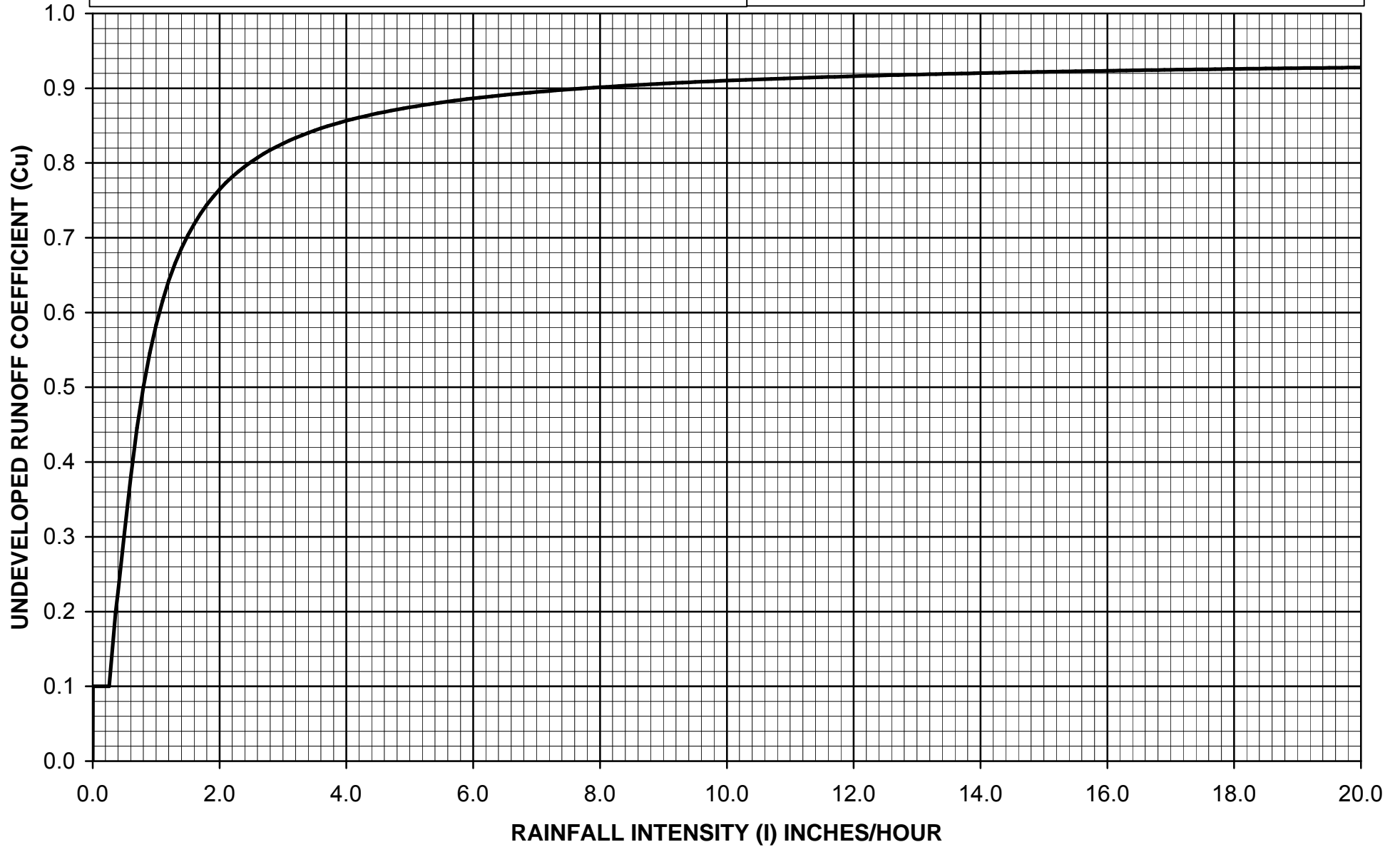

$C_D = (0.9 * IMP) + (1.0 - IMP) * C_U$
 Where: C_D = Developed Runoff Coefficient
 IMP = Proportion Impervious
 C_U = Undeveloped runoff coefficient



Los Angeles County Department of Public Works

RUNOFF COEFFICIENT CURVE
SOIL TYPE NO. 057

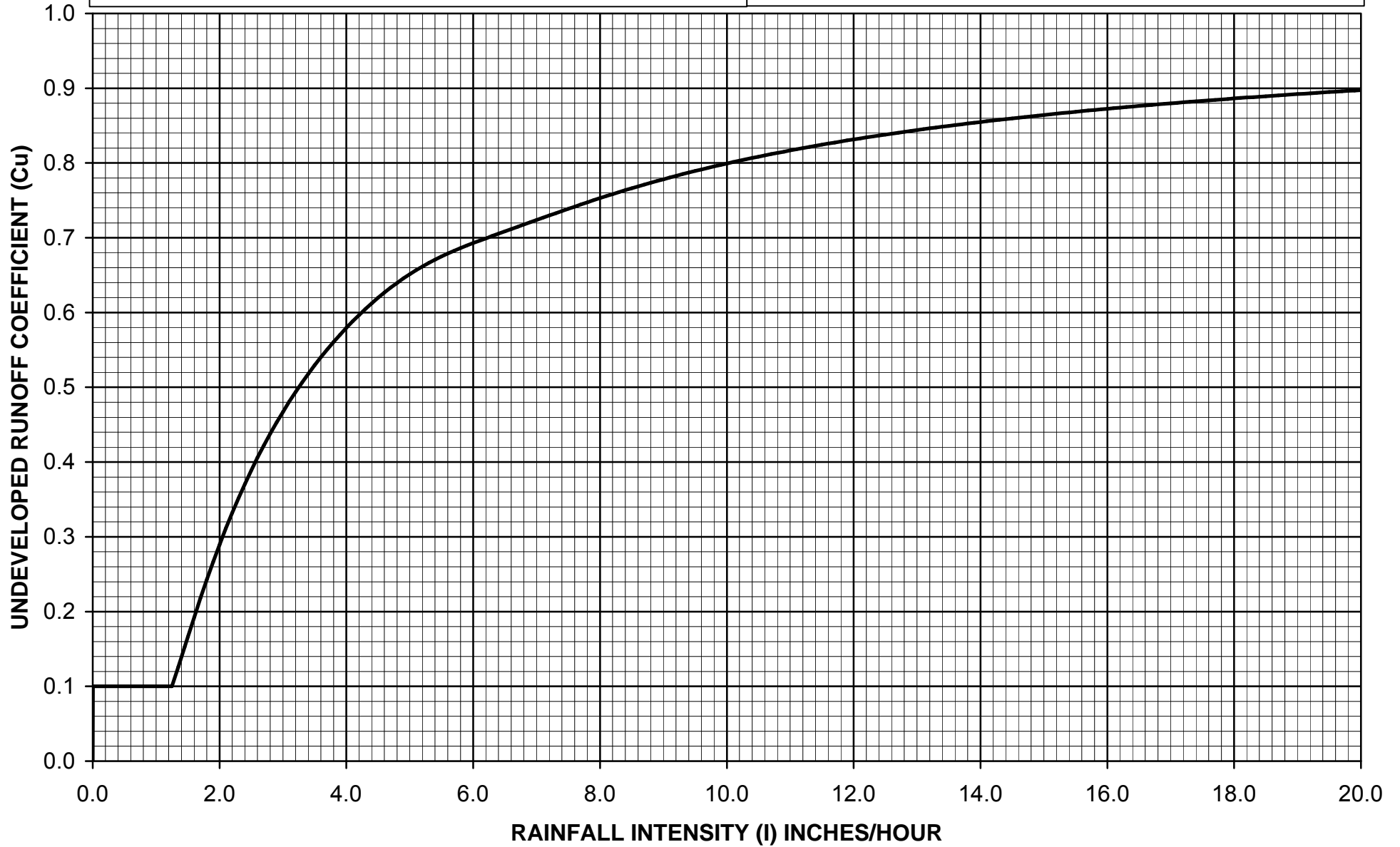

$C_D = (0.9 * IMP) + (1.0 - IMP) * C_U$
 Where: C_D = Developed Runoff Coefficient
 IMP = Proportion Impervious
 C_U = Undeveloped runoff coefficient



Los Angeles County Department of Public Works

RUNOFF COEFFICIENT CURVE
SOIL TYPE NO. 058

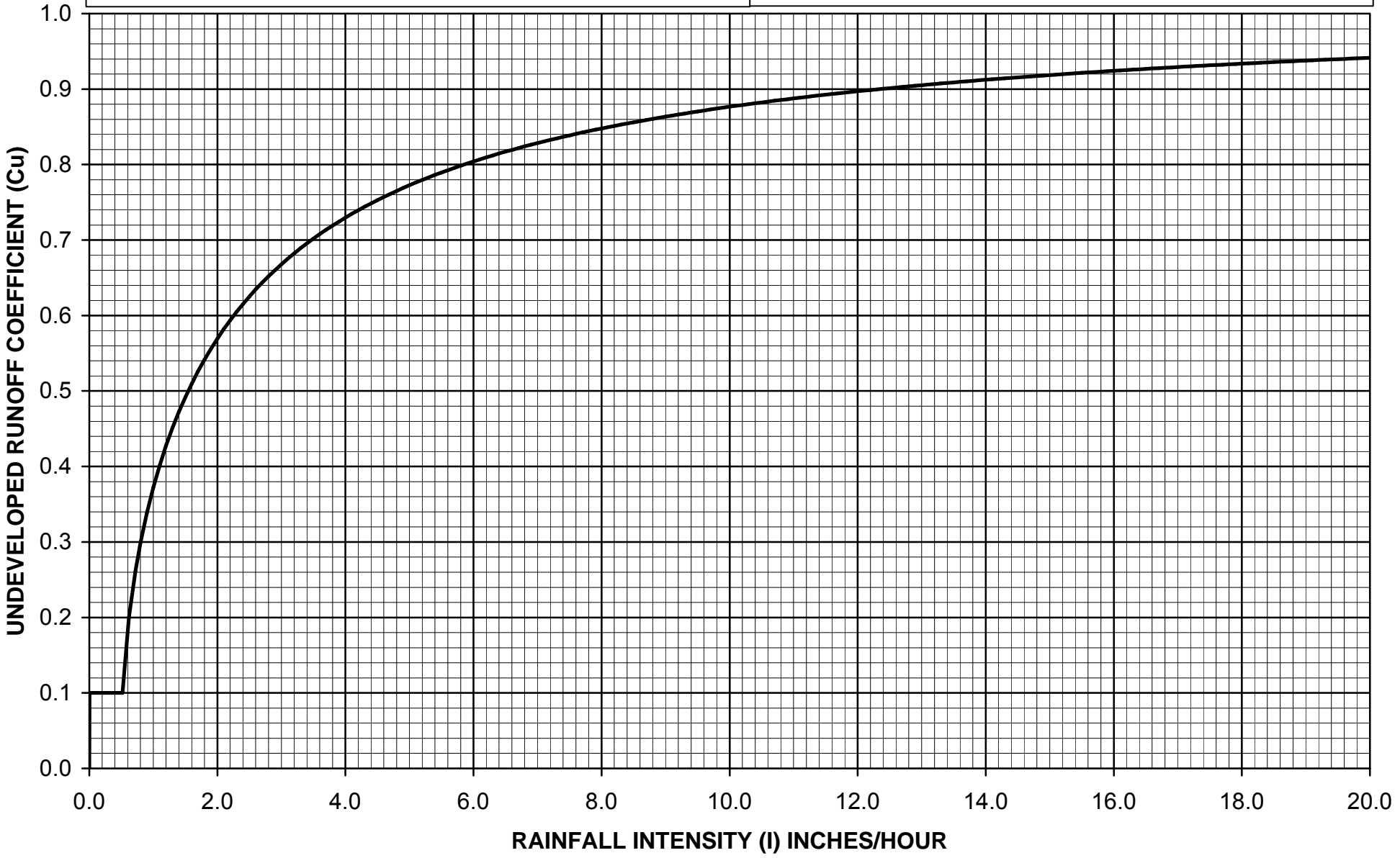

$C_D = (0.9 * IMP) + (1.0 - IMP) * C_U$
 Where: C_D = Developed Runoff Coefficient
 IMP = Proportion Impervious
 C_U = Undeveloped runoff coefficient



Los Angeles County Department of Public Works

RUNOFF COEFFICIENT CURVE
SOIL TYPE NO. 059

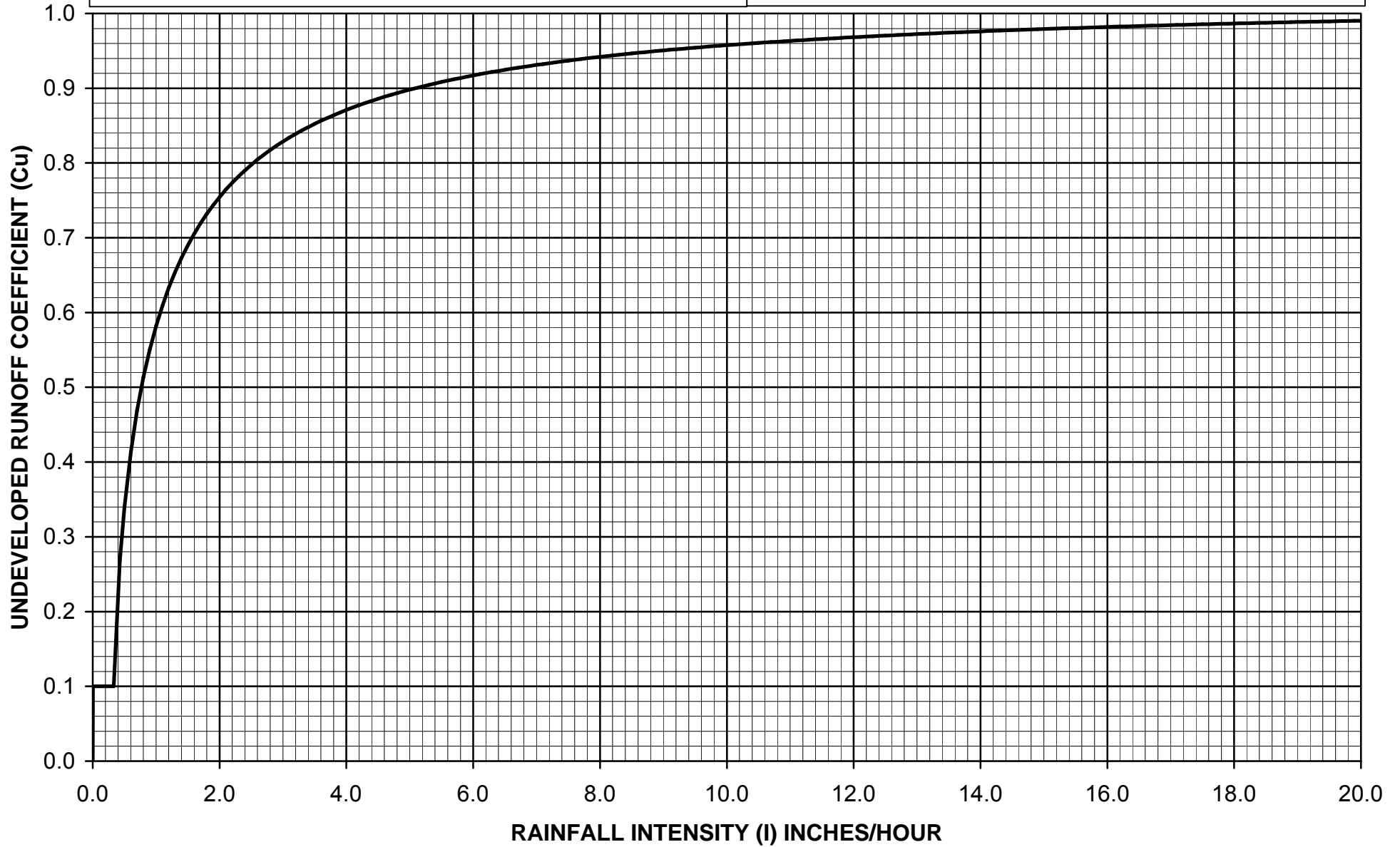

$C_D = (0.9 * IMP) + (1.0 - IMP) * C_U$
 Where: C_D = Developed Runoff Coefficient
 IMP = Proportion Impervious
 C_U = Undeveloped runoff coefficient



Los Angeles County Department of Public Works

RUNOFF COEFFICIENT CURVE
SOIL TYPE NO. 060

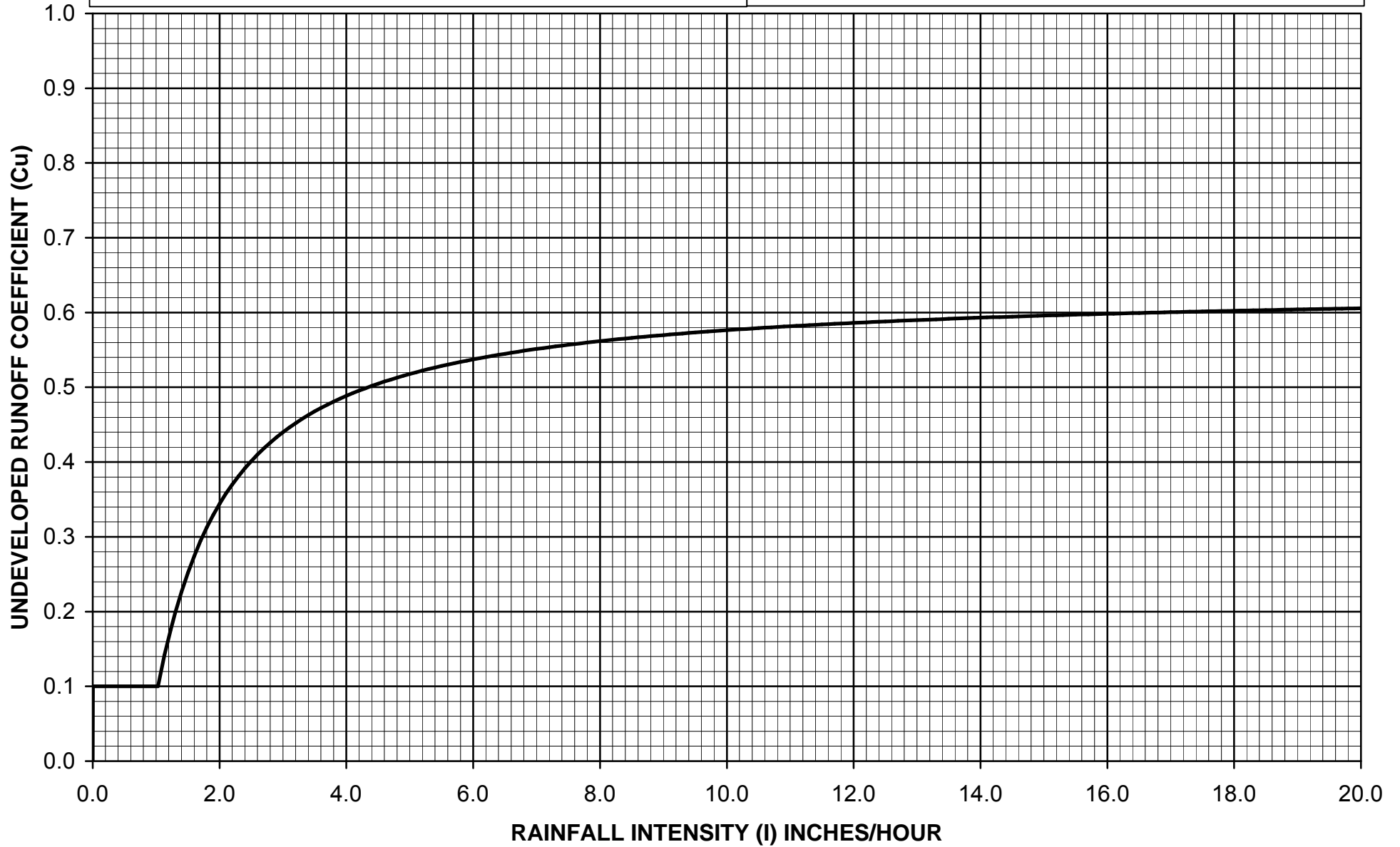

$C_D = (0.9 * IMP) + (1.0 - IMP) * C_U$
 Where: C_D = Developed Runoff Coefficient
 IMP = Proportion Impervious
 C_U = Undeveloped runoff coefficient



Los Angeles County Department of Public Works

RUNOFF COEFFICIENT CURVE
SOIL TYPE NO. 061

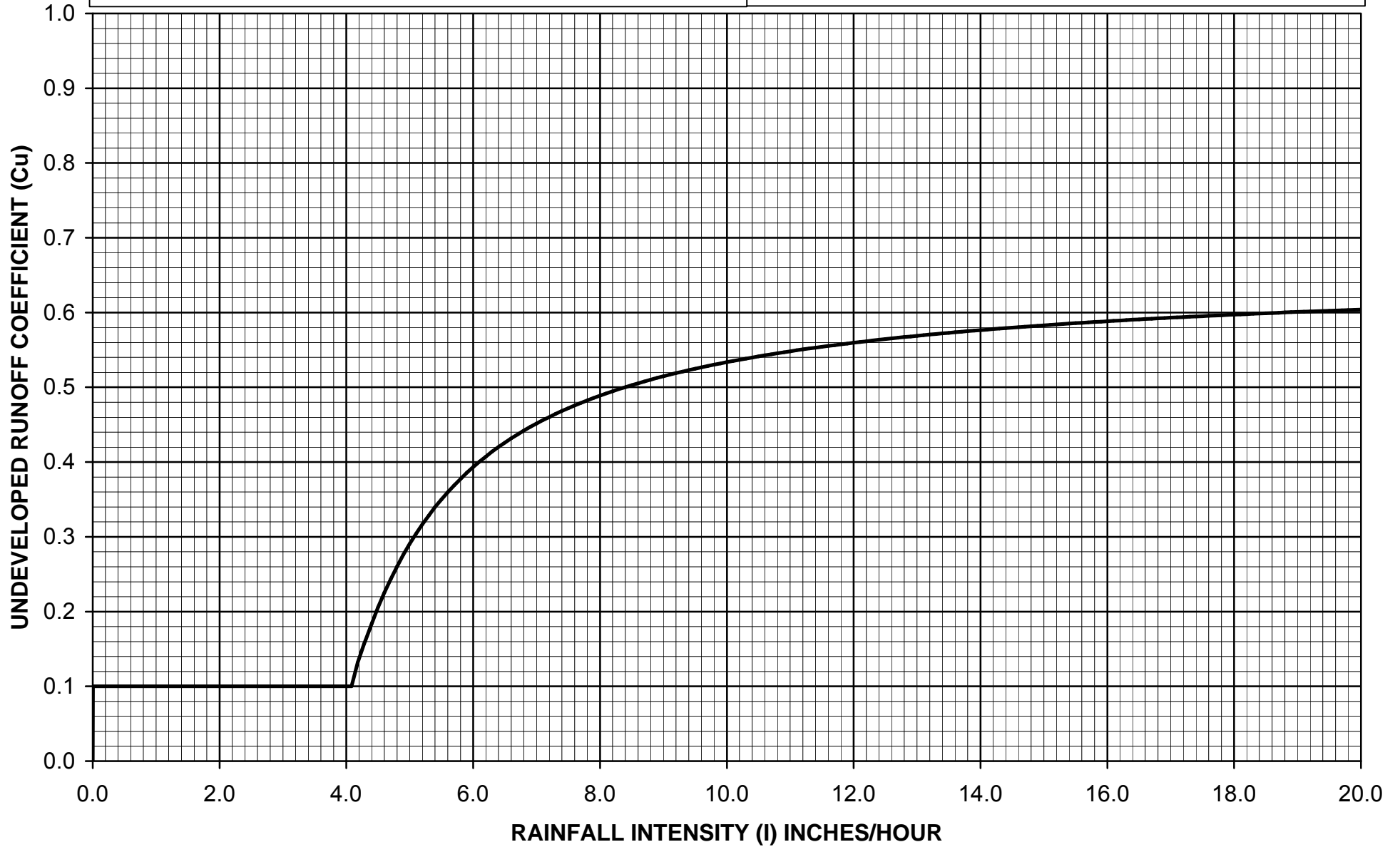

$C_D = (0.9 * IMP) + (1.0 - IMP) * C_U$
 Where: C_D = Developed Runoff Coefficient
 IMP = Proportion Impervious
 C_U = Undeveloped runoff coefficient



Los Angeles County Department of Public Works

RUNOFF COEFFICIENT CURVE
SOIL TYPE NO. 062

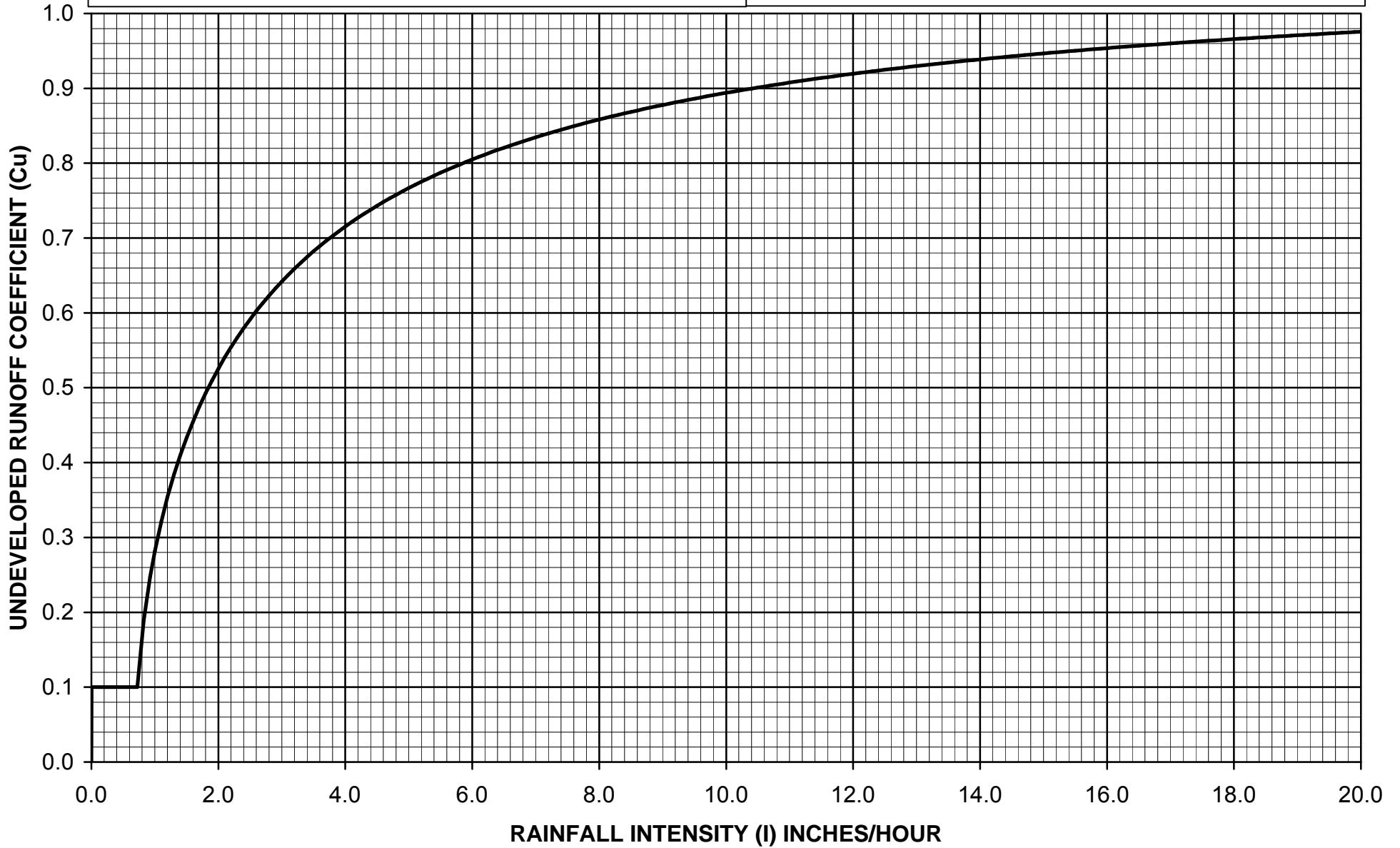

$C_D = (0.9 * IMP) + (1.0 - IMP) * C_U$
 Where: C_D = Developed Runoff Coefficient
 IMP = Proportion Impervious
 C_U = Undeveloped runoff coefficient



Los Angeles County Department of Public Works

RUNOFF COEFFICIENT CURVE
SOIL TYPE NO. 063

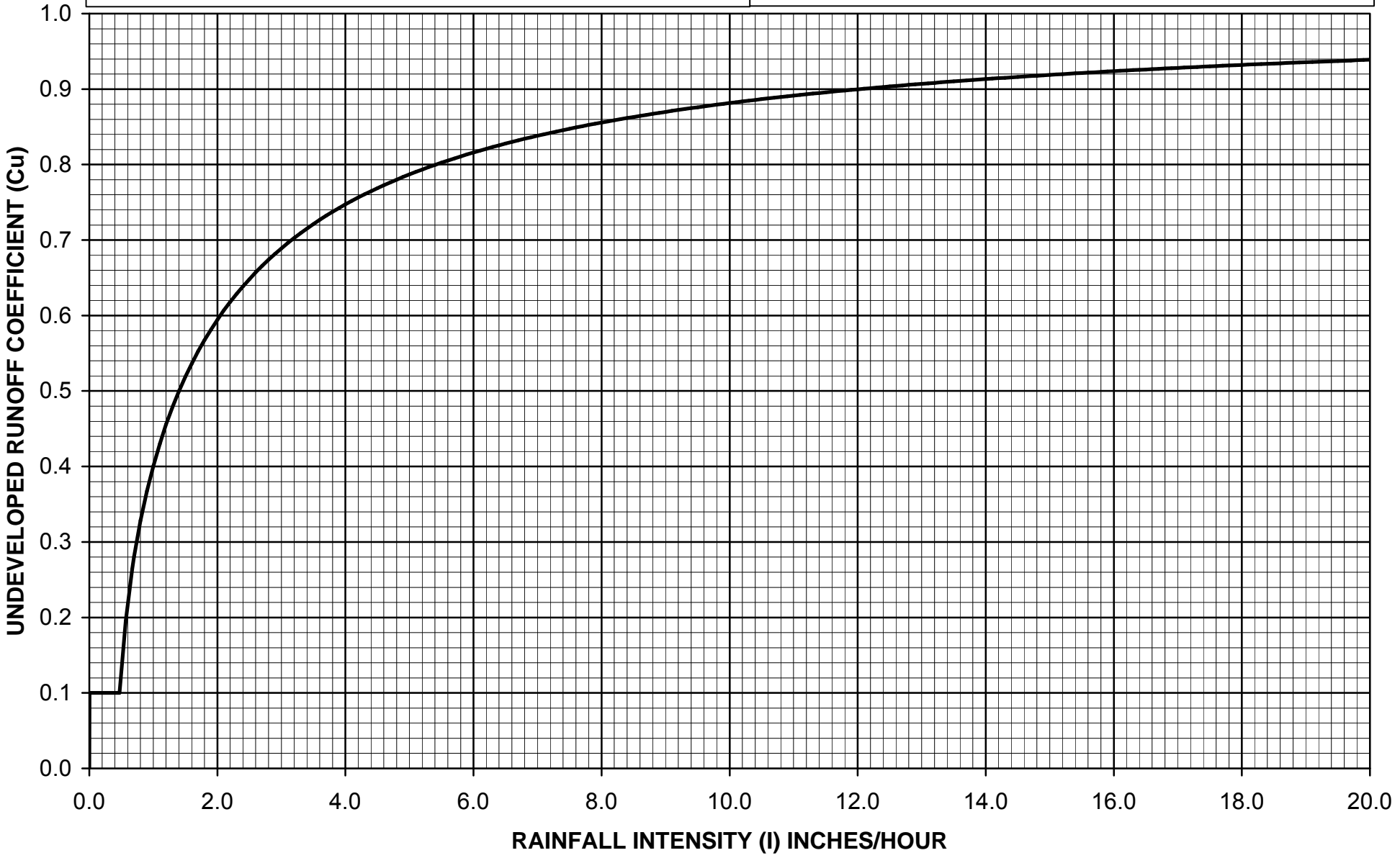

$C_D = (0.9 * IMP) + (1.0 - IMP) * C_U$
 Where: C_D = Developed Runoff Coefficient
 IMP = Proportion Impervious
 C_U = Undeveloped runoff coefficient



Los Angeles County Department of Public Works

RUNOFF COEFFICIENT CURVE
SOIL TYPE NO. 064

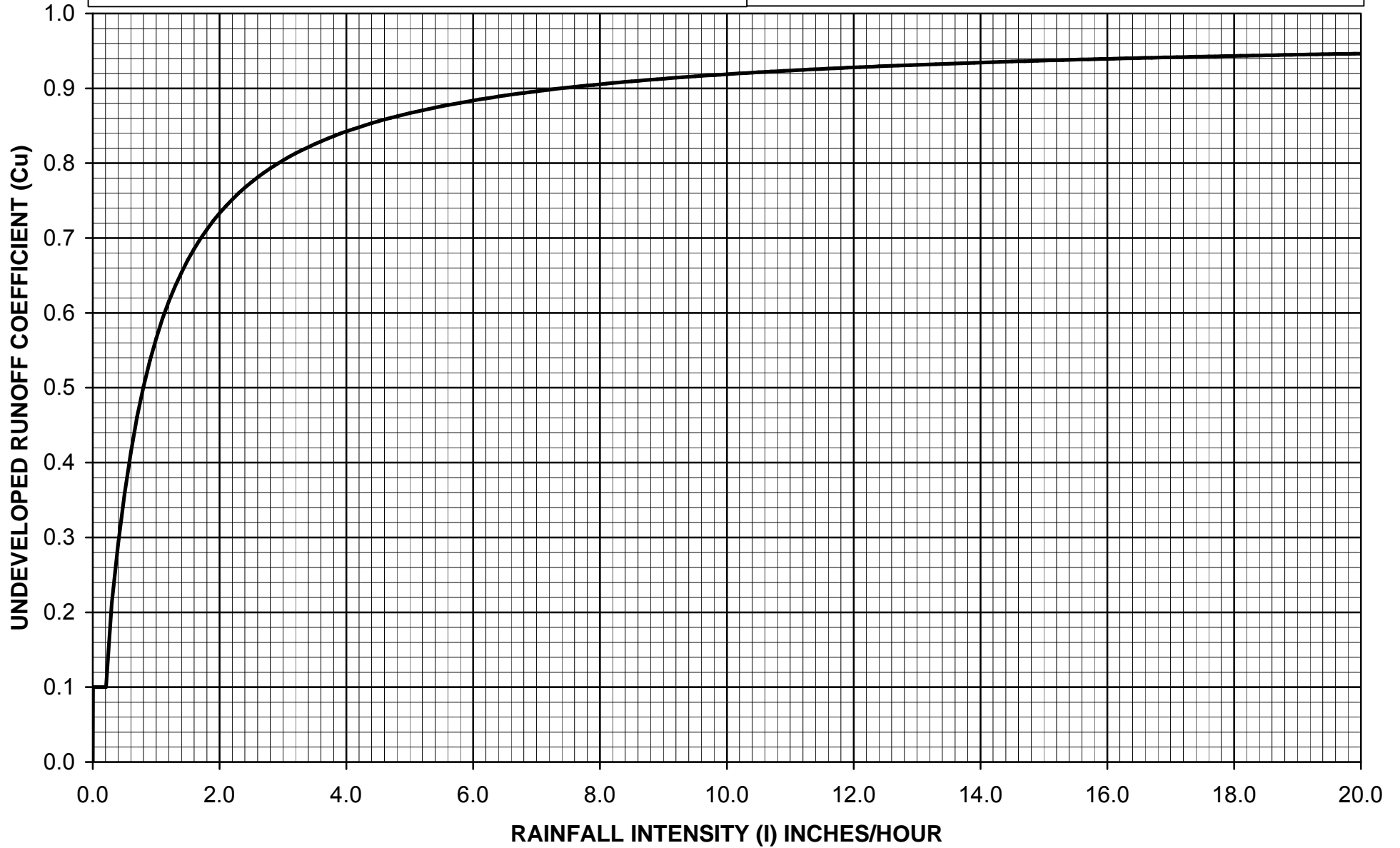

$C_D = (0.9 * IMP) + (1.0 - IMP) * C_U$
 Where: C_D = Developed Runoff Coefficient
 IMP = Proportion Impervious
 C_U = Undeveloped runoff coefficient



Los Angeles County Department of Public Works

RUNOFF COEFFICIENT CURVE
SOIL TYPE NO. 065

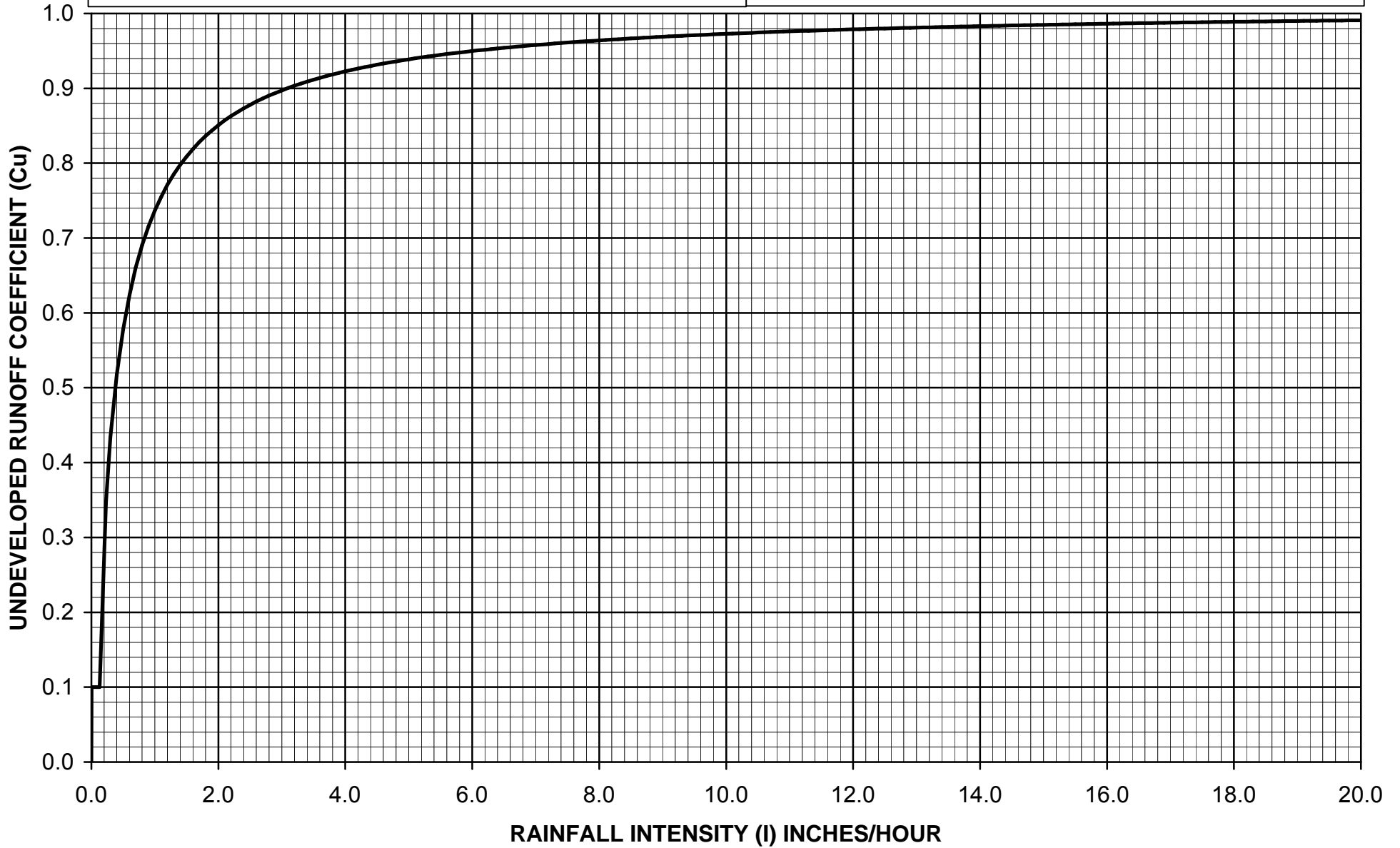

$C_D = (0.9 * IMP) + (1.0 - IMP) * C_U$
 Where: C_D = Developed Runoff Coefficient
 IMP = Proportion Impervious
 C_U = Undeveloped runoff coefficient



Los Angeles County Department of Public Works

RUNOFF COEFFICIENT CURVE
SOIL TYPE NO. 066

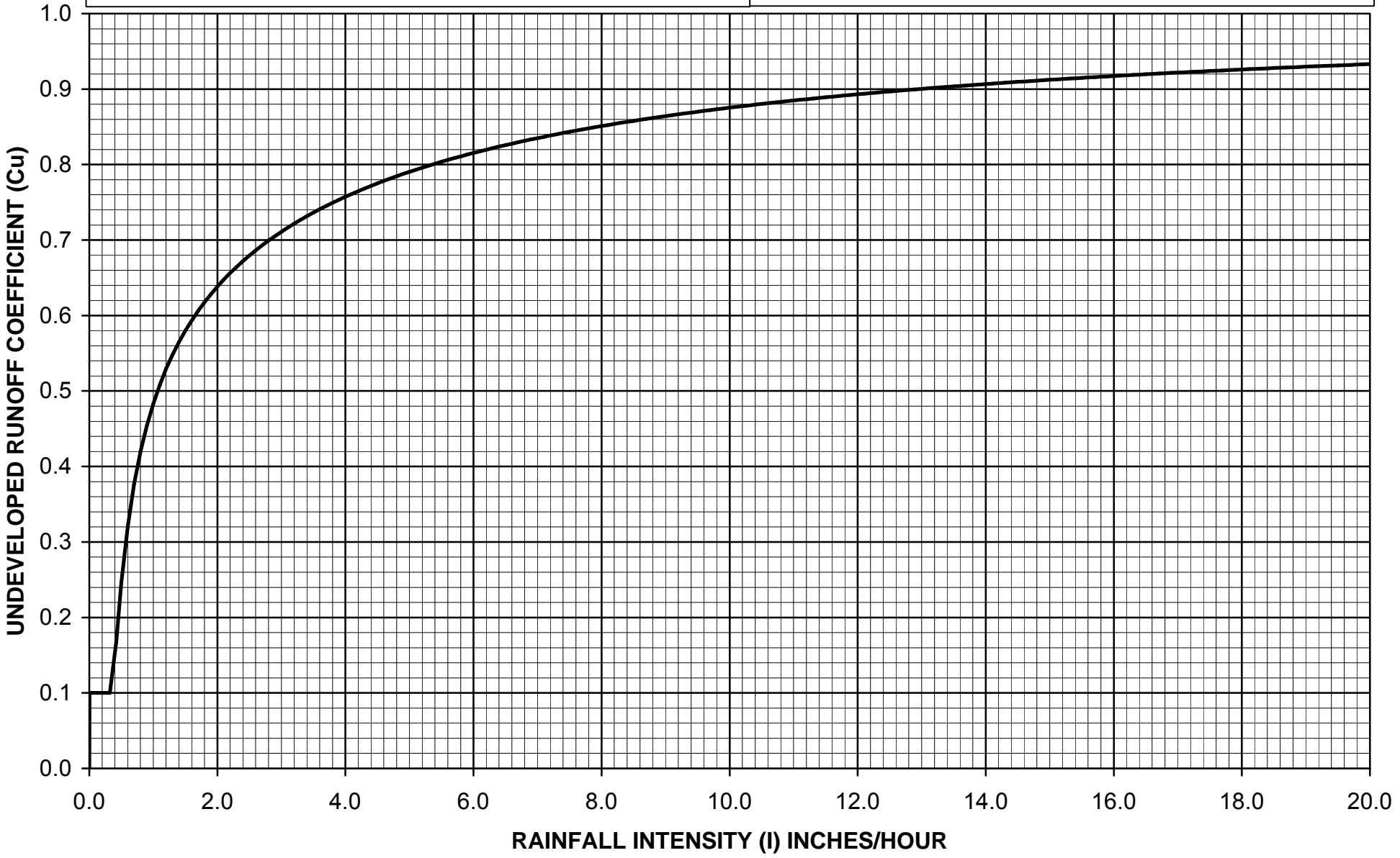

$C_D = (0.9 * IMP) + (1.0 - IMP) * C_U$
 Where: C_D = Developed Runoff Coefficient
 IMP = Proportion Impervious
 C_U = Undeveloped runoff coefficient



Los Angeles County Department of Public Works

RUNOFF COEFFICIENT CURVE
SOIL TYPE NO. 067

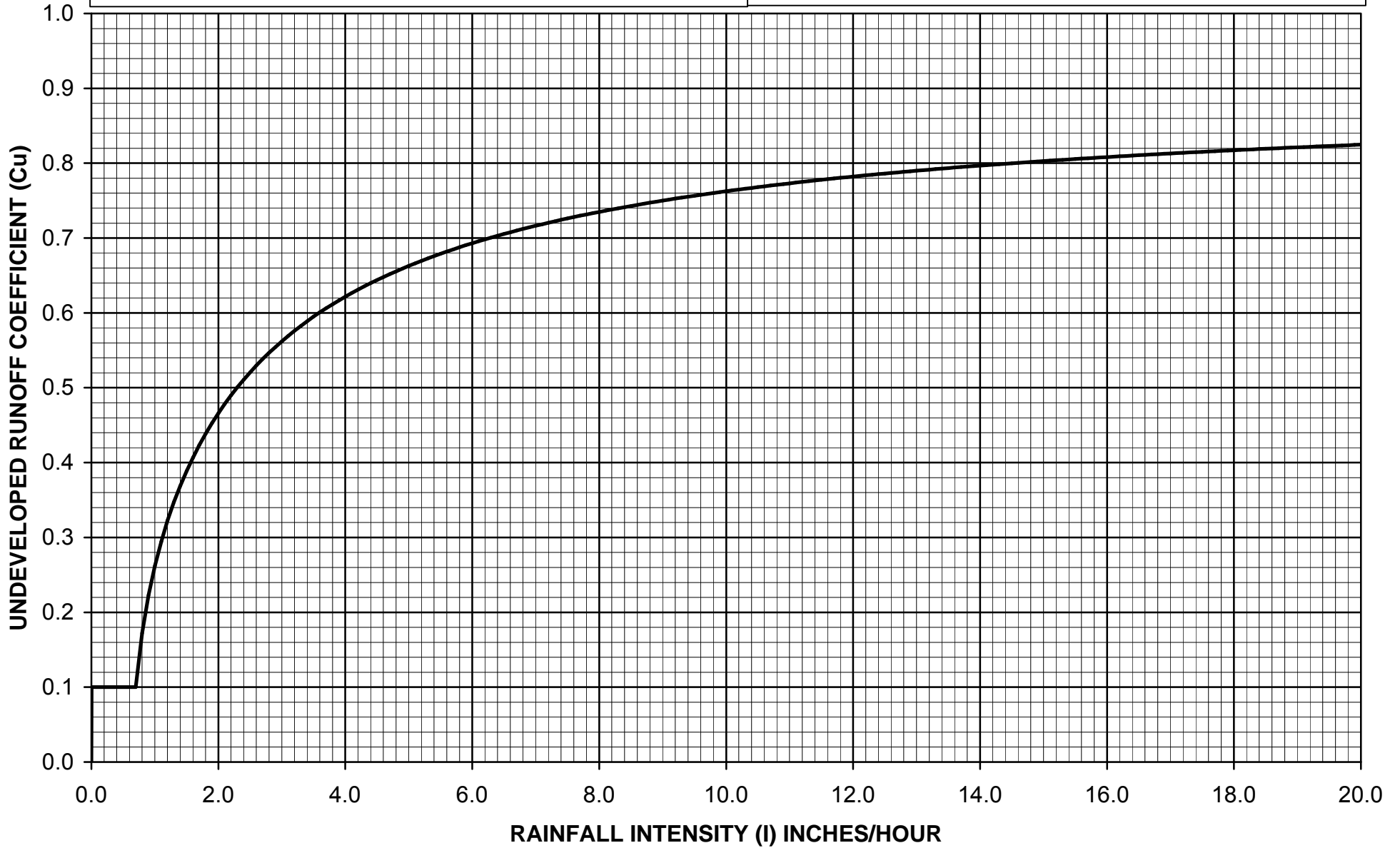

$C_D = (0.9 * IMP) + (1.0 - IMP) * C_U$
 Where: C_D = Developed Runoff Coefficient
 IMP = Proportion Impervious
 C_U = Undeveloped runoff coefficient



Los Angeles County Department of Public Works

RUNOFF COEFFICIENT CURVE
SOIL TYPE NO. 068

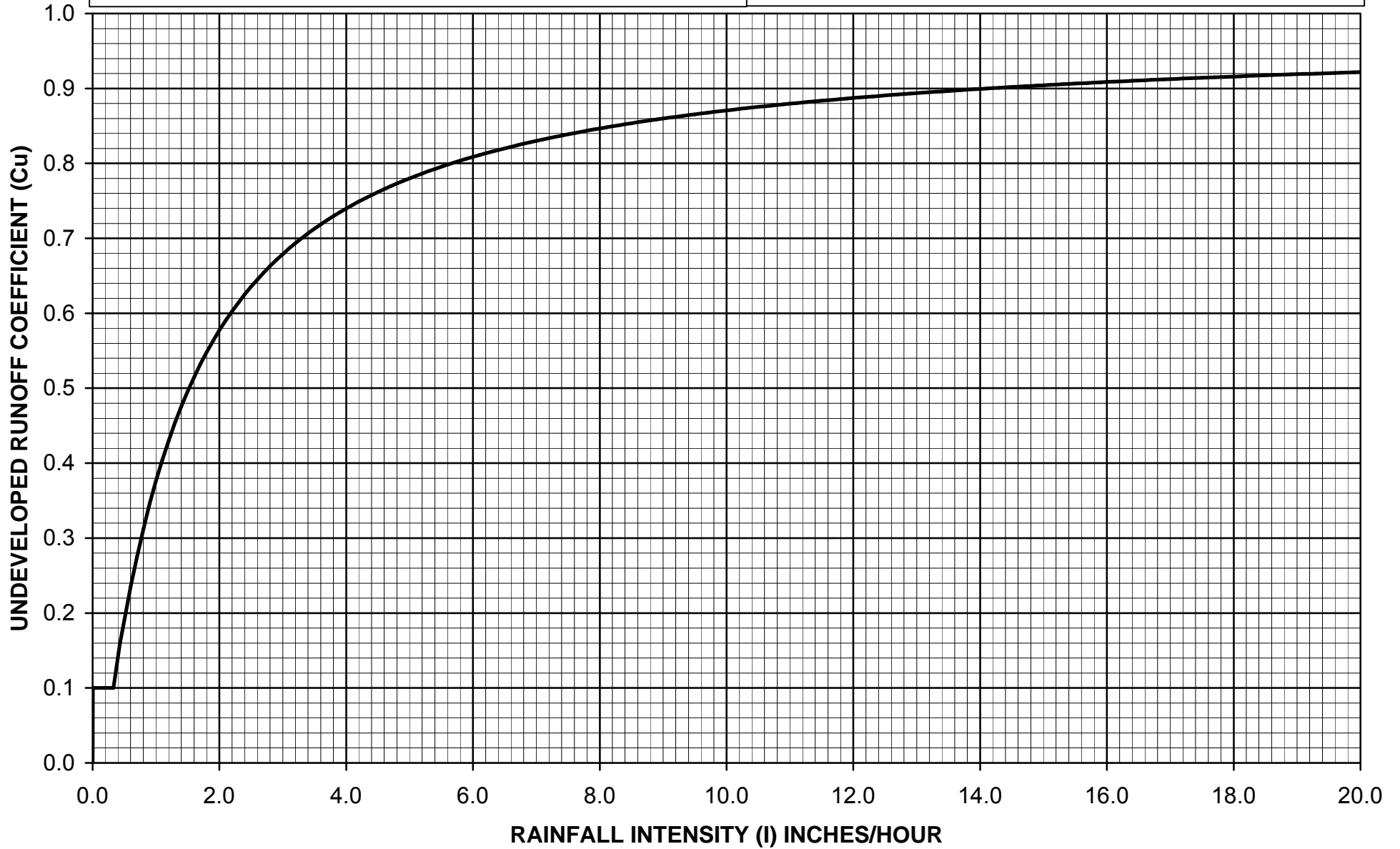

$C_D = (0.9 * IMP) + (1.0 - IMP) * C_U$
 Where: C_D = Developed Runoff Coefficient
 IMP = Proportion Impervious
 C_U = Undeveloped runoff coefficient



Los Angeles County Department of Public Works

RUNOFF COEFFICIENT CURVE
SOIL TYPE NO. 069

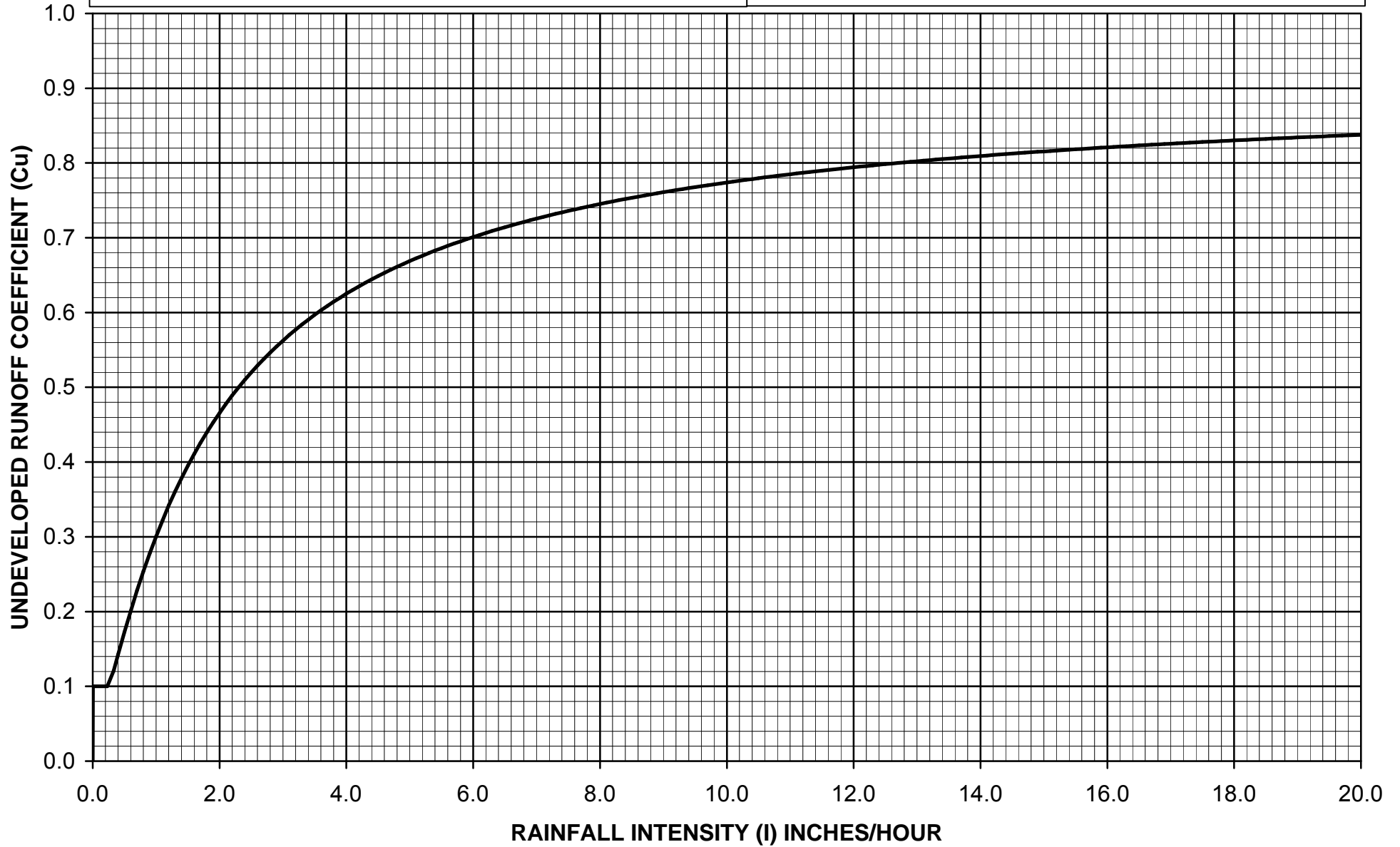

$C_D = (0.9 * IMP) + (1.0 - IMP) * C_U$
 Where: C_D = Developed Runoff Coefficient
 IMP = Proportion Impervious
 C_U = Undeveloped runoff coefficient



Los Angeles County Department of Public Works

RUNOFF COEFFICIENT CURVE
SOIL TYPE NO. 070

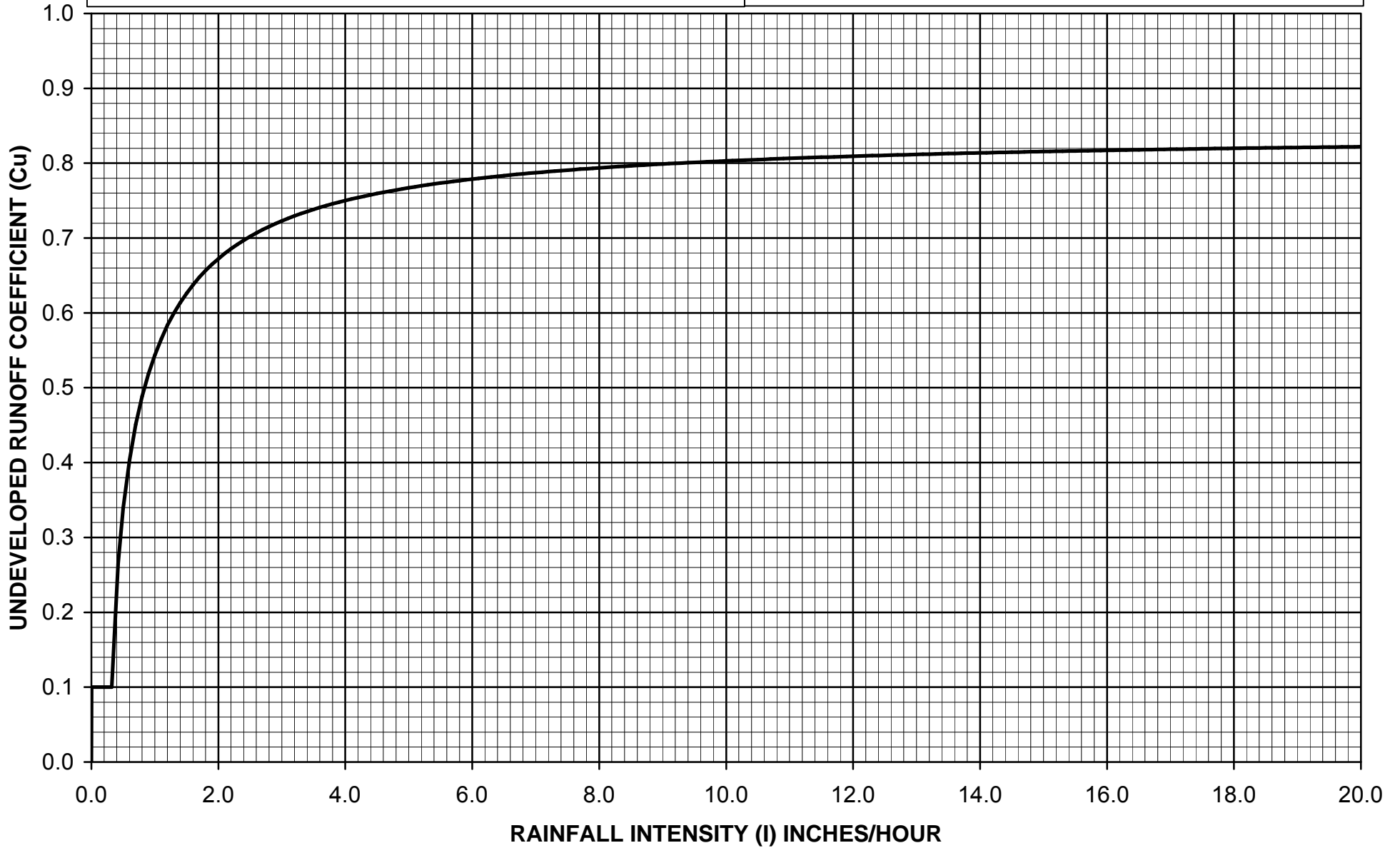

$C_D = (0.9 * IMP) + (1.0 - IMP) * C_U$
 Where: C_D = Developed Runoff Coefficient
 IMP = Proportion Impervious
 C_U = Undeveloped runoff coefficient



Los Angeles County Department of Public Works

RUNOFF COEFFICIENT CURVE
SOIL TYPE NO. 071

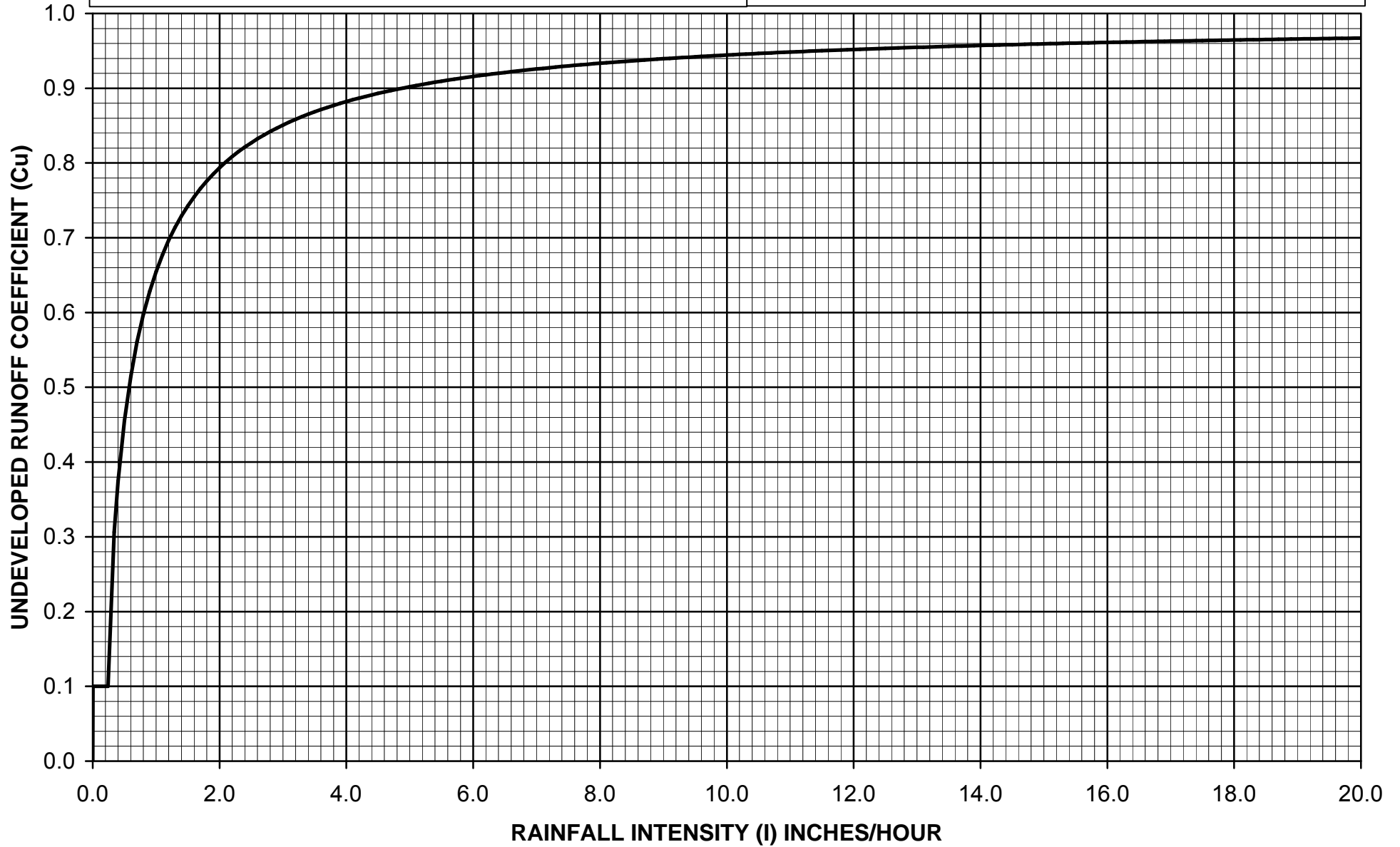

$C_D = (0.9 * IMP) + (1.0 - IMP) * C_U$
 Where: C_D = Developed Runoff Coefficient
 IMP = Proportion Impervious
 C_U = Undeveloped runoff coefficient



Los Angeles County Department of Public Works

RUNOFF COEFFICIENT CURVE
SOIL TYPE NO. 072

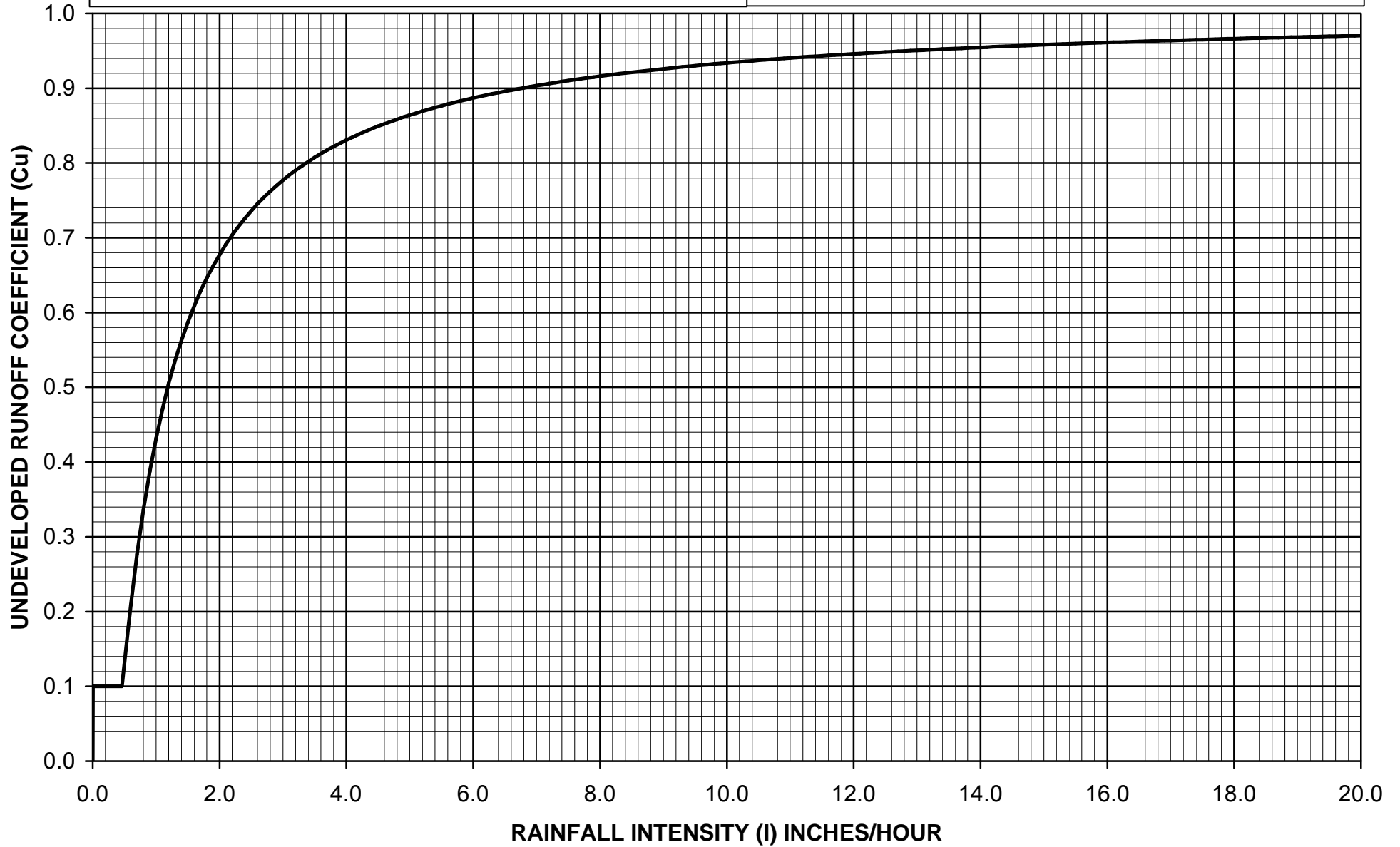

$C_D = (0.9 * IMP) + (1.0 - IMP) * C_U$
 Where: C_D = Developed Runoff Coefficient
 IMP = Proportion Impervious
 C_U = Undeveloped runoff coefficient



Los Angeles County Department of Public Works

RUNOFF COEFFICIENT CURVE
SOIL TYPE NO. 073

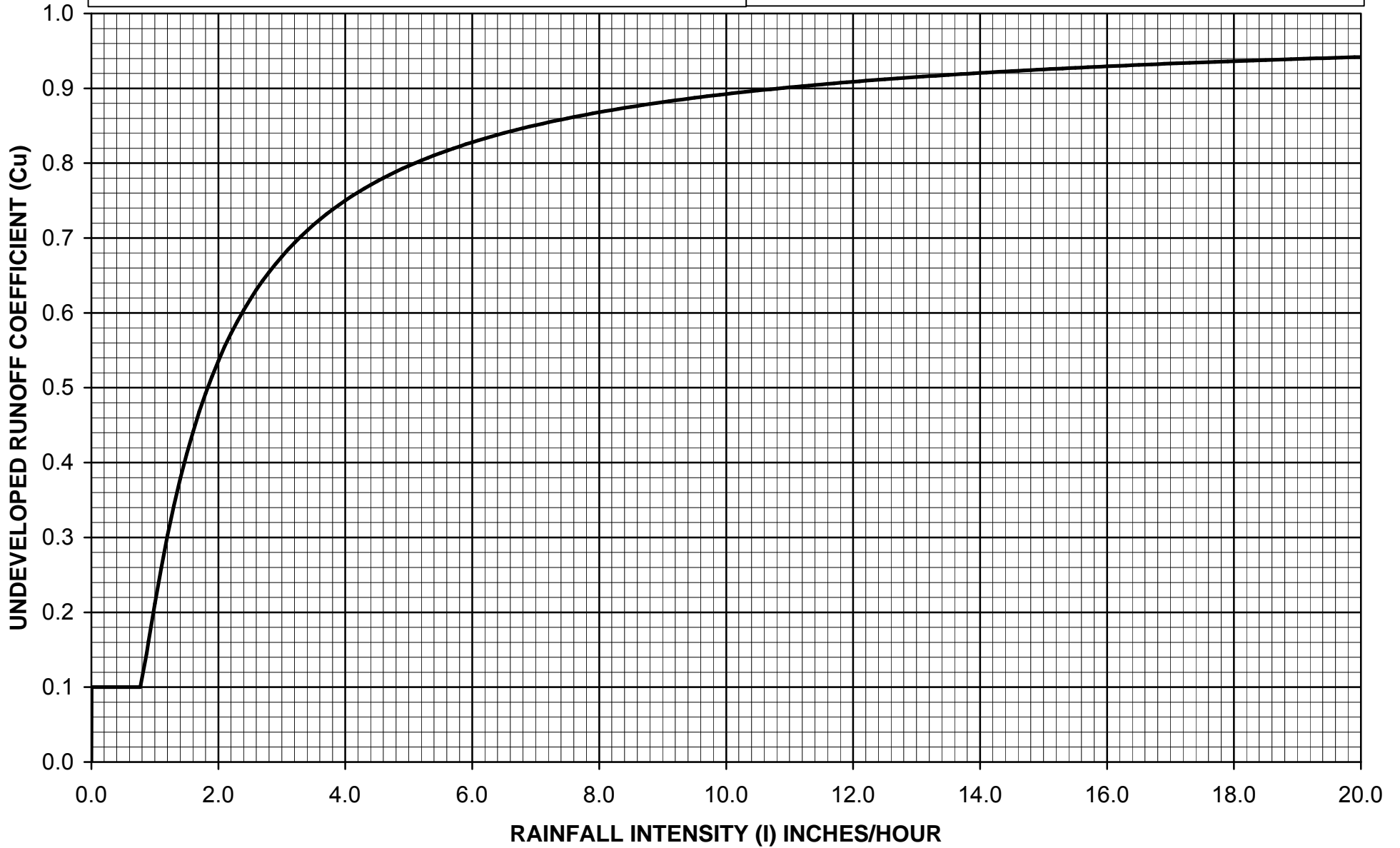

$C_D = (0.9 * IMP) + (1.0 - IMP) * C_U$
 Where: C_D = Developed Runoff Coefficient
 IMP = Proportion Impervious
 C_U = Undeveloped runoff coefficient



Los Angeles County Department of Public Works

RUNOFF COEFFICIENT CURVE
SOIL TYPE NO. 074

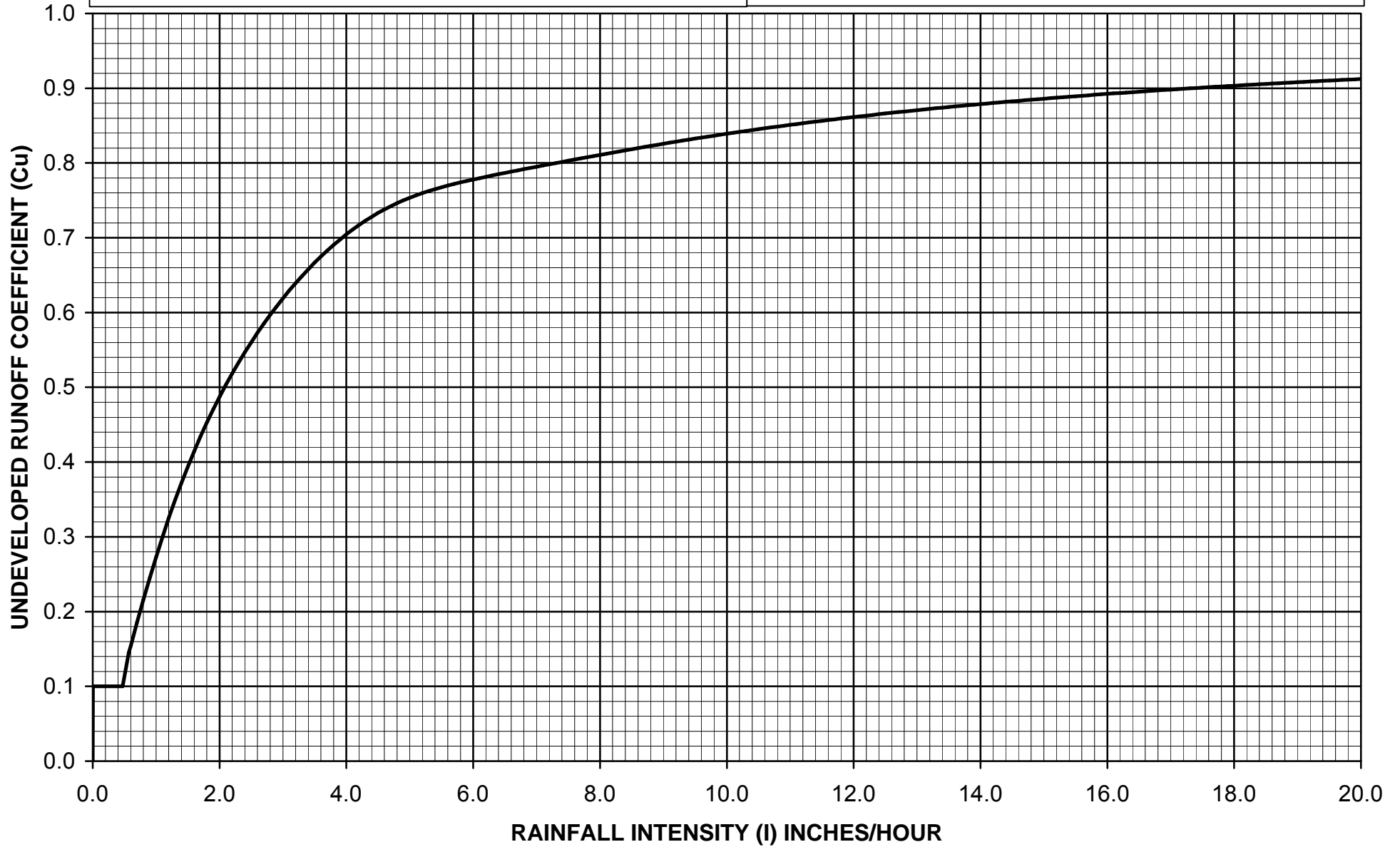

$C_D = (0.9 * IMP) + (1.0 - IMP) * C_U$
 Where: C_D = Developed Runoff Coefficient
 IMP = Proportion Impervious
 C_U = Undeveloped runoff coefficient



Los Angeles County Department of Public Works

RUNOFF COEFFICIENT CURVE
SOIL TYPE NO. 075

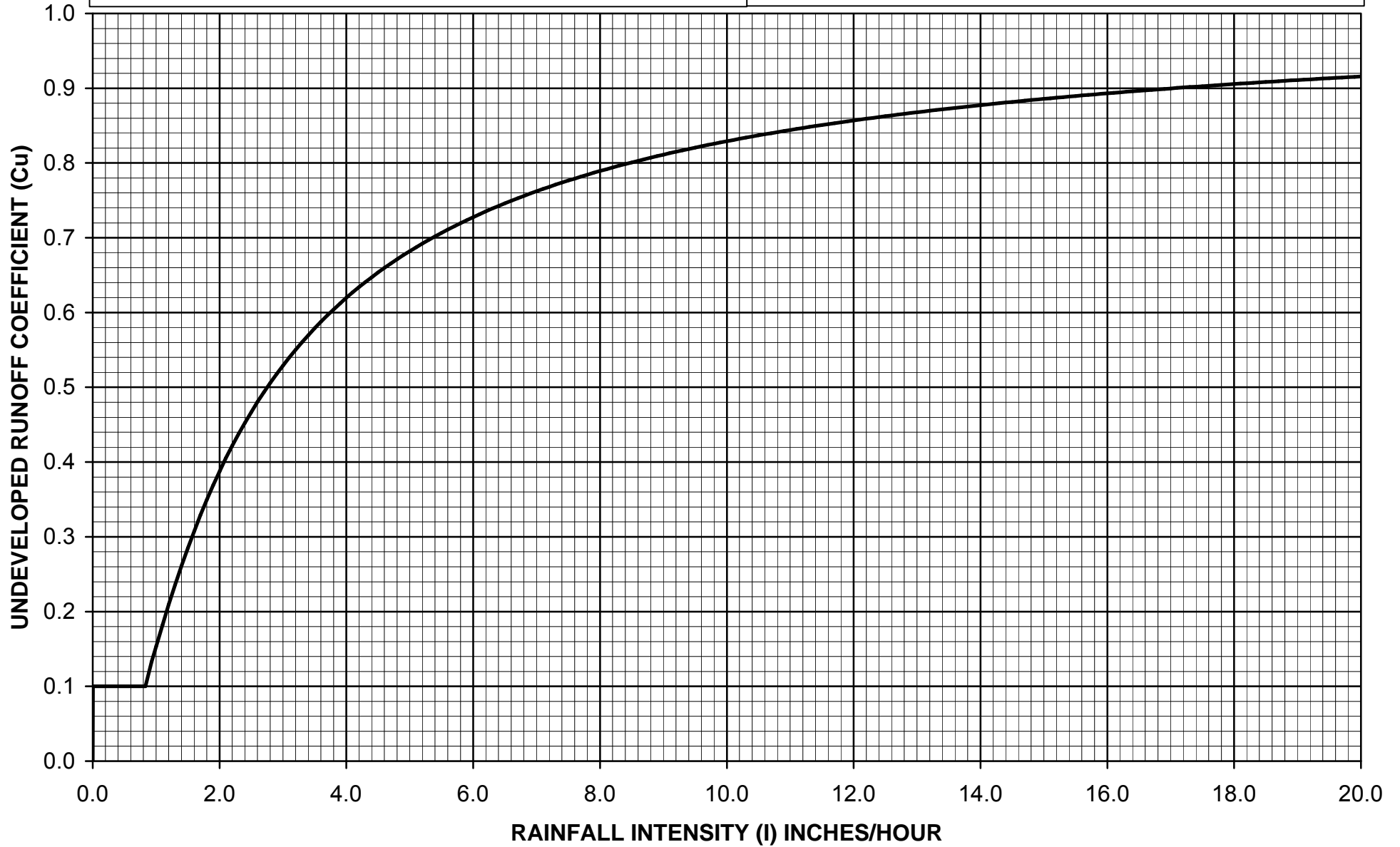

$C_D = (0.9 * IMP) + (1.0 - IMP) * C_U$
 Where: C_D = Developed Runoff Coefficient
 IMP = Proportion Impervious
 C_U = Undeveloped runoff coefficient



Los Angeles County Department of Public Works

RUNOFF COEFFICIENT CURVE
SOIL TYPE NO. 076

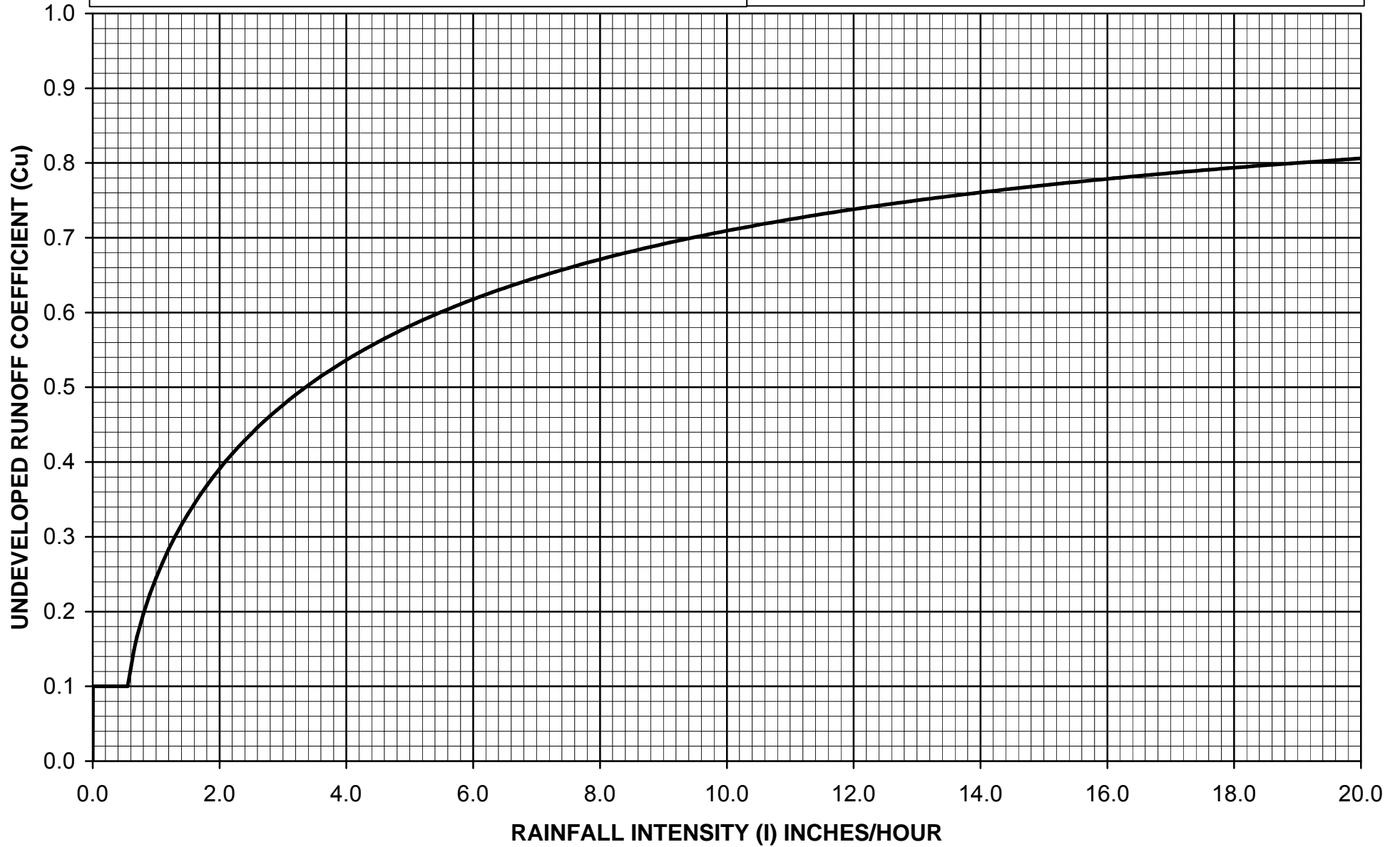

$$C_D = (0.9 * IMP) + (1.0 - IMP) * C_U$$

Where: C_D = Developed Runoff Coefficient

IMP = Proportion Impervious

C_U = Undeveloped runoff coefficient



Los Angeles County Department of Public Works

RUNOFF COEFFICIENT CURVE
SOIL TYPE NO. 077

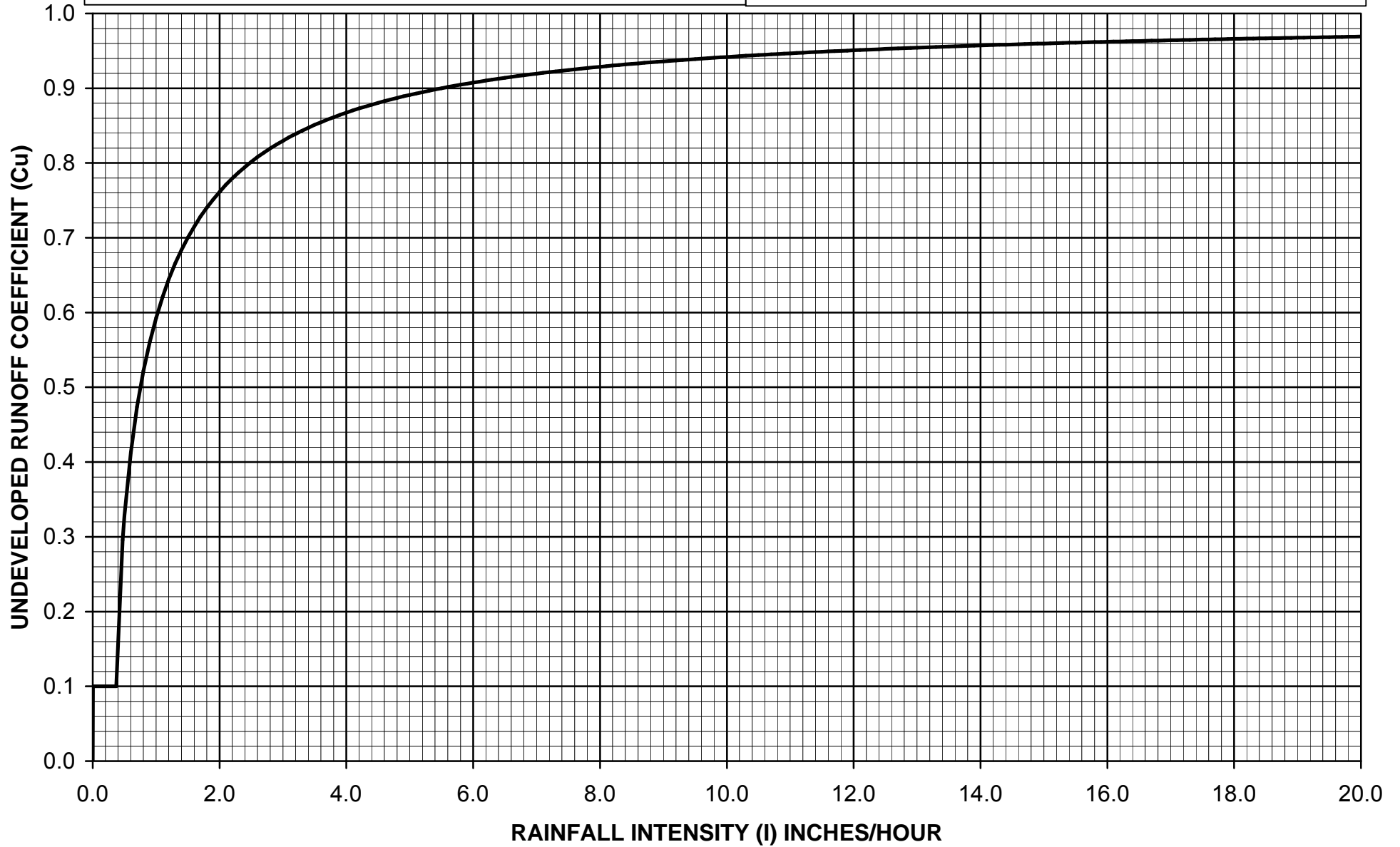

$C_D = (0.9 * IMP) + (1.0 - IMP) * C_U$
 Where: C_D = Developed Runoff Coefficient
 IMP = Proportion Impervious
 C_U = Undeveloped runoff coefficient



Los Angeles County Department of Public Works

RUNOFF COEFFICIENT CURVE
SOIL TYPE NO. 078

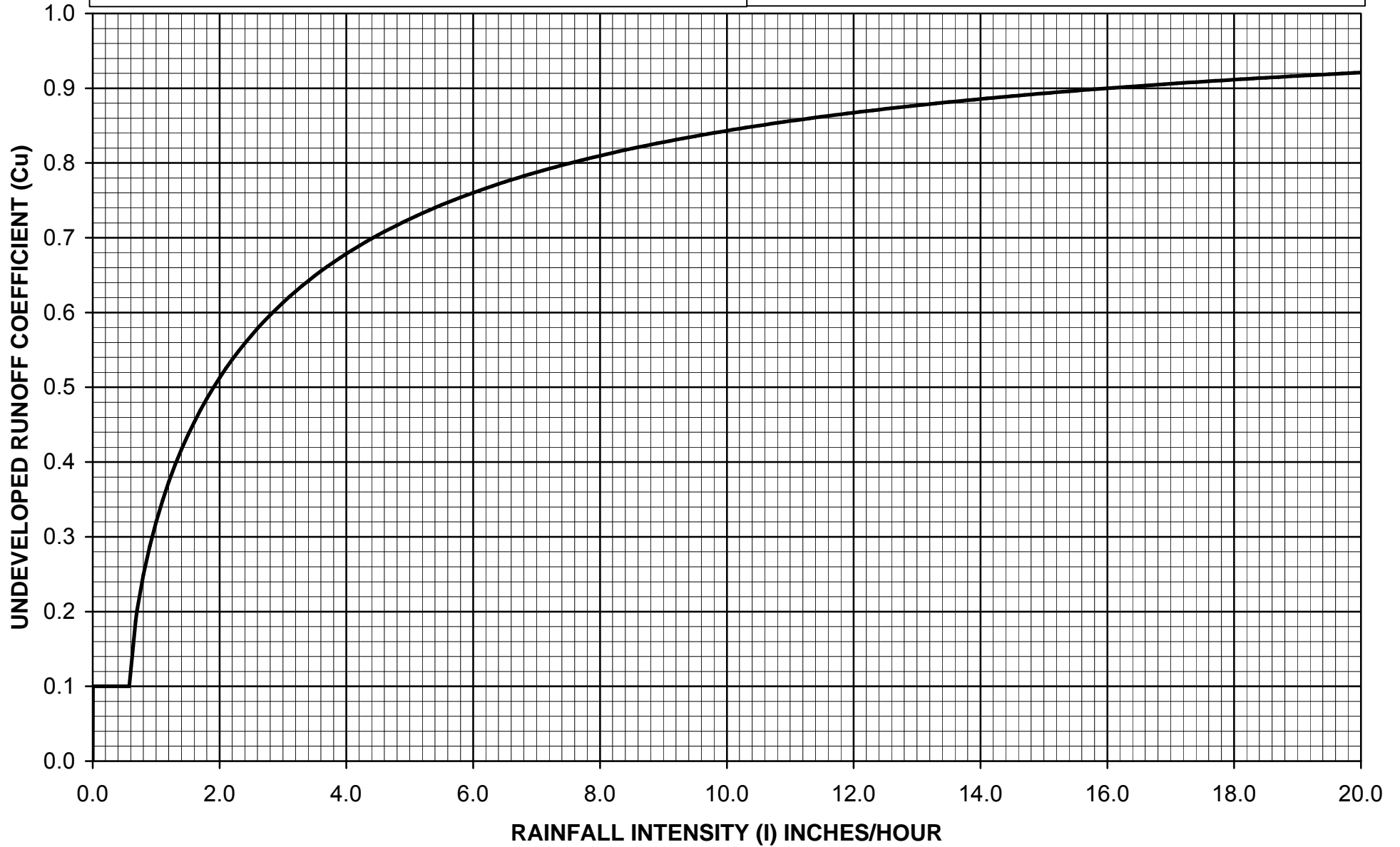

$C_D = (0.9 * IMP) + (1.0 - IMP) * C_U$
 Where: C_D = Developed Runoff Coefficient
 IMP = Proportion Impervious
 C_U = Undeveloped runoff coefficient



Los Angeles County Department of Public Works

RUNOFF COEFFICIENT CURVE
SOIL TYPE NO. 079

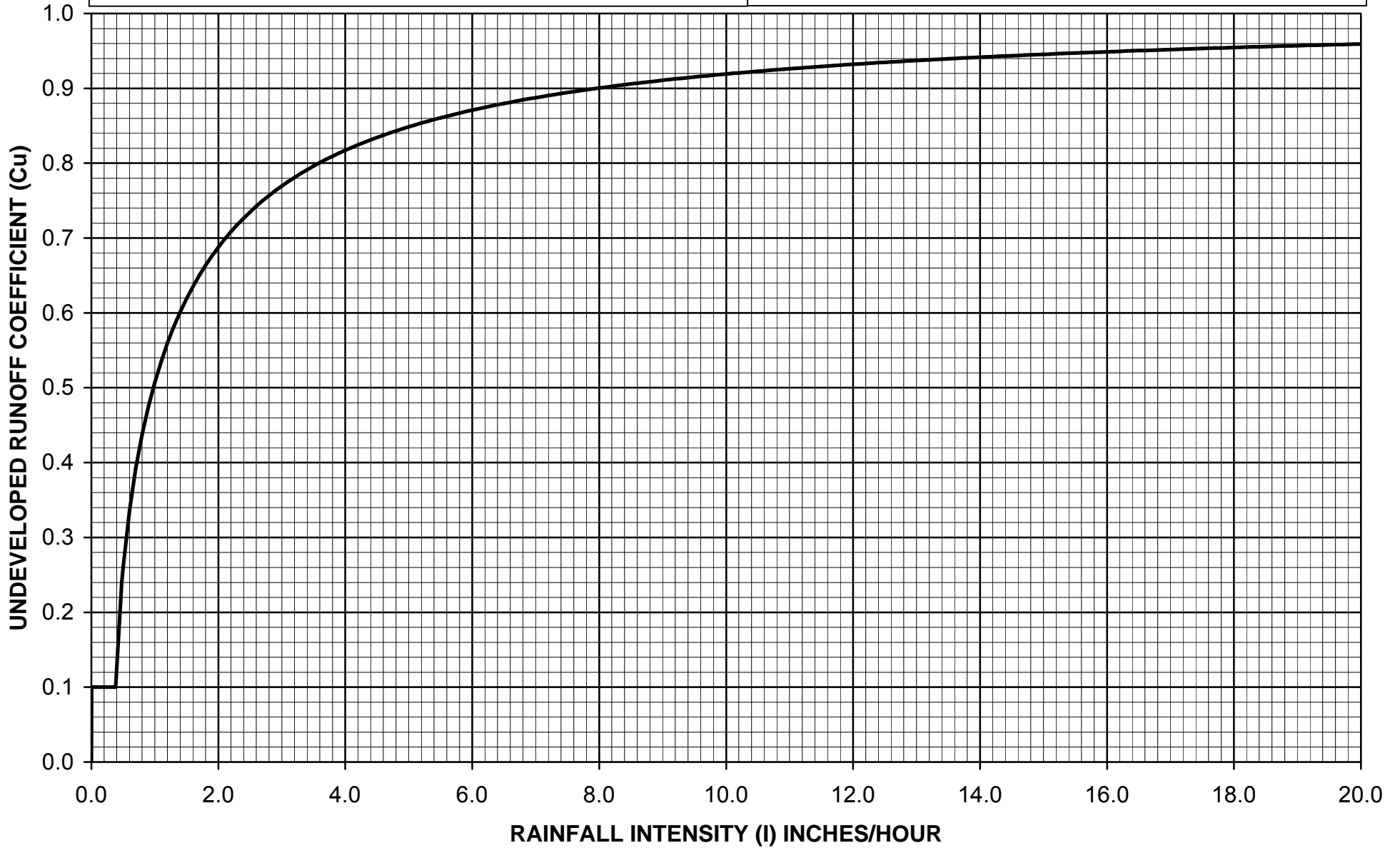

$C_D = (0.9 * IMP) + (1.0 - IMP) * C_U$
 Where: C_D = Developed Runoff Coefficient
 IMP = Proportion Impervious
 C_U = Undeveloped runoff coefficient



Los Angeles County Department of Public Works

RUNOFF COEFFICIENT CURVE
SOIL TYPE NO. 080

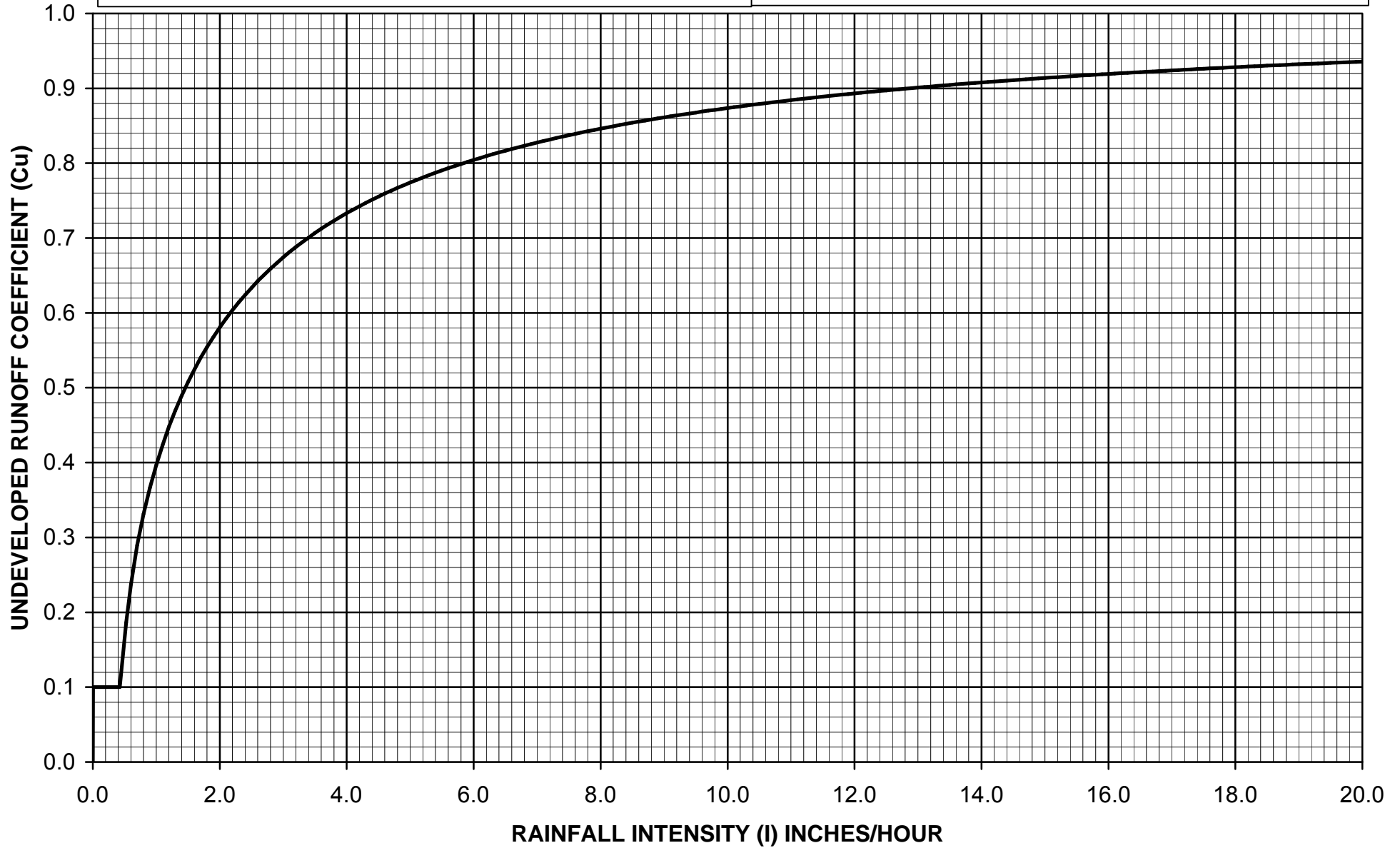

$C_D = (0.9 * IMP) + (1.0 - IMP) * C_U$
 Where: C_D = Developed Runoff Coefficient
 IMP = Proportion Impervious
 C_U = Undeveloped runoff coefficient



Los Angeles County Department of Public Works

RUNOFF COEFFICIENT CURVE
SOIL TYPE NO. 081

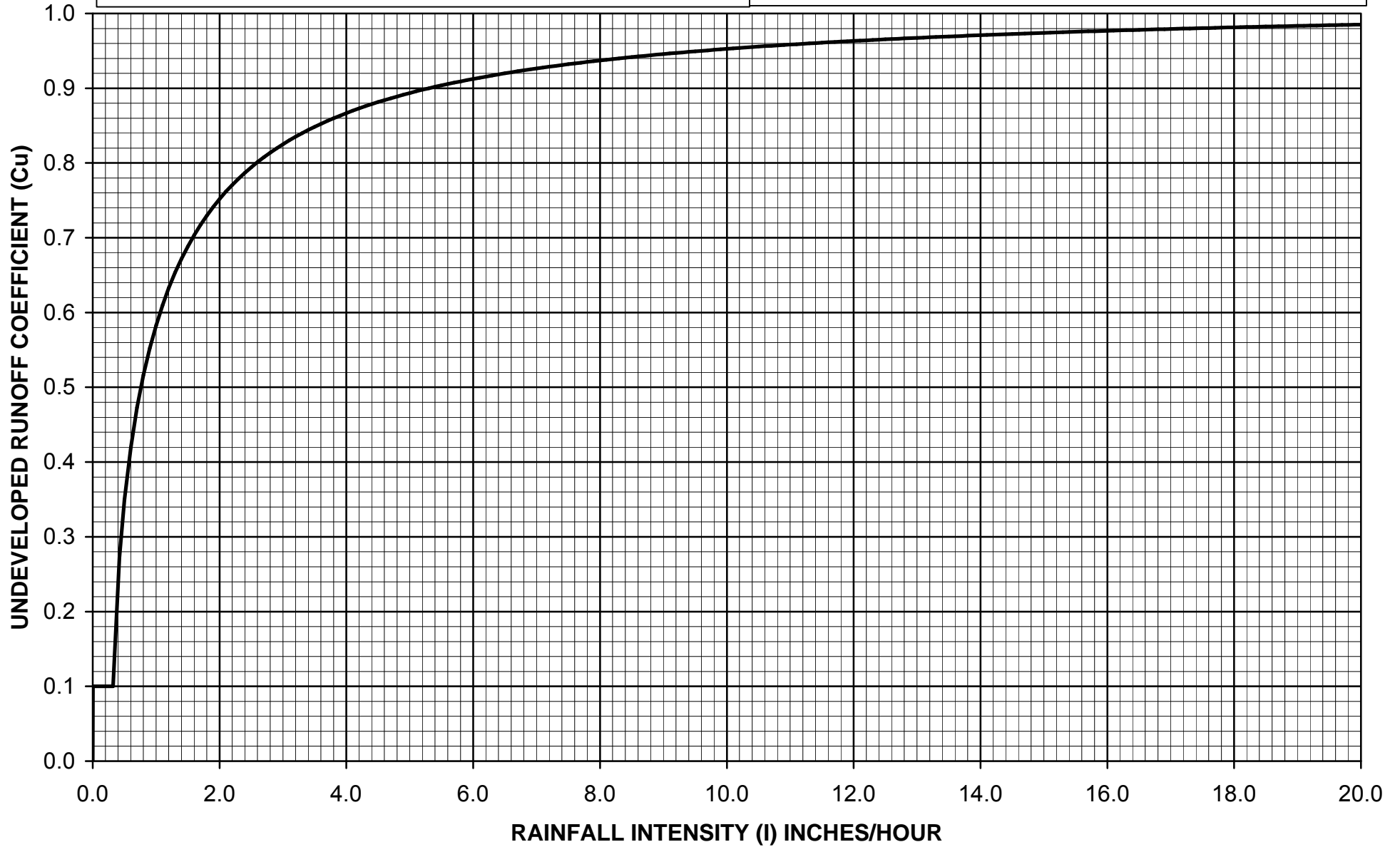

$C_D = (0.9 * IMP) + (1.0 - IMP) * C_U$
 Where: C_D = Developed Runoff Coefficient
 IMP = Proportion Impervious
 C_U = Undeveloped runoff coefficient



Los Angeles County Department of Public Works

RUNOFF COEFFICIENT CURVE
SOIL TYPE NO. 082

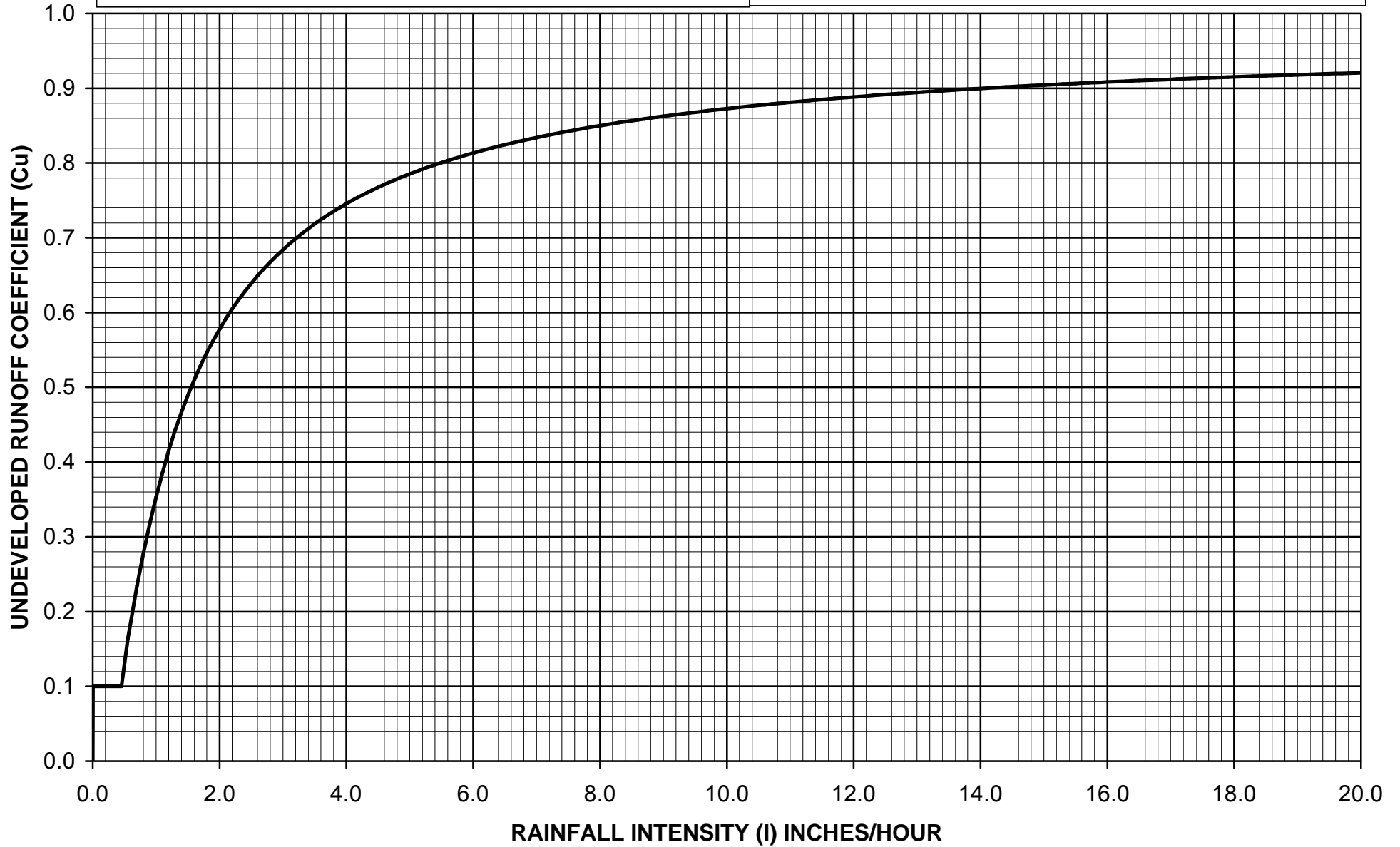

$$C_D = (0.9 * IMP) + (1.0 - IMP) * C_U$$

Where: C_D = Developed Runoff Coefficient
 IMP = Proportion Impervious
 C_U = Undeveloped runoff coefficient



Los Angeles County Department of Public Works

RUNOFF COEFFICIENT CURVE
SOIL TYPE NO. 083

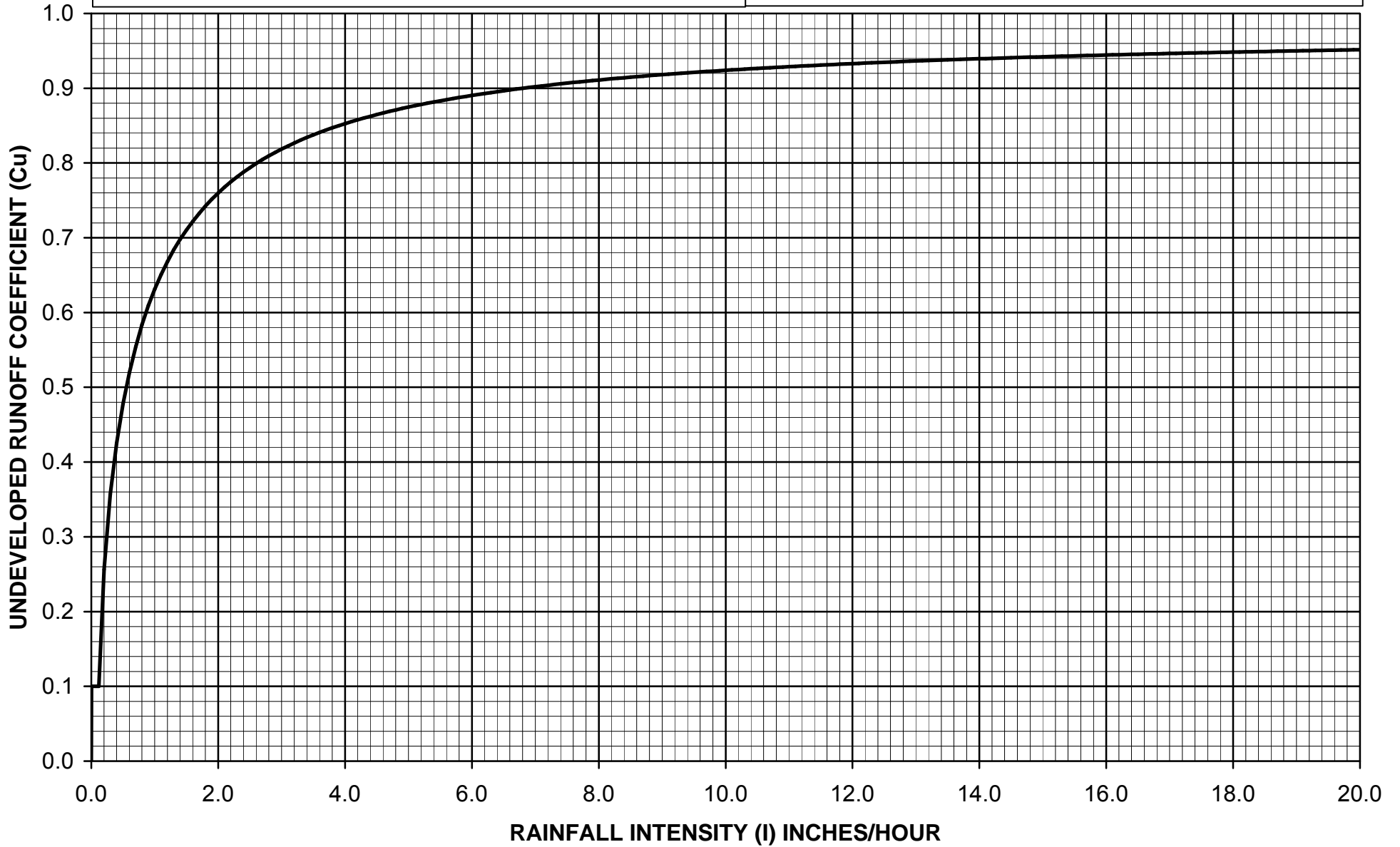

$C_D = (0.9 * IMP) + (1.0 - IMP) * C_U$
 Where: C_D = Developed Runoff Coefficient
 IMP = Proportion Impervious
 C_U = Undeveloped runoff coefficient



Los Angeles County Department of Public Works

RUNOFF COEFFICIENT CURVE
SOIL TYPE NO. 084

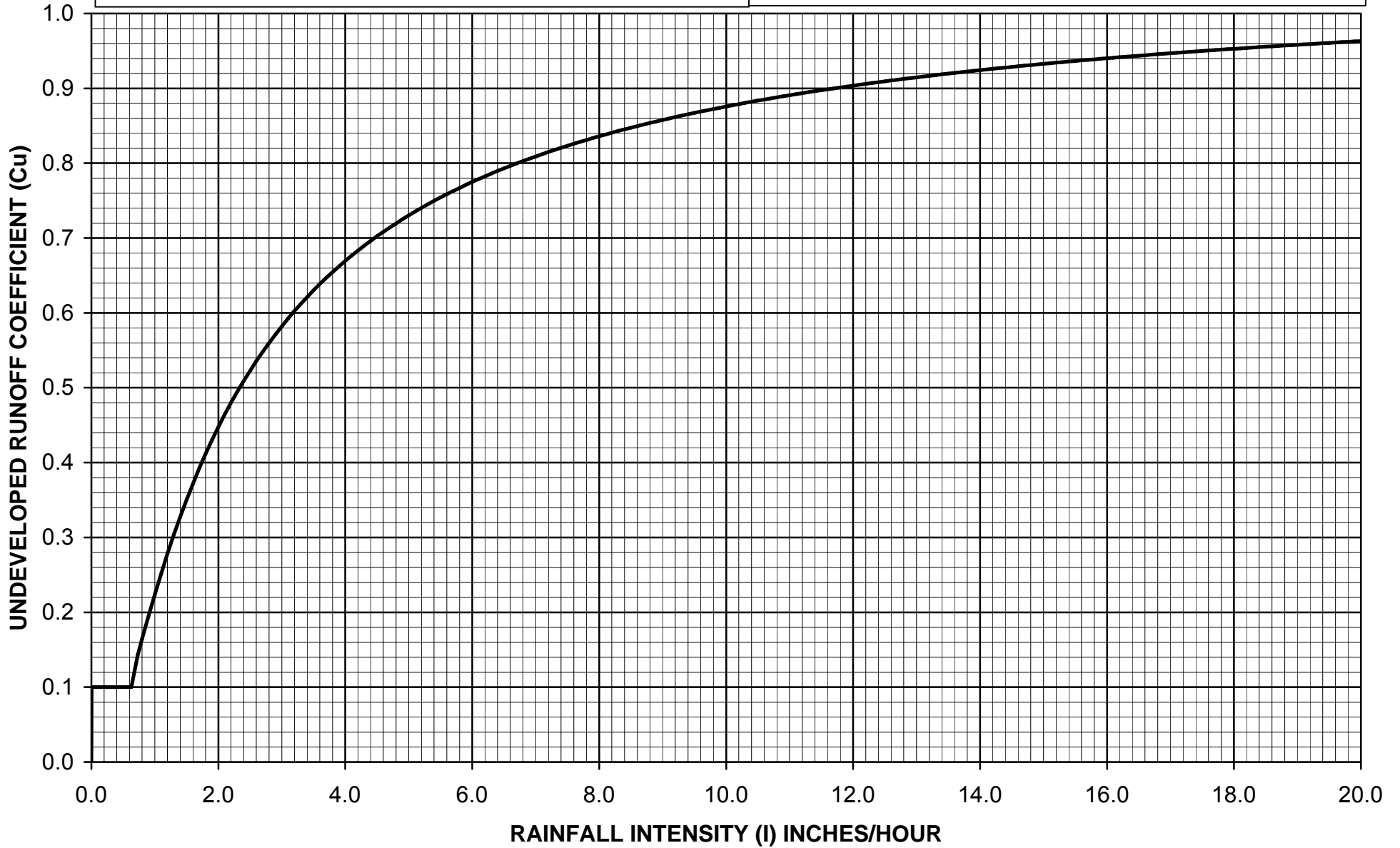

$C_D = (0.9 * IMP) + (1.0 - IMP) * C_U$
 Where: C_D = Developed Runoff Coefficient
 IMP = Proportion Impervious
 C_U = Undeveloped runoff coefficient



Los Angeles County Department of Public Works

RUNOFF COEFFICIENT CURVE
SOIL TYPE NO. 085

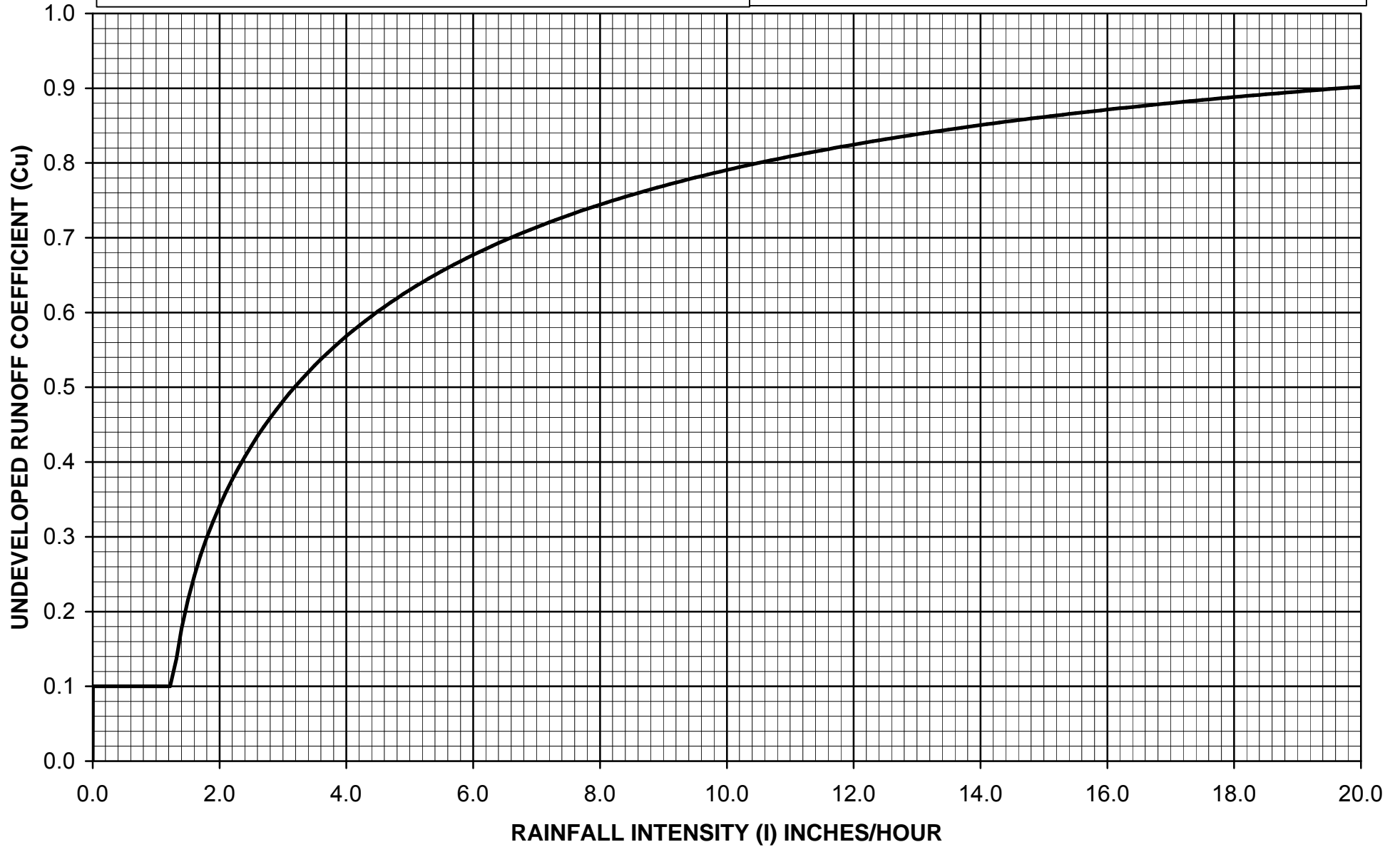

$C_D = (0.9 * IMP) + (1.0 - IMP) * C_U$
 Where: C_D = Developed Runoff Coefficient
 IMP = Proportion Impervious
 C_U = Undeveloped runoff coefficient



Los Angeles County Department of Public Works

RUNOFF COEFFICIENT CURVE
SOIL TYPE NO. 086

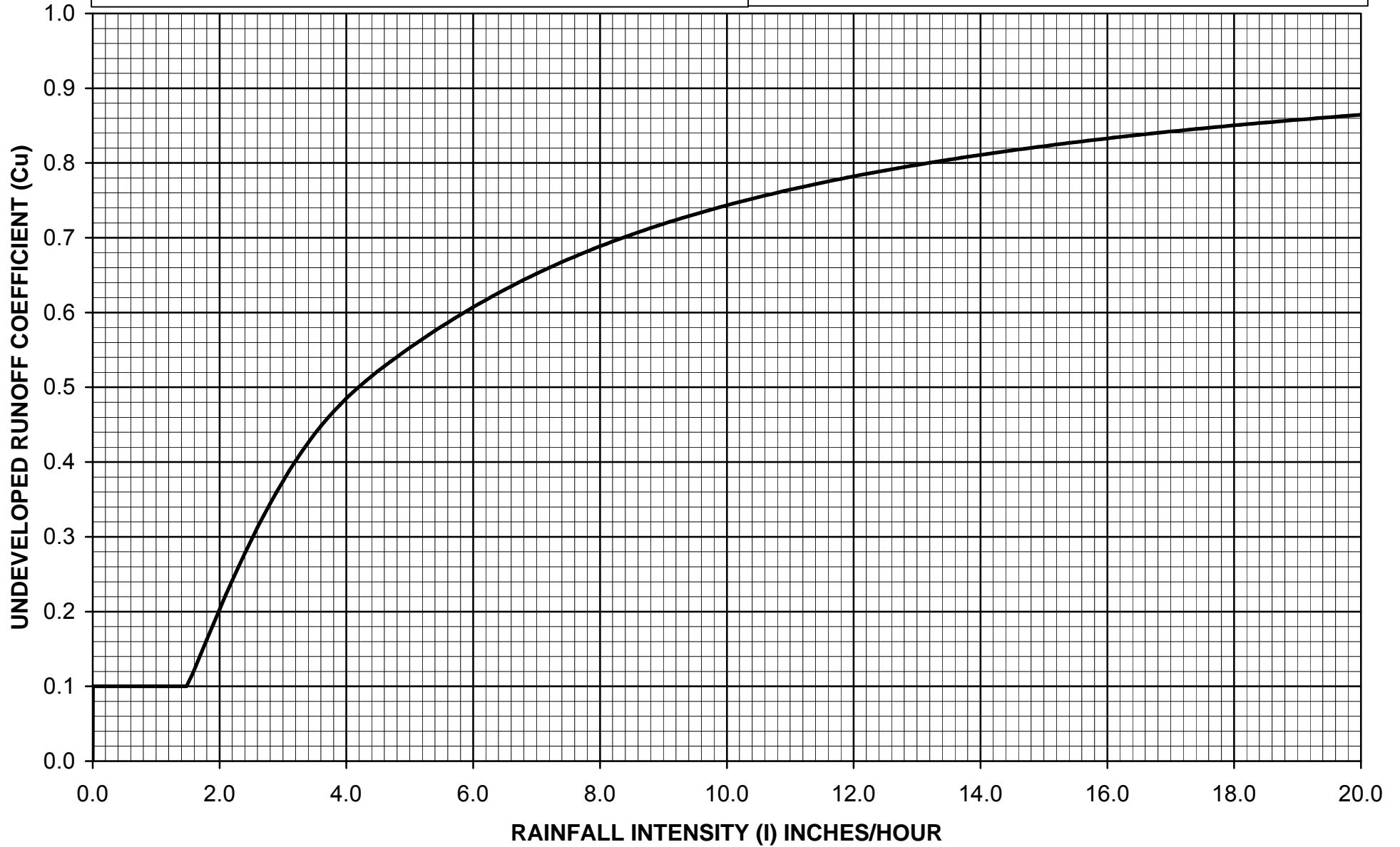

$$C_D = (0.9 * IMP) + (1.0 - IMP) * C_U$$

Where: C_D = Developed Runoff Coefficient
IMP = Proportion Impervious
 C_U = Undeveloped runoff coefficient



Los Angeles County Department of Public Works

RUNOFF COEFFICIENT CURVE
SOIL TYPE NO. 087

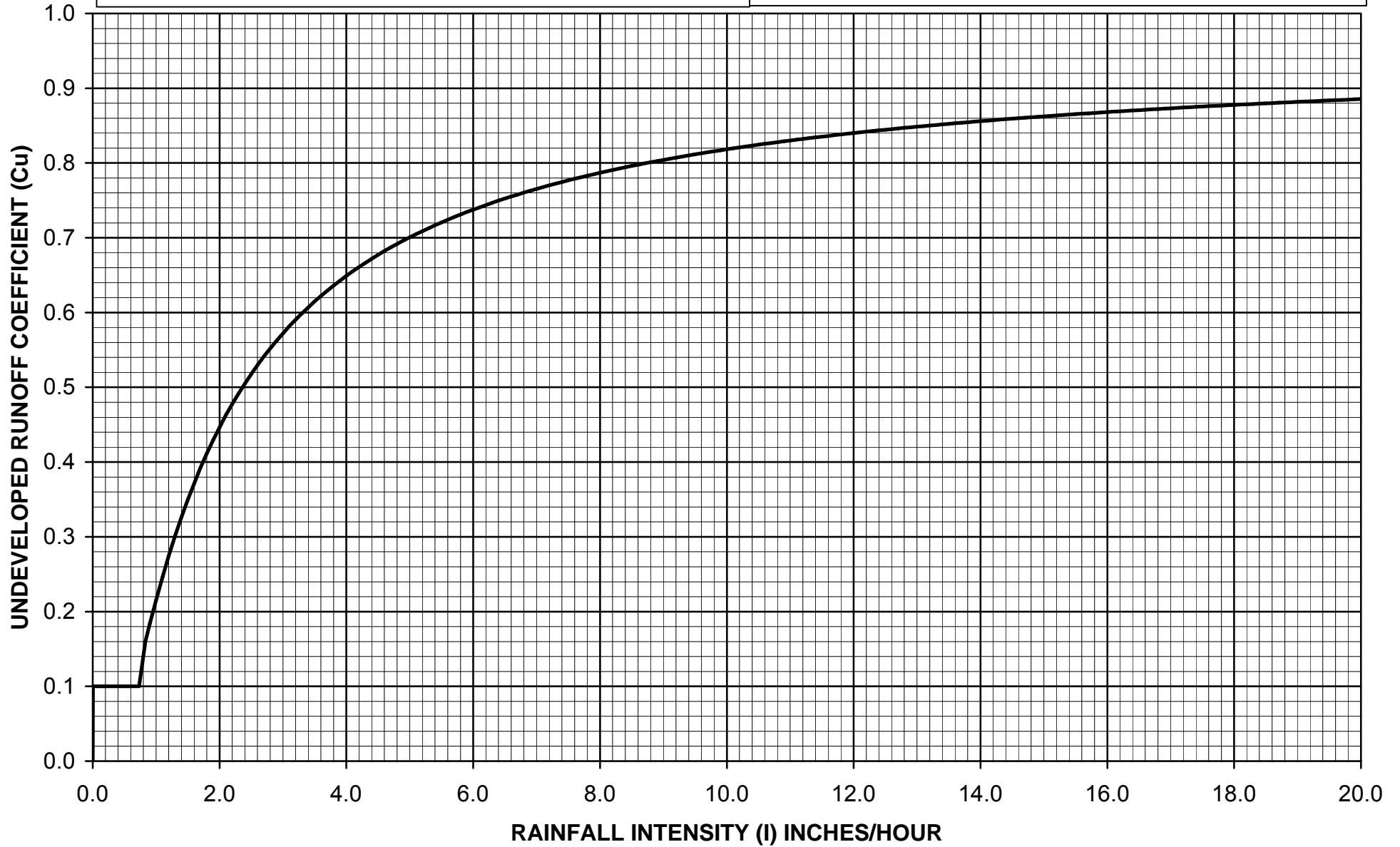

$$C_D = (0.9 * IMP) + (1.0 - IMP) * C_U$$

Where: C_D = Developed Runoff Coefficient
IMP = Proportion Impervious
 C_U = Undeveloped runoff coefficient



Los Angeles County Department of Public Works

RUNOFF COEFFICIENT CURVE
SOIL TYPE NO. 088

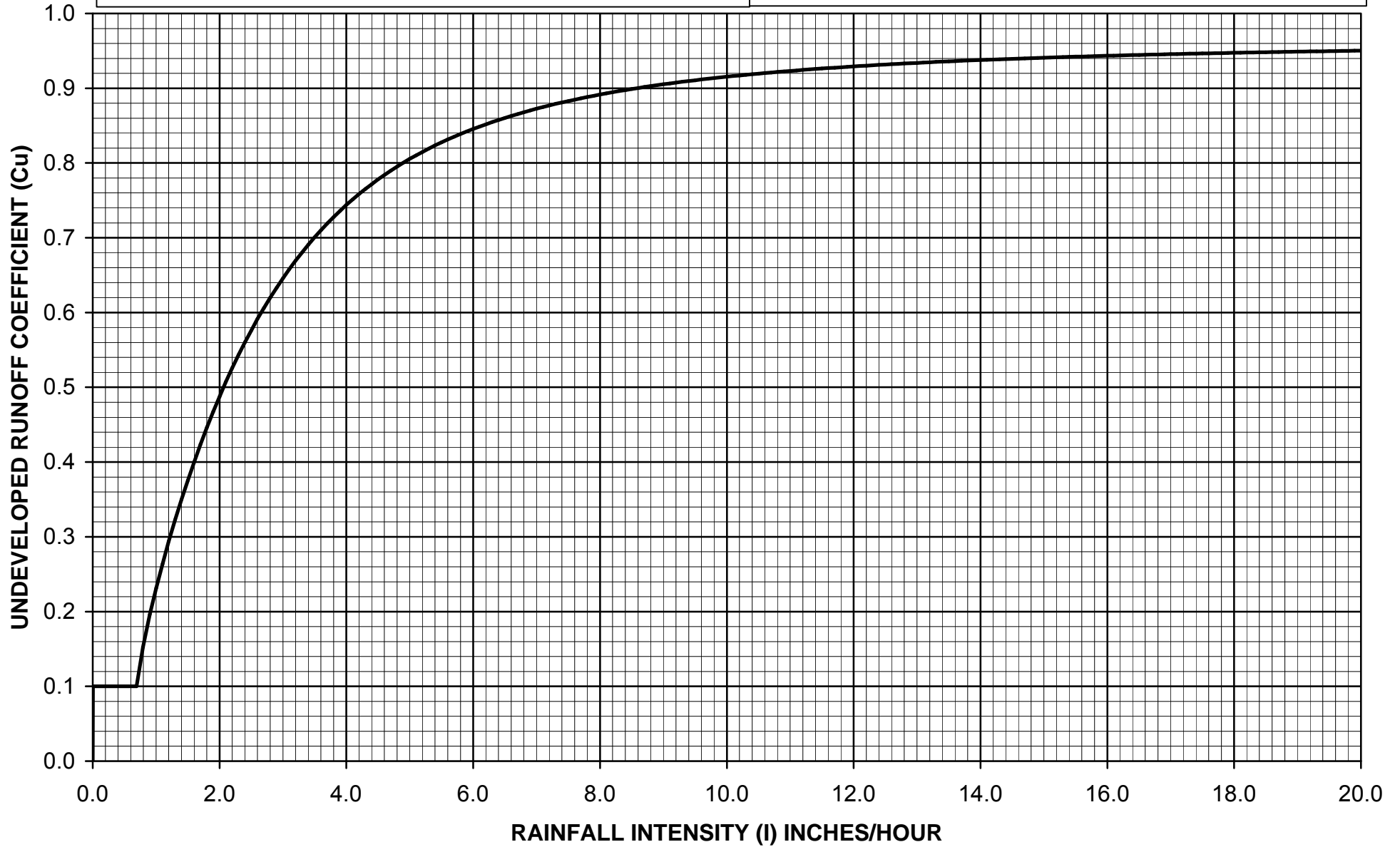

$C_D = (0.9 * IMP) + (1.0 - IMP) * C_U$
 Where: C_D = Developed Runoff Coefficient
 IMP = Proportion Impervious
 C_U = Undeveloped runoff coefficient



Los Angeles County Department of Public Works

RUNOFF COEFFICIENT CURVE
SOIL TYPE NO. 089

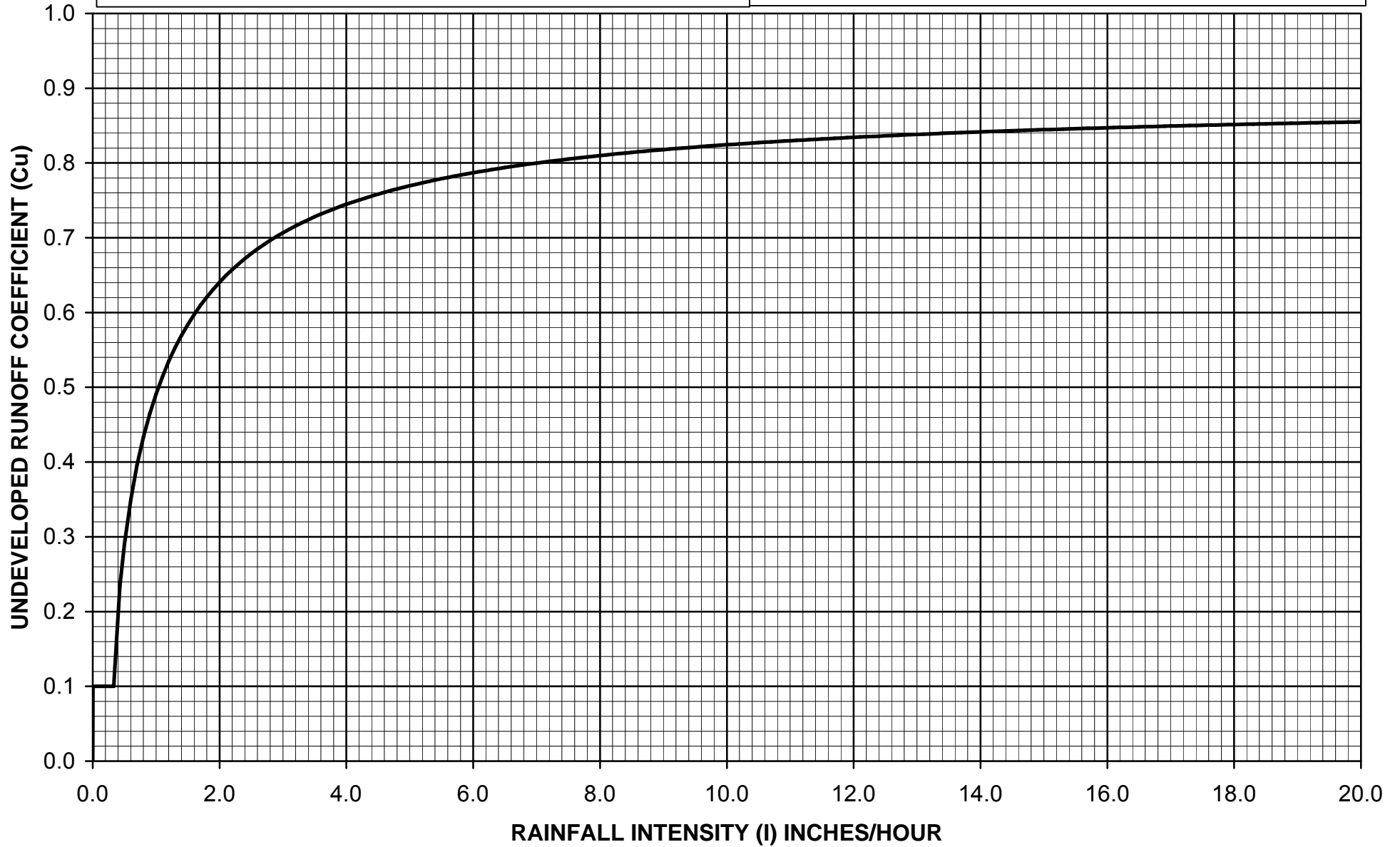

$C_D = (0.9 * IMP) + (1.0 - IMP) * C_U$
 Where: C_D = Developed Runoff Coefficient
 IMP = Proportion Impervious
 C_U = Undeveloped runoff coefficient



Los Angeles County Department of Public Works

RUNOFF COEFFICIENT CURVE
SOIL TYPE NO. 090

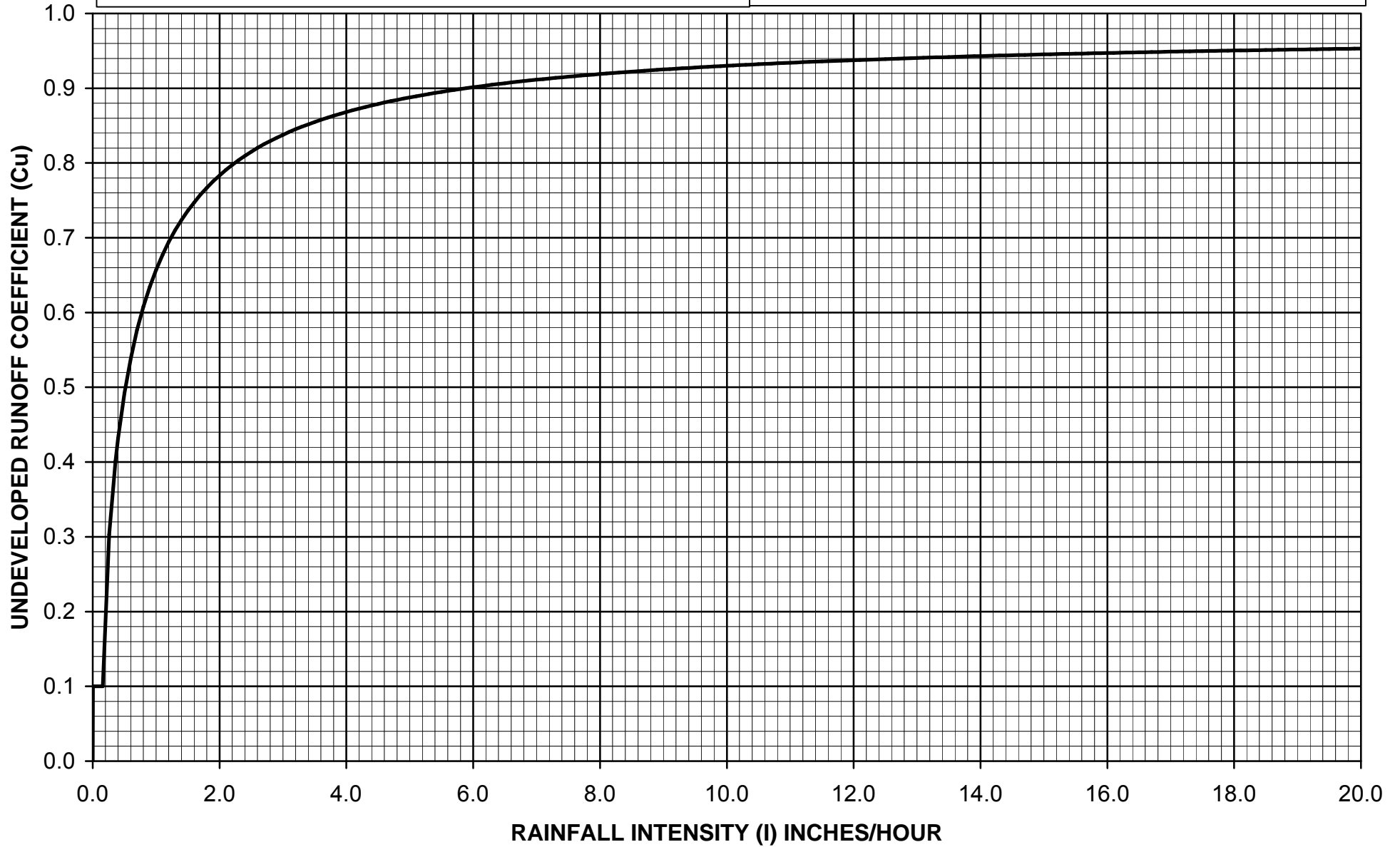

$C_D = (0.9 * IMP) + (1.0 - IMP) * C_U$
 Where: C_D = Developed Runoff Coefficient
 IMP = Proportion Impervious
 C_U = Undeveloped runoff coefficient



Los Angeles County Department of Public Works

RUNOFF COEFFICIENT CURVE
SOIL TYPE NO. 091

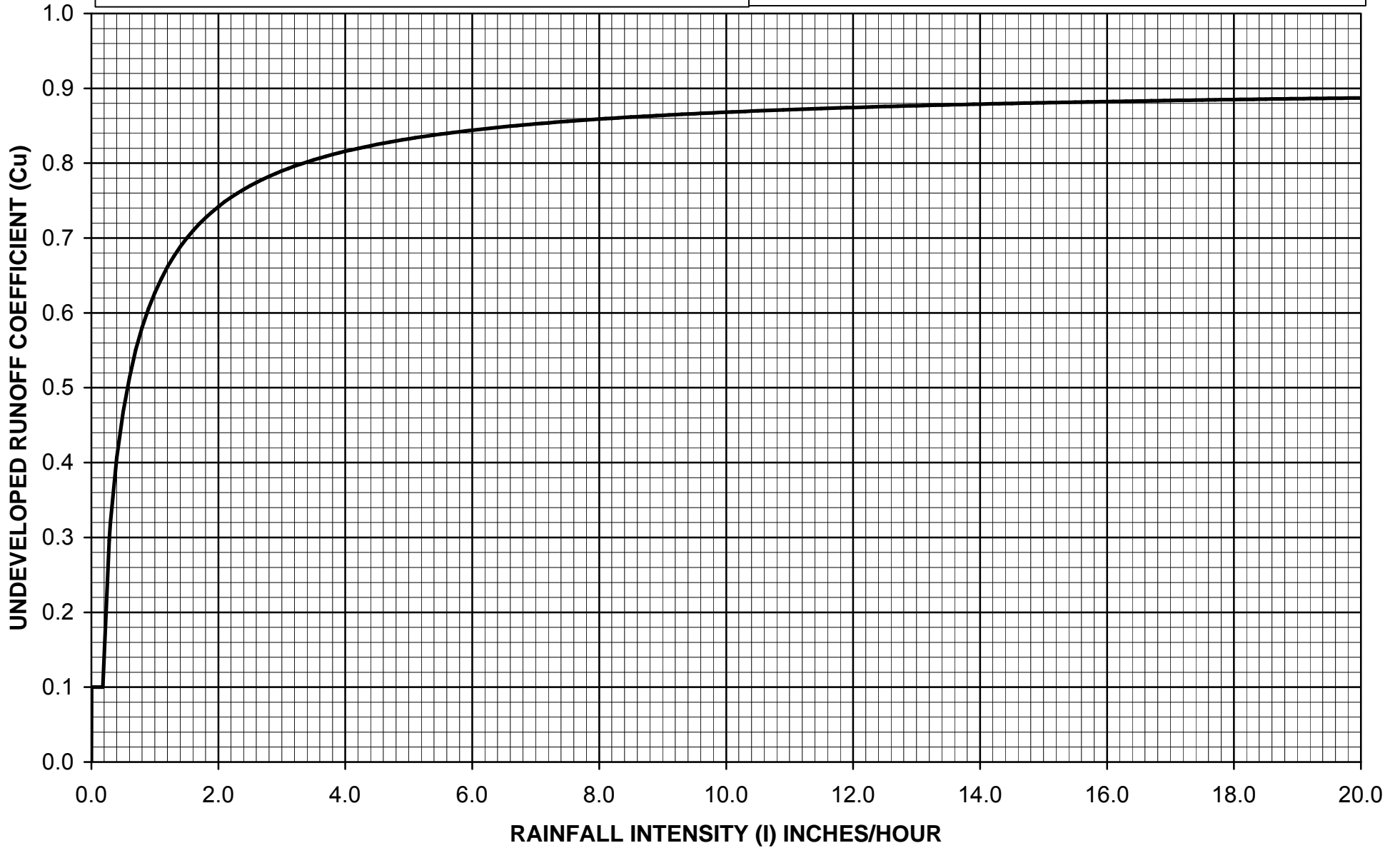

$C_D = (0.9 * IMP) + (1.0 - IMP) * C_U$
 Where: C_D = Developed Runoff Coefficient
 IMP = Proportion Impervious
 C_U = Undeveloped runoff coefficient



Los Angeles County Department of Public Works

RUNOFF COEFFICIENT CURVE
SOIL TYPE NO. 092

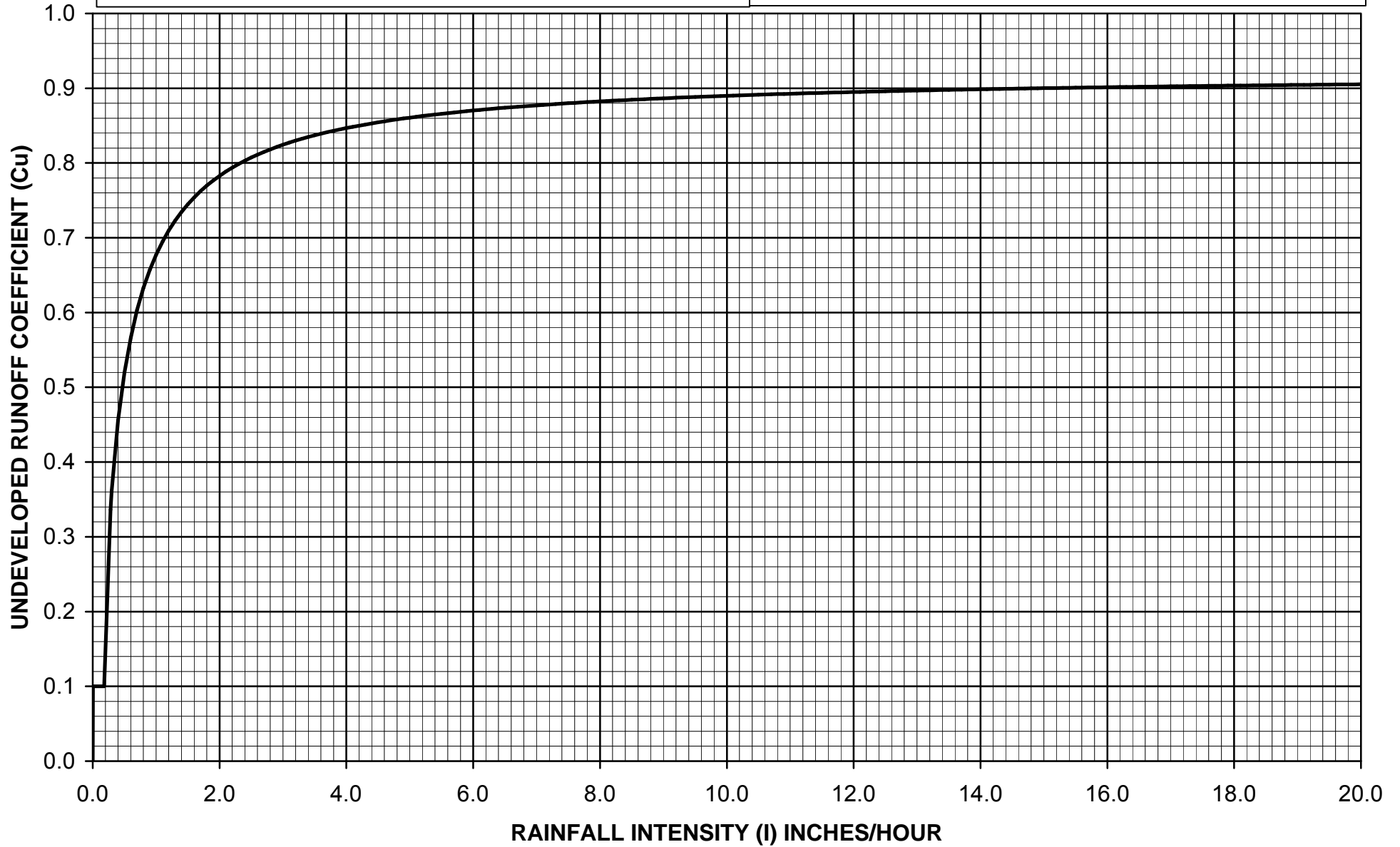

$C_D = (0.9 * IMP) + (1.0 - IMP) * C_U$
 Where: C_D = Developed Runoff Coefficient
 IMP = Proportion Impervious
 C_U = Undeveloped runoff coefficient



Los Angeles County Department of Public Works

RUNOFF COEFFICIENT CURVE
SOIL TYPE NO. 093

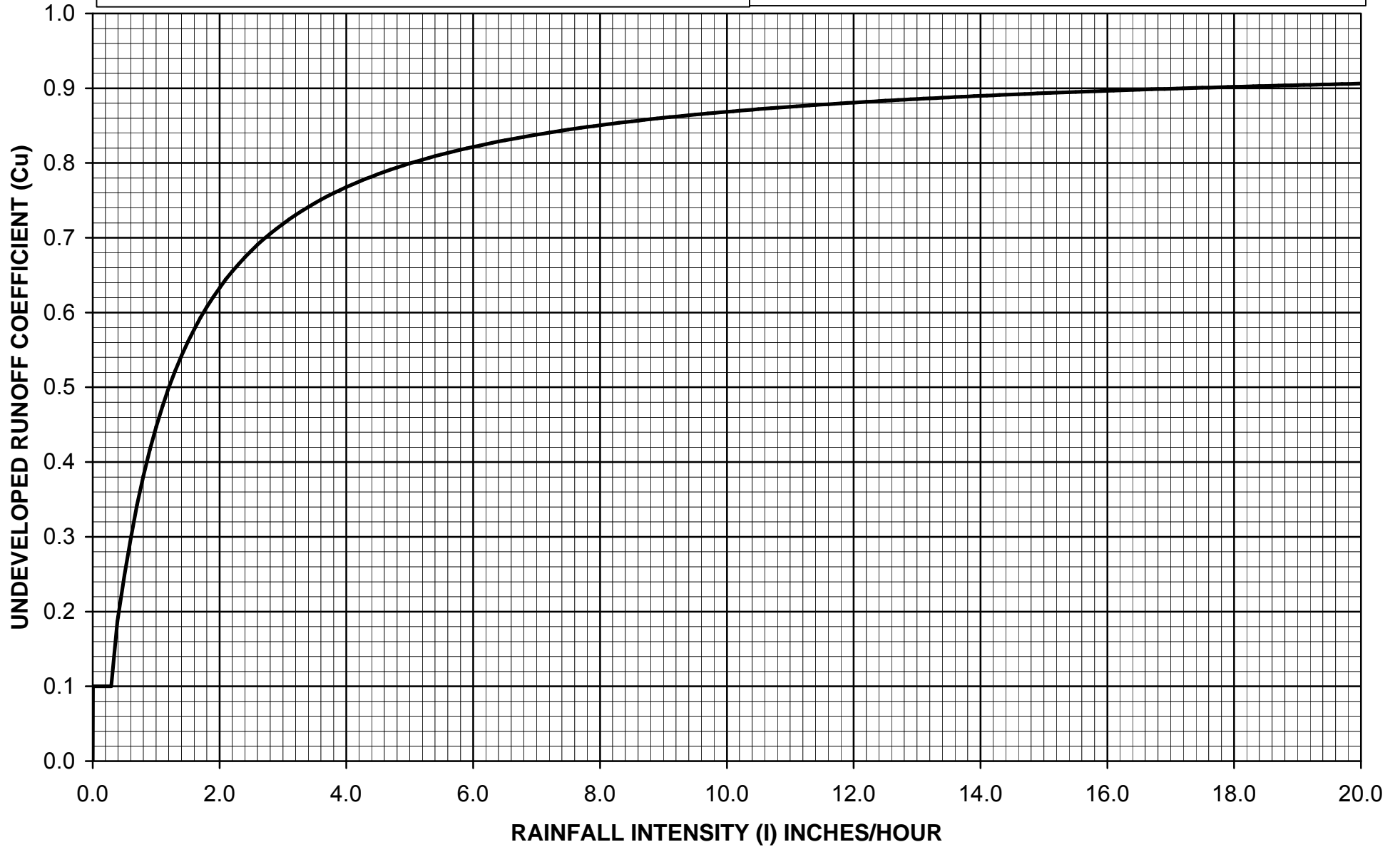

$C_D = (0.9 * IMP) + (1.0 - IMP) * C_U$
Where: C_D = Developed Runoff Coefficient
IMP = Proportion Impervious
 C_U = Undeveloped runoff coefficient



Los Angeles County Department of Public Works

RUNOFF COEFFICIENT CURVE
SOIL TYPE NO. 094

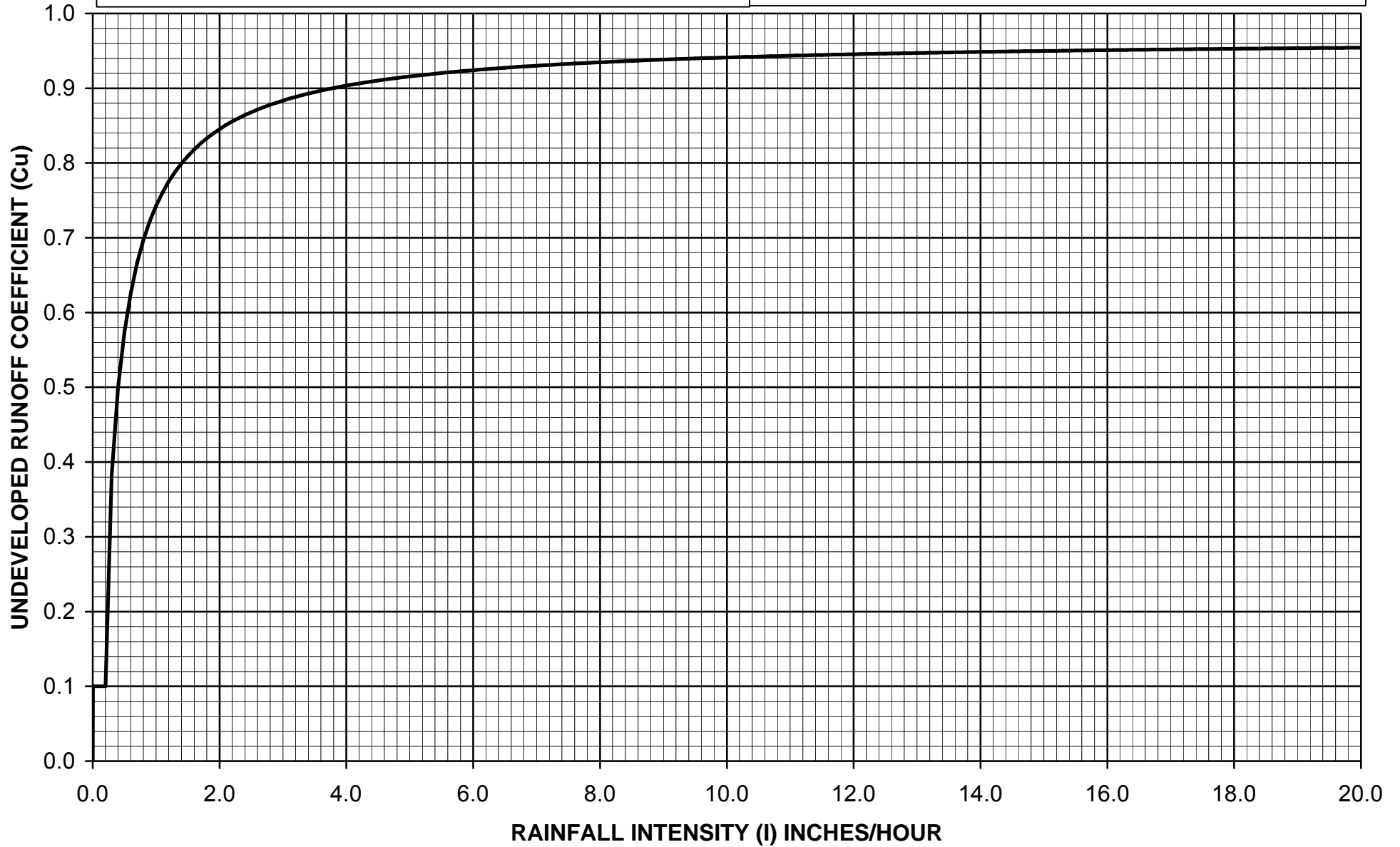

$C_D = (0.9 * IMP) + (1.0 - IMP) * C_U$
 Where: C_D = Developed Runoff Coefficient
 IMP = Proportion Impervious
 C_U = Undeveloped runoff coefficient



Los Angeles County Department of Public Works

RUNOFF COEFFICIENT CURVE
SOIL TYPE NO. 095

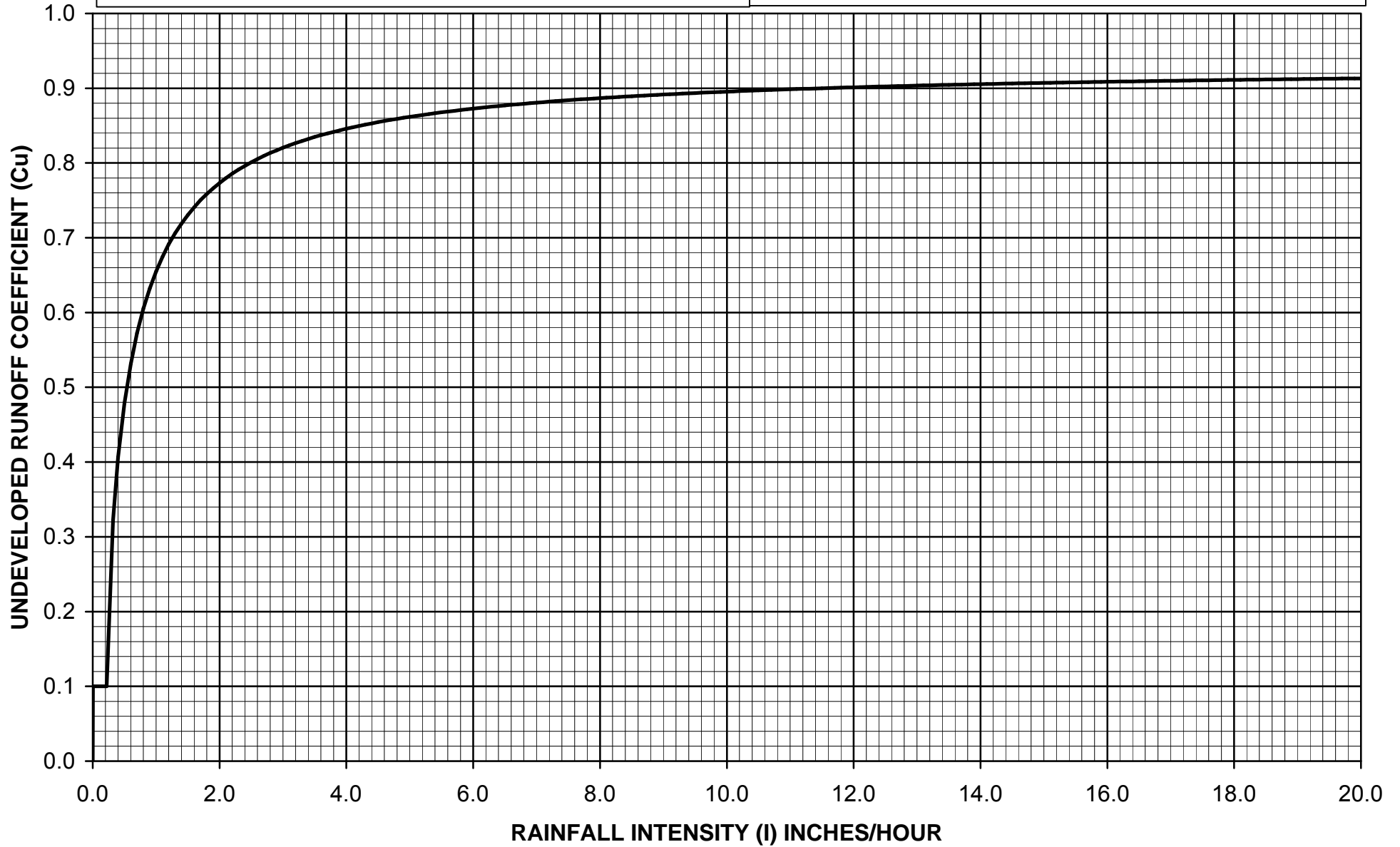

$C_D = (0.9 * IMP) + (1.0 - IMP) * C_U$
 Where: C_D = Developed Runoff Coefficient
 IMP = Proportion Impervious
 C_U = Undeveloped runoff coefficient



Los Angeles County Department of Public Works

RUNOFF COEFFICIENT CURVE
SOIL TYPE NO. 096

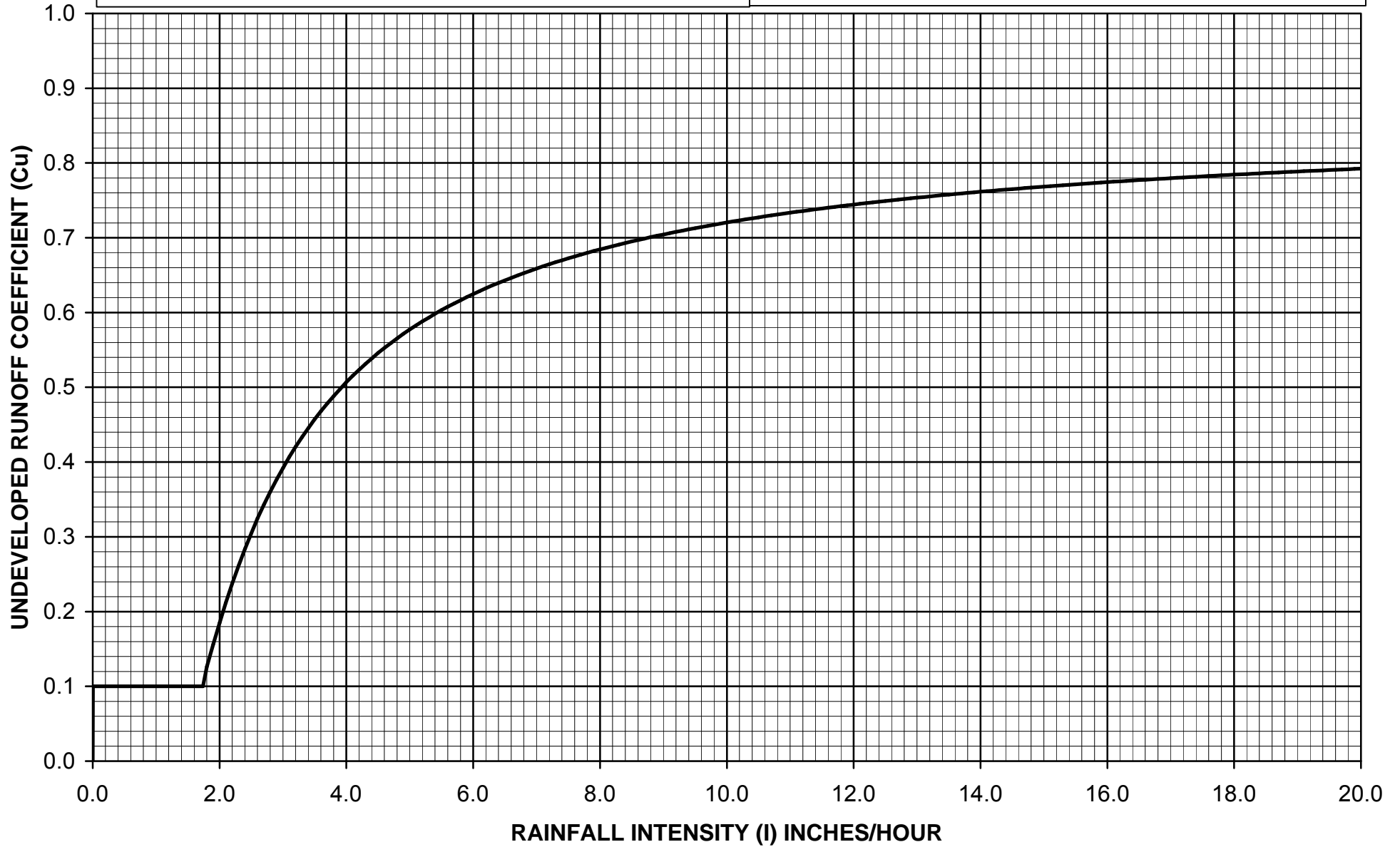

$C_D = (0.9 * IMP) + (1.0 - IMP) * C_U$
 Where: C_D = Developed Runoff Coefficient
 IMP = Proportion Impervious
 C_U = Undeveloped runoff coefficient



Los Angeles County Department of Public Works

RUNOFF COEFFICIENT CURVE
SOIL TYPE NO. 097

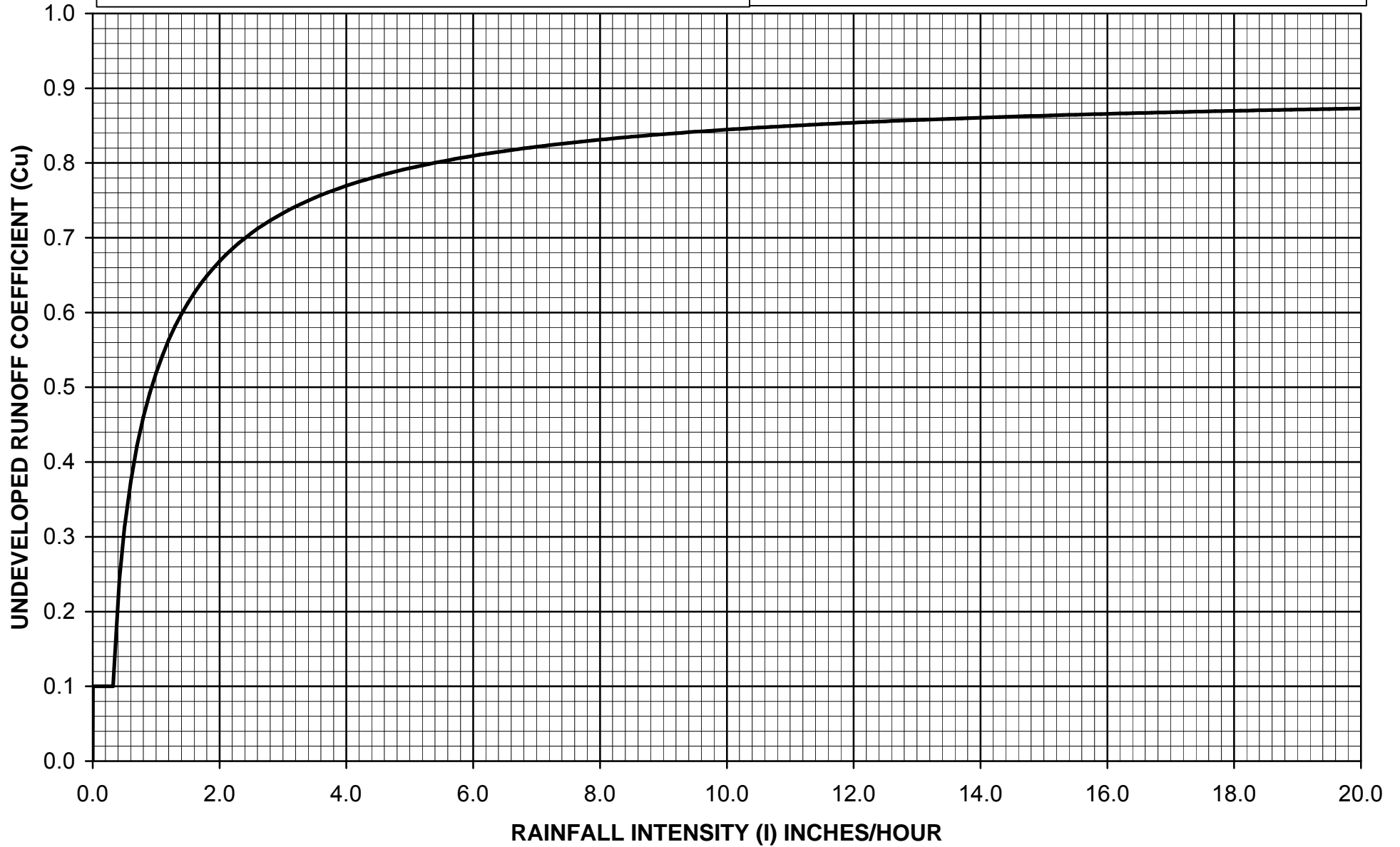

$C_D = (0.9 * IMP) + (1.0 - IMP) * C_U$
 Where: C_D = Developed Runoff Coefficient
 IMP = Proportion Impervious
 C_U = Undeveloped runoff coefficient



Los Angeles County Department of Public Works

RUNOFF COEFFICIENT CURVE
SOIL TYPE NO. 098

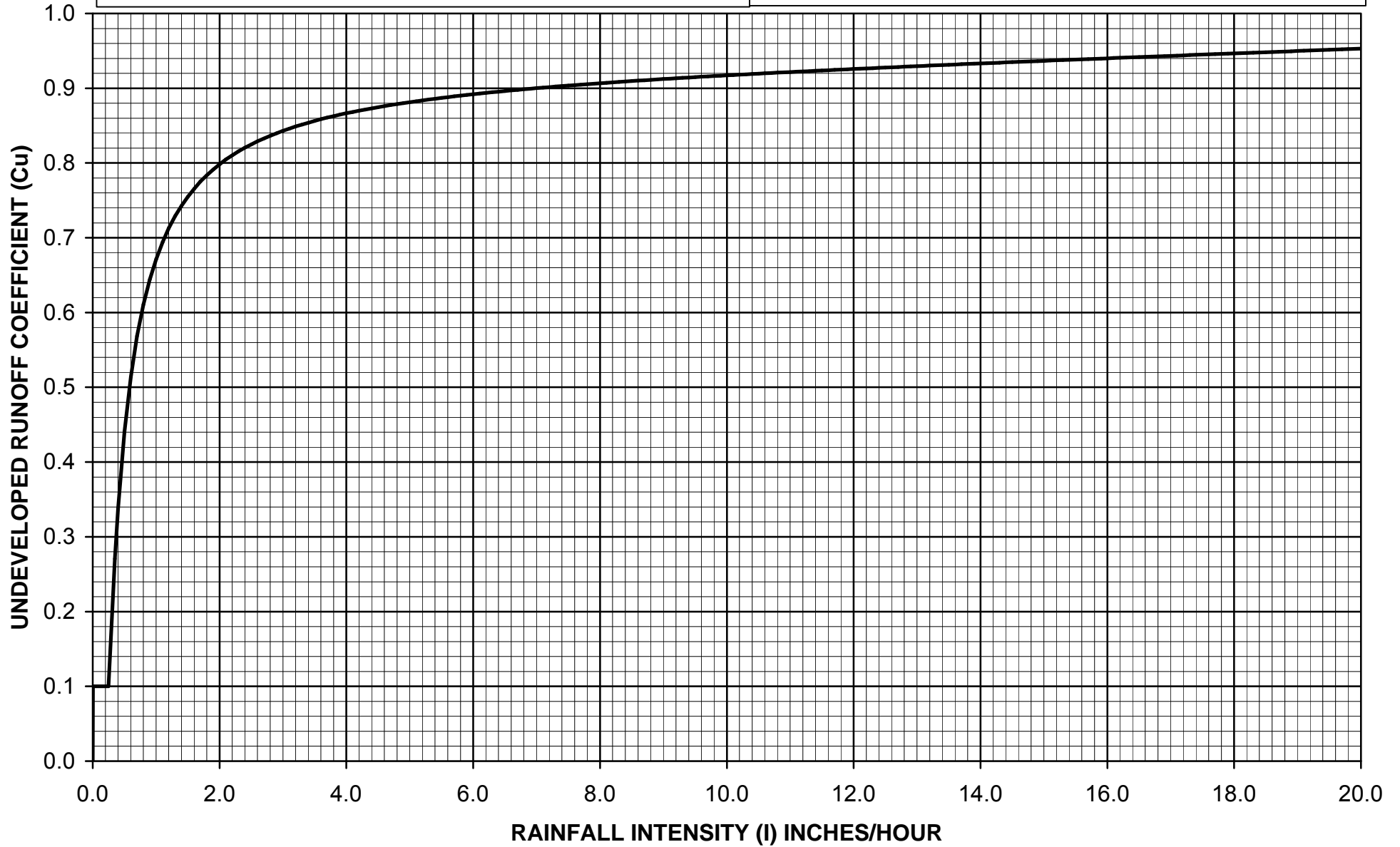

$C_D = (0.9 * IMP) + (1.0 - IMP) * C_U$
 Where: C_D = Developed Runoff Coefficient
 IMP = Proportion Impervious
 C_U = Undeveloped runoff coefficient



Los Angeles County Department of Public Works

RUNOFF COEFFICIENT CURVE
SOIL TYPE NO. 099

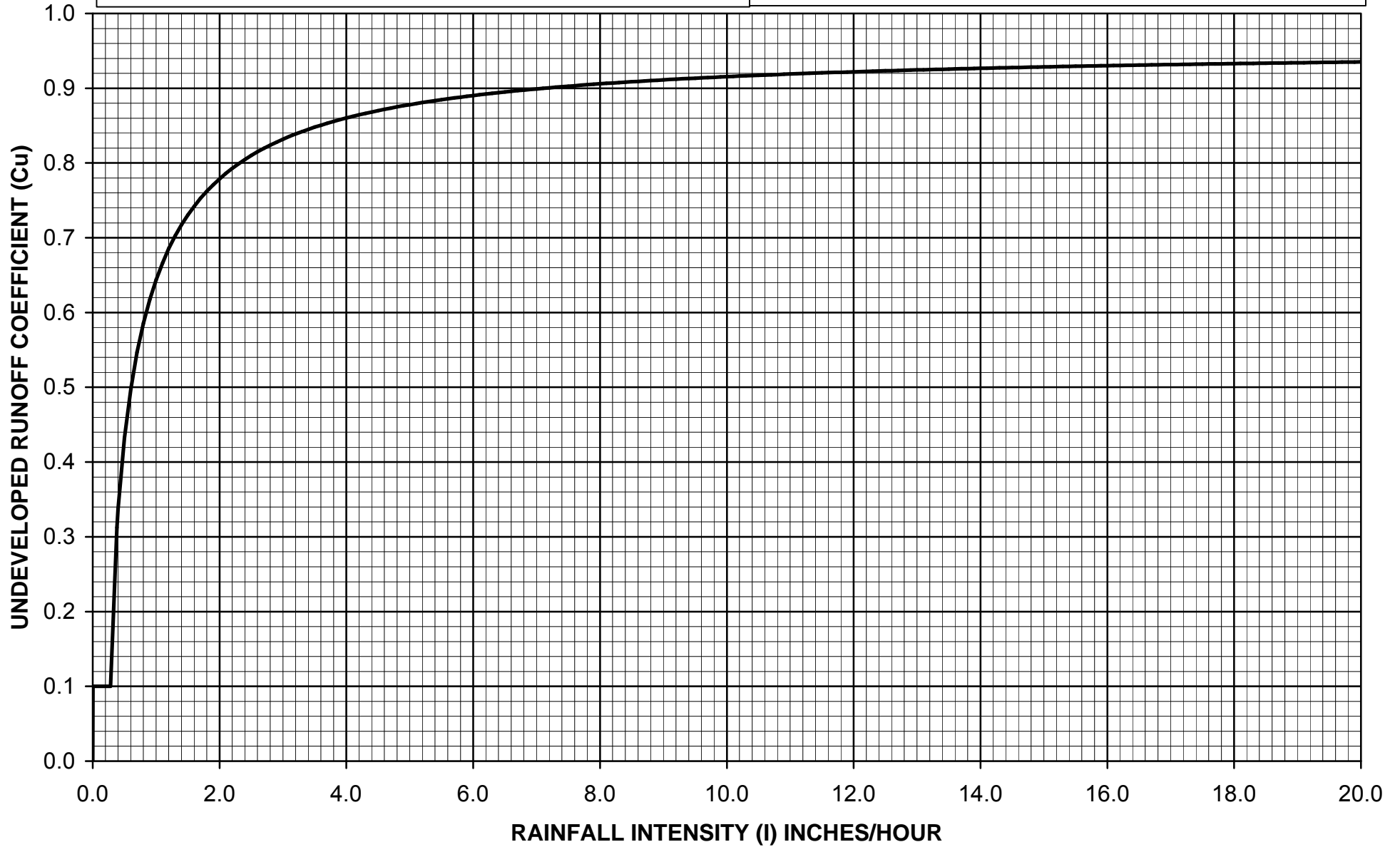

$C_D = (0.9 * IMP) + (1.0 - IMP) * C_U$
 Where: C_D = Developed Runoff Coefficient
 IMP = Proportion Impervious
 C_U = Undeveloped runoff coefficient



Los Angeles County Department of Public Works

**RUNOFF COEFFICIENT CURVE
SOIL TYPE NO. 100**

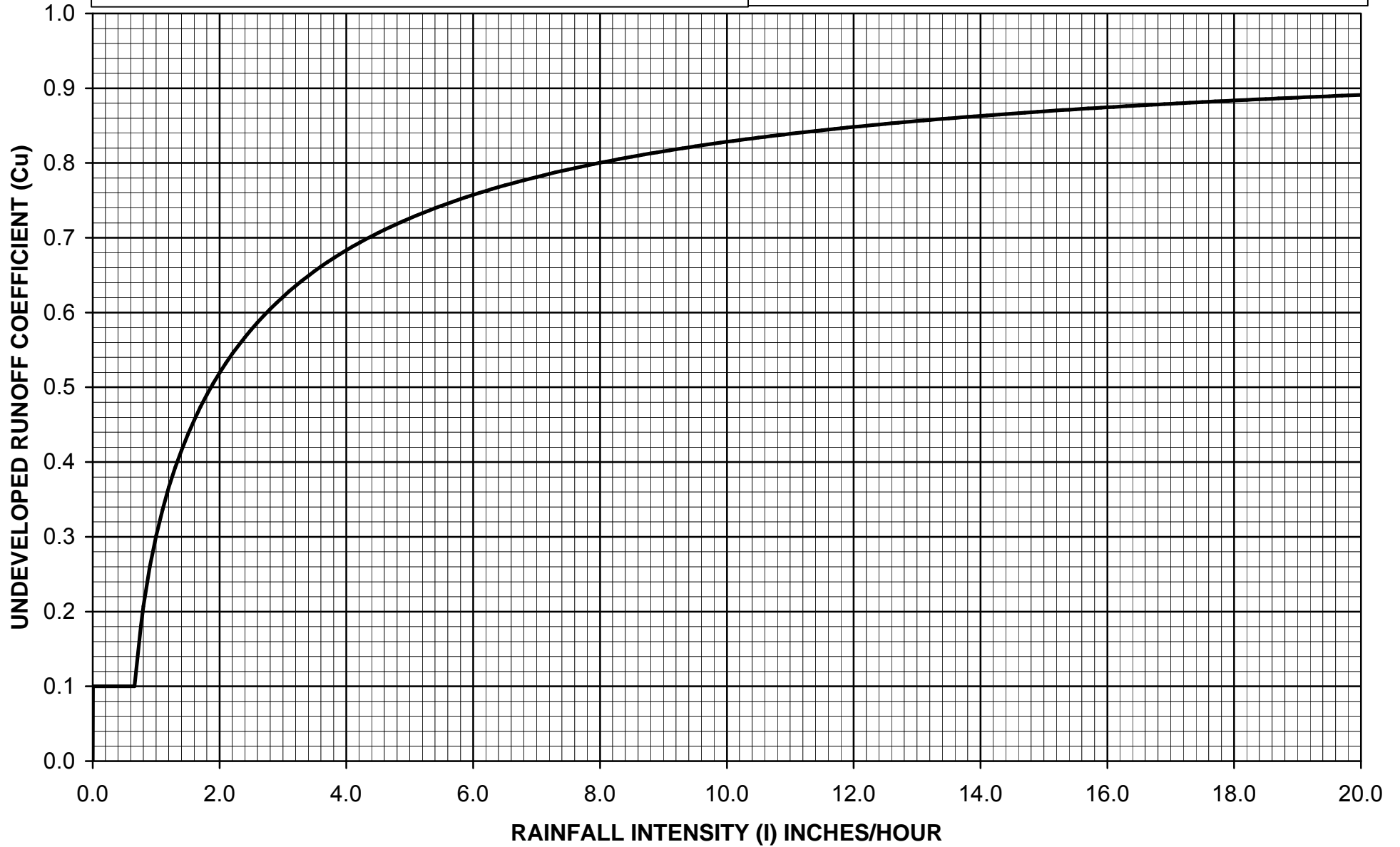

$C_D = (0.9 * IMP) + (1.0 - IMP) * C_U$
 Where: C_D = Developed Runoff Coefficient
 IMP = Proportion Impervious
 C_U = Undeveloped runoff coefficient



Los Angeles County Department of Public Works

**RUNOFF COEFFICIENT CURVE
SOIL TYPE NO. 101**

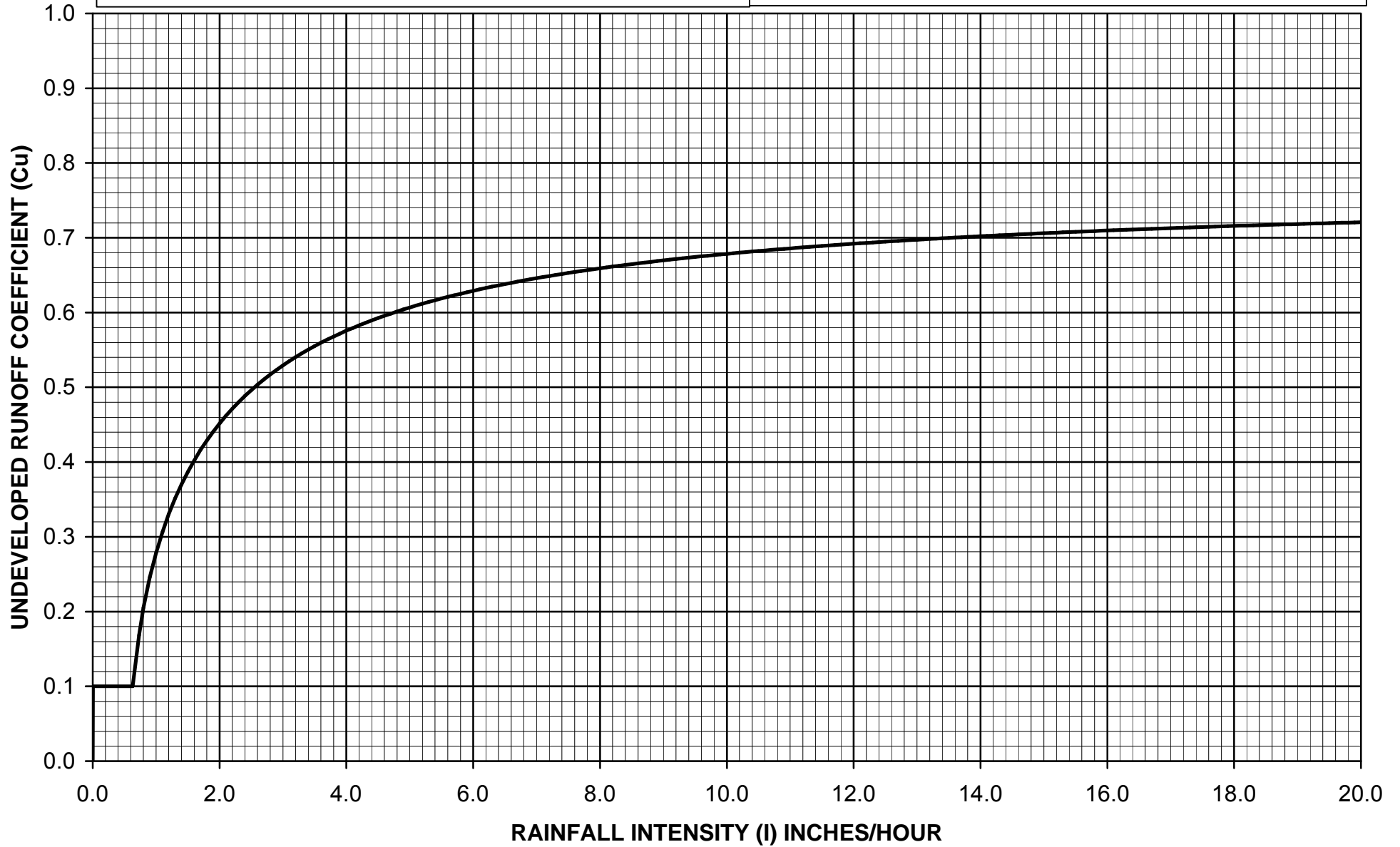

$C_D = (0.9 * IMP) + (1.0 - IMP) * C_U$
 Where: C_D = Developed Runoff Coefficient
 IMP = Proportion Impervious
 C_U = Undeveloped runoff coefficient



Los Angeles County Department of Public Works

RUNOFF COEFFICIENT CURVE
SOIL TYPE NO. 102

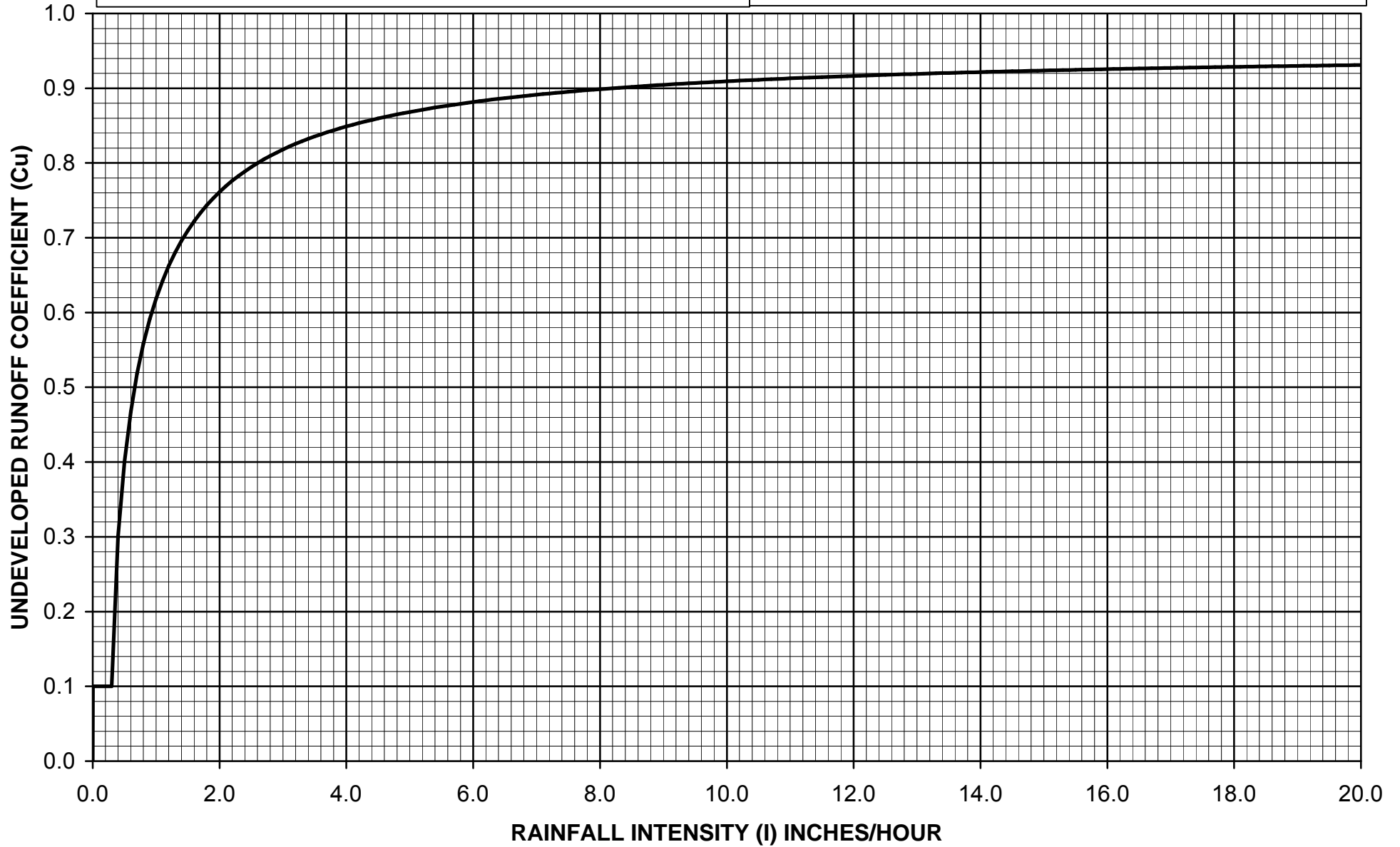

$$C_D = (0.9 * IMP) + (1.0 - IMP) * C_U$$

Where: C_D = Developed Runoff Coefficient

IMP = Proportion Impervious

C_U = Undeveloped runoff coefficient



Los Angeles County Department of Public Works

RUNOFF COEFFICIENT CURVE
SOIL TYPE NO. 103

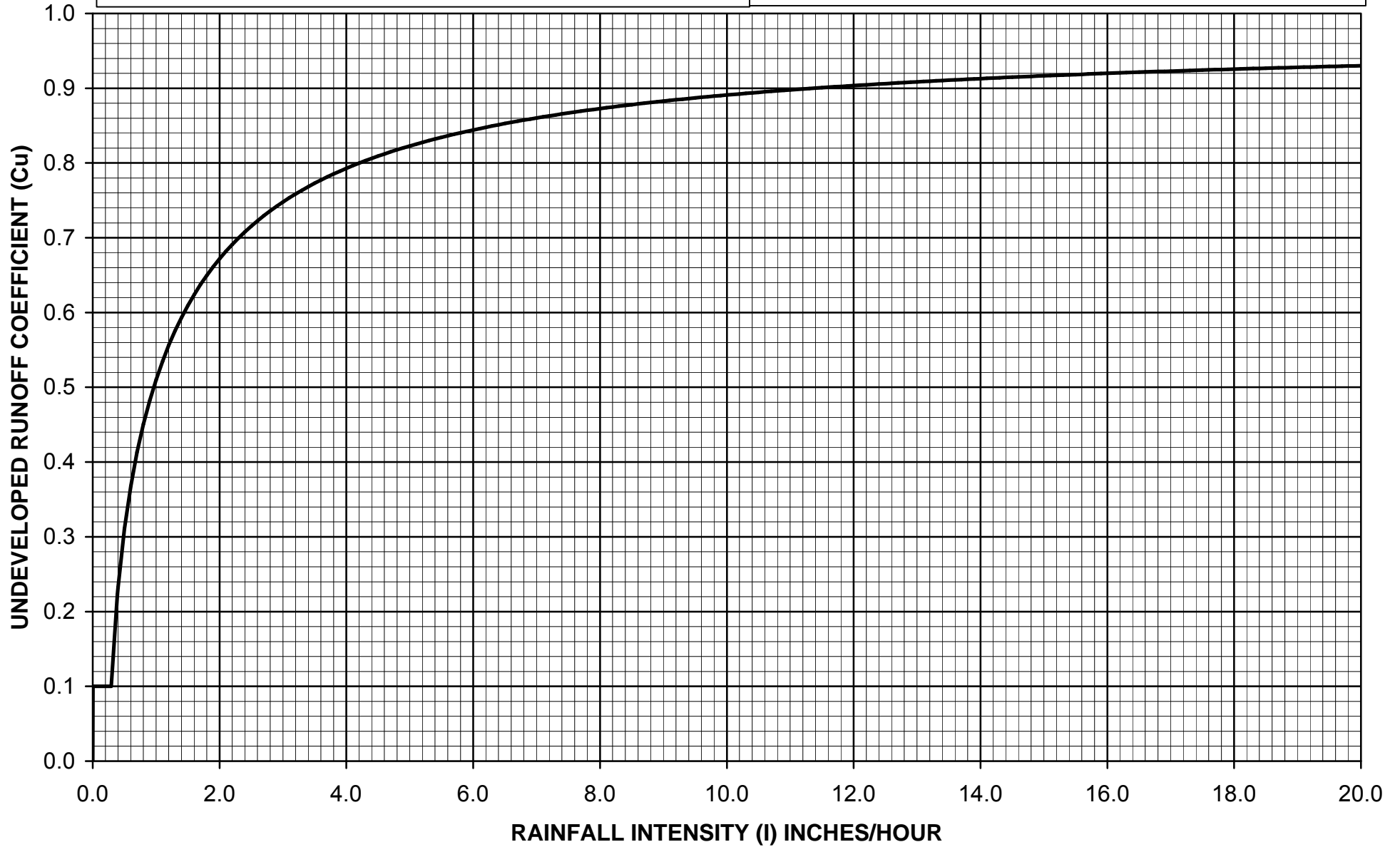

$$C_D = (0.9 * IMP) + (1.0 - IMP) * C_U$$

Where: C_D = Developed Runoff Coefficient
IMP = Proportion Impervious
 C_U = Undeveloped runoff coefficient



Los Angeles County Department of Public Works

RUNOFF COEFFICIENT CURVE
SOIL TYPE NO. 104

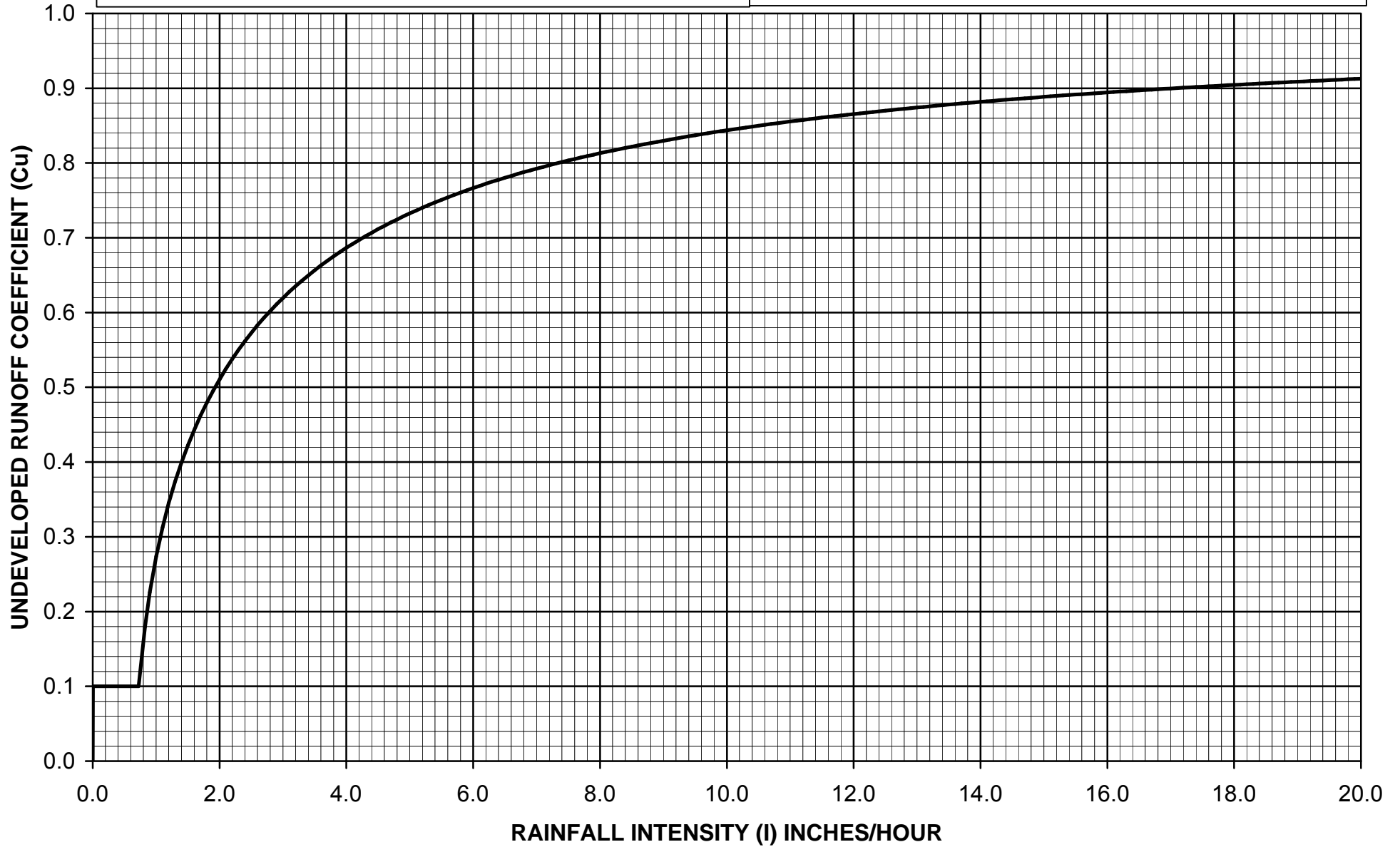

$C_D = (0.9 * IMP) + (1.0 - IMP) * C_U$
 Where: C_D = Developed Runoff Coefficient
 IMP = Proportion Impervious
 C_U = Undeveloped runoff coefficient



Los Angeles County Department of Public Works

RUNOFF COEFFICIENT CURVE
SOIL TYPE NO. 105

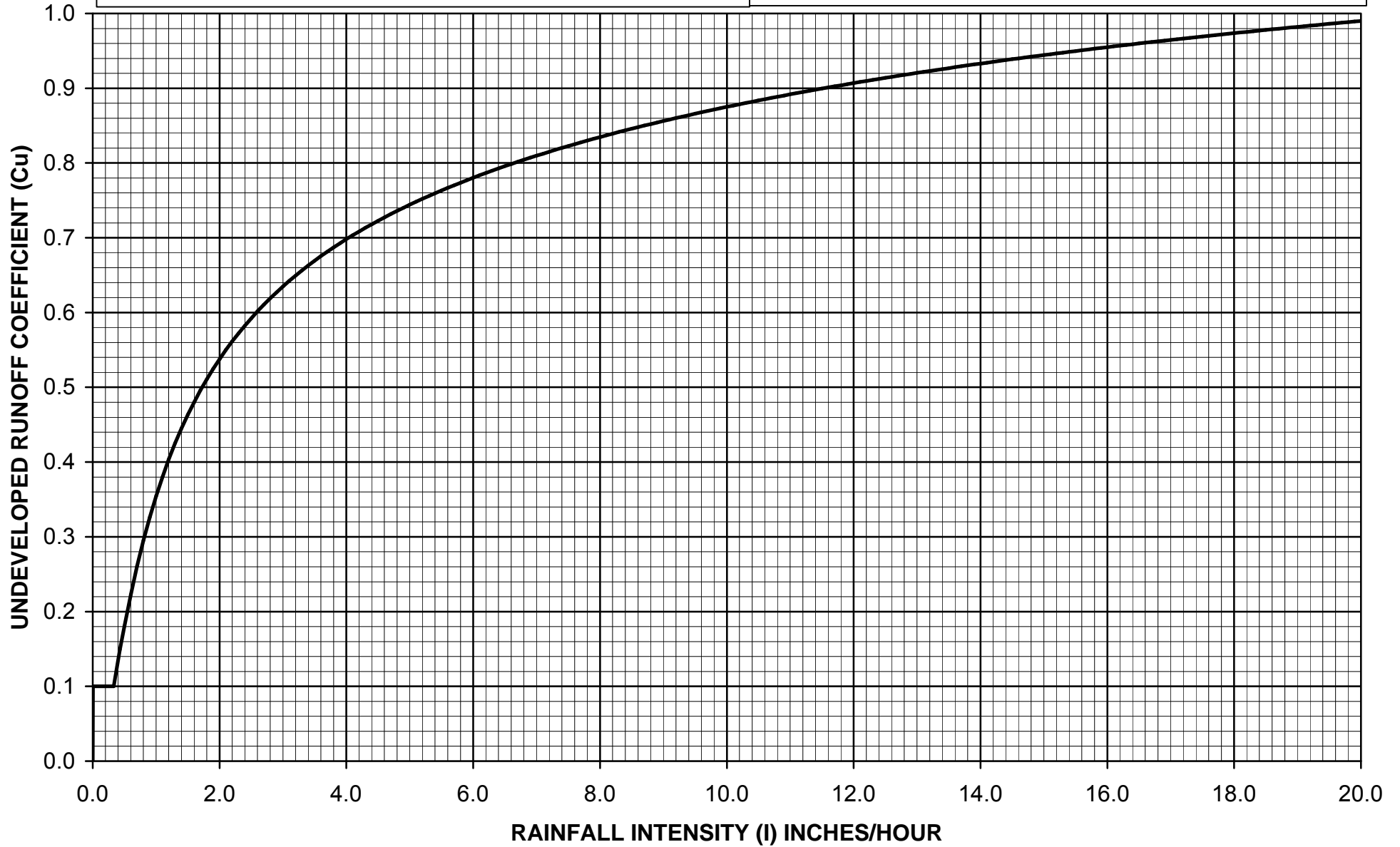

$C_D = (0.9 * IMP) + (1.0 - IMP) * C_U$
 Where: C_D = Developed Runoff Coefficient
 IMP = Proportion Impervious
 C_U = Undeveloped runoff coefficient



Los Angeles County Department of Public Works

RUNOFF COEFFICIENT CURVE
SOIL TYPE NO. 106

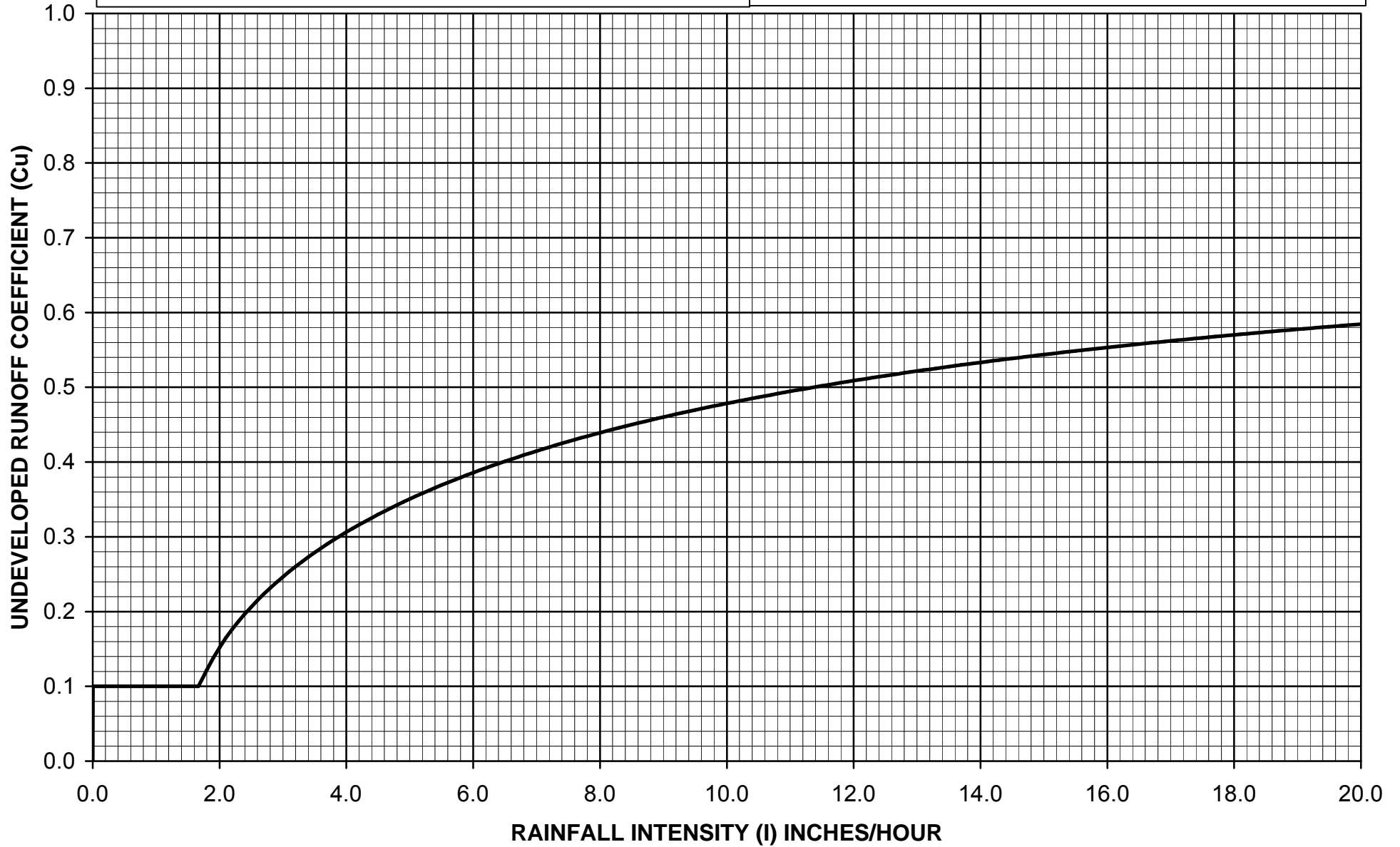

$C_D = (0.9 * IMP) + (1.0 - IMP) * C_U$
 Where: C_D = Developed Runoff Coefficient
 IMP = Proportion Impervious
 C_U = Undeveloped runoff coefficient



Los Angeles County Department of Public Works

RUNOFF COEFFICIENT CURVE
SOIL TYPE NO. 107

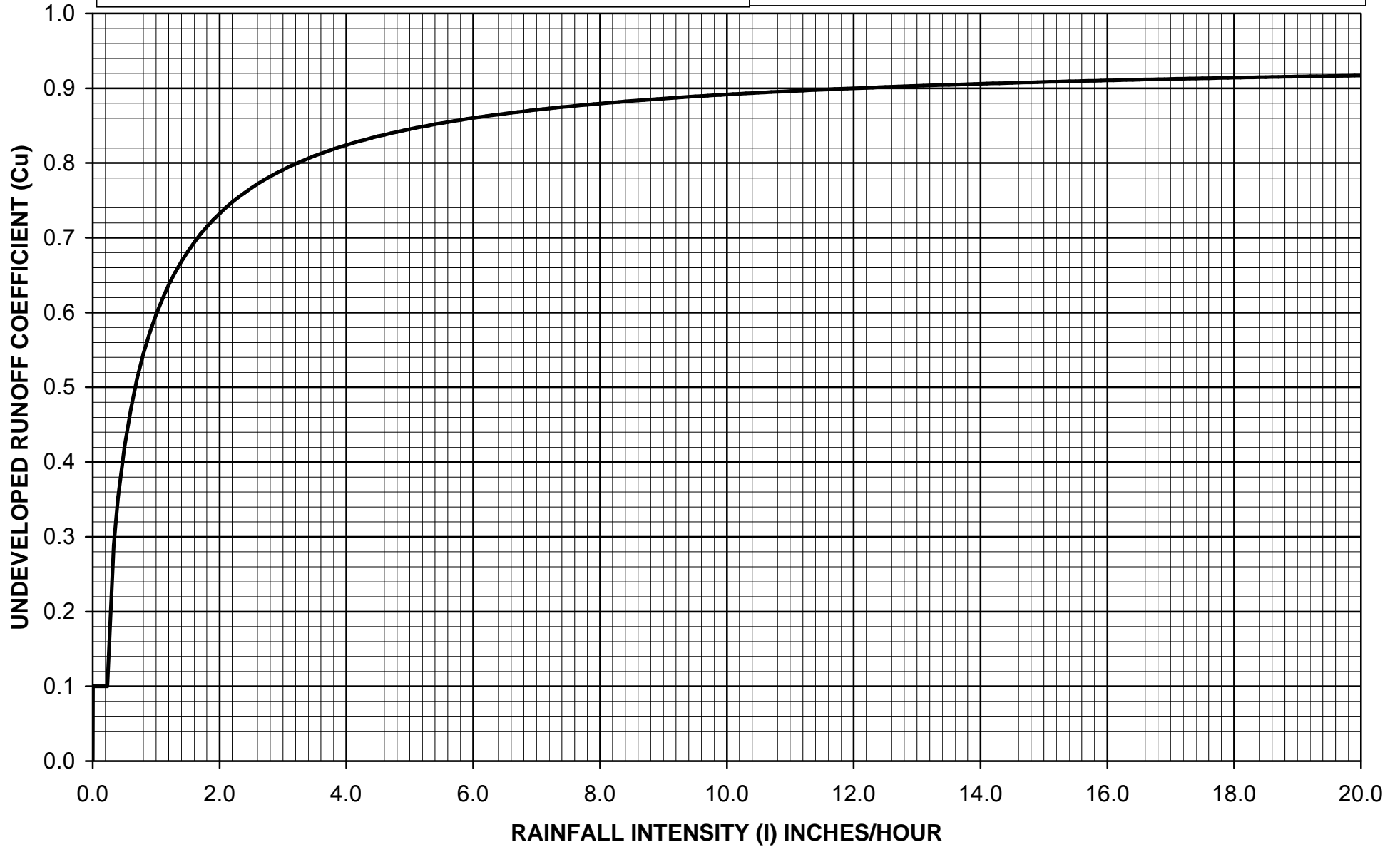

$$CD = (0.9 * IMP) + (1.0 - IMP) * Cu$$

Where: C_D = Developed Runoff Coefficient
IMP = Proportion Impervious
 C_U = Undeveloped runoff coefficient



Los Angeles County Department of Public Works

RUNOFF COEFFICIENT CURVE
SOIL TYPE NO. 108

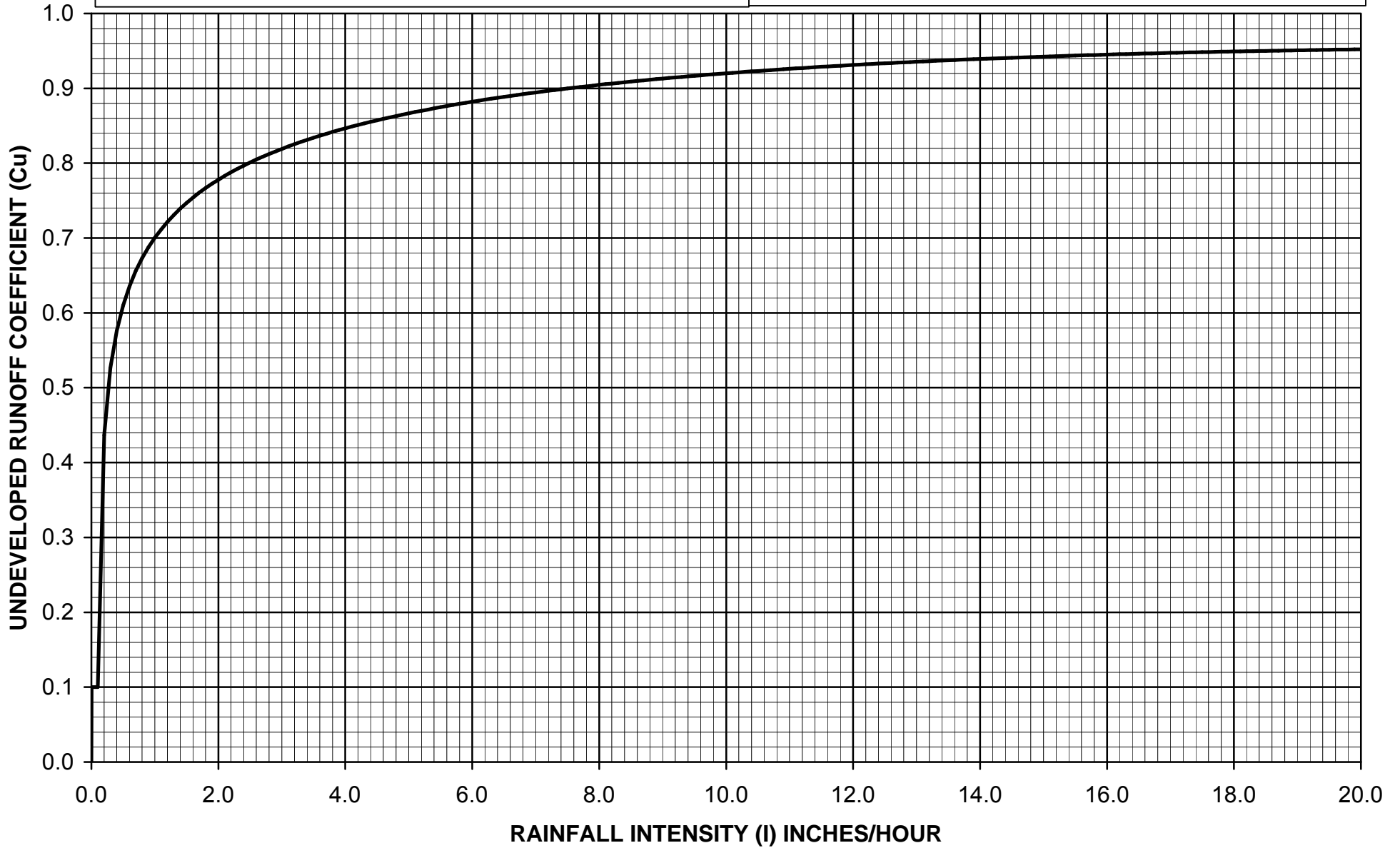

$$C_D = (0.9 * IMP) + (1.0 - IMP) * C_U$$

Where: C_D = Developed Runoff Coefficient
IMP = Proportion Impervious
 C_U = Undeveloped runoff coefficient



Los Angeles County Department of Public Works

RUNOFF COEFFICIENT CURVE
SOIL TYPE NO. 109

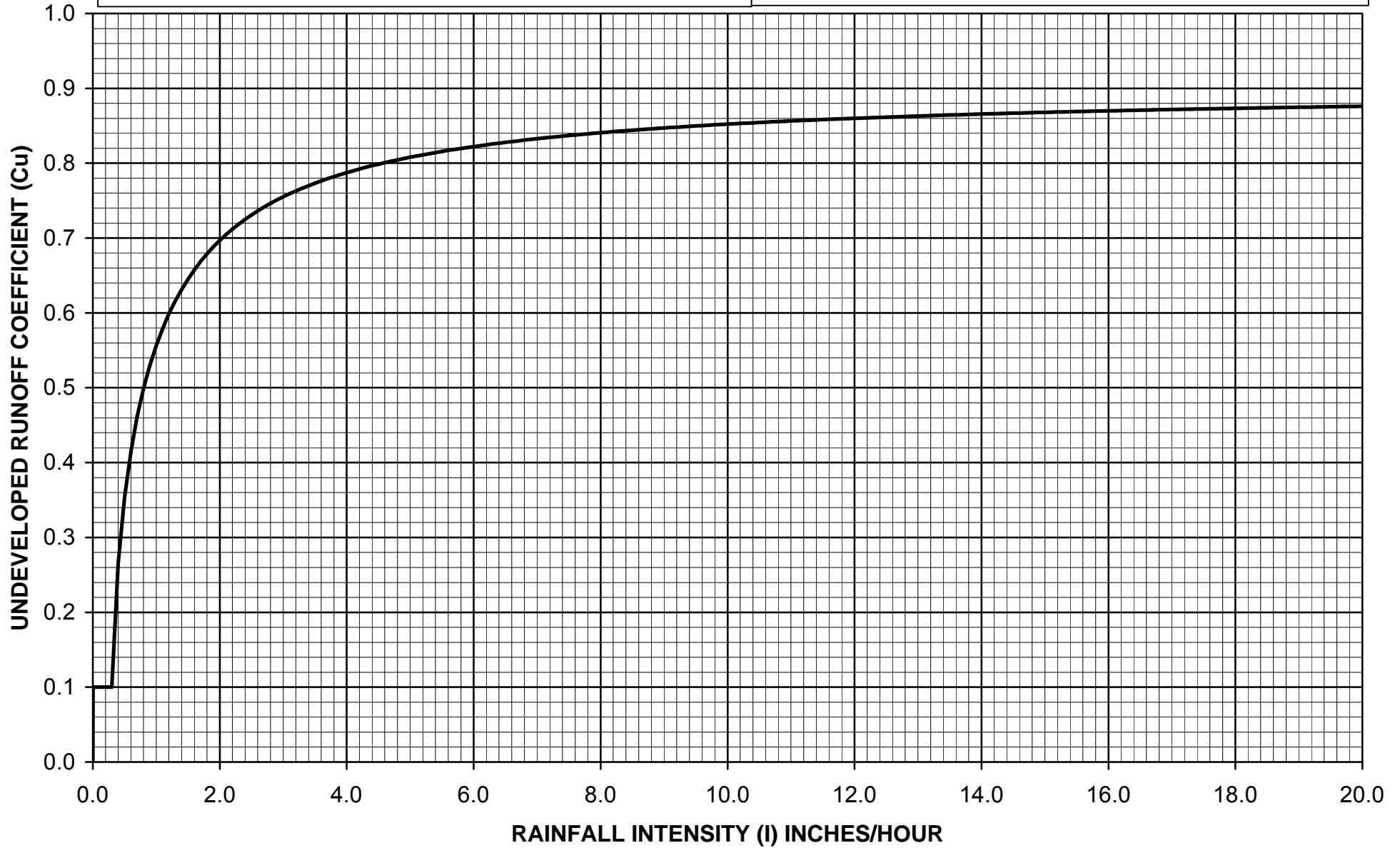

$C_D = (0.9 * IMP) + (1.0 - IMP) * C_U$
 Where: C_D = Developed Runoff Coefficient
 IMP = Proportion Impervious
 C_U = Undeveloped runoff coefficient



Los Angeles County Department of Public Works

RUNOFF COEFFICIENT CURVE
SOIL TYPE NO. 110

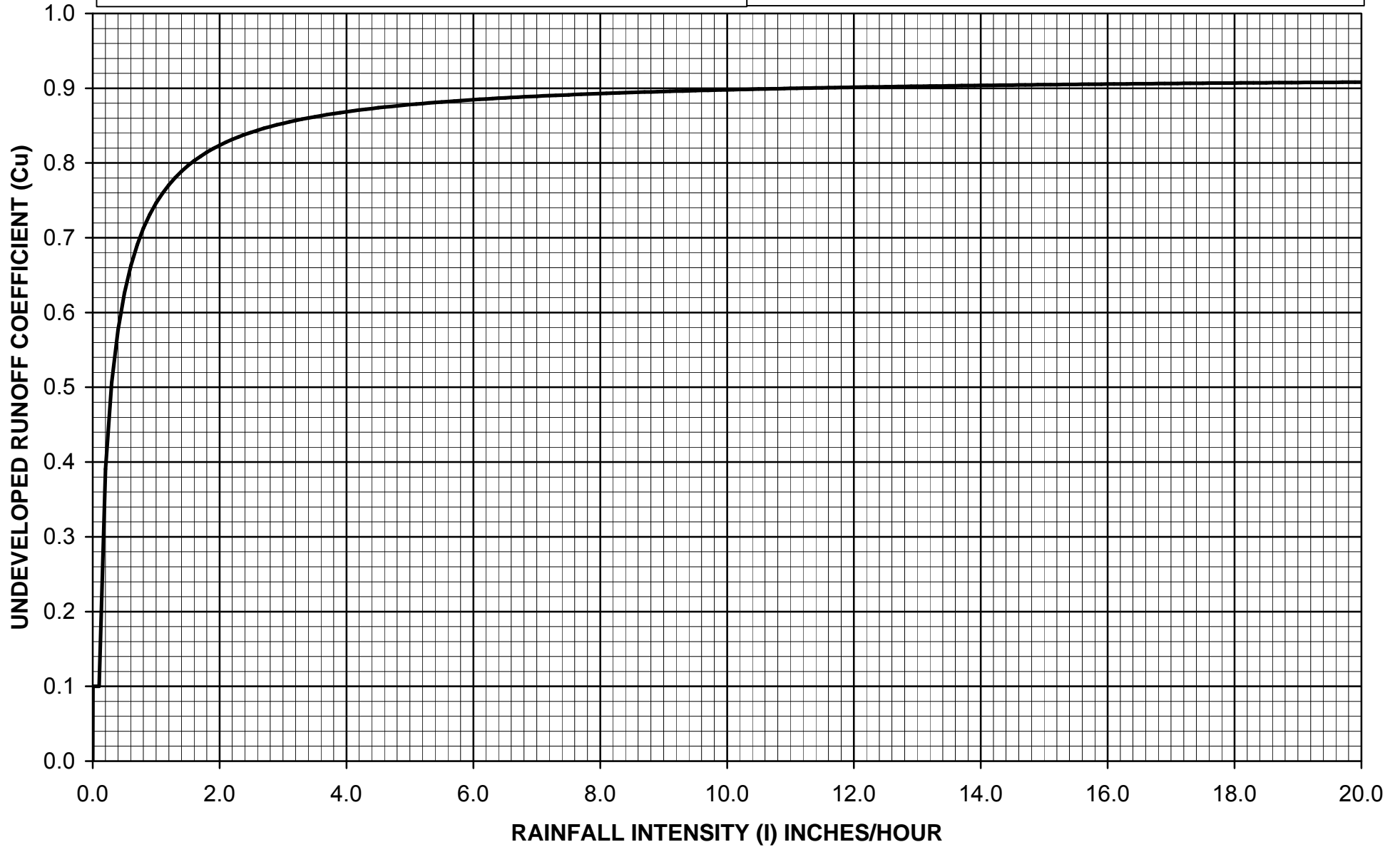

$C_D = (0.9 * IMP) + (1.0 - IMP) * C_U$
 Where: C_D = Developed Runoff Coefficient
 IMP = Proportion Impervious
 C_U = Undeveloped runoff coefficient



Los Angeles County Department of Public Works

**RUNOFF COEFFICIENT CURVE
SOIL TYPE NO. 111**

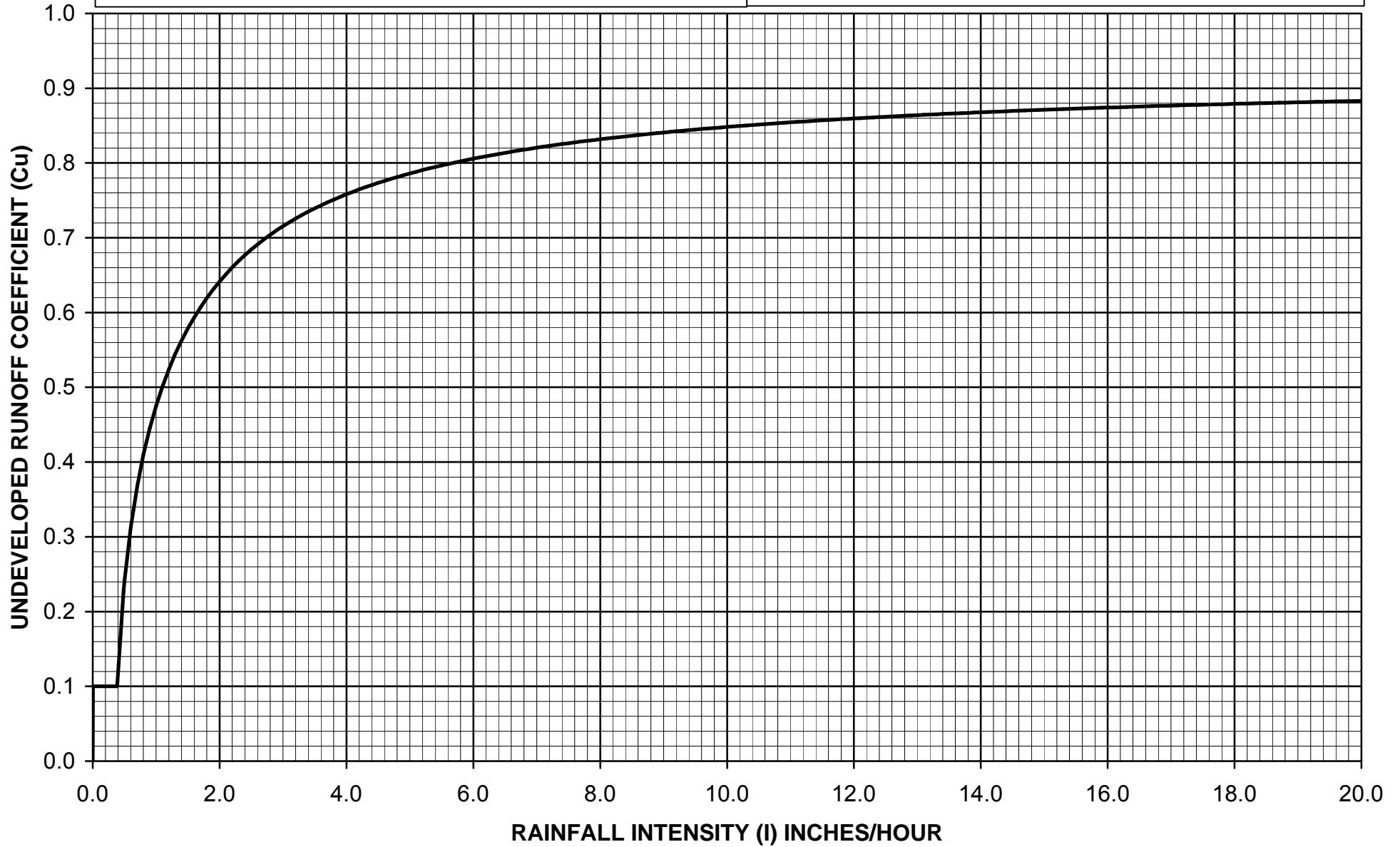

$C_D = (0.9 * IMP) + (1.0 - IMP) * C_U$
 Where: C_D = Developed Runoff Coefficient
 IMP = Proportion Impervious
 C_U = Undeveloped runoff coefficient



Los Angeles County Department of Public Works

RUNOFF COEFFICIENT CURVE
SOIL TYPE NO. 112

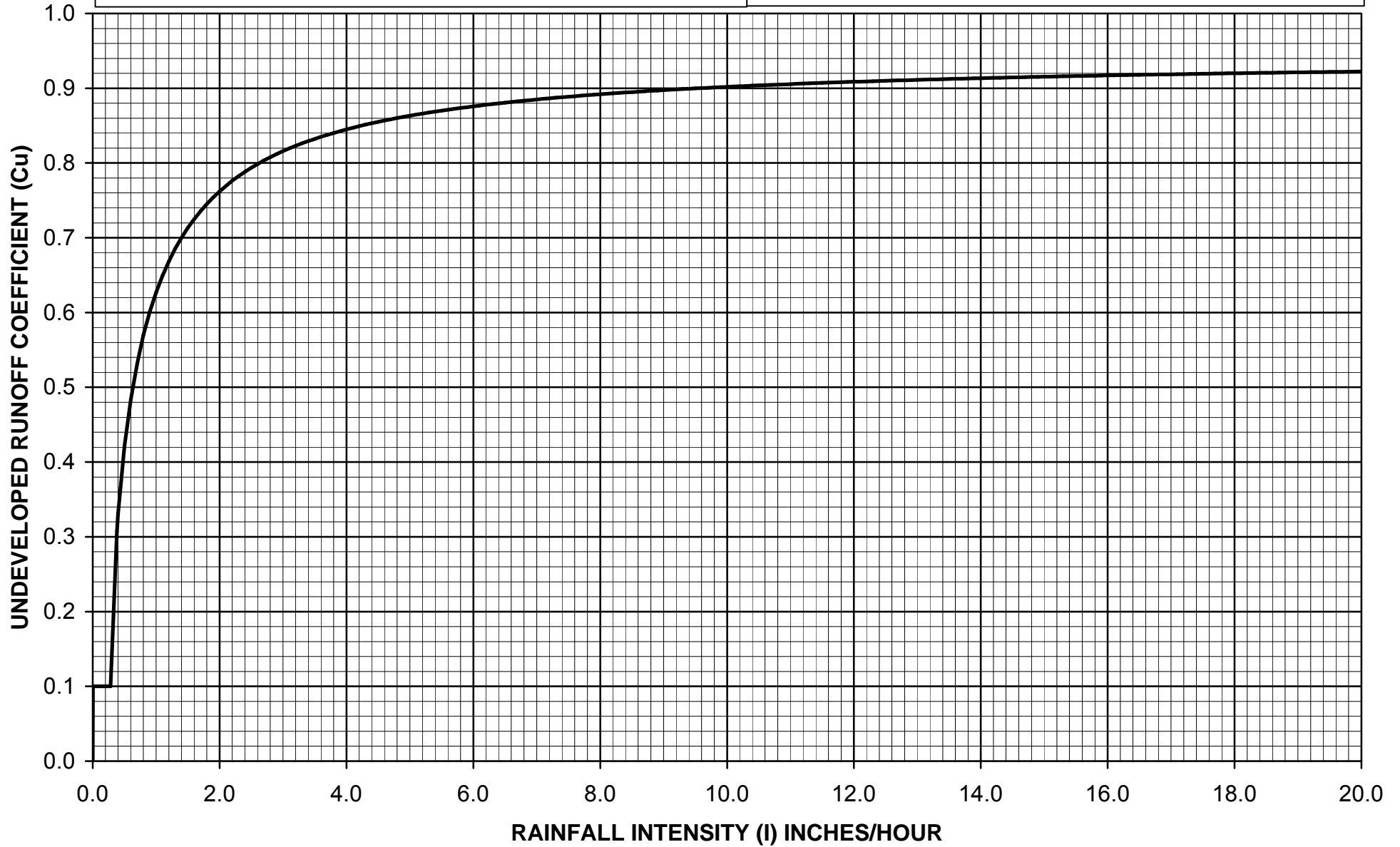

$C_D = (0.9 * IMP) + (1.0 - IMP) * C_U$
 Where: C_D = Developed Runoff Coefficient
 IMP = Proportion Impervious
 C_U = Undeveloped runoff coefficient



Los Angeles County Department of Public Works

RUNOFF COEFFICIENT CURVE
SOIL TYPE NO. 113

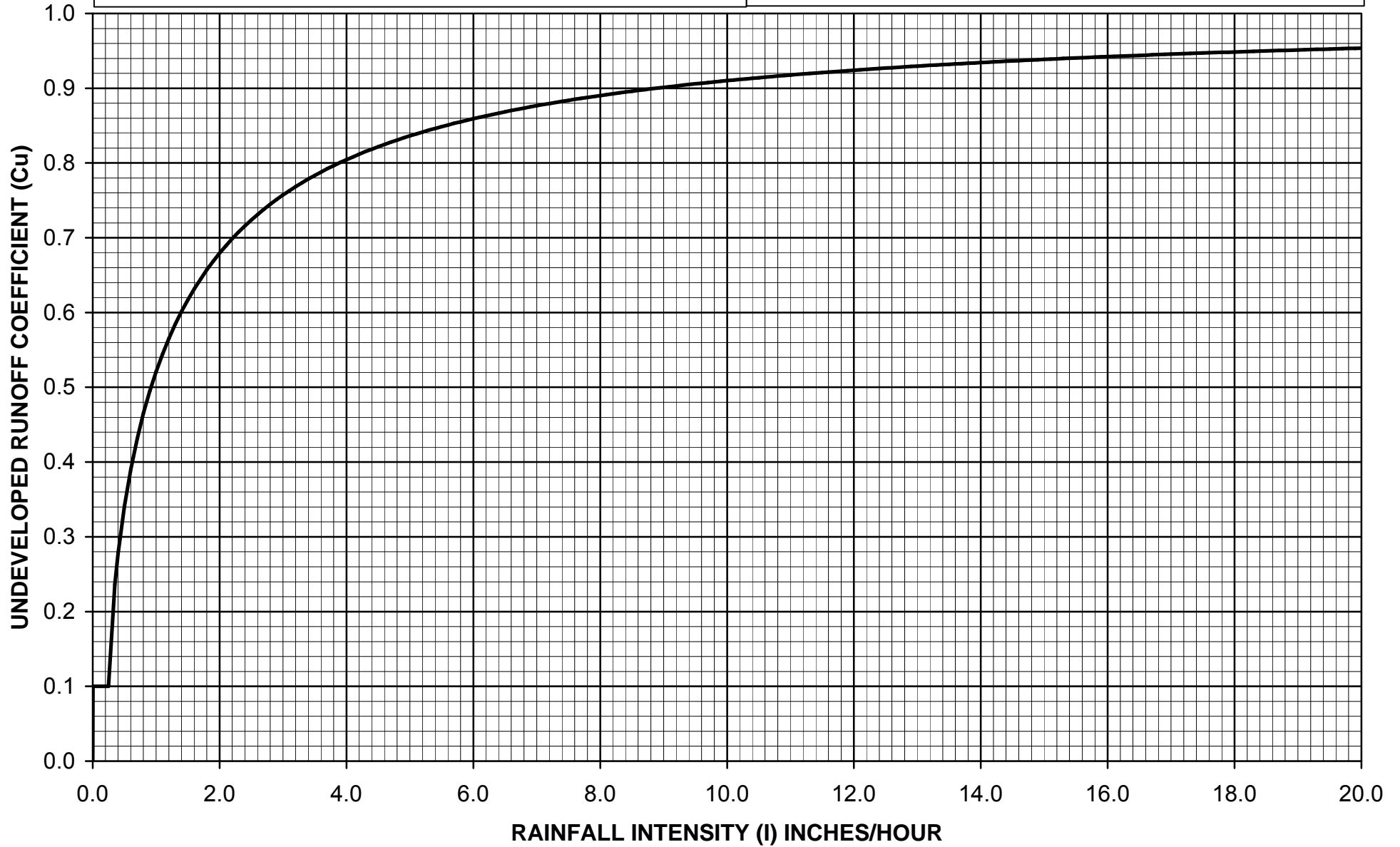

$C_D = (0.9 * IMP) + (1.0 - IMP) * C_U$
Where: C_D = Developed Runoff Coefficient
IMP = Proportion Impervious
 C_U = Undeveloped runoff coefficient



Los Angeles County Department of Public Works

RUNOFF COEFFICIENT CURVE
SOIL TYPE NO. 114

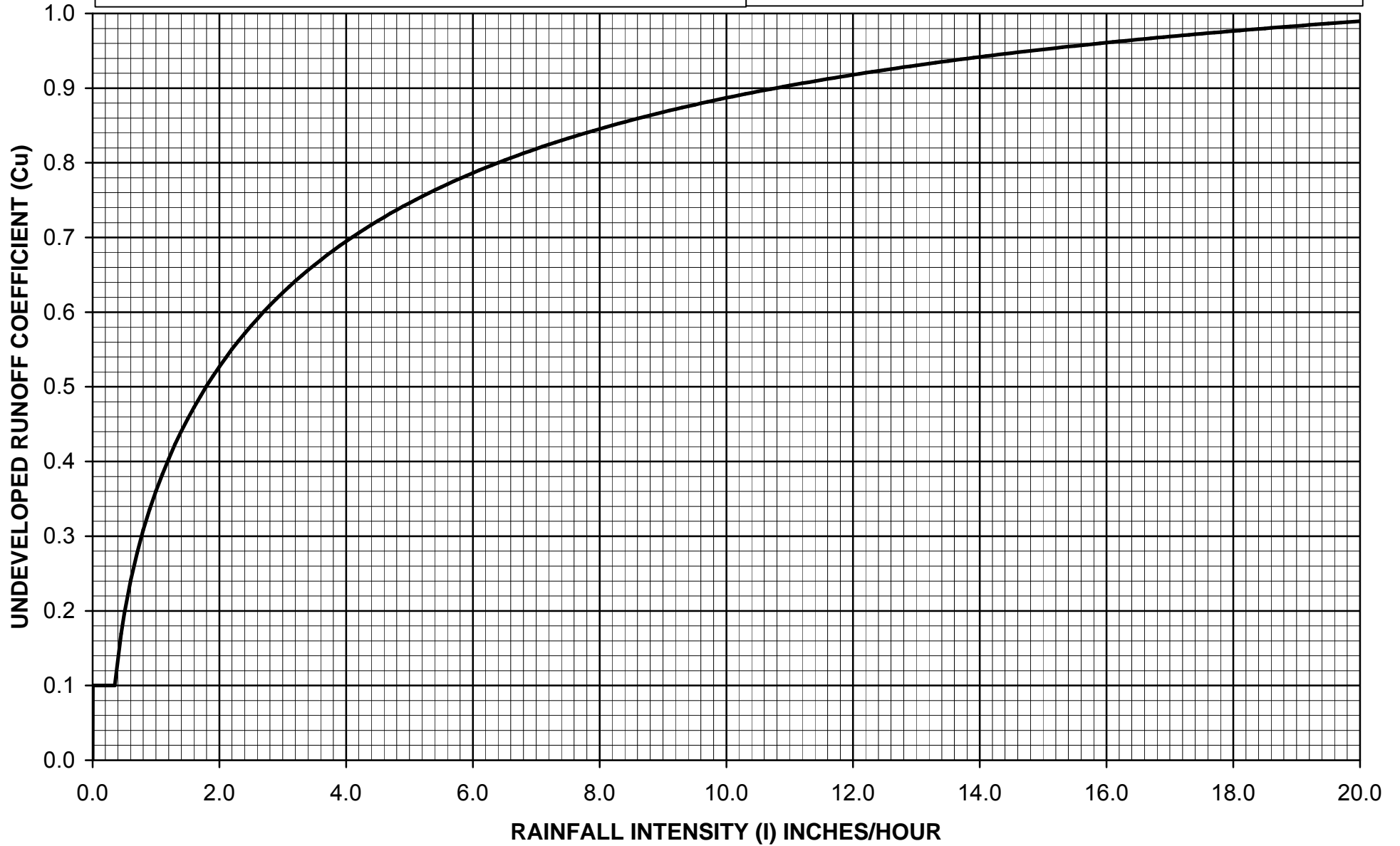

$C_D = (0.9 * IMP) + (1.0 - IMP) * C_U$
 Where: C_D = Developed Runoff Coefficient
 IMP = Proportion Impervious
 C_U = Undeveloped runoff coefficient



Los Angeles County Department of Public Works

RUNOFF COEFFICIENT CURVE
SOIL TYPE NO. 115

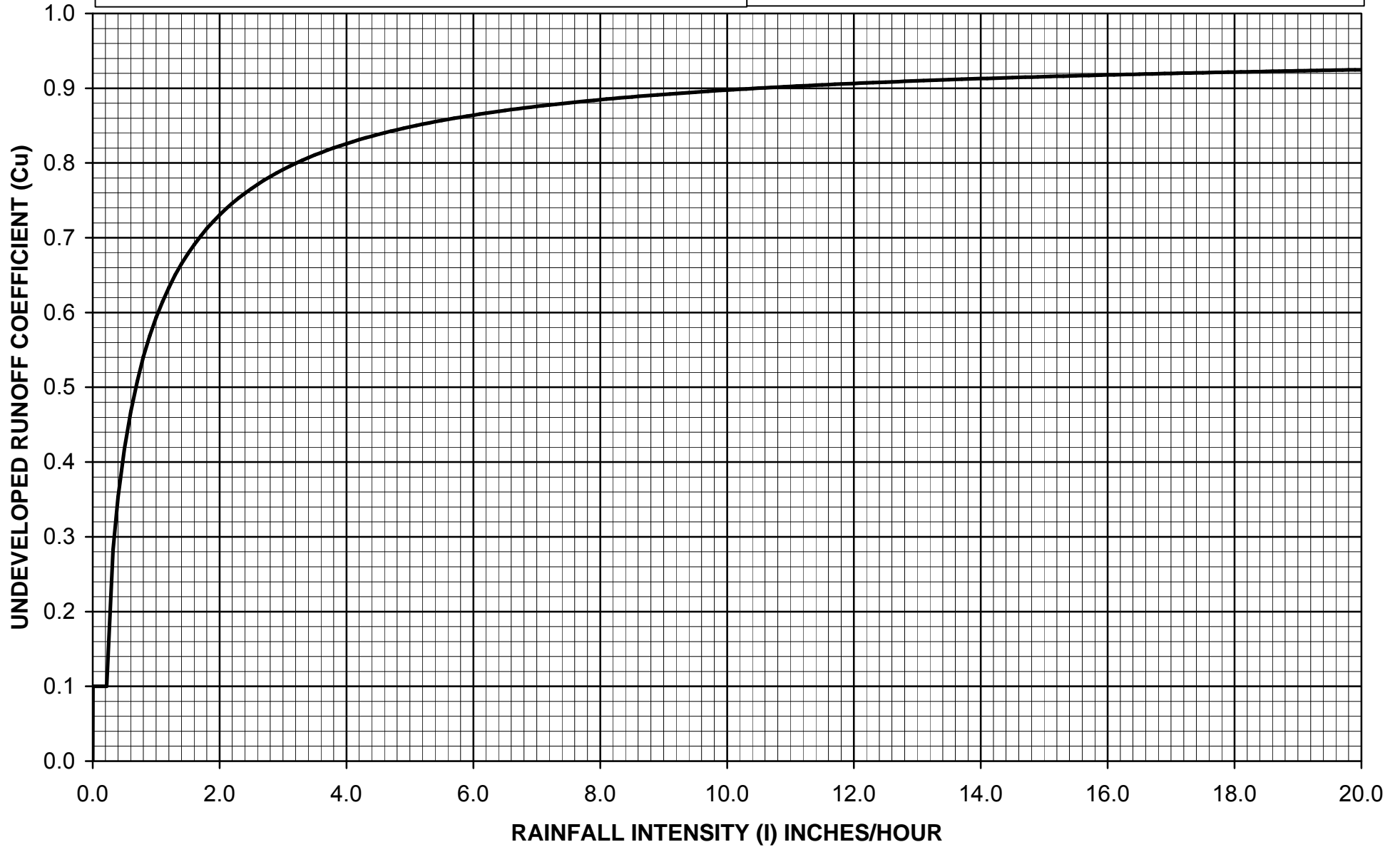

$C_D = (0.9 * IMP) + (1.0 - IMP) * C_U$
 Where: C_D = Developed Runoff Coefficient
 IMP = Proportion Impervious
 C_U = Undeveloped runoff coefficient



Los Angeles County Department of Public Works

**RUNOFF COEFFICIENT CURVE
SOIL TYPE NO. 116**

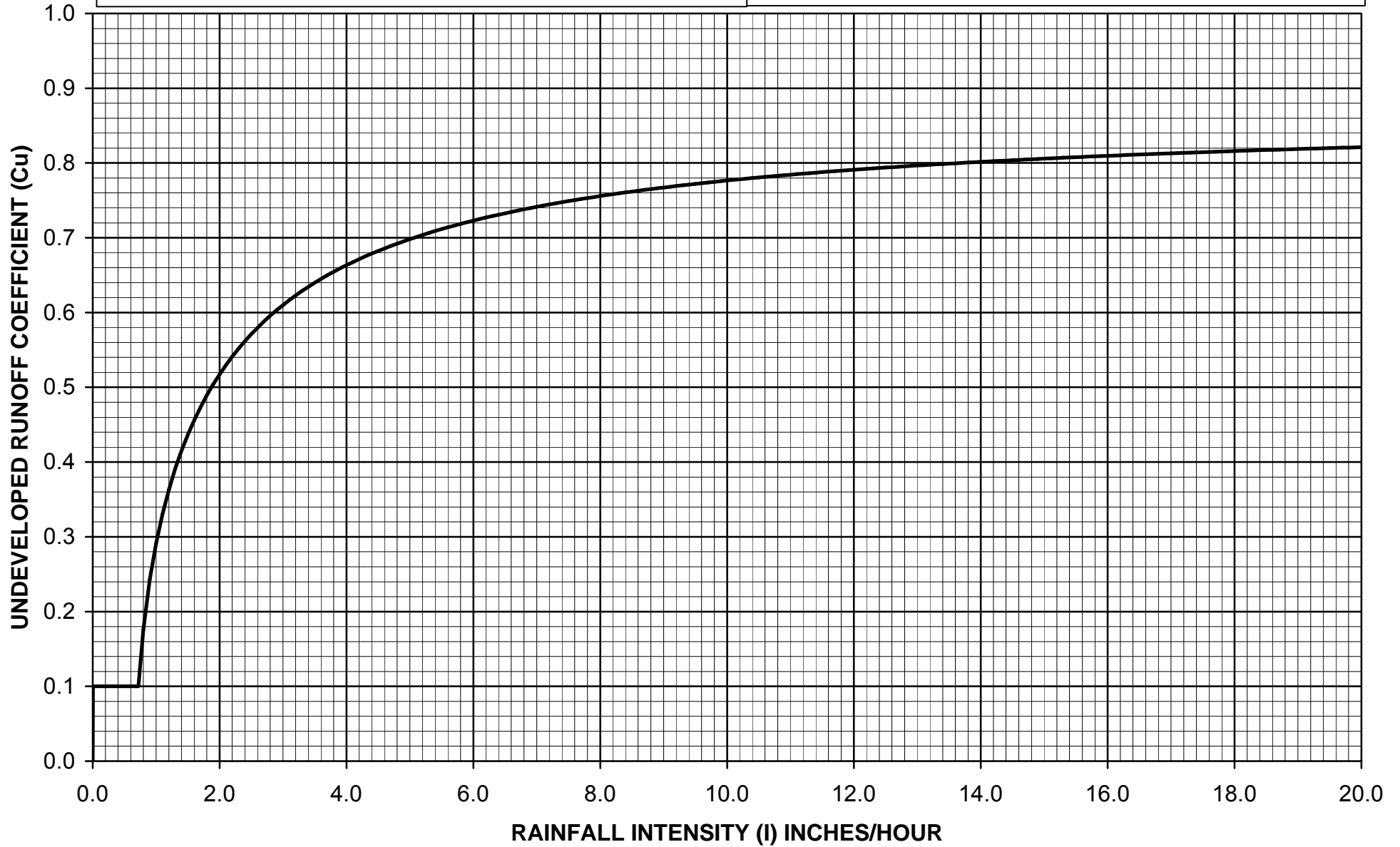

$C_D = (0.9 * IMP) + (1.0 - IMP) * C_U$
Where: C_D = Developed Runoff Coefficient
IMP = Proportion Impervious
 C_U = Undeveloped runoff coefficient



Los Angeles County Department of Public Works

RUNOFF COEFFICIENT CURVE
SOIL TYPE NO. 117

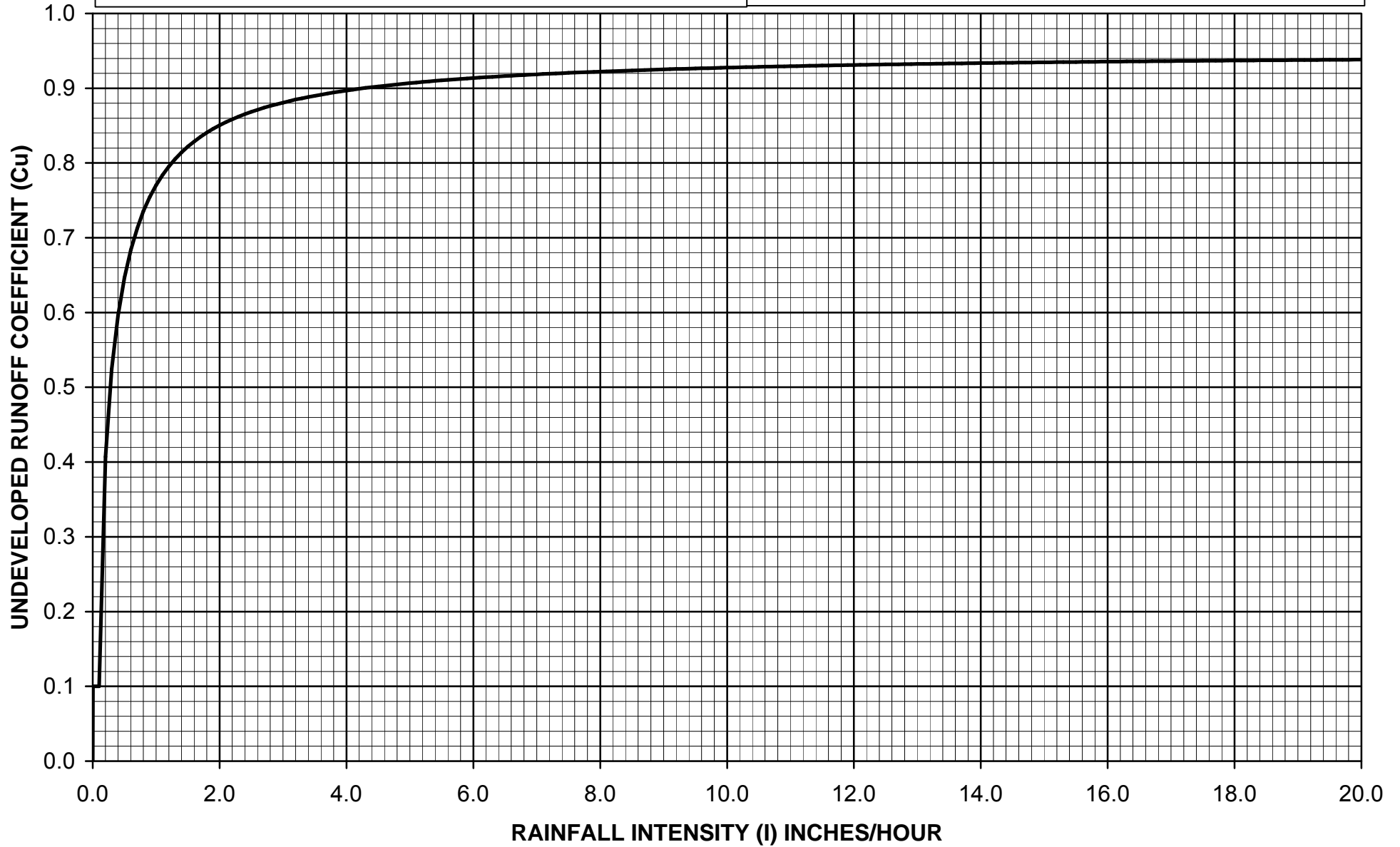

$C_D = (0.9 * IMP) + (1.0 - IMP) * C_U$
 Where: C_D = Developed Runoff Coefficient
 IMP = Proportion Impervious
 C_U = Undeveloped runoff coefficient



Los Angeles County Department of Public Works

**RUNOFF COEFFICIENT CURVE
SOIL TYPE NO. 118**

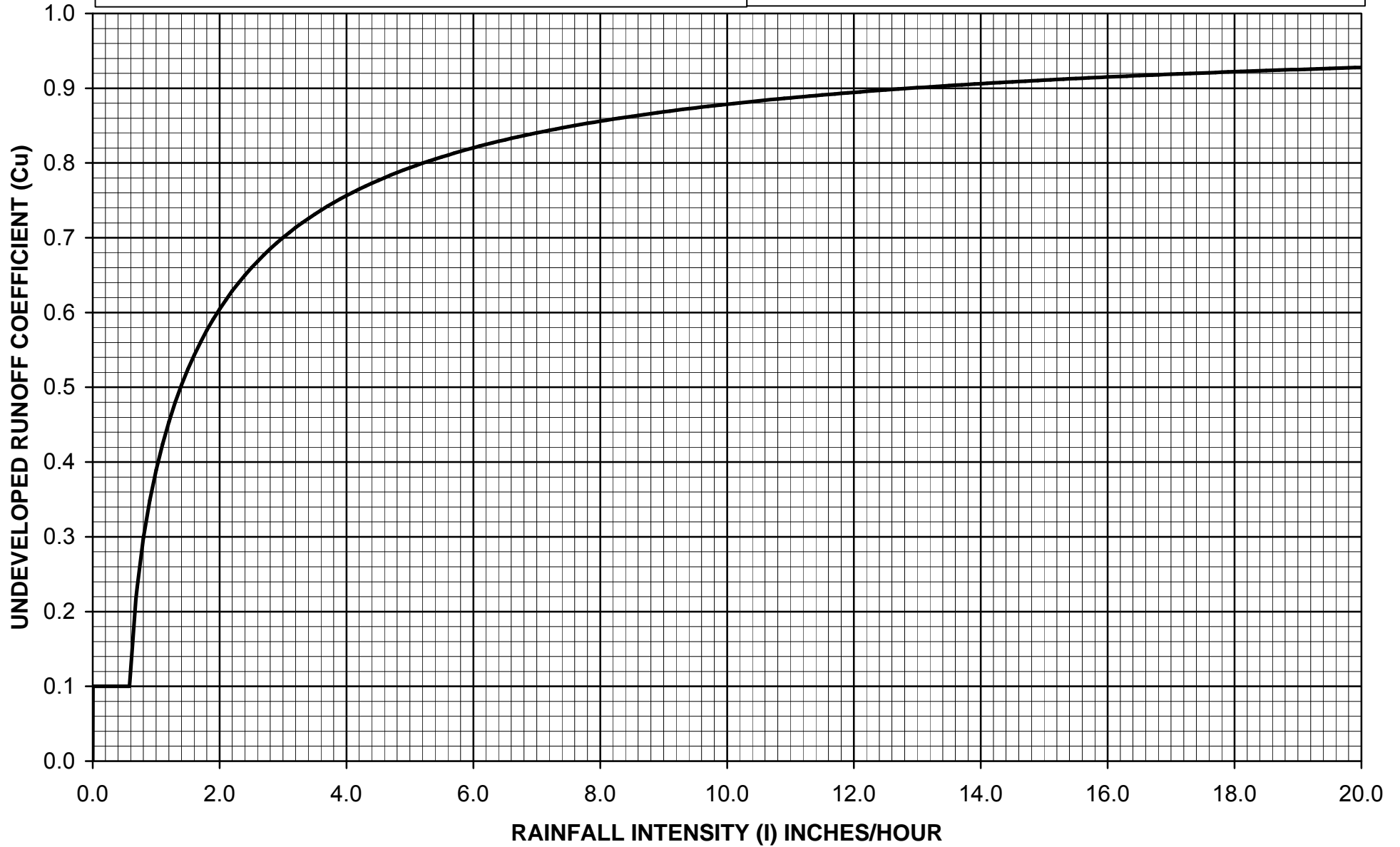

$C_D = (0.9 * IMP) + (1.0 - IMP) * C_U$
 Where: C_D = Developed Runoff Coefficient
 IMP = Proportion Impervious
 C_U = Undeveloped runoff coefficient



Los Angeles County Department of Public Works

RUNOFF COEFFICIENT CURVE
SOIL TYPE NO. 119

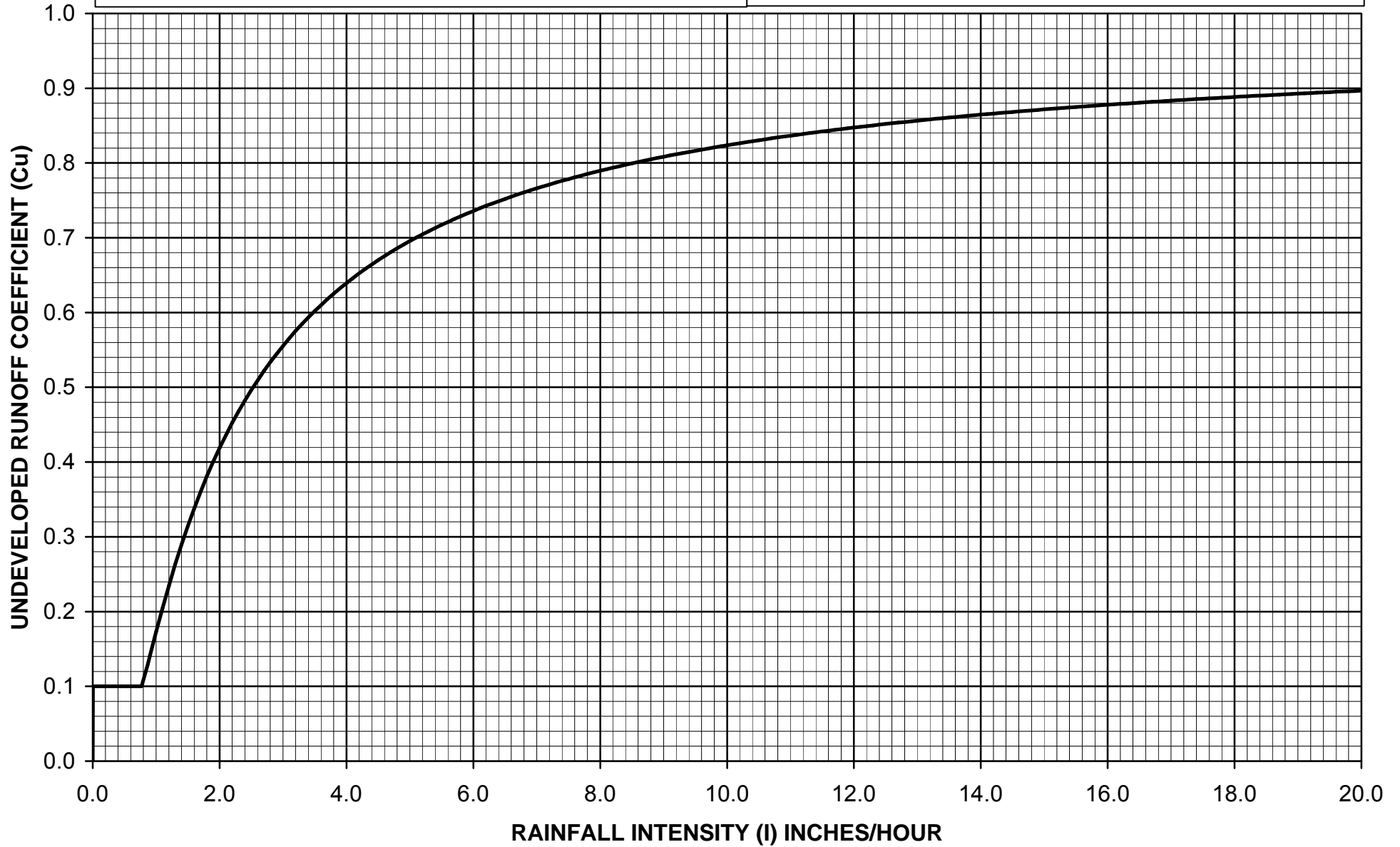

$$C_D = (0.9 * IMP) + (1.0 - IMP) * C_U$$

Where: C_D = Developed Runoff Coefficient
 IMP = Proportion Impervious
 C_U = Undeveloped runoff coefficient



Los Angeles County Department of Public Works

RUNOFF COEFFICIENT CURVE
SOIL TYPE NO. 120

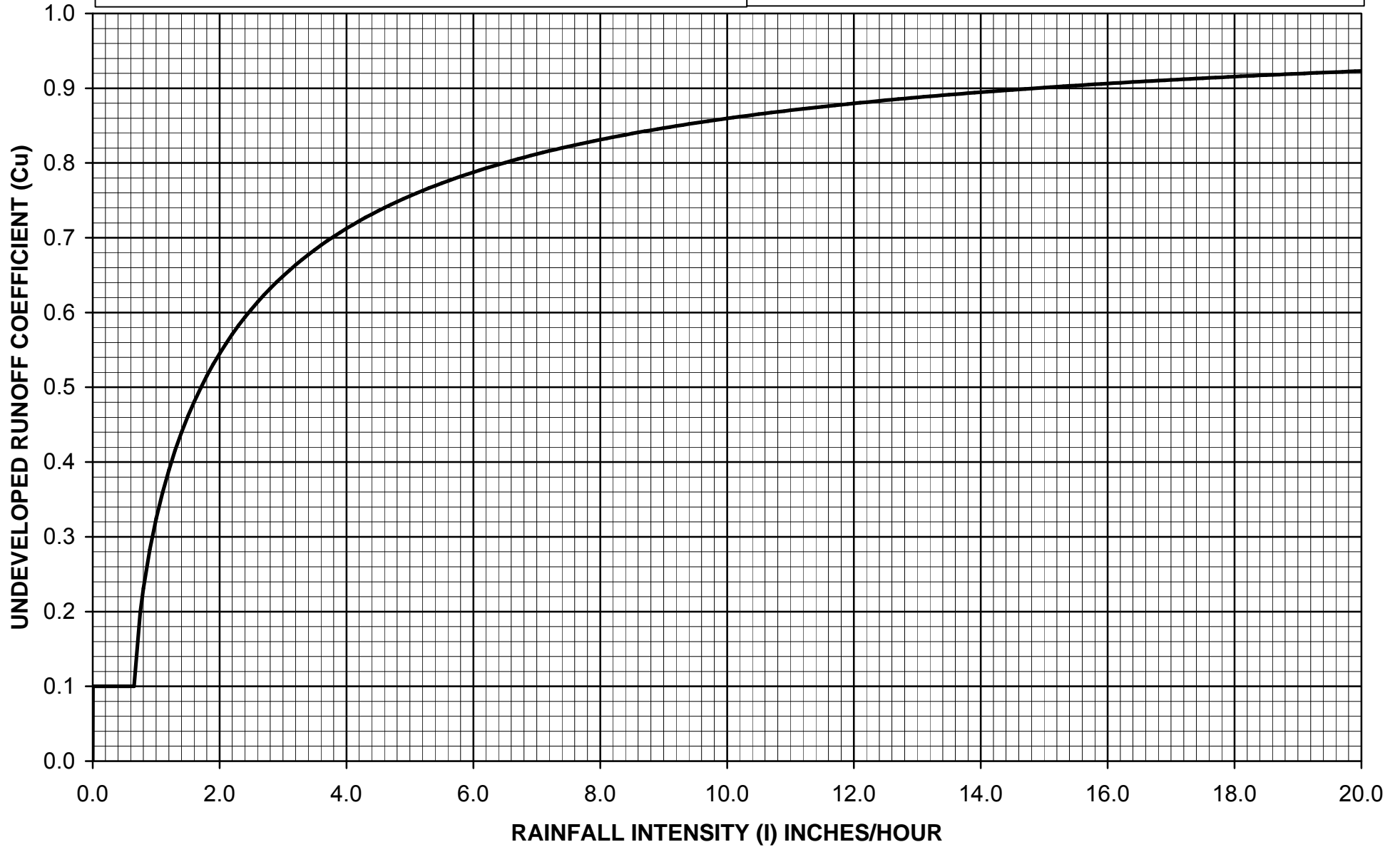

$C_D = (0.9 * IMP) + (1.0 - IMP) * C_U$
Where: C_D = Developed Runoff Coefficient
IMP = Proportion Impervious
 C_U = Undeveloped runoff coefficient



Los Angeles County Department of Public Works

RUNOFF COEFFICIENT CURVE
SOIL TYPE NO. 121

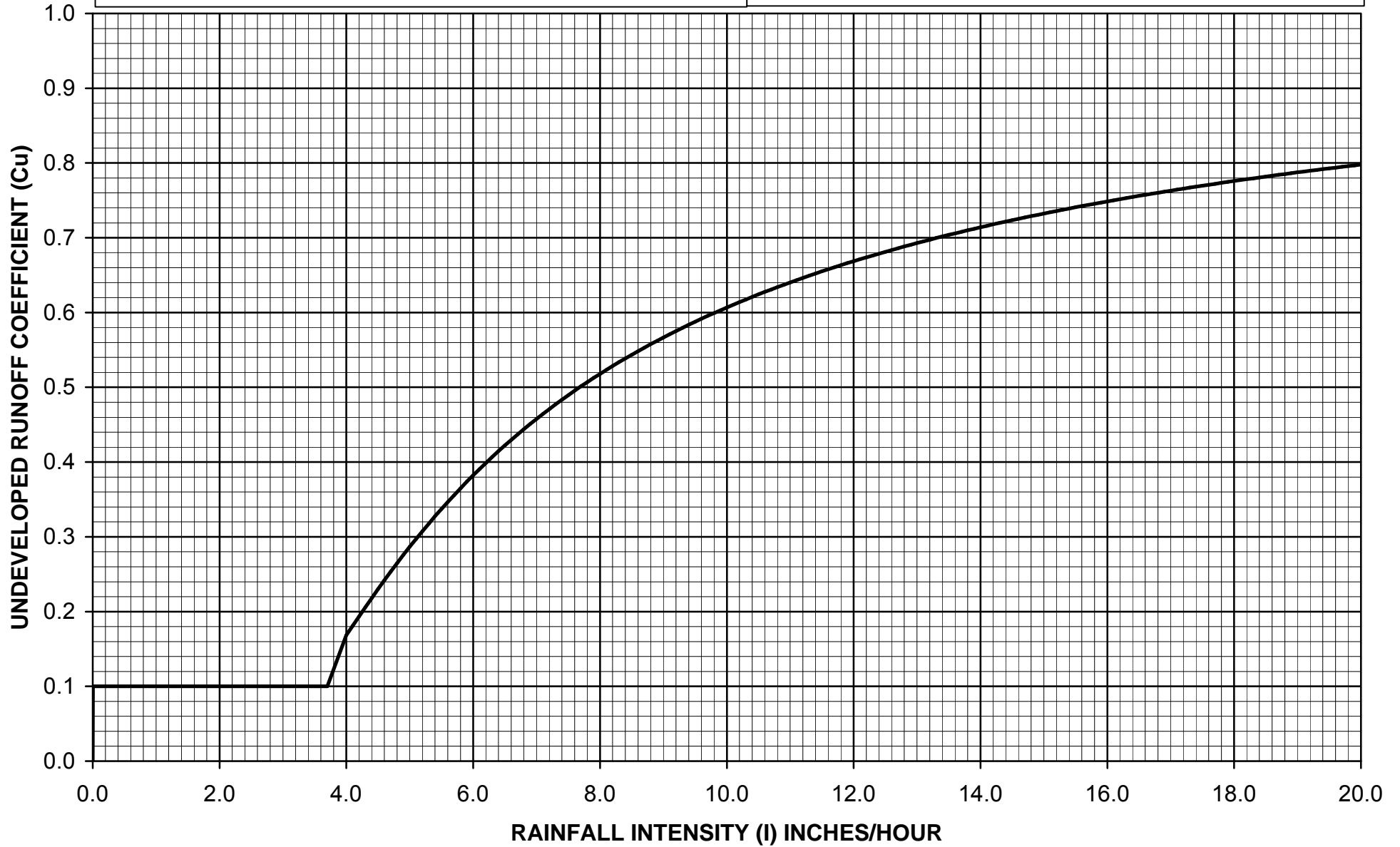

$C_D = (0.9 * IMP) + (1.0 - IMP) * C_U$
 Where: C_D = Developed Runoff Coefficient
 IMP = Proportion Impervious
 C_U = Undeveloped runoff coefficient



Los Angeles County Department of Public Works

**RUNOFF COEFFICIENT CURVE
SOIL TYPE NO. 122**

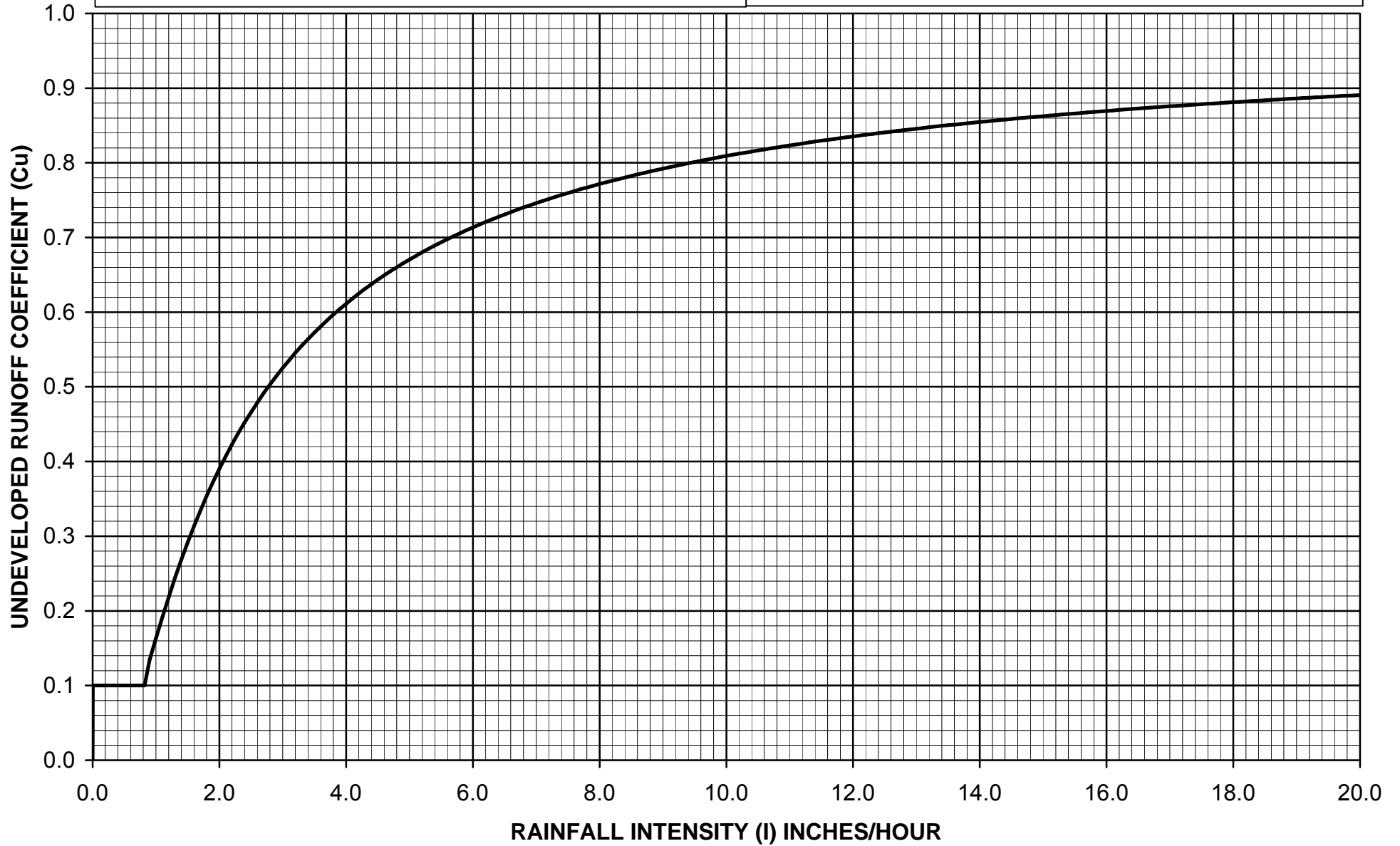

$C_D = (0.9 * IMP) + (1.0 - IMP) * C_U$
 Where: C_D = Developed Runoff Coefficient
 IMP = Proportion Impervious
 C_U = Undeveloped runoff coefficient



Los Angeles County Department of Public Works

RUNOFF COEFFICIENT CURVE
SOIL TYPE NO. 123

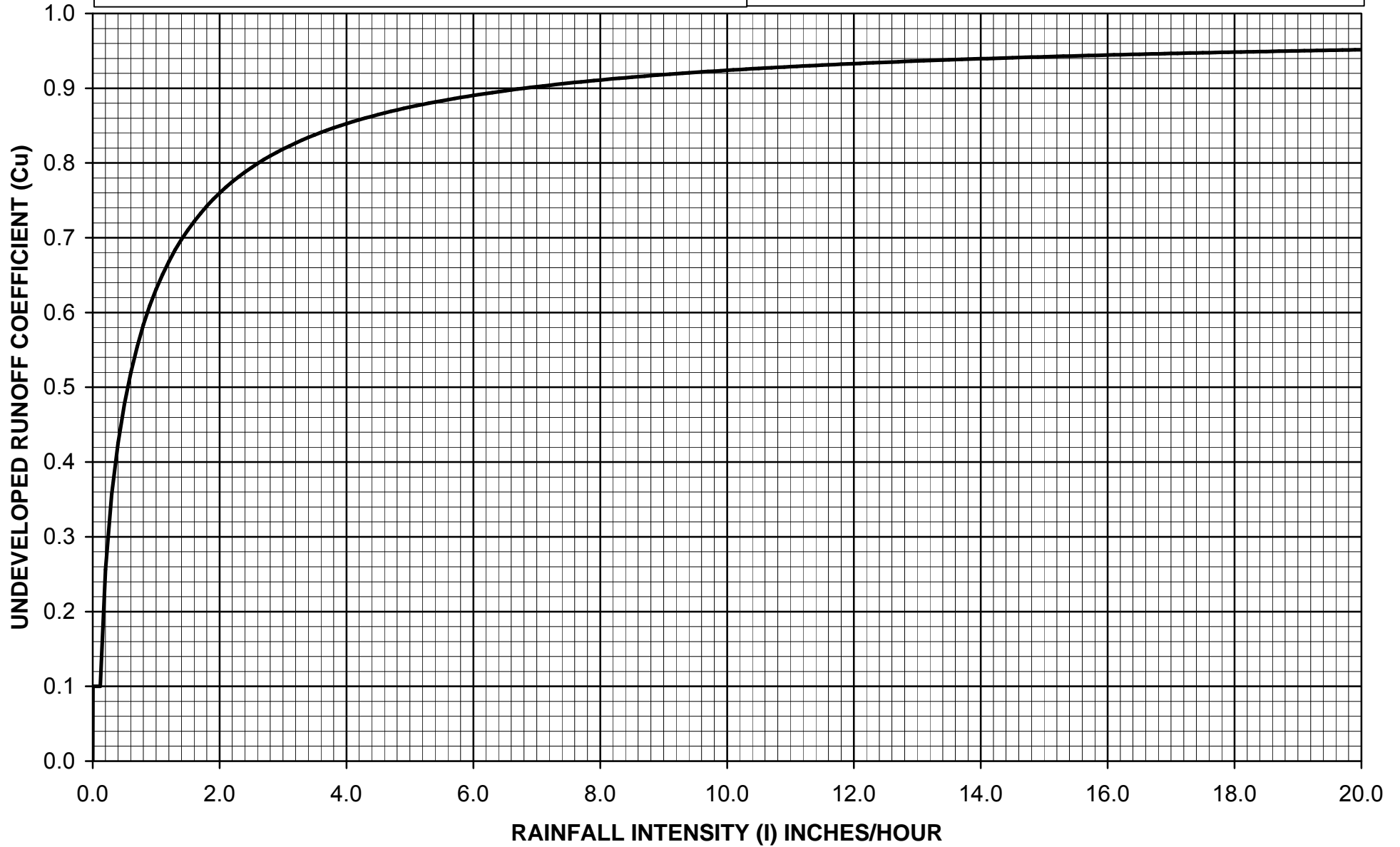

$C_D = (0.9 * IMP) + (1.0 - IMP) * C_U$
 Where: C_D = Developed Runoff Coefficient
 IMP = Proportion Impervious
 C_U = Undeveloped runoff coefficient



Los Angeles County Department of Public Works

**RUNOFF COEFFICIENT CURVE
SOIL TYPE NO. 124**

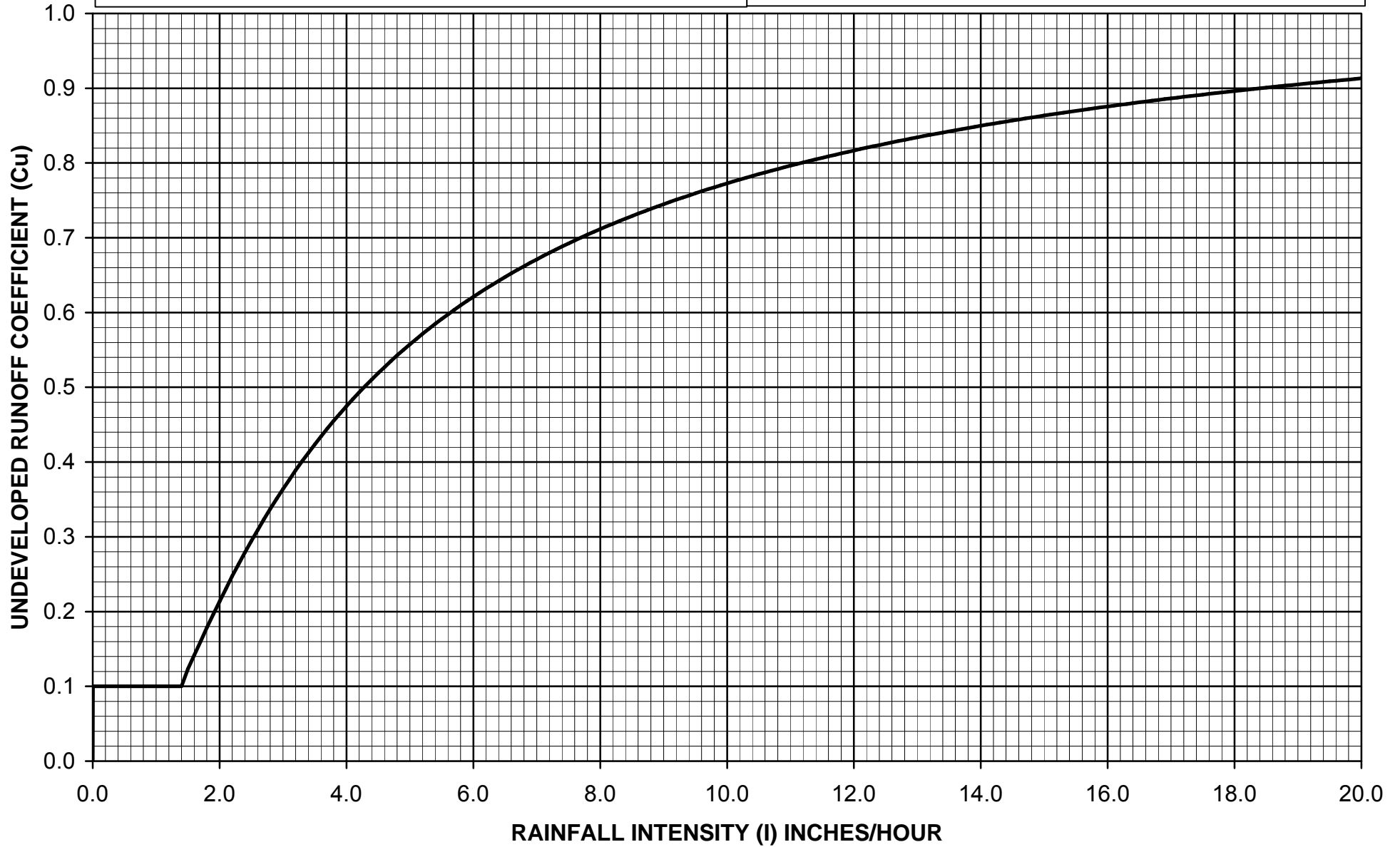

$C_D = (0.9 * IMP) + (1.0 - IMP) * C_U$
 Where: C_D = Developed Runoff Coefficient
 IMP = Proportion Impervious
 C_U = Undeveloped runoff coefficient



Los Angeles County Department of Public Works

RUNOFF COEFFICIENT CURVE
SOIL TYPE NO. 125

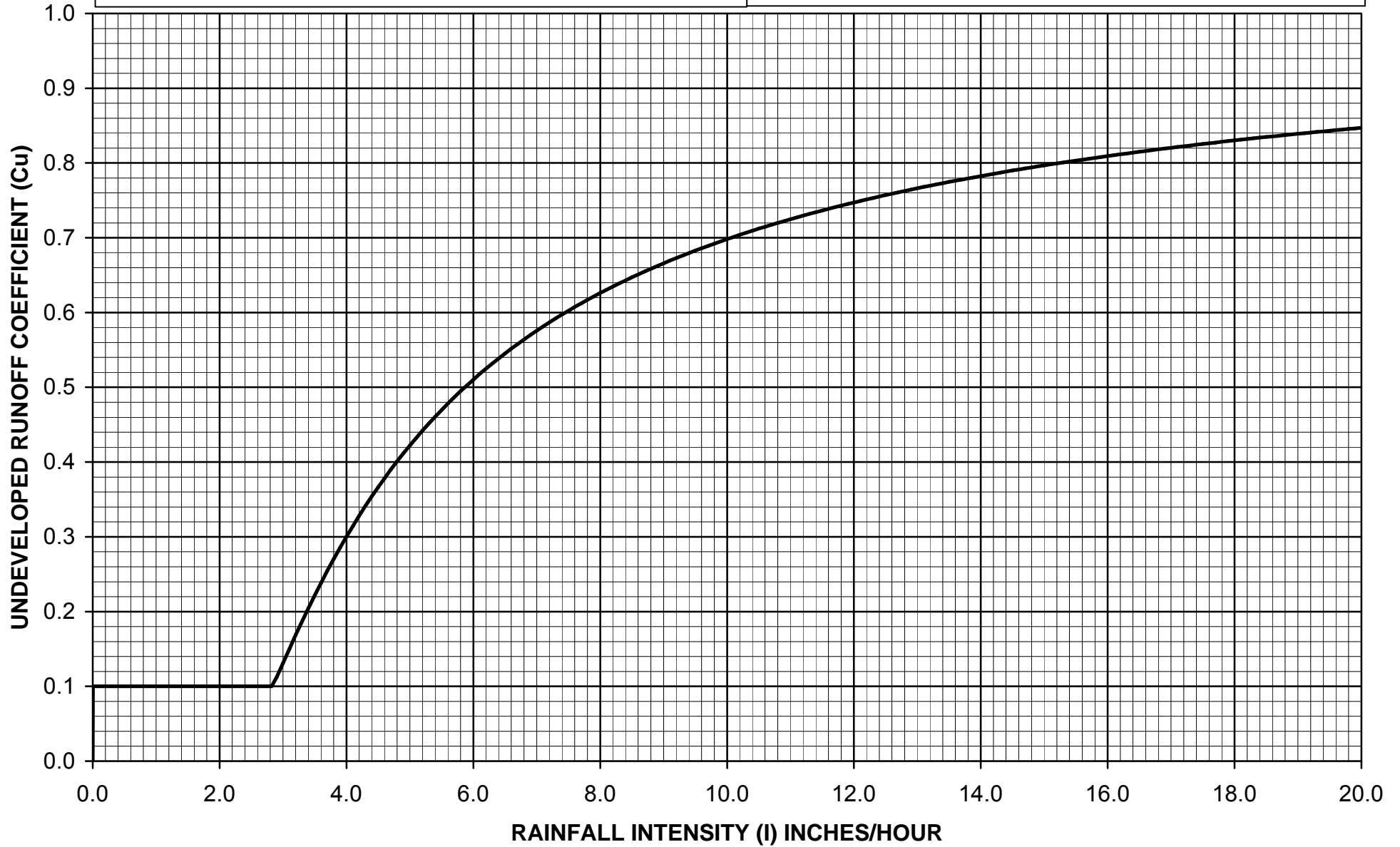

$C_D = (0.9 * IMP) + (1.0 - IMP) * C_U$
 Where: C_D = Developed Runoff Coefficient
 IMP = Proportion Impervious
 C_U = Undeveloped runoff coefficient



Los Angeles County Department of Public Works

RUNOFF COEFFICIENT CURVE
SOIL TYPE NO. 126

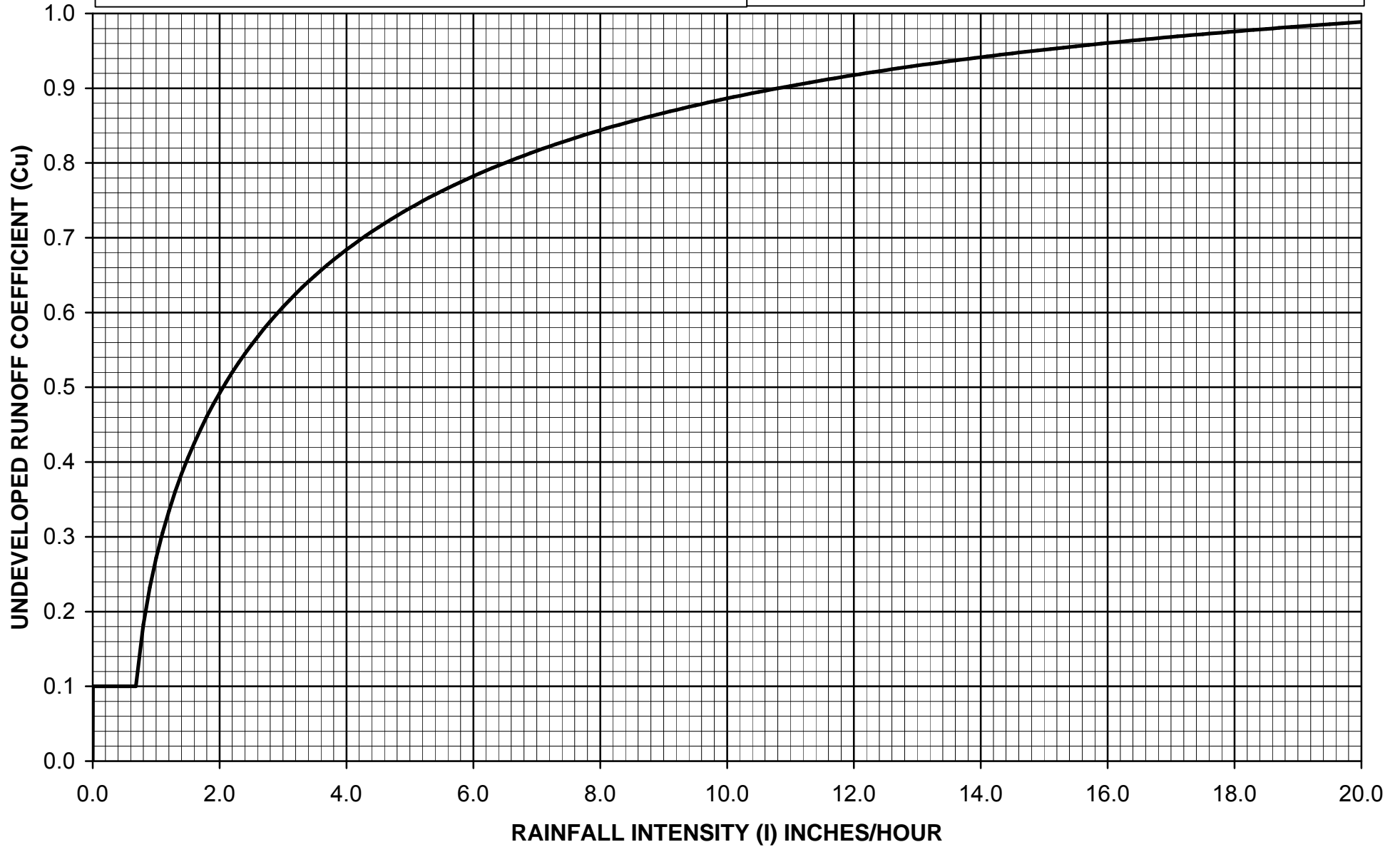

$$C_D = (0.9 * IMP) + (1.0 - IMP) * C_U$$

Where: C_D = Developed Runoff Coefficient
 IMP = Proportion Impervious
 C_U = Undeveloped runoff coefficient



Los Angeles County Department of Public Works

RUNOFF COEFFICIENT CURVE
SOIL TYPE NO. 127

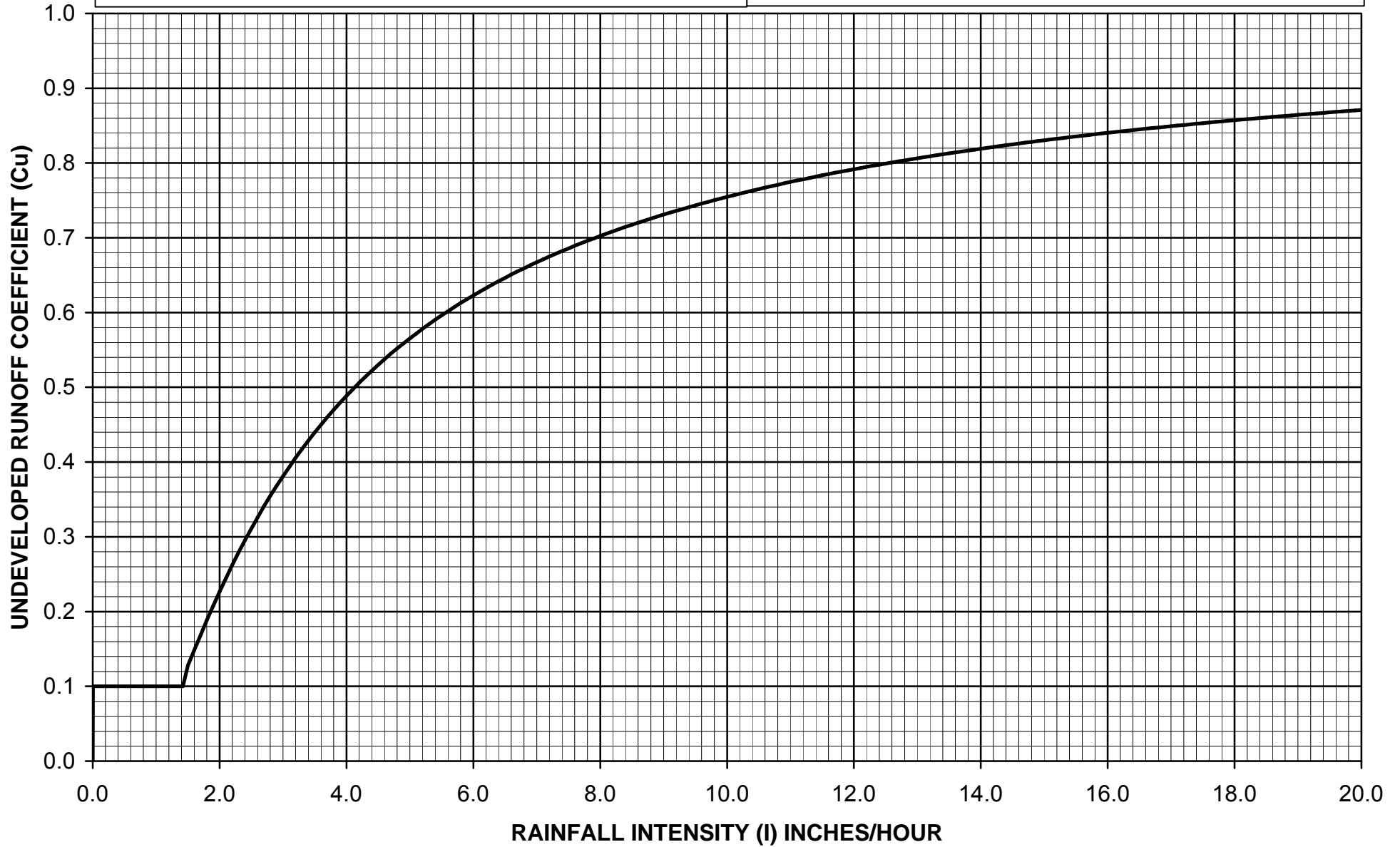

$C_D = (0.9 * IMP) + (1.0 - IMP) * C_U$
 Where: C_D = Developed Runoff Coefficient
 IMP = Proportion Impervious
 C_U = Undeveloped runoff coefficient



Los Angeles County Department of Public Works

**RUNOFF COEFFICIENT CURVE
SOIL TYPE NO. 128**

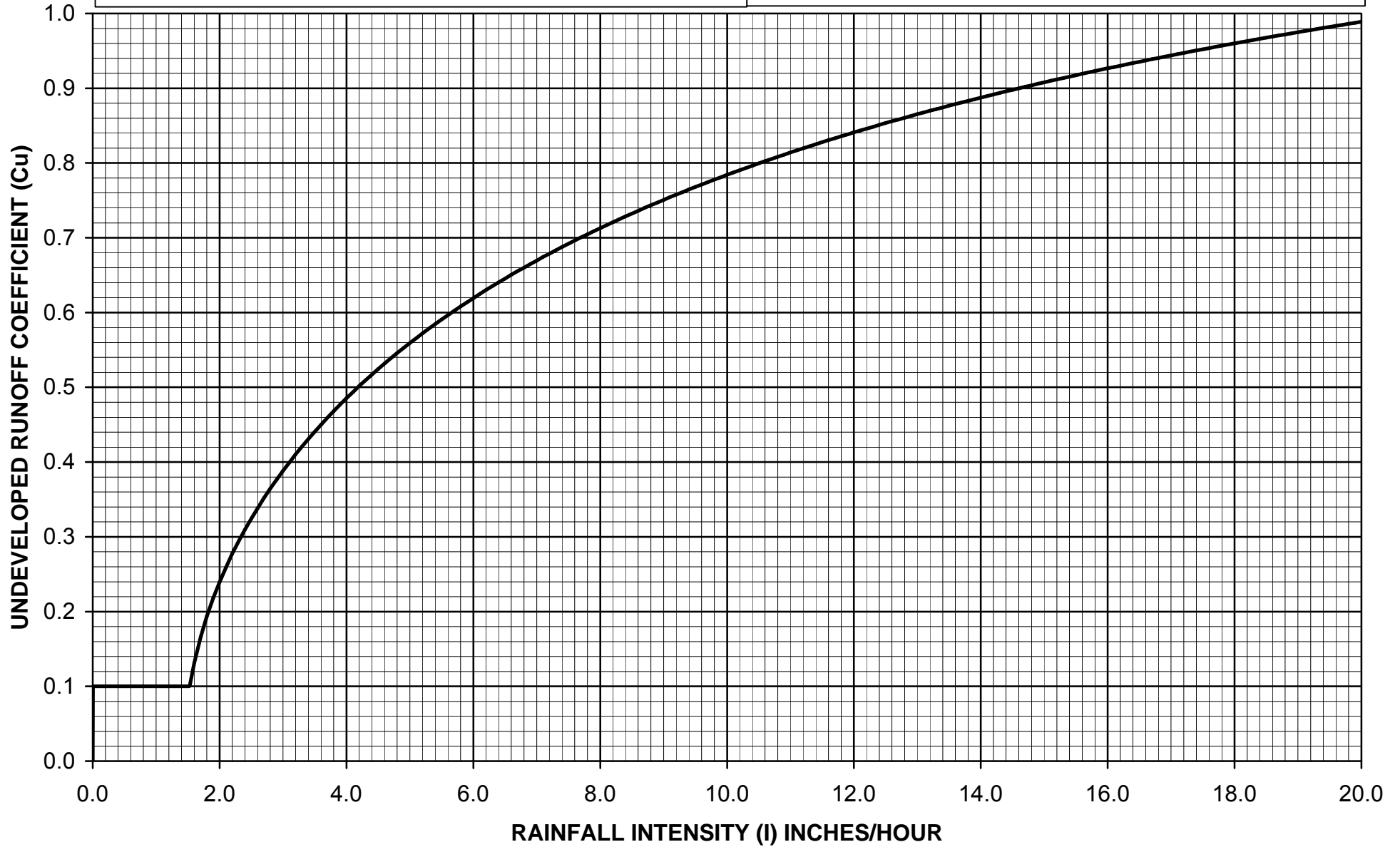

$$C_D = (0.9 * IMP) + (1.0 - IMP) * C_U$$

Where: C_D = Developed Runoff Coefficient
 IMP = Proportion Impervious
 C_U = Undeveloped runoff coefficient



Los Angeles County Department of Public Works

RUNOFF COEFFICIENT CURVE
SOIL TYPE NO. 129

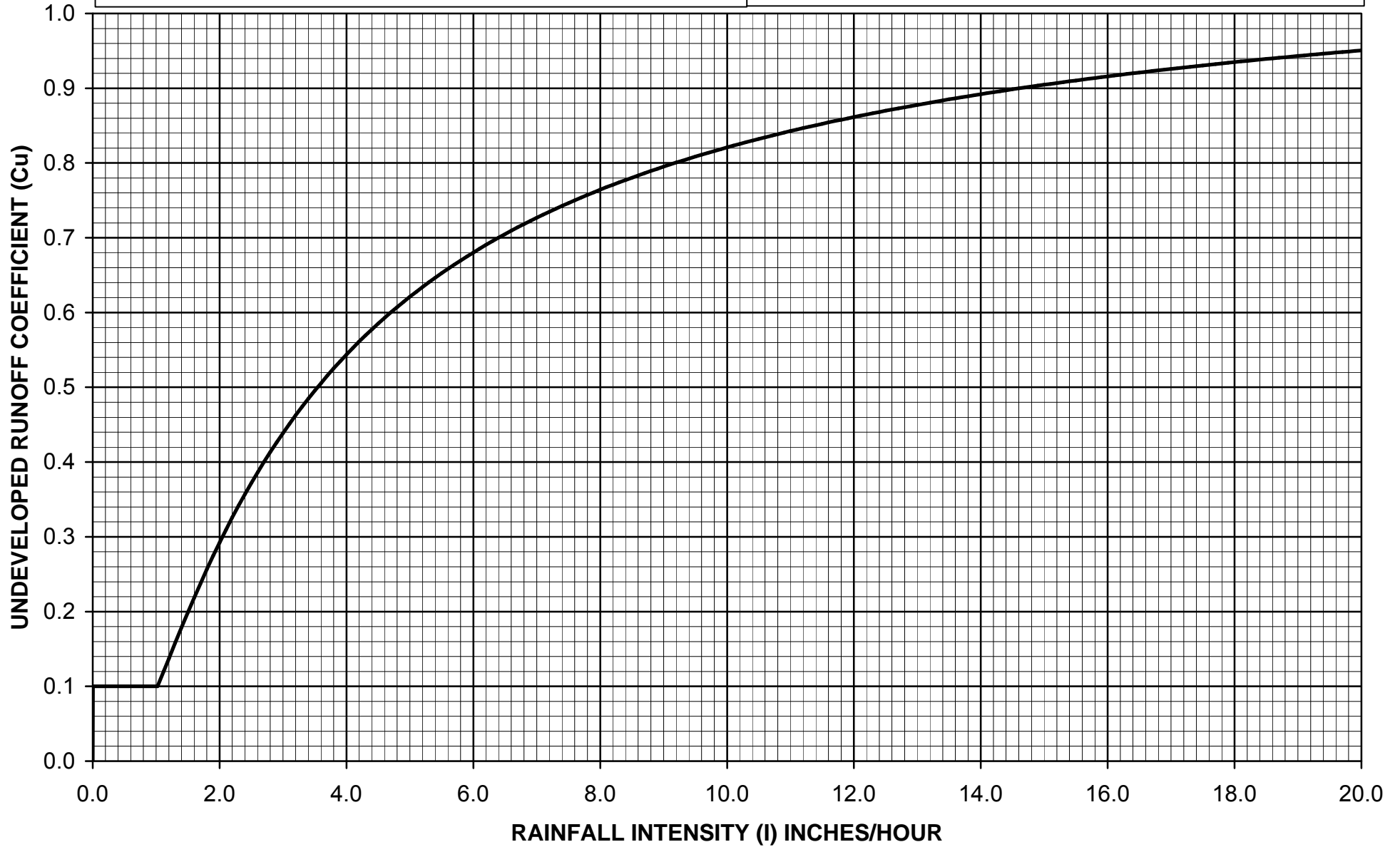

$$C_D = (0.9 * IMP) + (1.0 - IMP) * C_U$$

Where: C_D = Developed Runoff Coefficient
 IMP = Proportion Impervious
 C_U = Undeveloped runoff coefficient



Los Angeles County Department of Public Works

RUNOFF COEFFICIENT CURVE
SOIL TYPE NO. 130

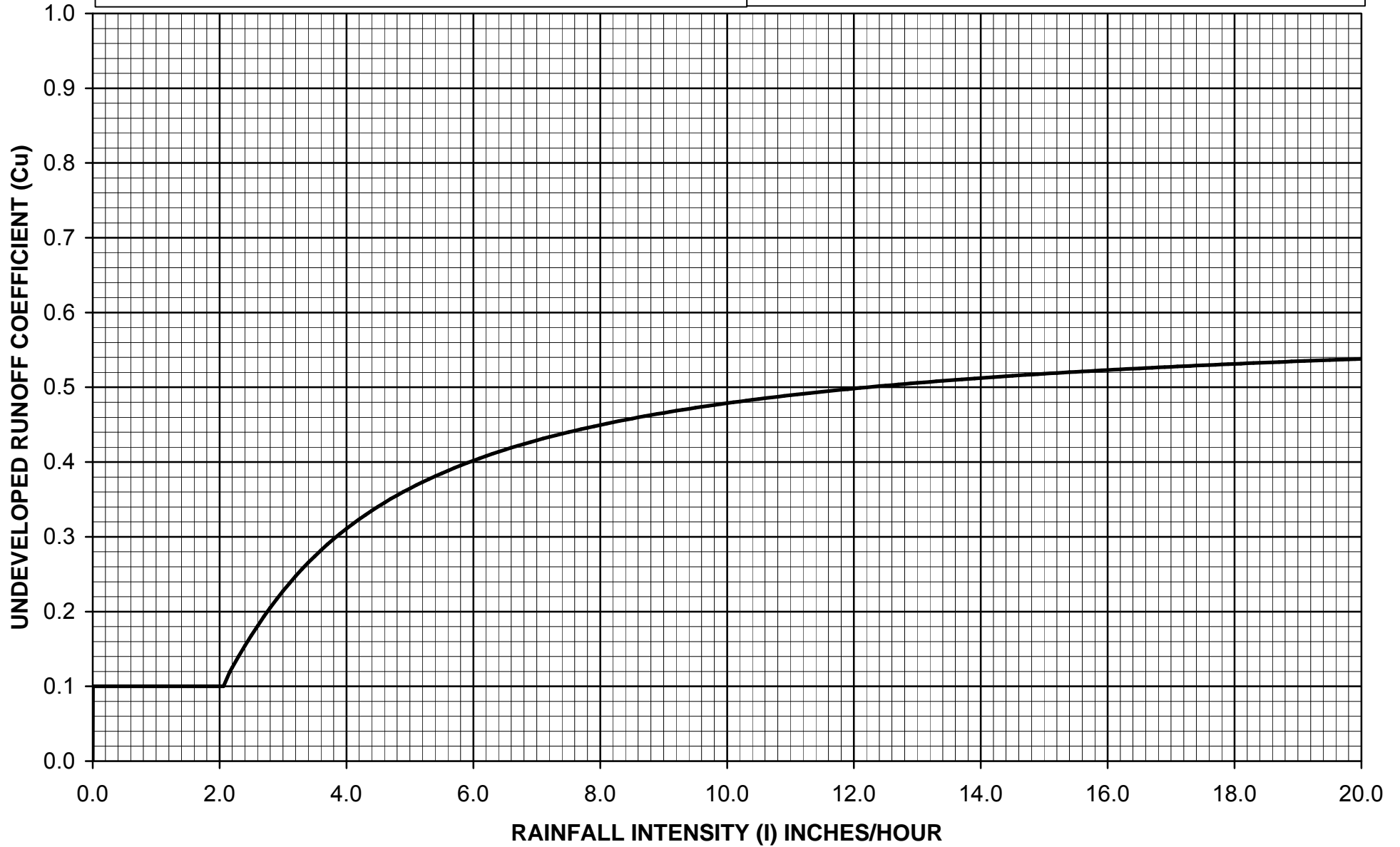

$C_D = (0.9 * IMP) + (1.0 - IMP) * C_U$
 Where: C_D = Developed Runoff Coefficient
 IMP = Proportion Impervious
 C_U = Undeveloped runoff coefficient



Los Angeles County Department of Public Works

RUNOFF COEFFICIENT CURVE
SOIL TYPE NO. 131

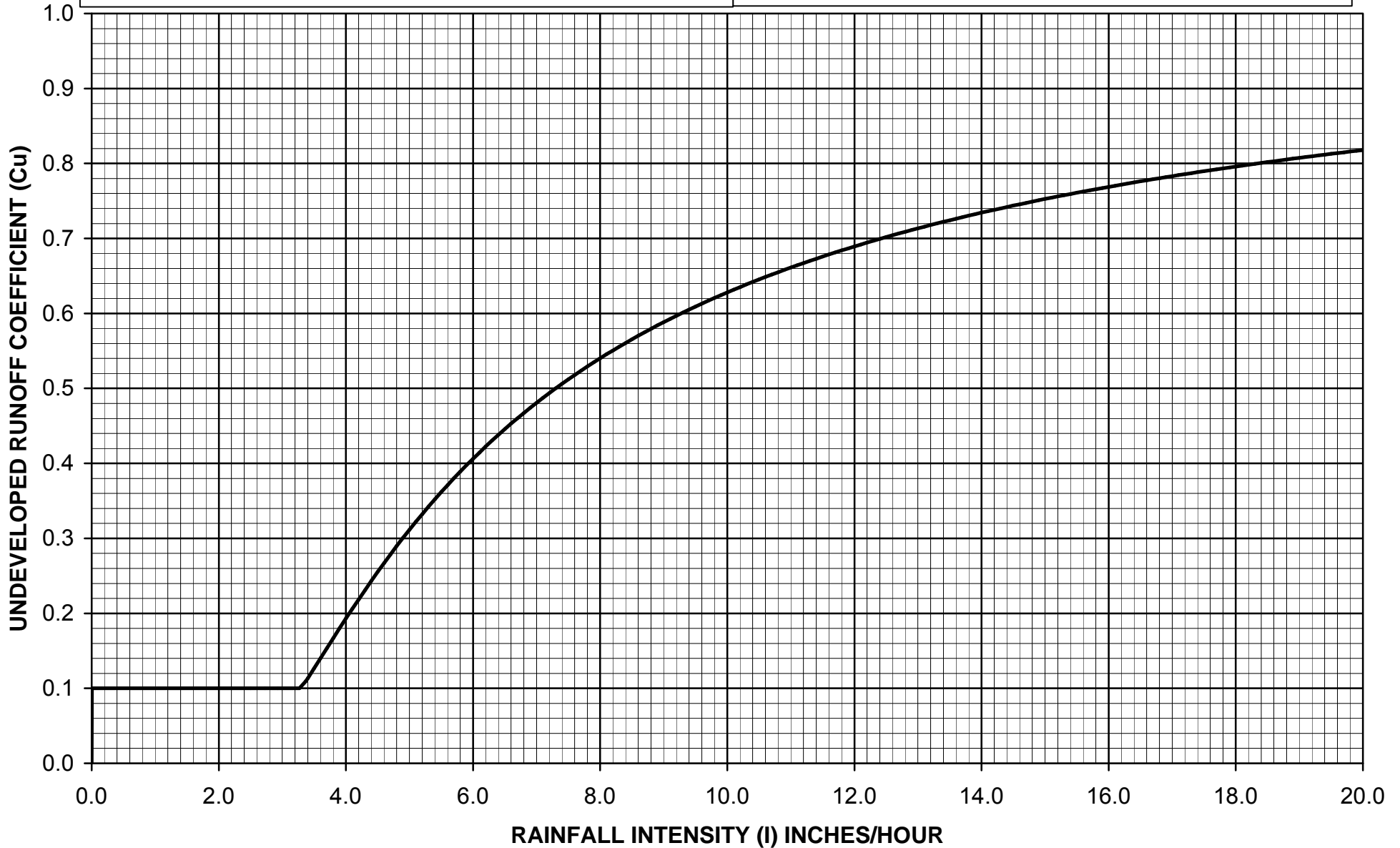

$$C_D = (0.9 * IMP) + (1.0 - IMP) * C_U$$

Where: C_D = Developed Runoff Coefficient
 IMP = Proportion Impervious
 C_U = Undeveloped runoff coefficient



Los Angeles County Department of Public Works

RUNOFF COEFFICIENT CURVE
SOIL TYPE NO. 132

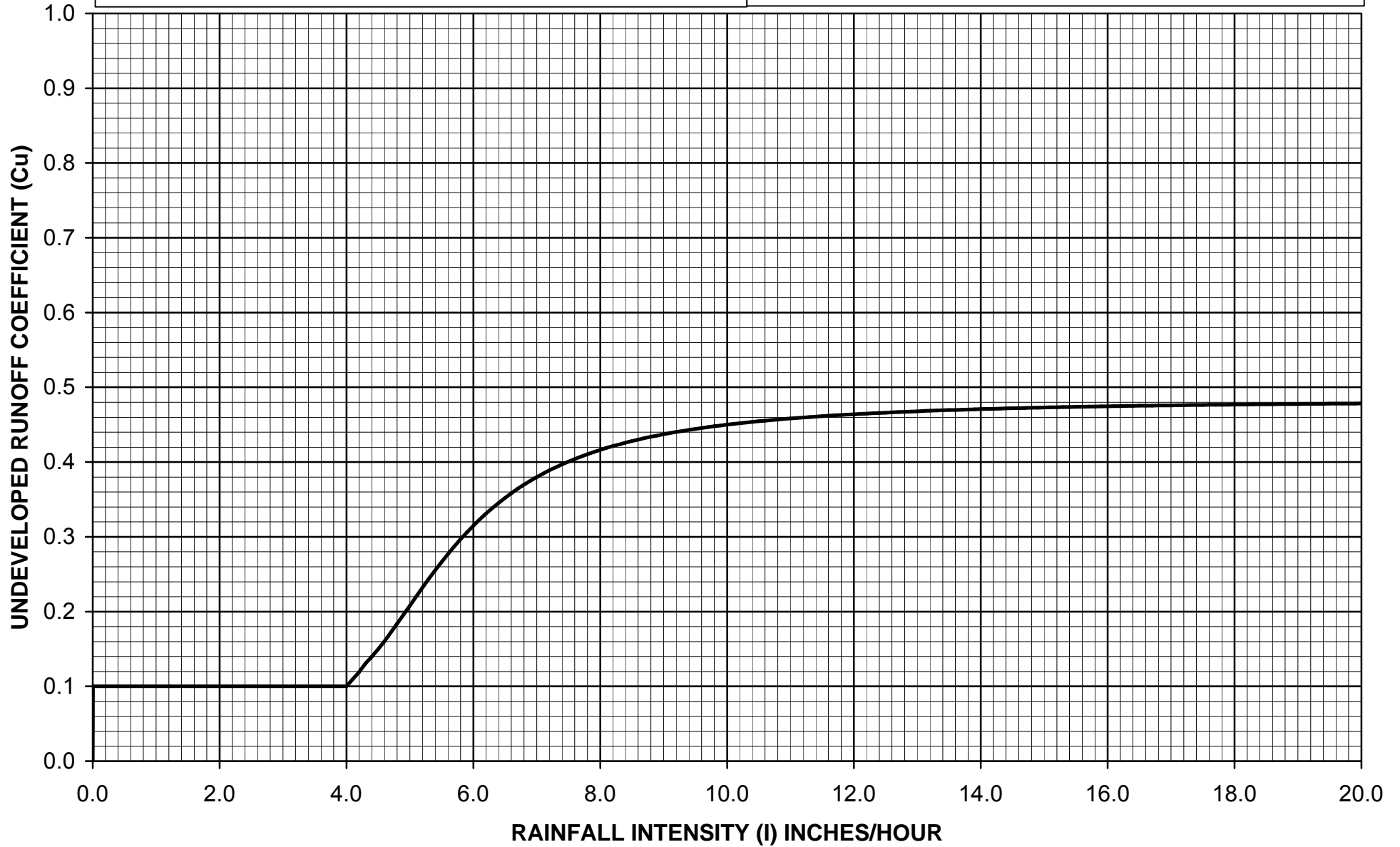

$C_D = (0.9 * IMP) + (1.0 - IMP) * C_U$
 Where: C_D = Developed Runoff Coefficient
 IMP = Proportion Impervious
 C_U = Undeveloped runoff coefficient



Los Angeles County Department of Public Works

RUNOFF COEFFICIENT CURVE
SOIL TYPE NO. 133

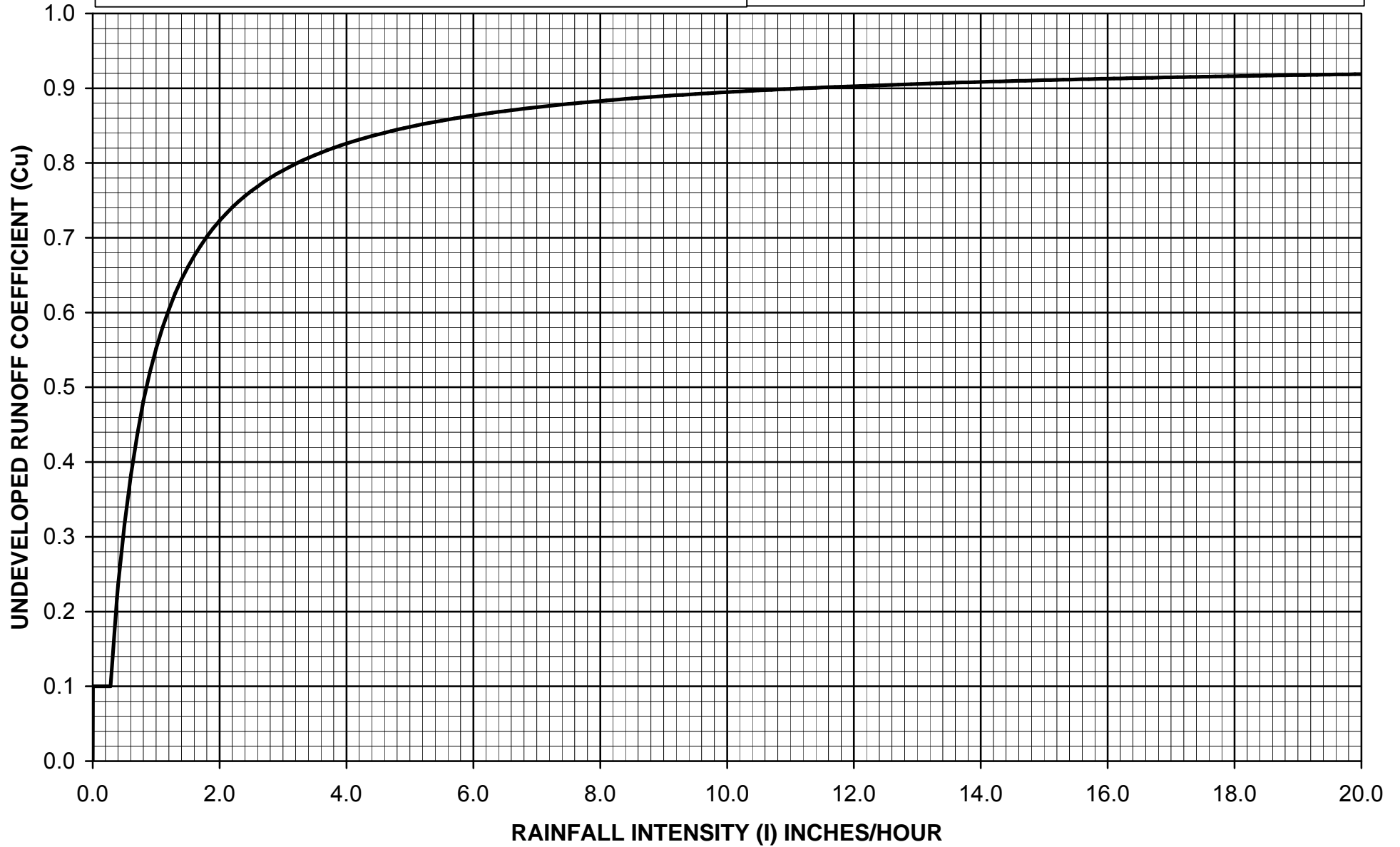

$$C_D = (0.9 * IMP) + (1.0 - IMP) * C_U$$

Where: C_D = Developed Runoff Coefficient
 IMP = Proportion Impervious
 C_U = Undeveloped runoff coefficient



Los Angeles County Department of Public Works

RUNOFF COEFFICIENT CURVE SOIL TYPE NO. 134

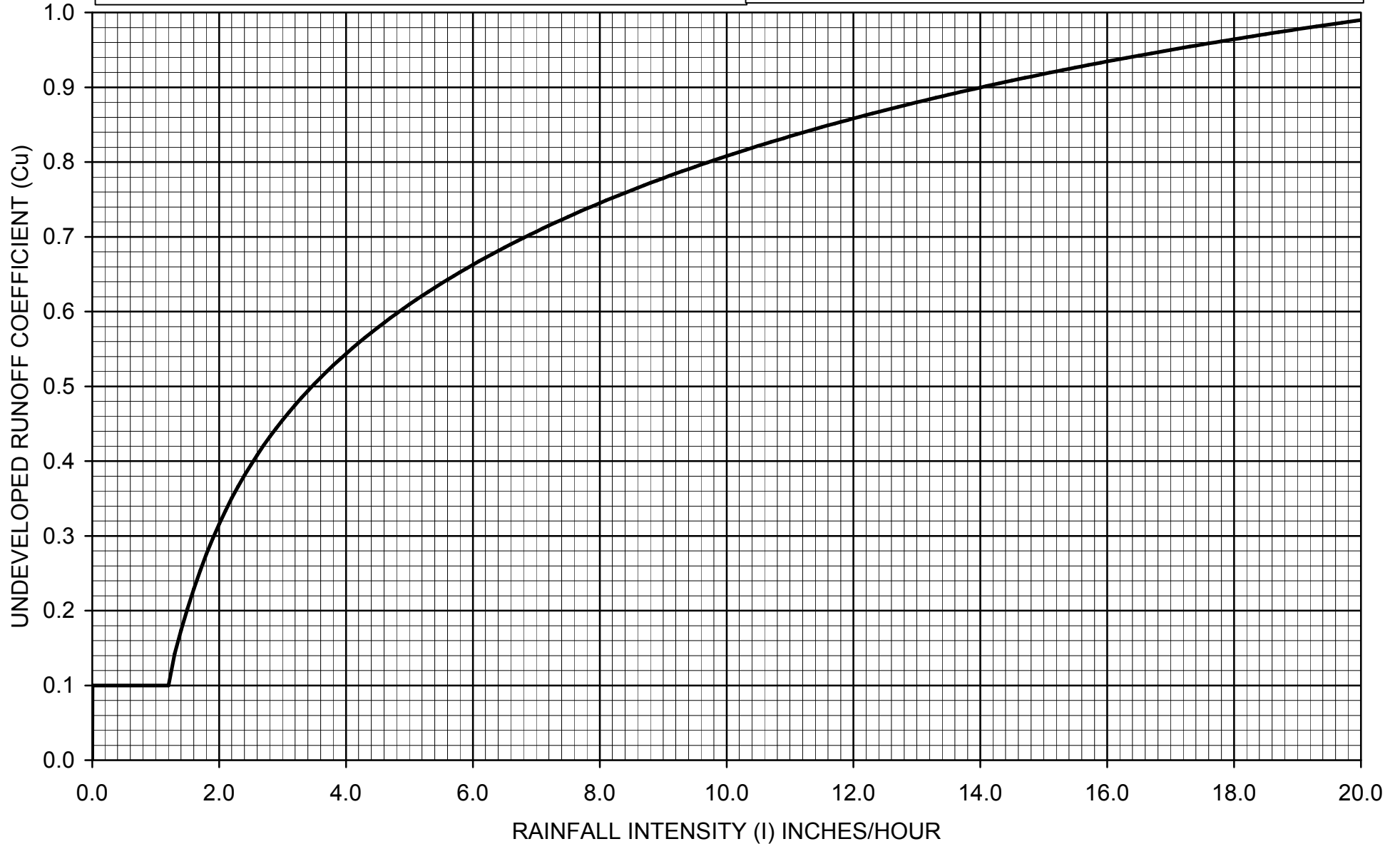

$C_D = (0.9 * IMP) + (1.0 - IMP) * C_U$
 Where: C_D = Developed Runoff Coefficient
 IMP = Proportion Impervious
 C_U = Undeveloped runoff coefficient



Los Angeles County Department of Public Works

RUNOFF COEFFICIENT CURVE
SOIL TYPE NO. 135

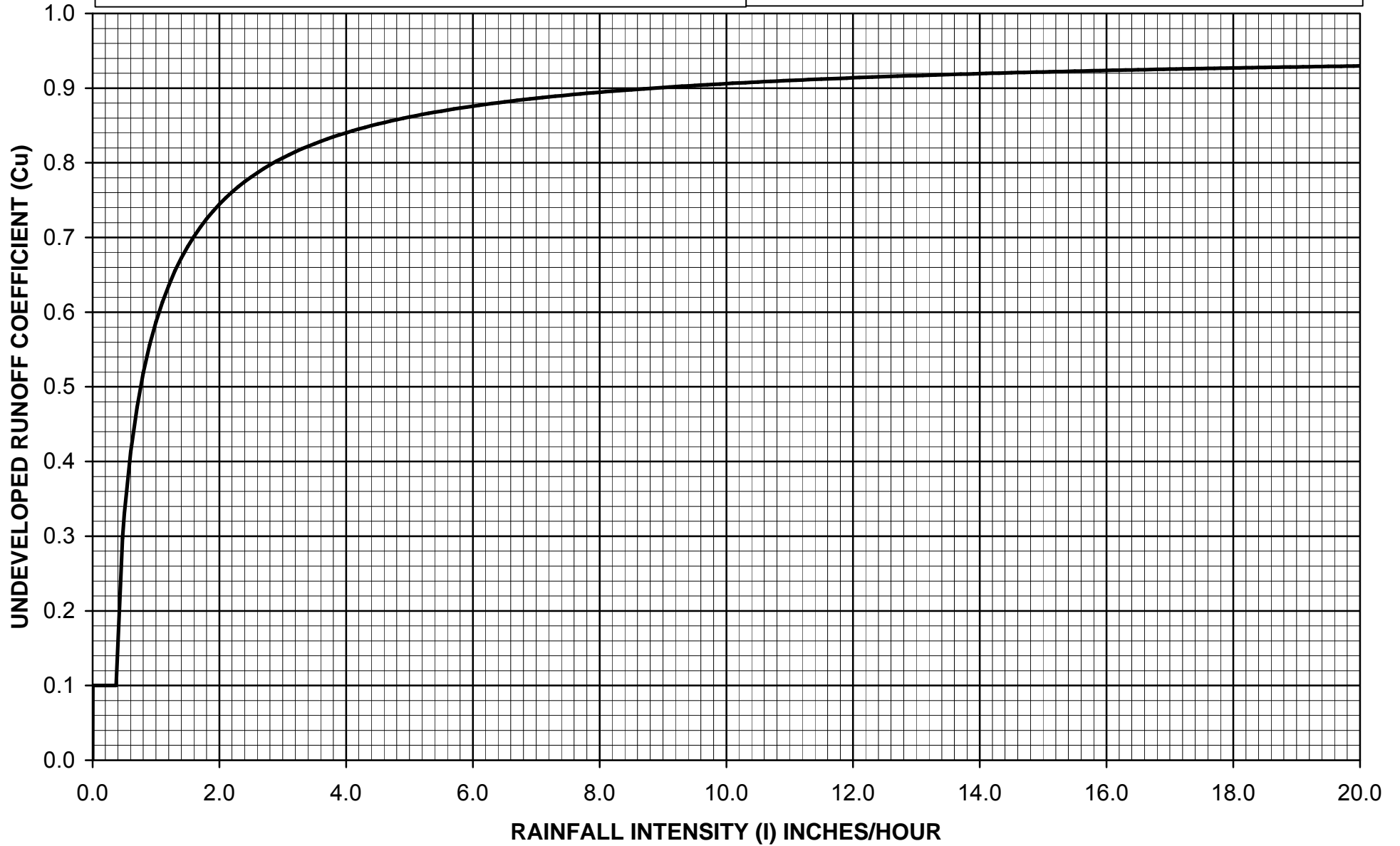

$C_D = (0.9 * IMP) + (1.0 - IMP) * C_U$
 Where: C_D = Developed Runoff Coefficient
 IMP = Proportion Impervious
 C_U = Undeveloped runoff coefficient



Los Angeles County Department of Public Works

RUNOFF COEFFICIENT CURVE
SOIL TYPE NO. 136

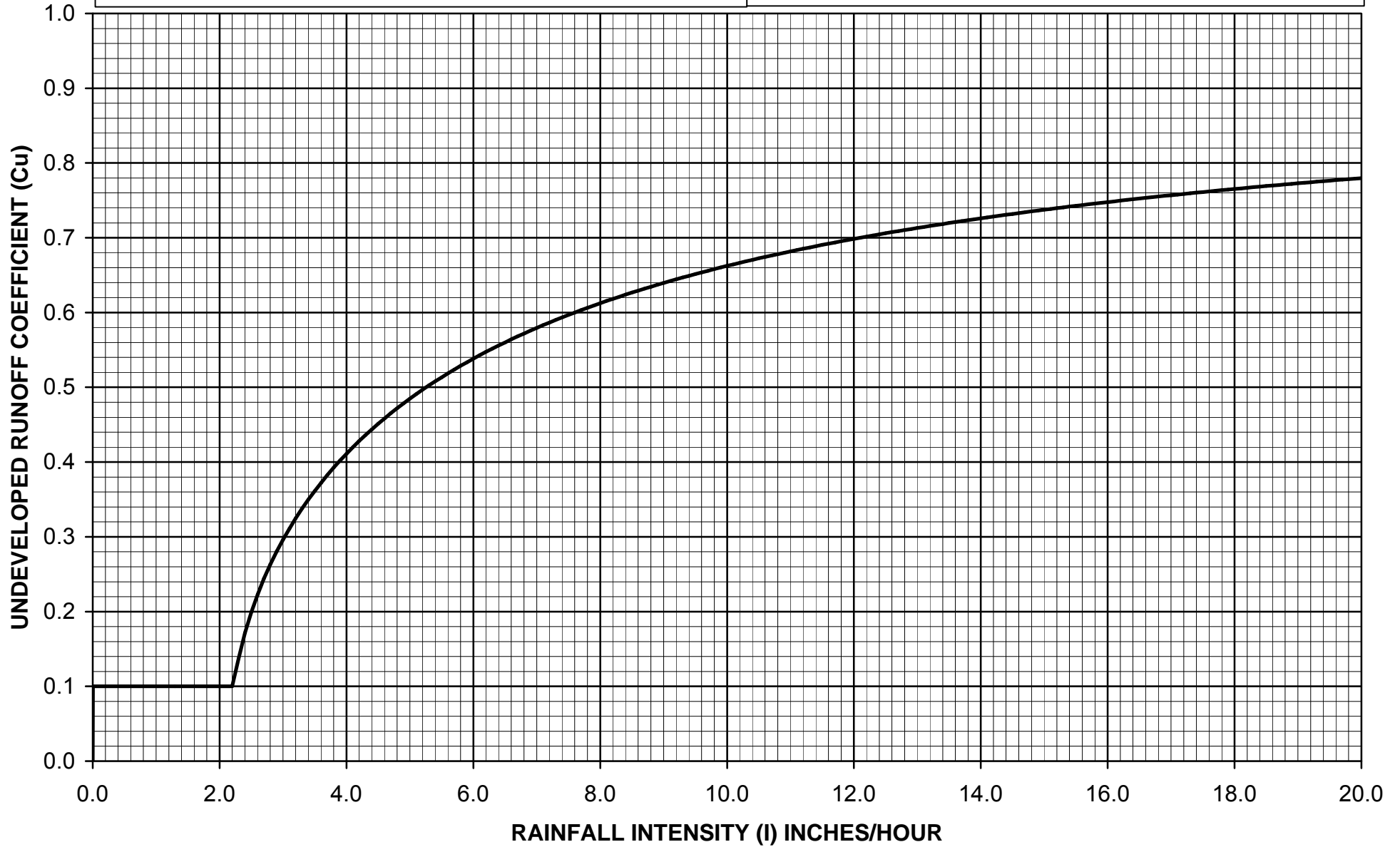

$C_D = (0.9 * IMP) + (1.0 - IMP) * C_U$
 Where: C_D = Developed Runoff Coefficient
 IMP = Proportion Impervious
 C_U = Undeveloped runoff coefficient



Los Angeles County Department of Public Works

RUNOFF COEFFICIENT CURVE
SOIL TYPE NO. 137

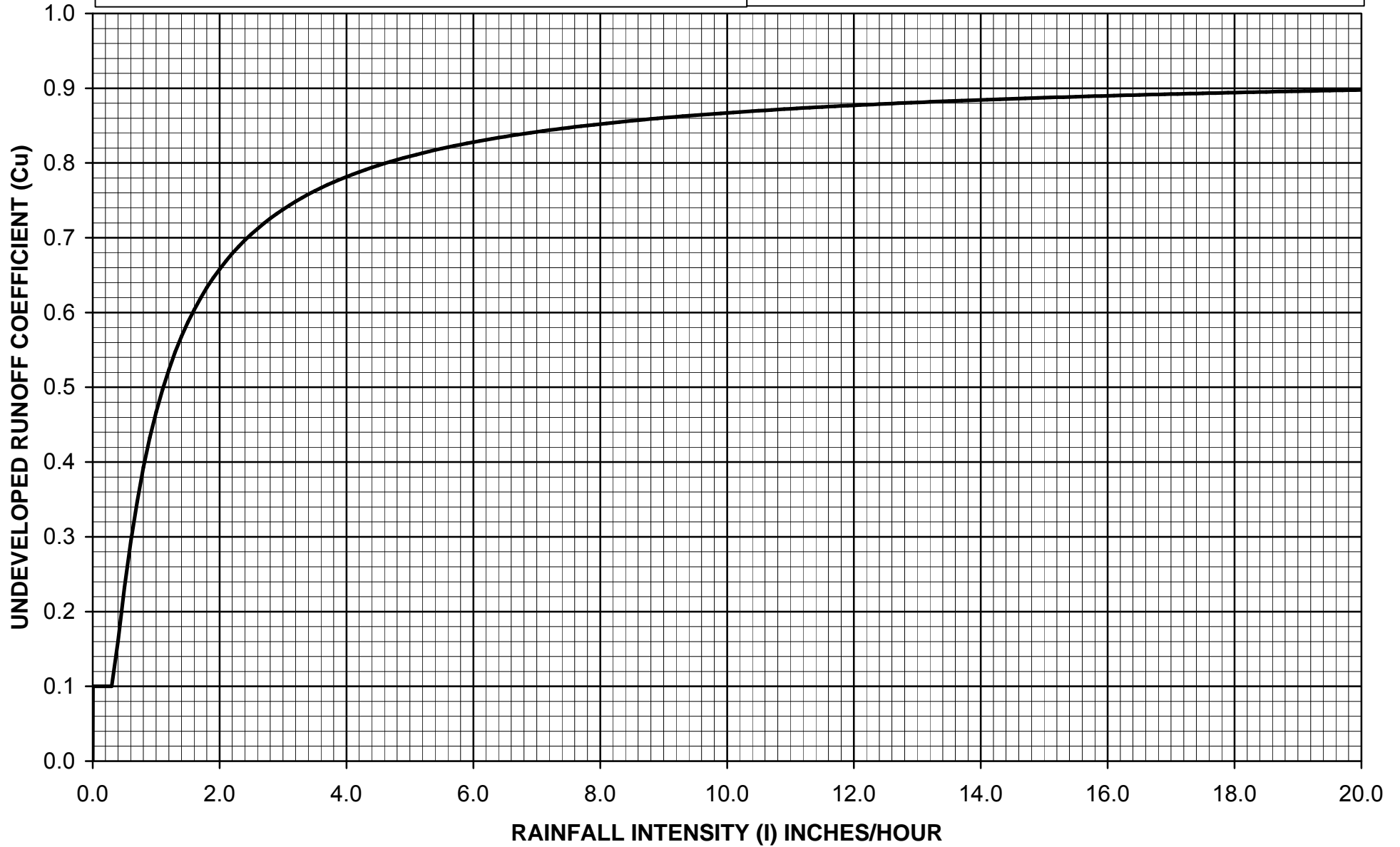

$$C_D = (0.9 * IMP) + (1.0 - IMP) * C_U$$

Where: C_D = Developed Runoff Coefficient
 IMP = Proportion Impervious
 C_U = Undeveloped runoff coefficient



Los Angeles County Department of Public Works

RUNOFF COEFFICIENT CURVE
SOIL TYPE NO. 138

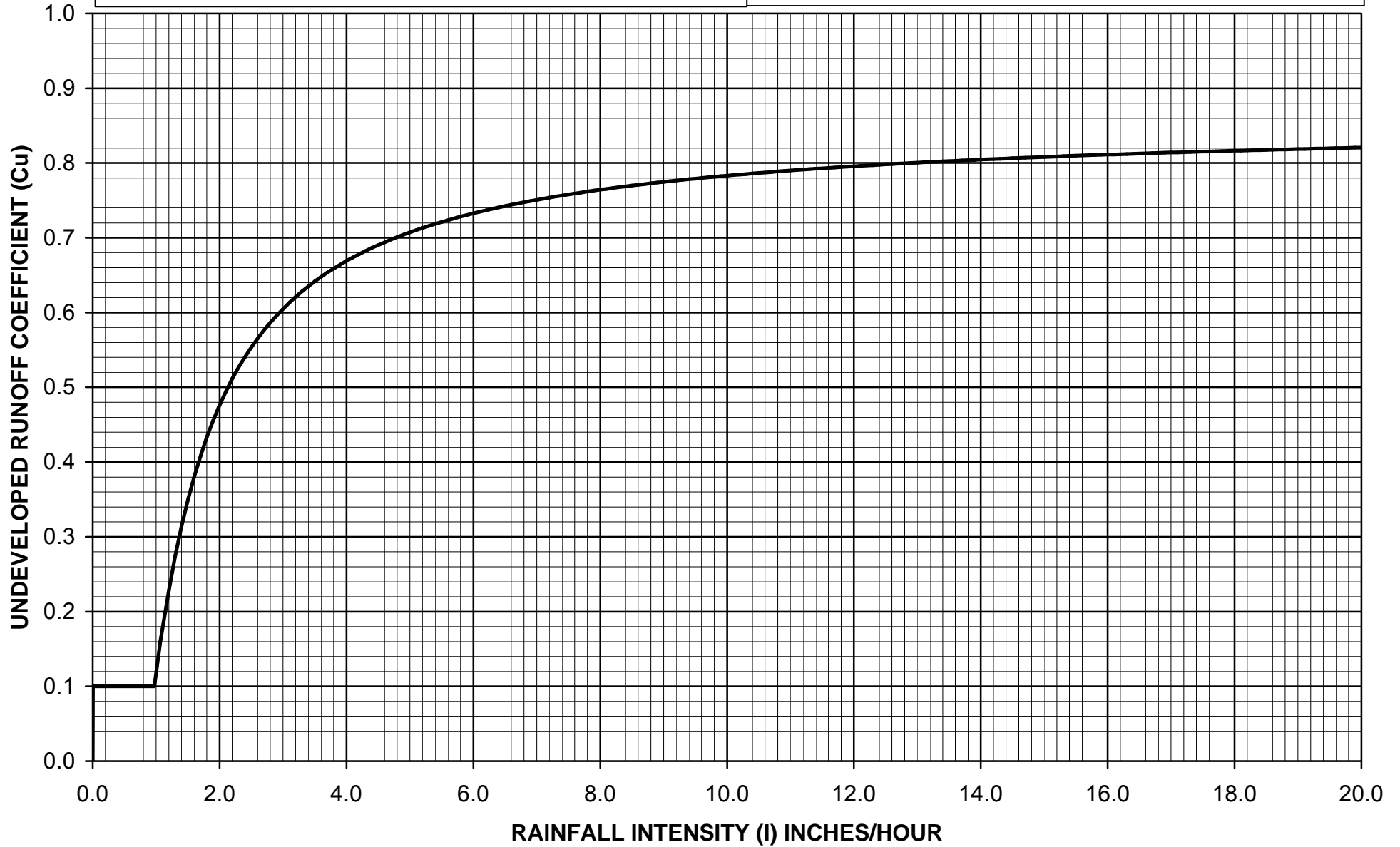

$$C_D = (0.9 * IMP) + (1.0 - IMP) * C_U$$

Where: C_D = Developed Runoff Coefficient
 IMP = Proportion Impervious
 C_U = Undeveloped runoff coefficient



Los Angeles County Department of Public Works

RUNOFF COEFFICIENT CURVE
SOIL TYPE NO. 139

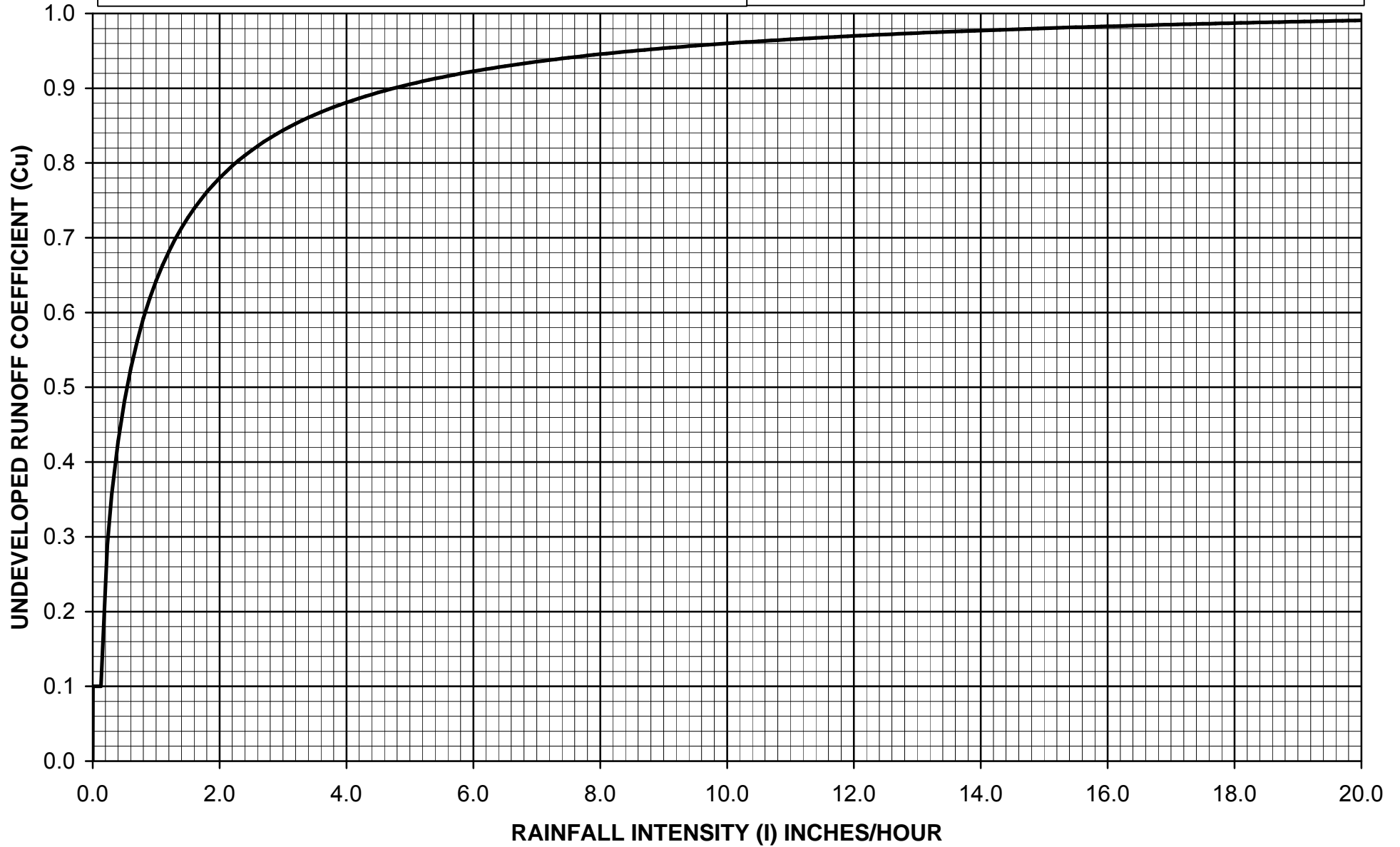

$$C_D = (0.9 * IMP) + (1.0 - IMP) * C_U$$

Where: C_D = Developed Runoff Coefficient
IMP = Proportion Impervious
 C_U = Undeveloped runoff coefficient



Los Angeles County Department of Public Works

RUNOFF COEFFICIENT CURVE
SOIL TYPE NO. 140

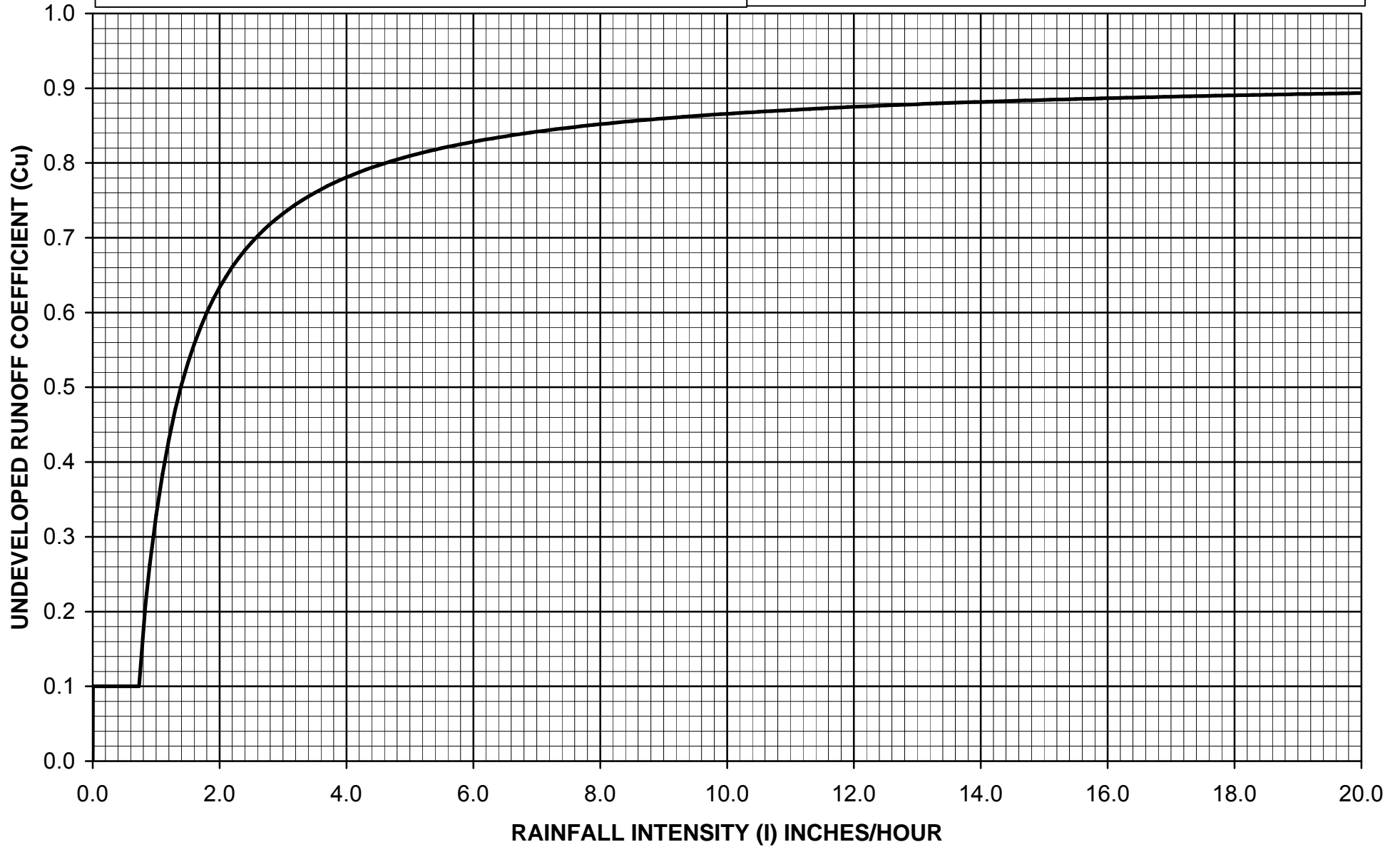

$$C_D = (0.9 * IMP) + (1.0 - IMP) * C_U$$

Where: C_D = Developed Runoff Coefficient
 IMP = Proportion Impervious
 C_U = Undeveloped runoff coefficient



Los Angeles County Department of Public Works

RUNOFF COEFFICIENT CURVE
SOIL TYPE NO. 141

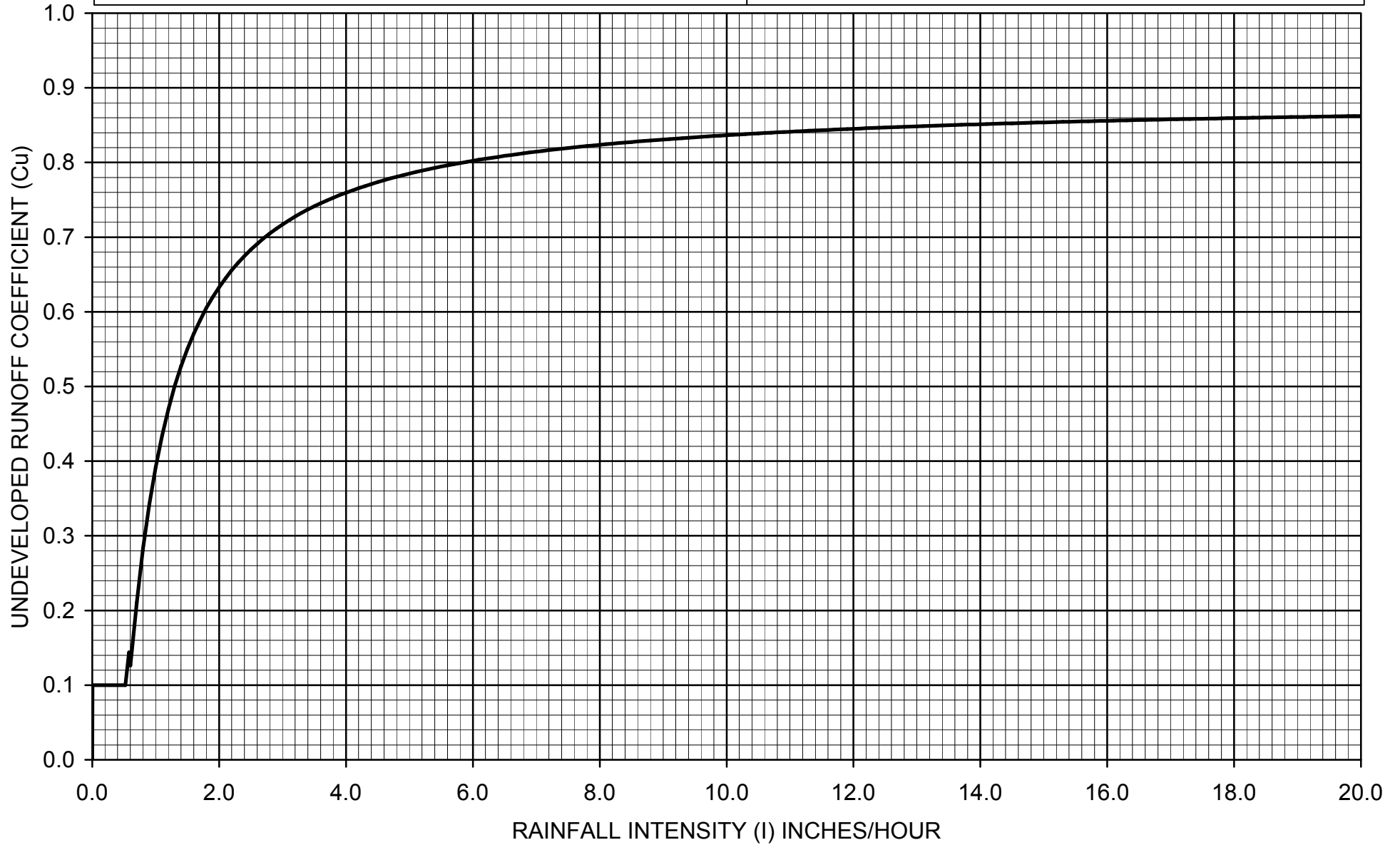

$C_D = (0.9 * IMP) + (1.0 - IMP) * C_U$
 Where: C_D = Developed Runoff Coefficient
 IMP = Proportion Impervious
 C_U = Undeveloped runoff coefficient



Los Angeles County Department of Public Works

RUNOFF COEFFICIENT CURVE
SOIL TYPE NO. 142

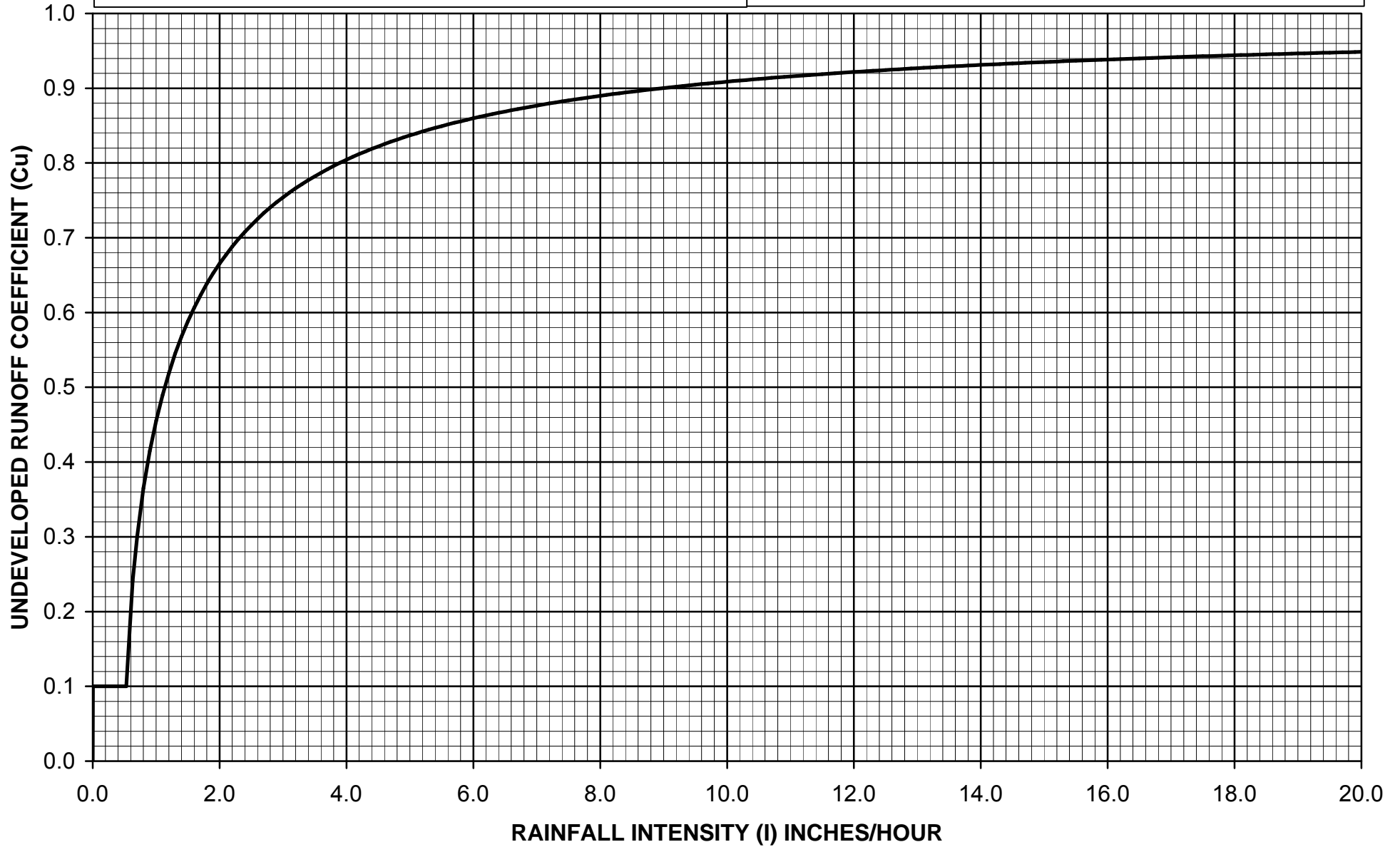

$C_D = (0.9 * IMP) + (1.0 - IMP) * C_U$
 Where: C_D = Developed Runoff Coefficient
 IMP = Proportion Impervious
 C_U = Undeveloped runoff coefficient



Los Angeles County Department of Public Works

**RUNOFF COEFFICIENT CURVE
SOIL TYPE NO. 143**

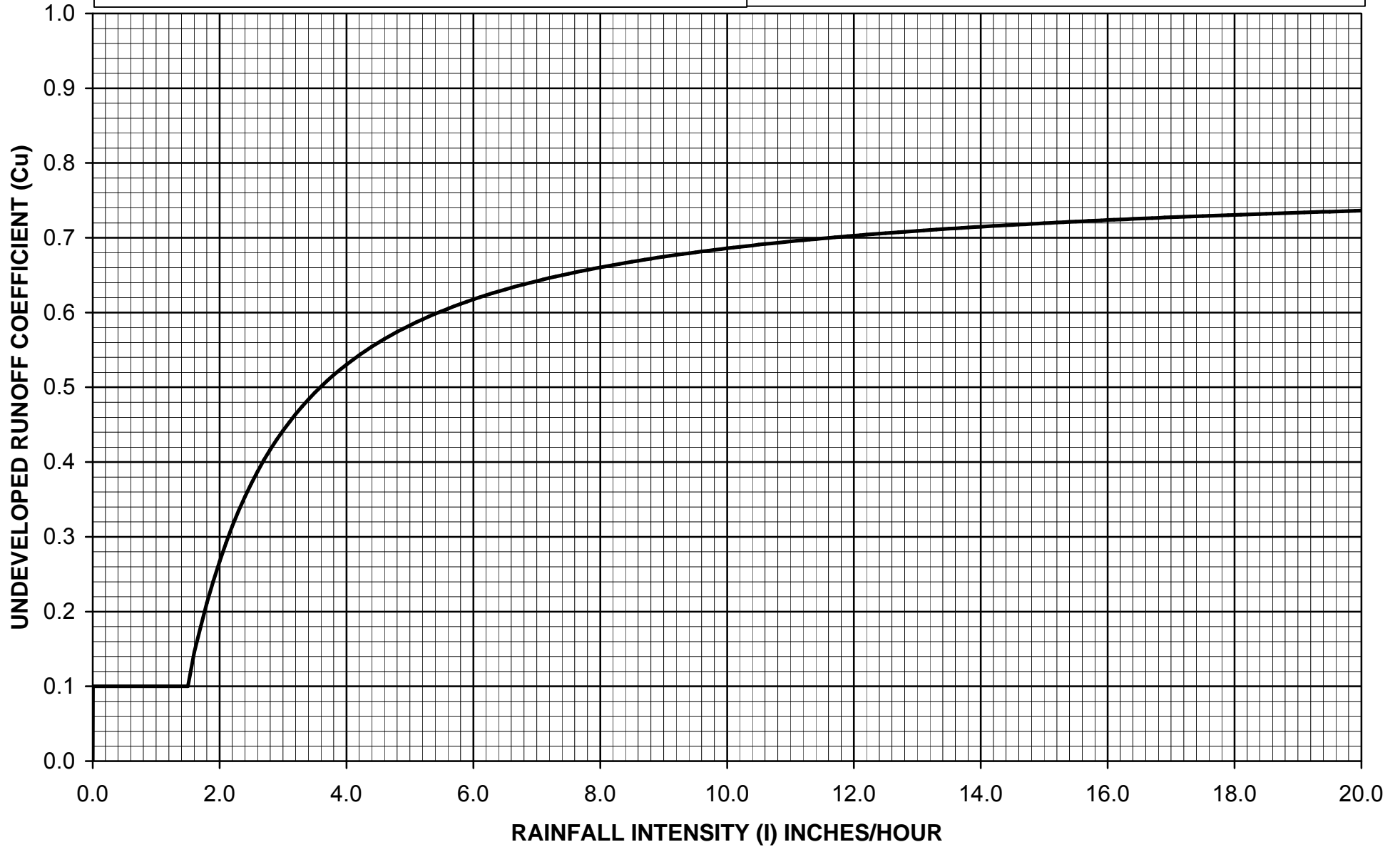

$C_D = (0.9 * IMP) + (1.0 - IMP) * C_U$
 Where: C_D = Developed Runoff Coefficient
 IMP = Proportion Impervious
 C_U = Undeveloped runoff coefficient



Los Angeles County Department of Public Works

RUNOFF COEFFICIENT CURVE
SOIL TYPE NO. 144

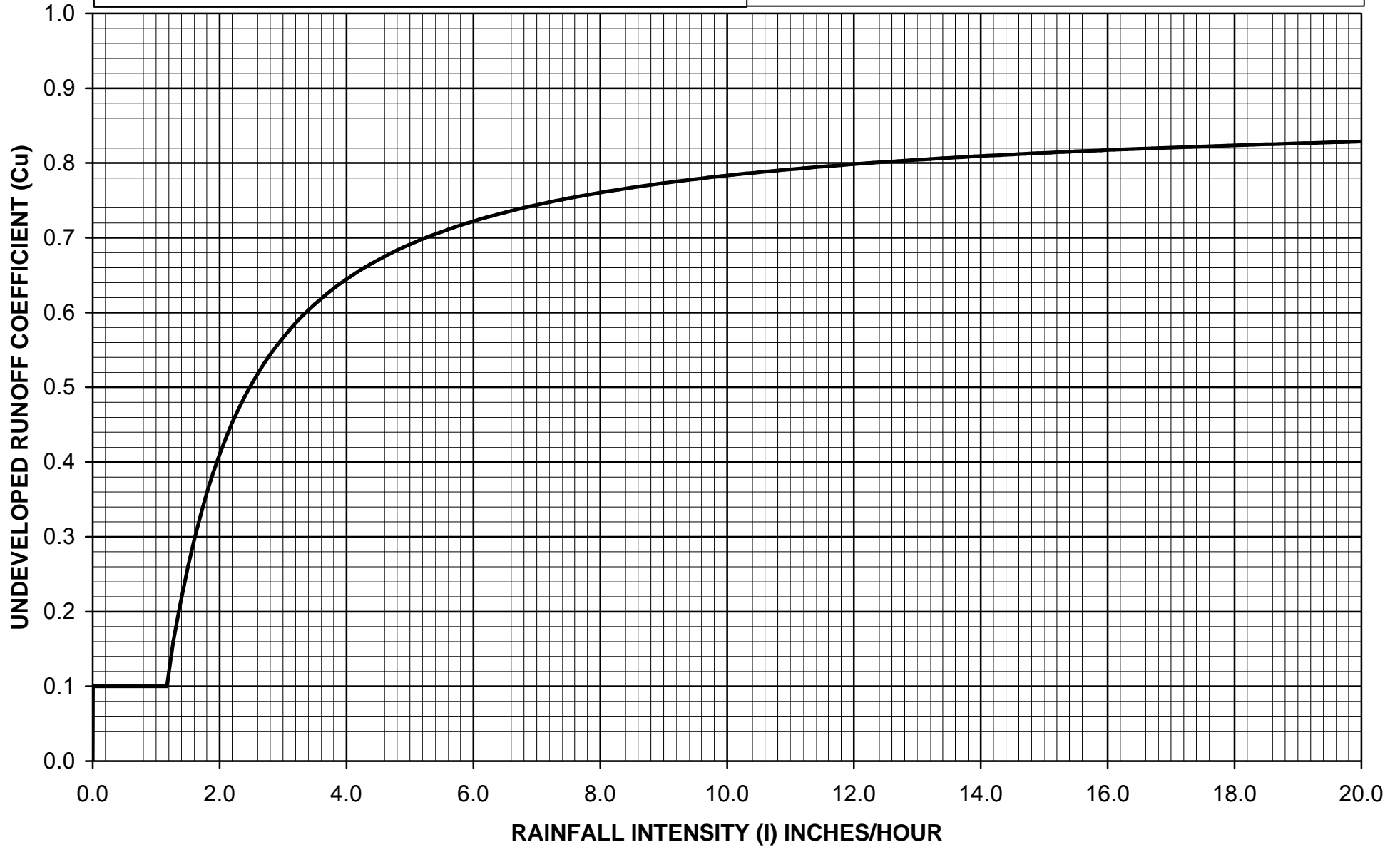

$$C_D = (0.9 * IMP) + (1.0 - IMP) * C_U$$

Where: C_D = Developed Runoff Coefficient
 IMP = Proportion Impervious
 C_U = Undeveloped runoff coefficient



Los Angeles County Department of Public Works

RUNOFF COEFFICIENT CURVE
SOIL TYPE NO. 145

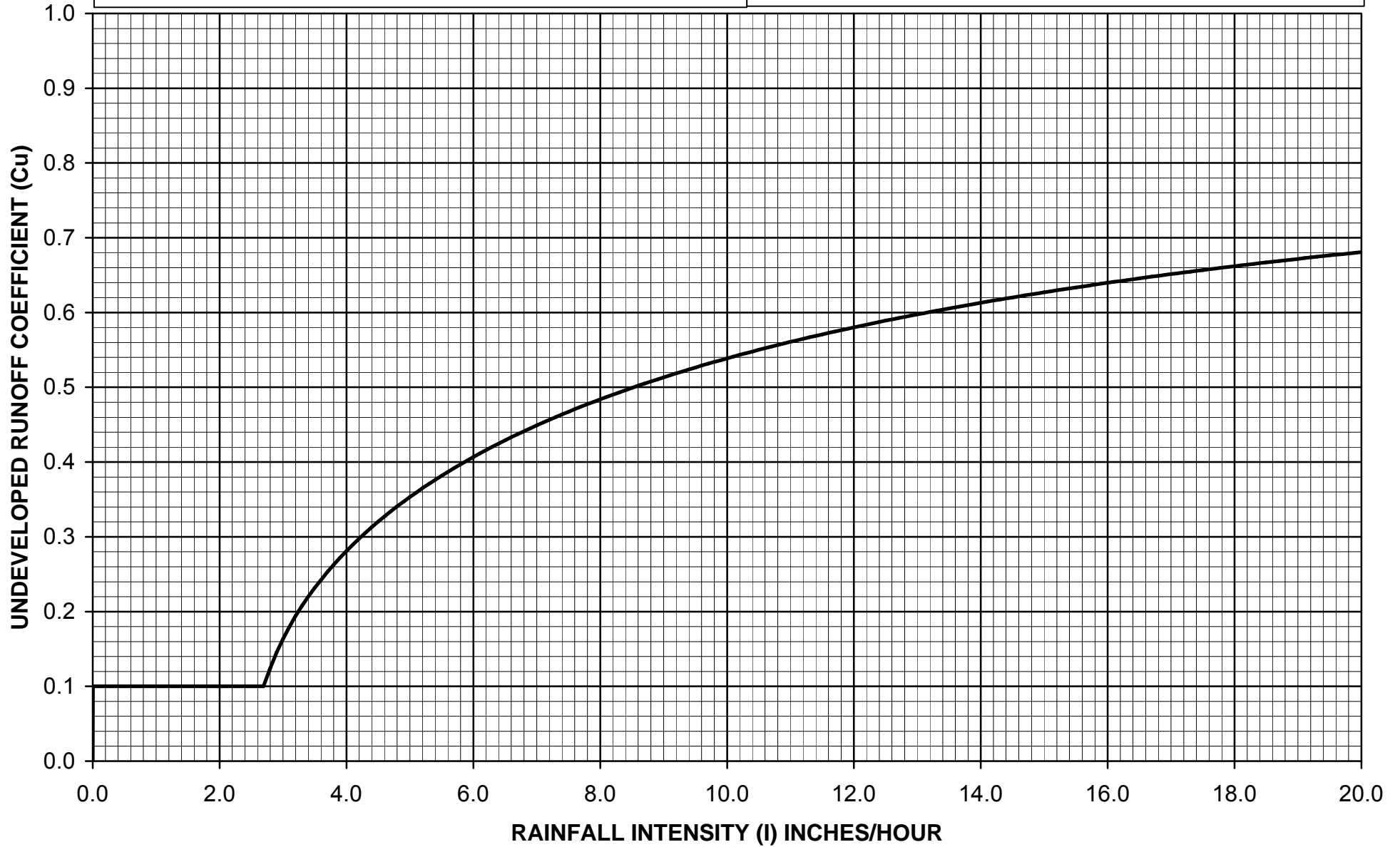

$C_D = (0.9 * IMP) + (1.0 - IMP) * C_U$
 Where: C_D = Developed Runoff Coefficient
 IMP = Proportion Impervious
 C_U = Undeveloped runoff coefficient



Los Angeles County Department of Public Works

**RUNOFF COEFFICIENT CURVE
SOIL TYPE NO. 146**

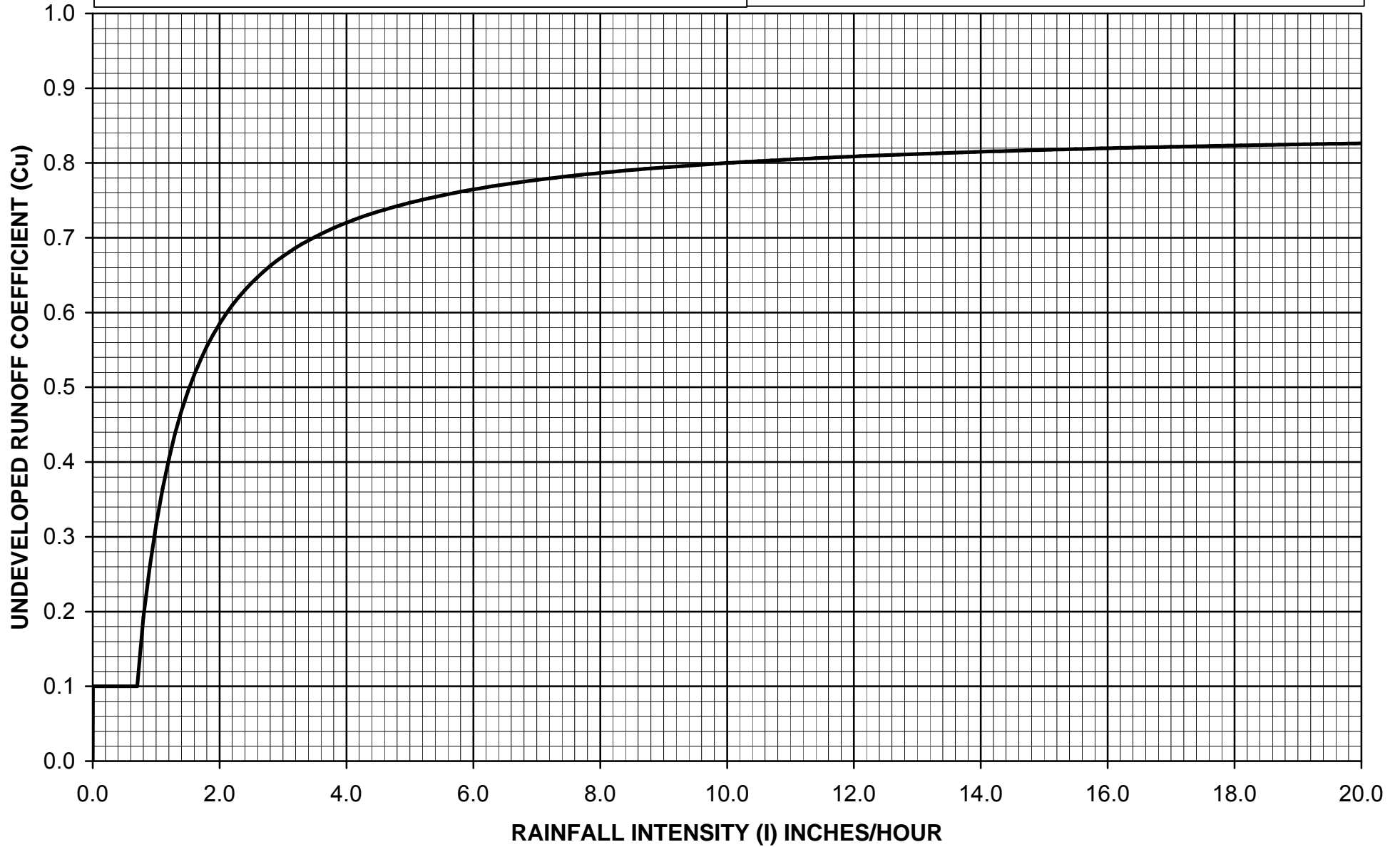

$C_D = (0.9 * IMP) + (1.0 - IMP) * C_U$
 Where: C_D = Developed Runoff Coefficient
 IMP = Proportion Impervious
 C_U = Undeveloped runoff coefficient



Los Angeles County Department of Public Works

RUNOFF COEFFICIENT CURVE
SOIL TYPE NO. 147

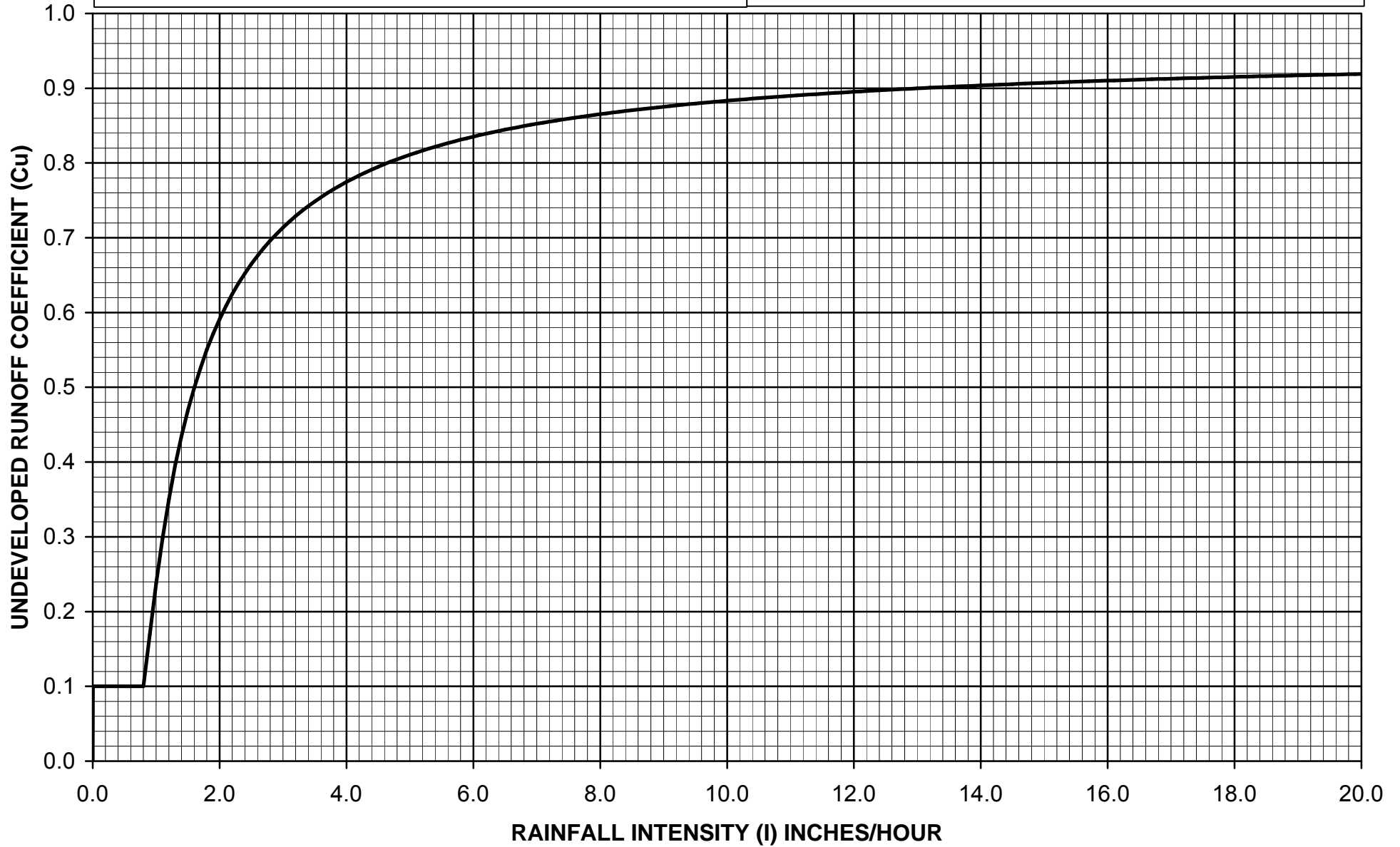

$C_D = (0.9 * IMP) + (1.0 - IMP) * C_U$
 Where: C_D = Developed Runoff Coefficient
 IMP = Proportion Impervious
 C_U = Undeveloped runoff coefficient



Los Angeles County Department of Public Works

**RUNOFF COEFFICIENT CURVE
SOIL TYPE NO. 148**

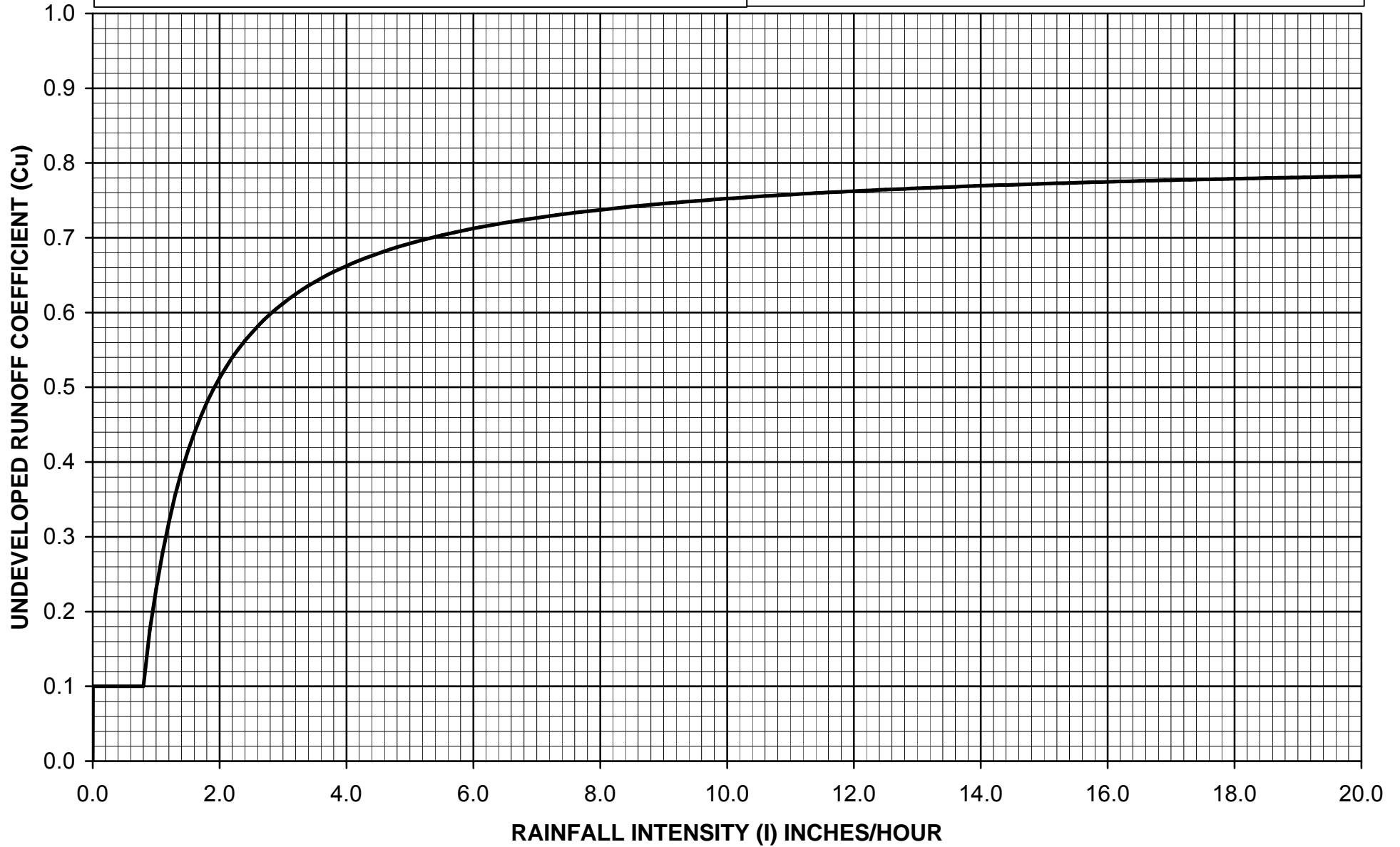

$C_D = (0.9 * IMP) + (1.0 - IMP) * C_U$
 Where: C_D = Developed Runoff Coefficient
 IMP = Proportion Impervious
 C_U = Undeveloped runoff coefficient



Los Angeles County Department of Public Works

RUNOFF COEFFICIENT CURVE
SOIL TYPE NO. 149

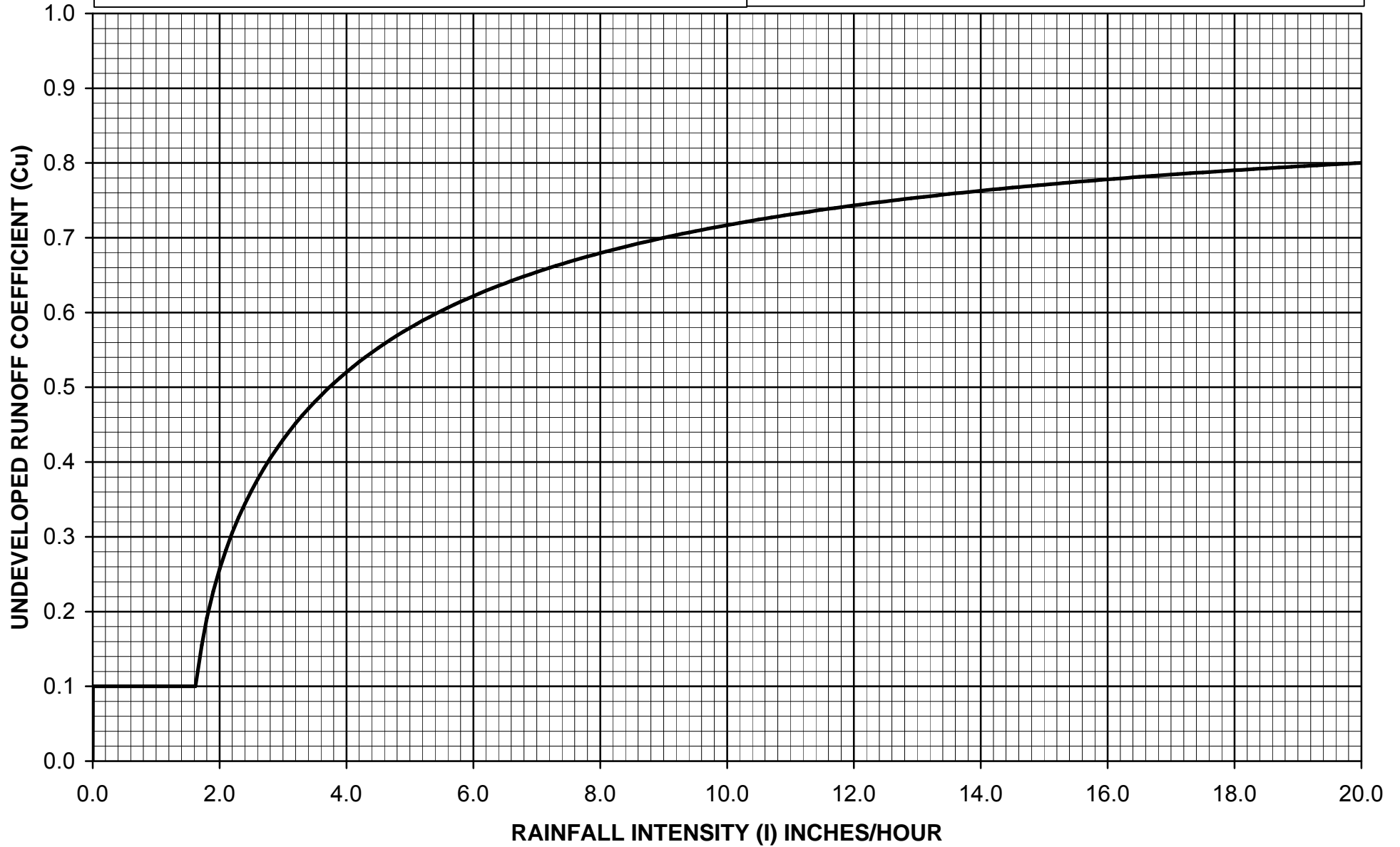

$C_D = (0.9 * IMP) + (1.0 - IMP) * C_U$
 Where: C_D = Developed Runoff Coefficient
 IMP = Proportion Impervious
 C_U = Undeveloped runoff coefficient



Los Angeles County Department of Public Works

RUNOFF COEFFICIENT CURVE
SOIL TYPE NO. 150

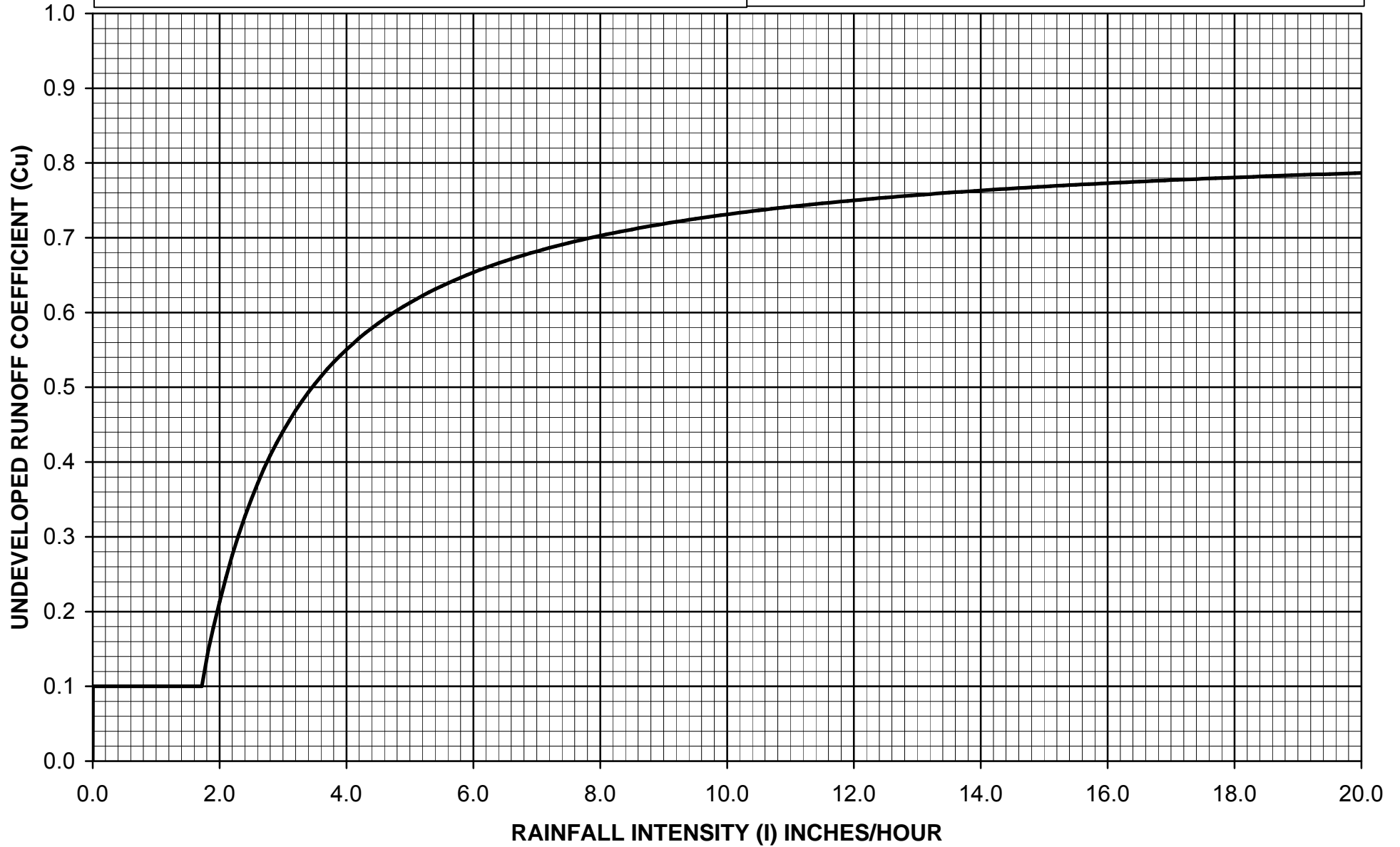

$C_D = (0.9 * IMP) + (1.0 - IMP) * C_U$
 Where: C_D = Developed Runoff Coefficient
 IMP = Proportion Impervious
 C_U = Undeveloped runoff coefficient



Los Angeles County Department of Public Works

RUNOFF COEFFICIENT CURVE
SOIL TYPE NO. 151

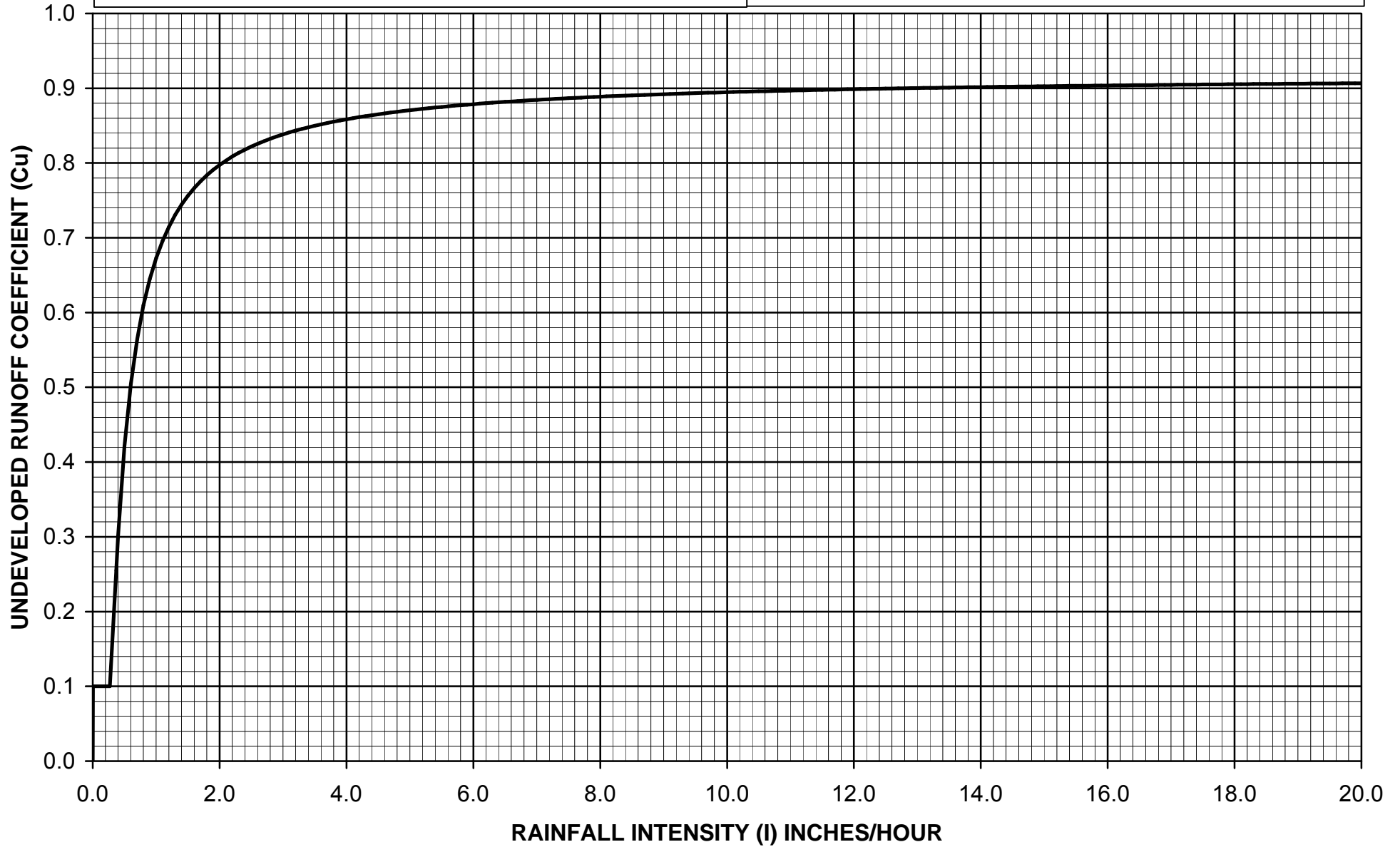

$C_D = (0.9 * IMP) + (1.0 - IMP) * C_U$
 Where: C_D = Developed Runoff Coefficient
 IMP = Proportion Impervious
 C_U = Undeveloped runoff coefficient



Los Angeles County Department of Public Works

RUNOFF COEFFICIENT CURVE
SOIL TYPE NO. 152

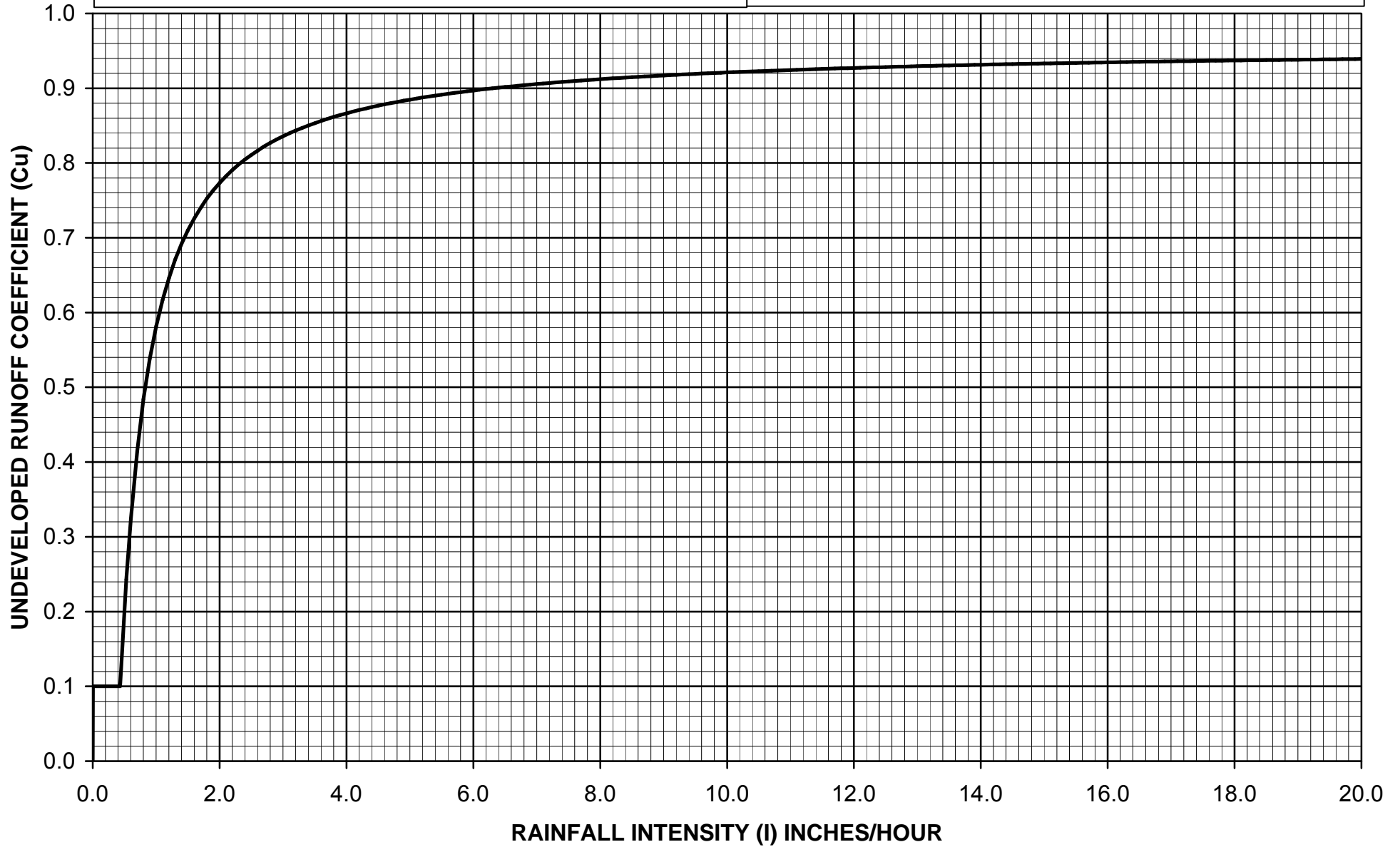

$C_D = (0.9 * IMP) + (1.0 - IMP) * C_U$
 Where: C_D = Developed Runoff Coefficient
 IMP = Proportion Impervious
 C_U = Undeveloped runoff coefficient



Los Angeles County Department of Public Works

RUNOFF COEFFICIENT CURVE
SOIL TYPE NO. 153

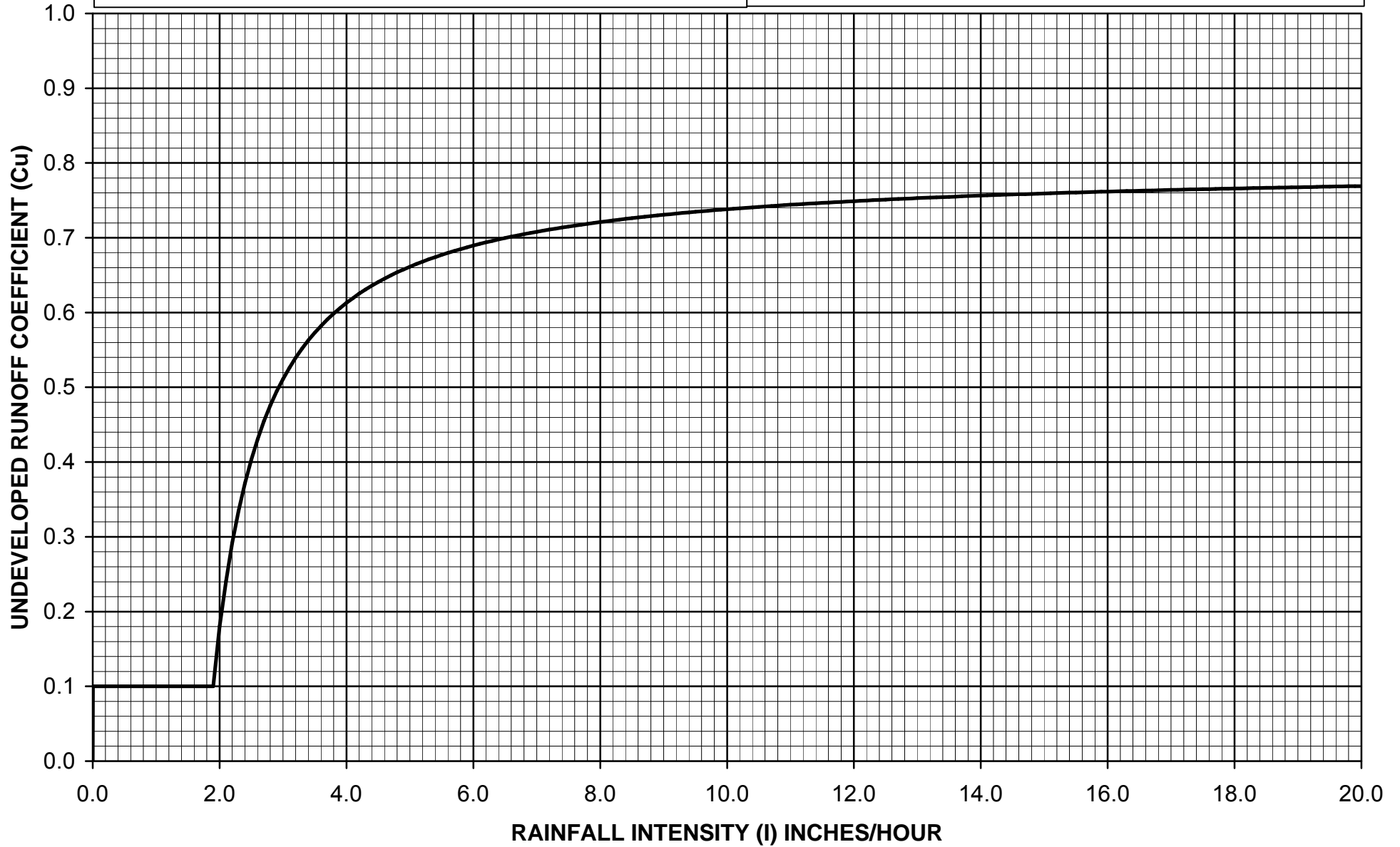

$C_D = (0.9 * IMP) + (1.0 - IMP) * C_U$
 Where: C_D = Developed Runoff Coefficient
 IMP = Proportion Impervious
 C_U = Undeveloped runoff coefficient



Los Angeles County Department of Public Works

RUNOFF COEFFICIENT CURVE
SOIL TYPE NO. 154

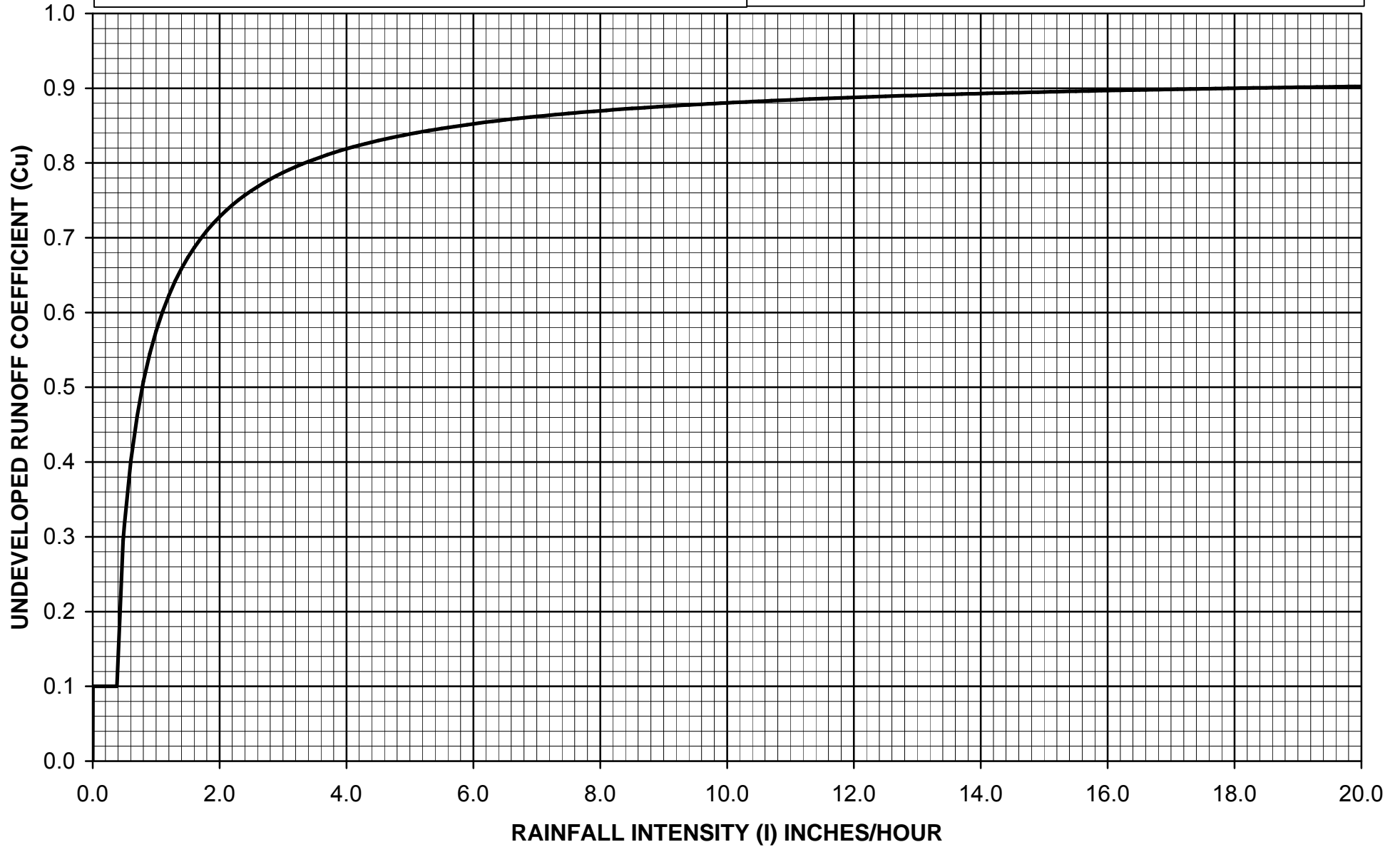

$C_D = (0.9 * IMP) + (1.0 - IMP) * C_U$
 Where: C_D = Developed Runoff Coefficient
 IMP = Proportion Impervious
 C_U = Undeveloped runoff coefficient



Los Angeles County Department of Public Works

RUNOFF COEFFICIENT CURVE
SOIL TYPE NO. 155

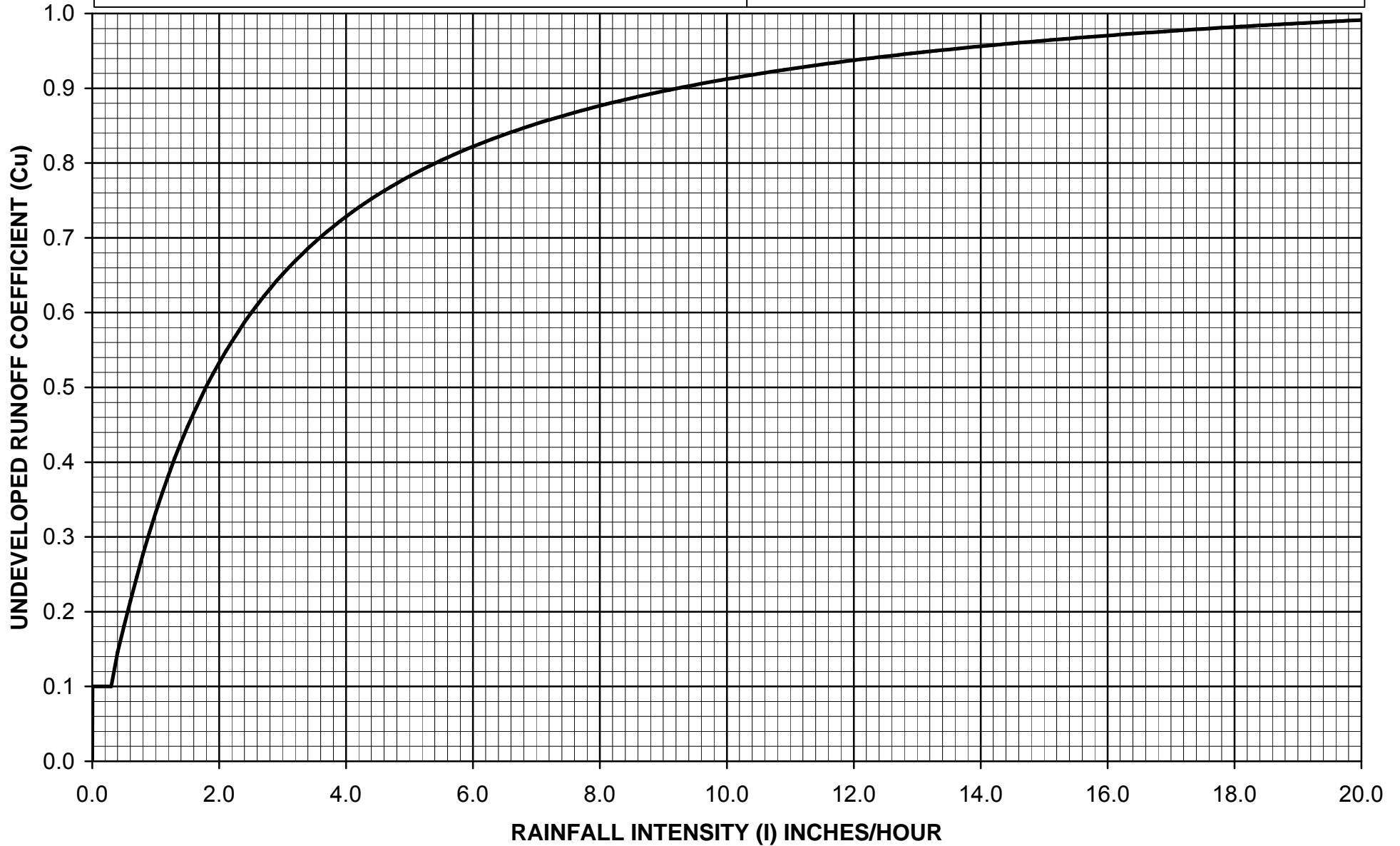

$C_D = (0.9 * IMP) + (1.0 - IMP) * C_U$
 Where: C_D = Developed Runoff Coefficient
 IMP = Proportion Impervious
 C_U = Undeveloped runoff coefficient



Los Angeles County Department of Public Works

RUNOFF COEFFICIENT CURVE
SOIL TYPE NO. 156

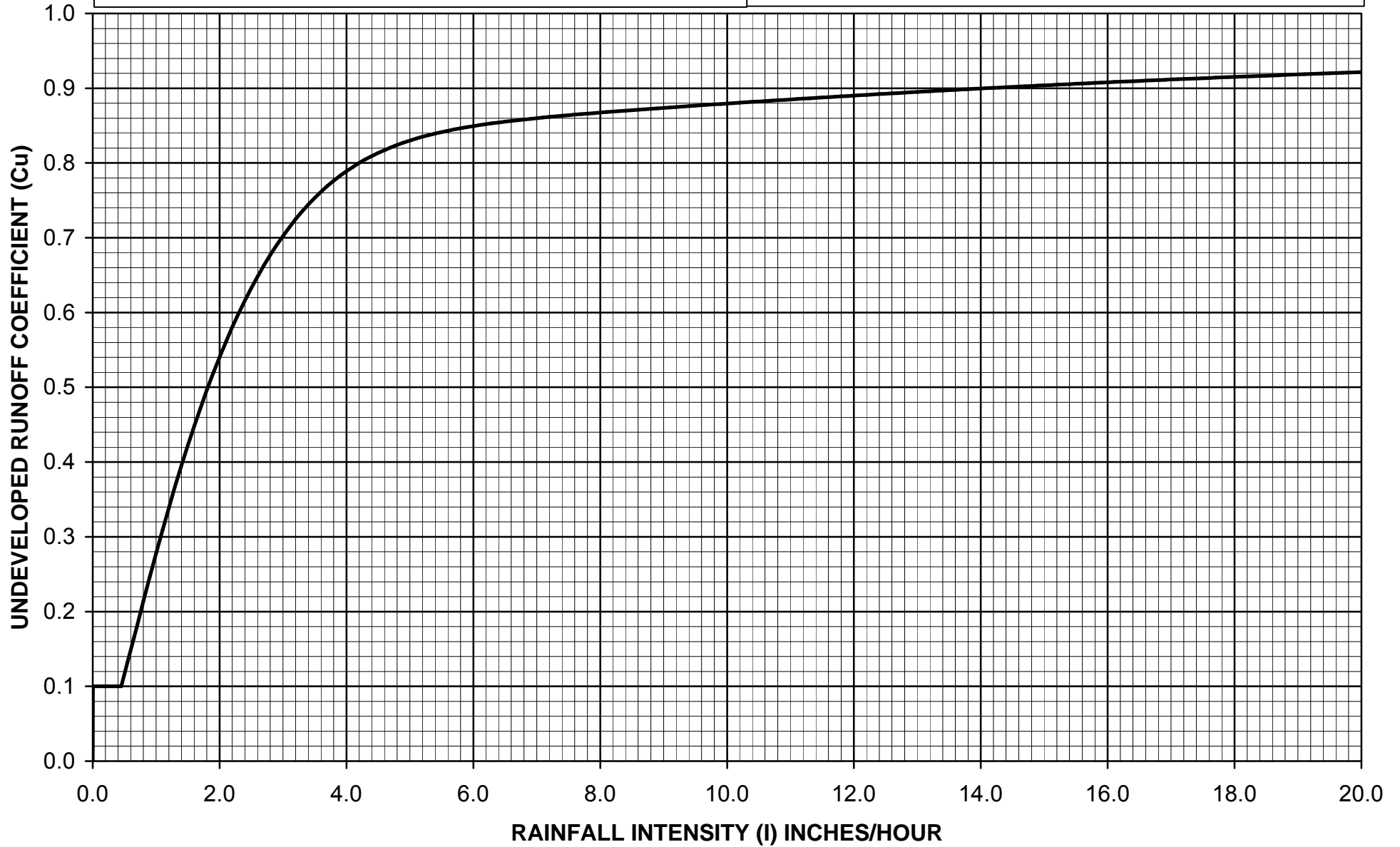

$C_D = (0.9 * IMP) + (1.0 - IMP) * C_U$
 Where: C_D = Developed Runoff Coefficient
 IMP = Proportion Impervious
 C_U = Undeveloped runoff coefficient



Los Angeles County Department of Public Works

RUNOFF COEFFICIENT CURVE
SOIL TYPE NO. 157

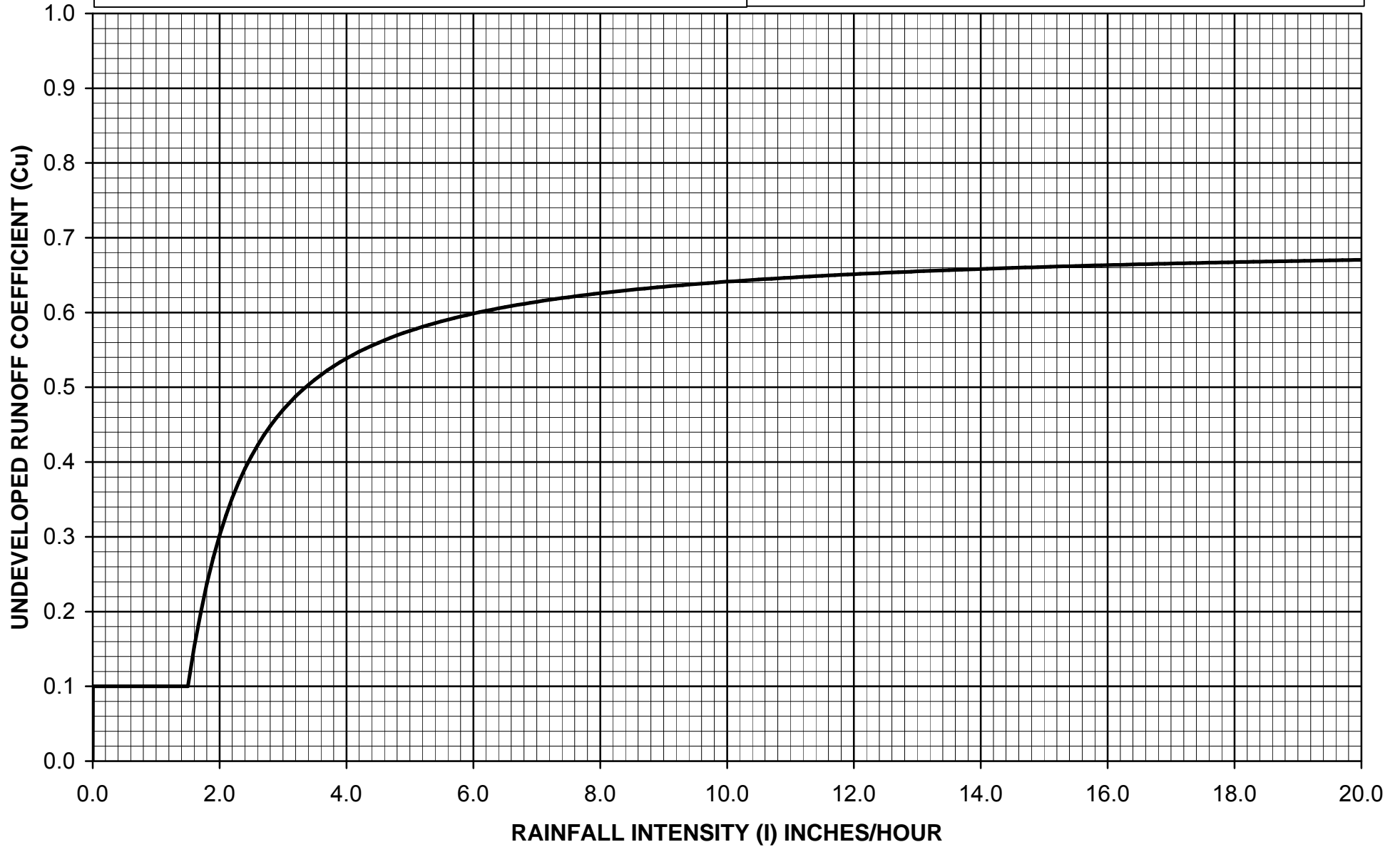

$C_D = (0.9 * IMP) + (1.0 - IMP) * C_U$
 Where: C_D = Developed Runoff Coefficient
 IMP = Proportion Impervious
 C_U = Undeveloped runoff coefficient



Los Angeles County Department of Public Works

RUNOFF COEFFICIENT CURVE
SOIL TYPE NO. 158

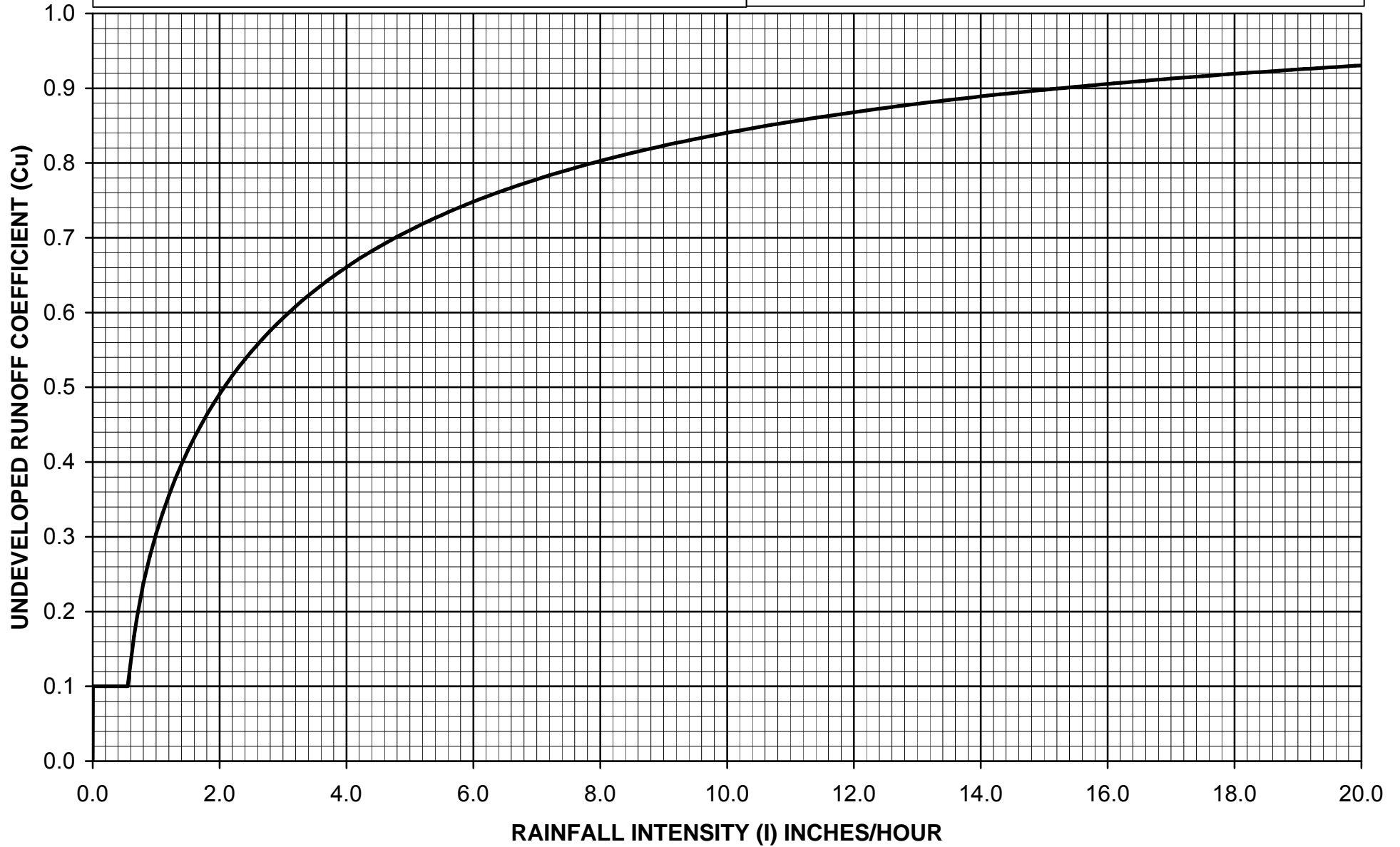

$C_D = (0.9 * IMP) + (1.0 - IMP) * C_U$
 Where: C_D = Developed Runoff Coefficient
 IMP = Proportion Impervious
 C_U = Undeveloped runoff coefficient



Los Angeles County Department of Public Works

RUNOFF COEFFICIENT CURVE
SOIL TYPE NO. 159

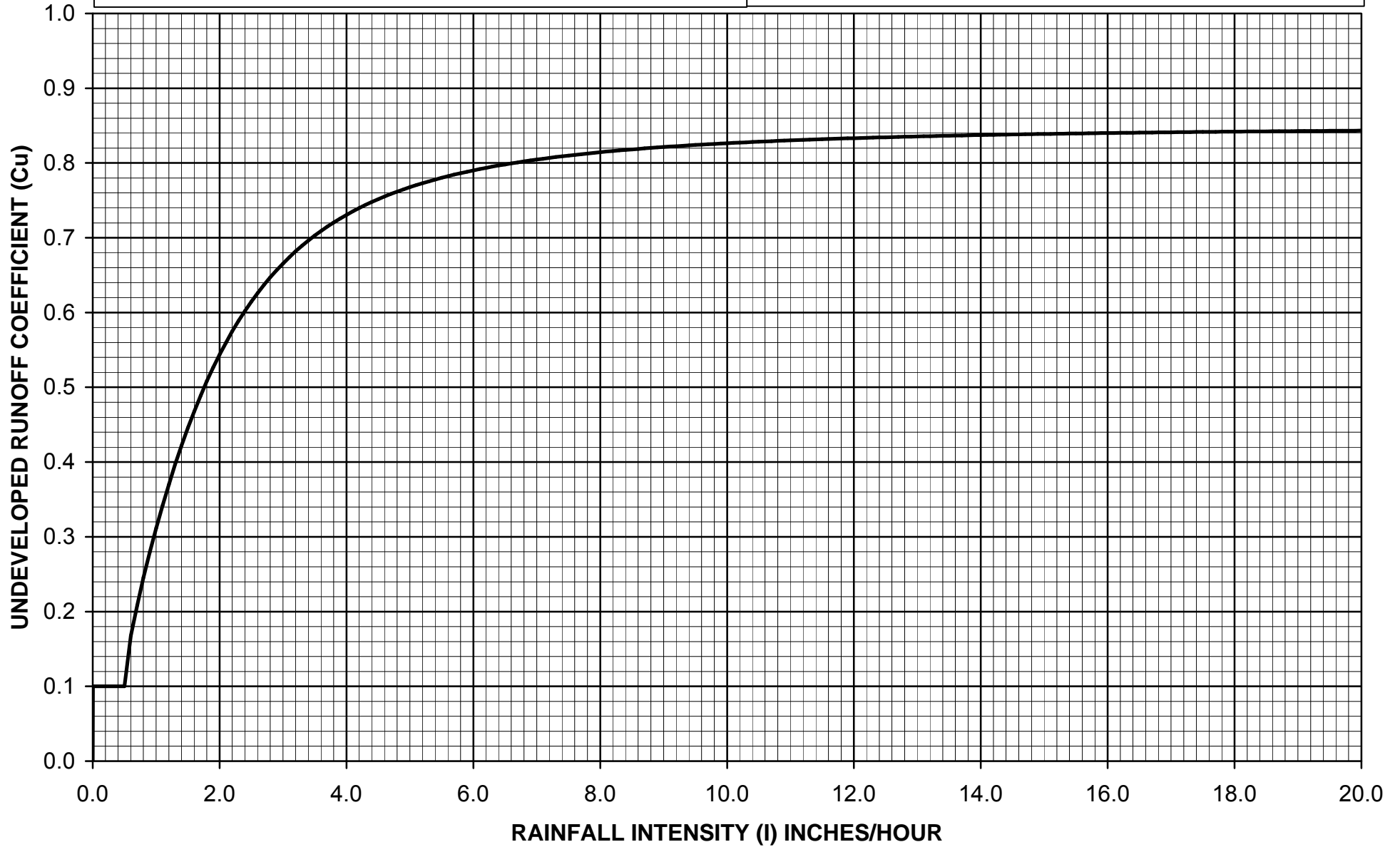

$$C_D = (0.9 * IMP) + (1.0 - IMP) * C_U$$

Where: C_D = Developed Runoff Coefficient
 IMP = Proportion Impervious
 C_U = Undeveloped runoff coefficient



Los Angeles County Department of Public Works

RUNOFF COEFFICIENT CURVE
SOIL TYPE NO. 160

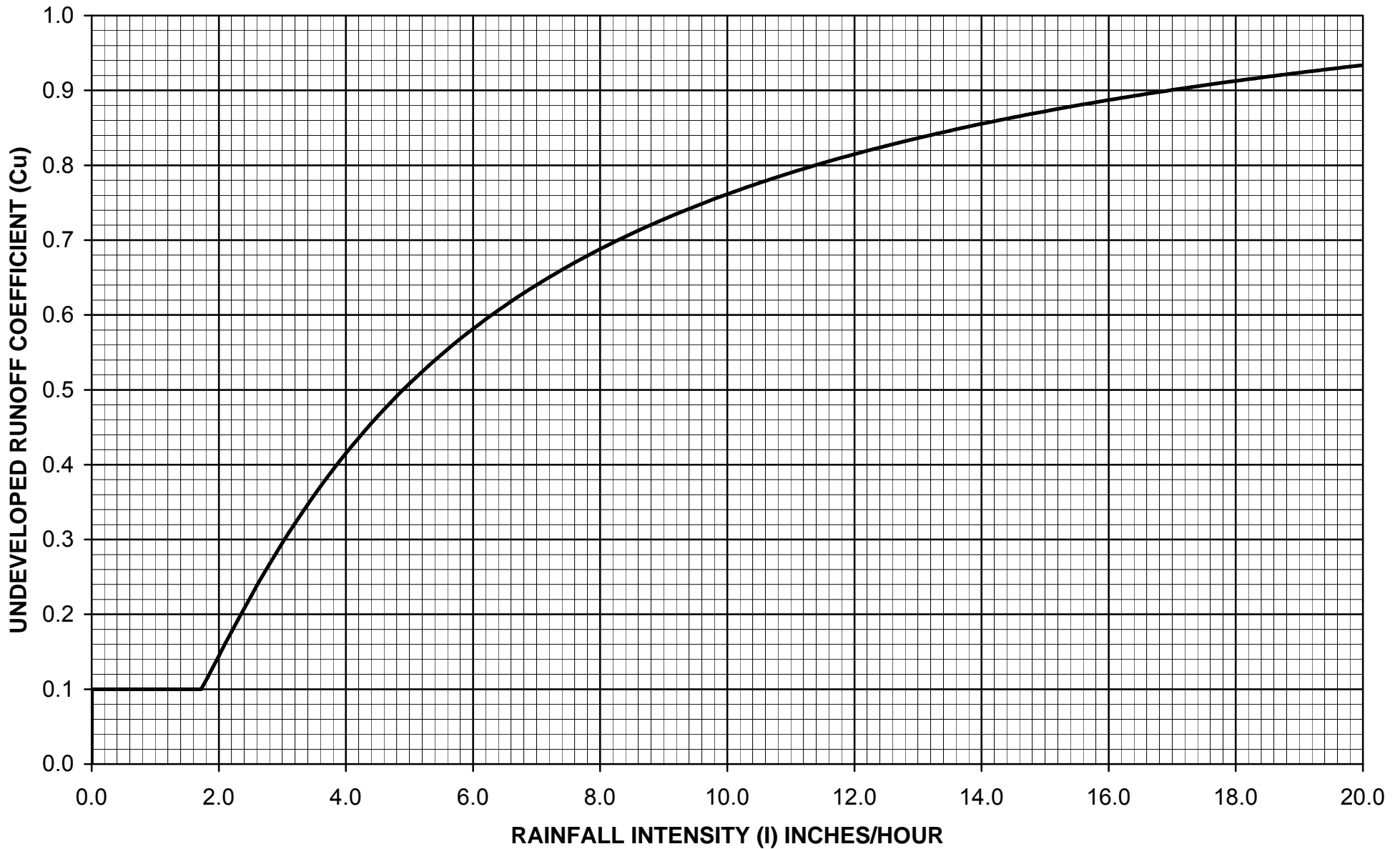

$C_D = (0.9 * IMP) + (1.0 - IMP) * C_U$
 Where: C_D = Developed Runoff Coefficient
 IMP = Proportion Impervious
 C_U = Undeveloped runoff coefficient



Los Angeles County Department of Public Works

RUNOFF COEFFICIENT CURVE
SOIL TYPE NO. 161

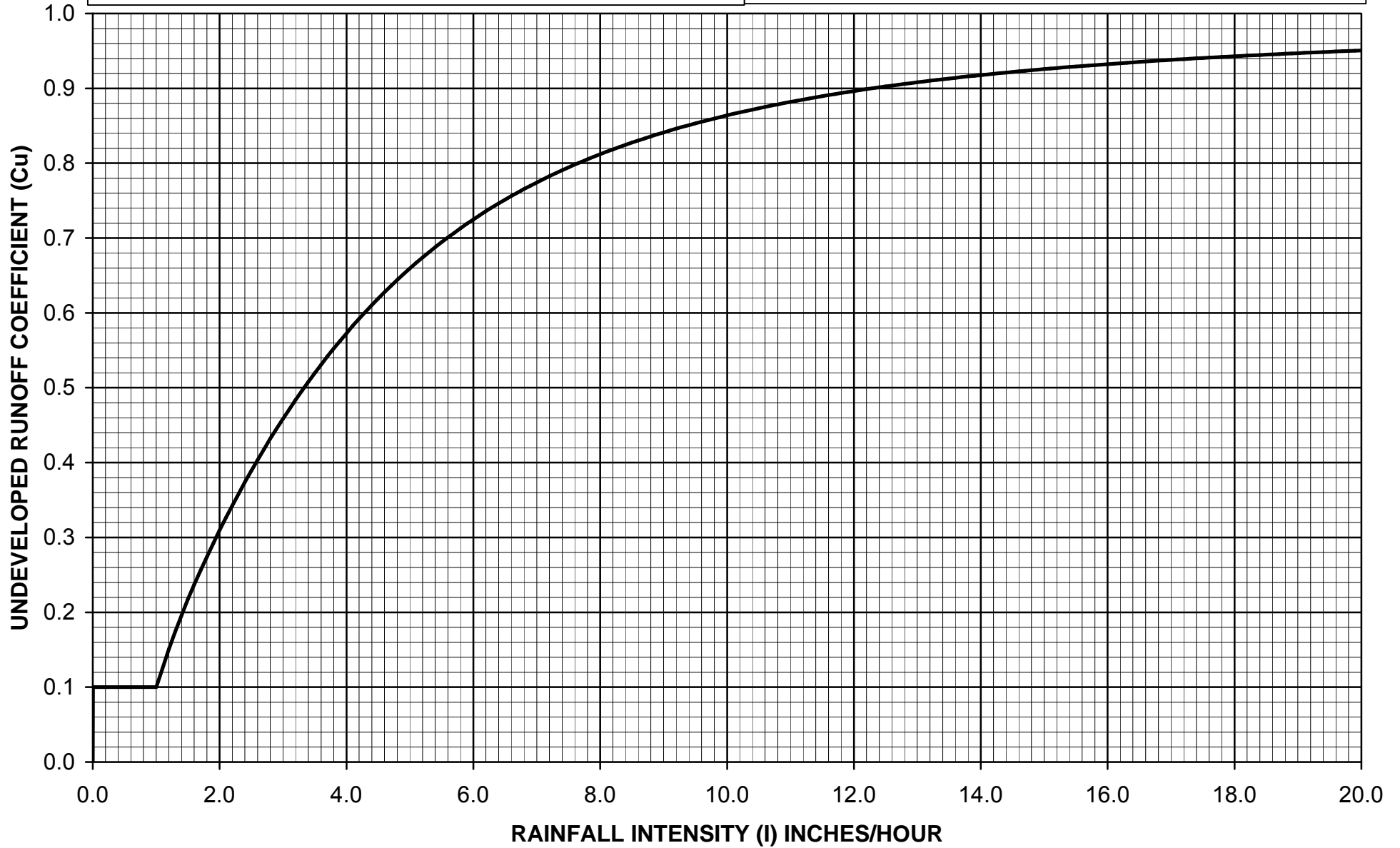

$C_D = (0.9 * IMP) + (1.0 - IMP) * C_U$
 Where: C_D = Developed Runoff Coefficient
 IMP = Proportion Impervious
 C_U = Undeveloped runoff coefficient



Los Angeles County Department of Public Works

**RUNOFF COEFFICIENT CURVE
SOIL TYPE NO. 162**

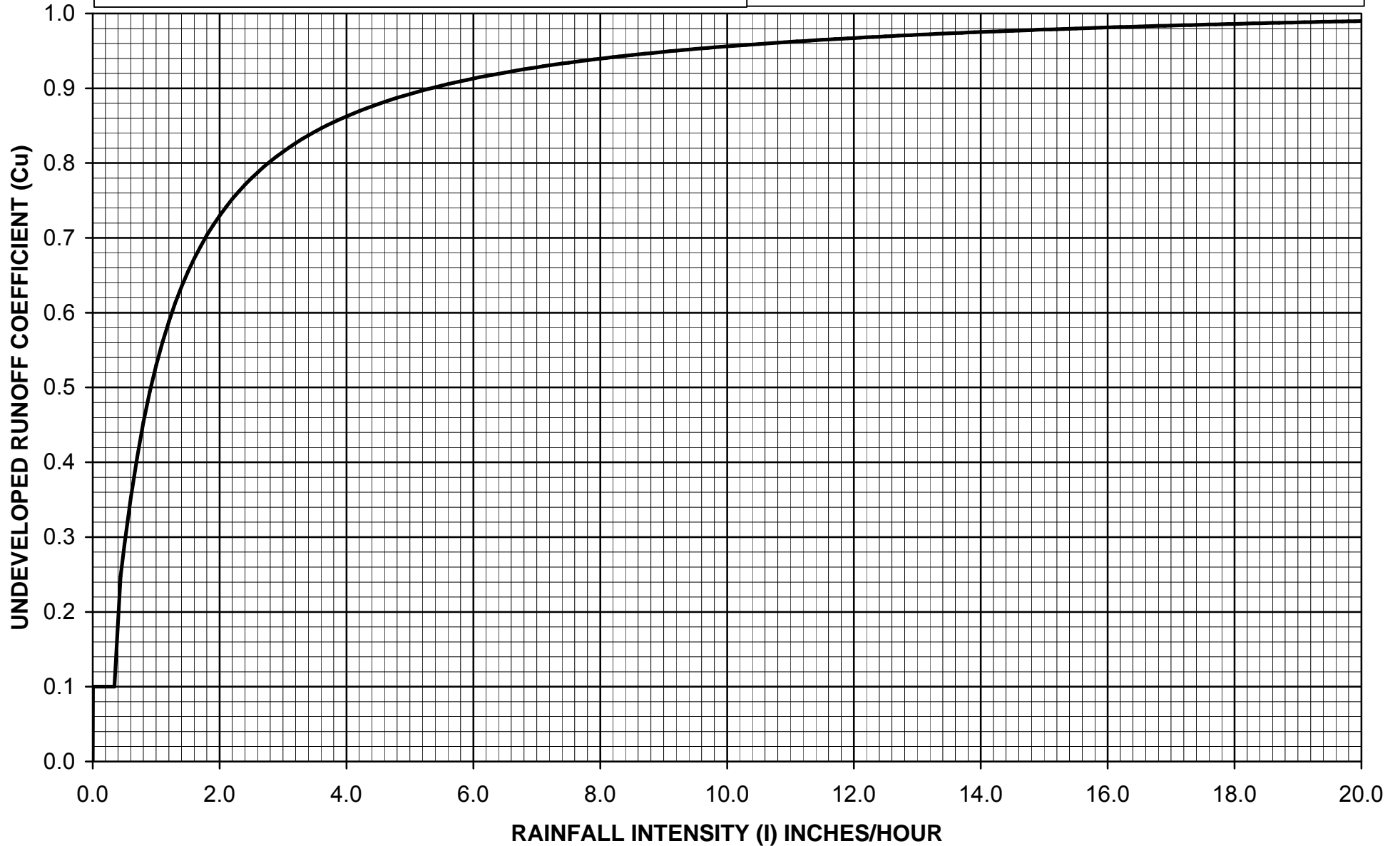

$$C_D = (0.9 * IMP) + (1.0 - IMP) * C_U$$

Where: C_D = Developed Runoff Coefficient
 IMP = Proportion Impervious
 C_U = Undeveloped runoff coefficient



Los Angeles County Department of Public Works

RUNOFF COEFFICIENT CURVE SOIL TYPE NO. 163

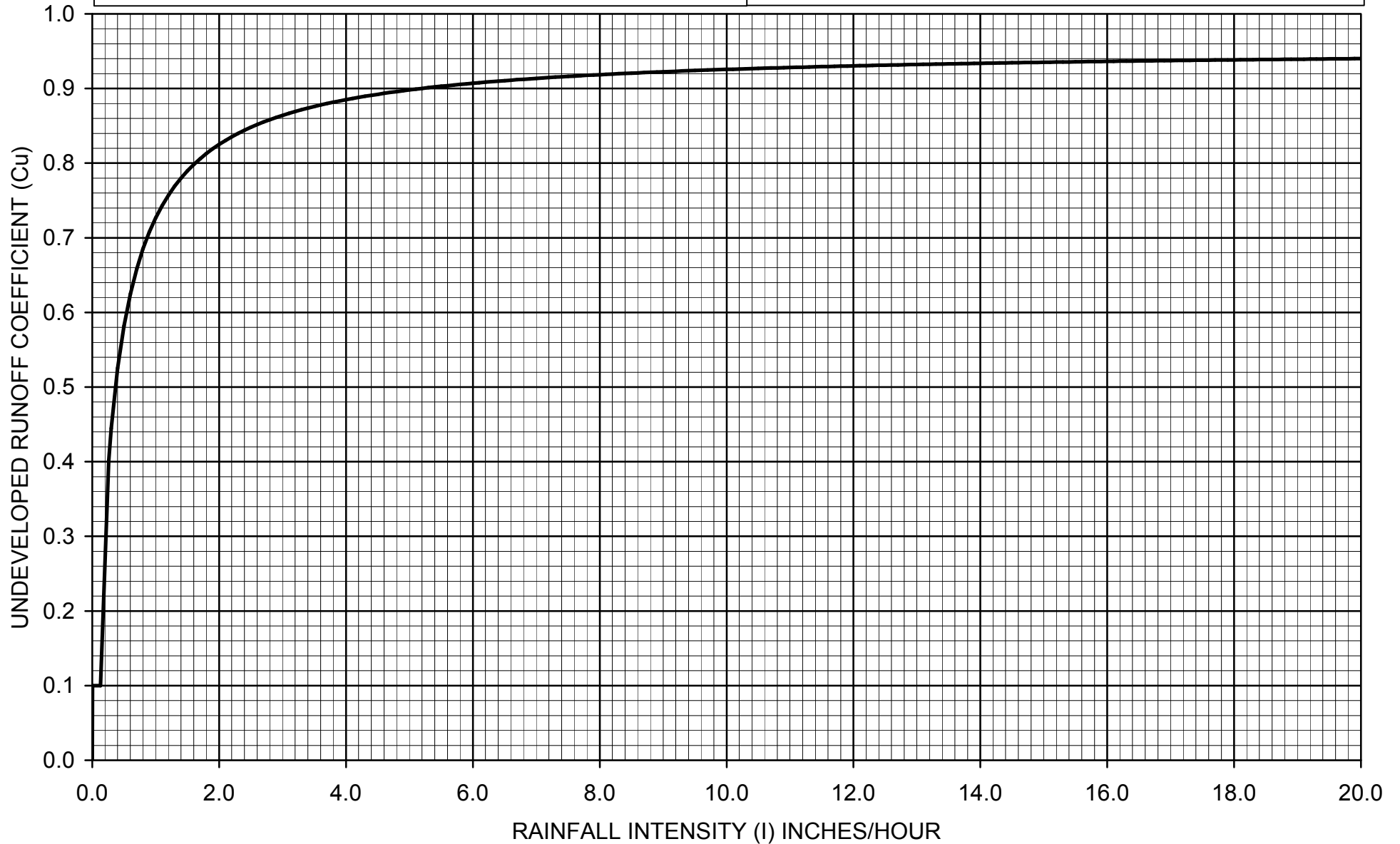

$C_D = (0.9 * IMP) + (1.0 - IMP) * C_U$
 Where: C_D = Developed Runoff Coefficient
 IMP = Proportion Impervious
 C_U = Undeveloped runoff coefficient



Los Angeles County Department of Public Works

RUNOFF COEFFICIENT CURVE
SOIL TYPE NO. 164

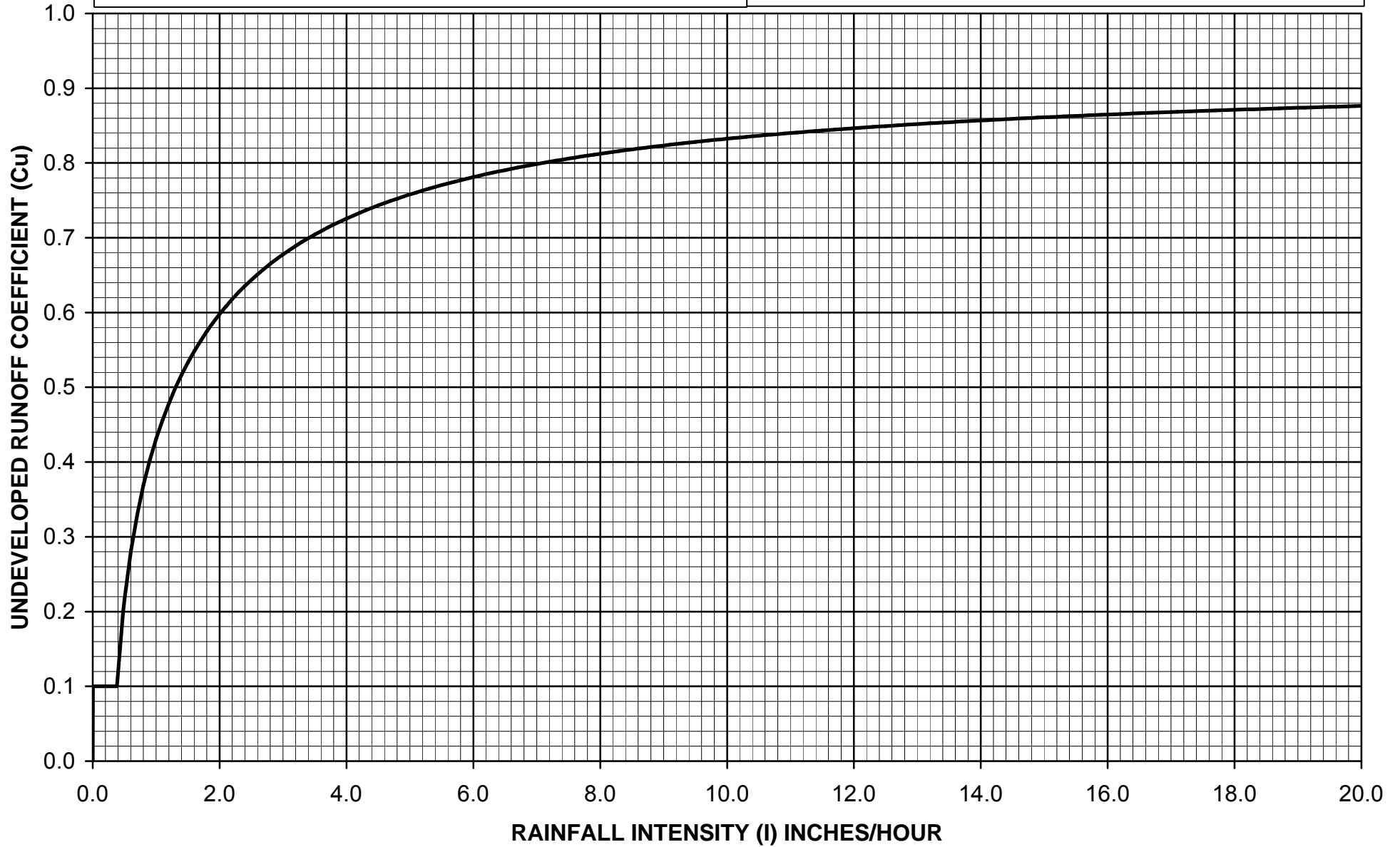

$C_D = (0.9 * IMP) + (1.0 - IMP) * C_U$
 Where: C_D = Developed Runoff Coefficient
 IMP = Proportion Impervious
 C_U = Undeveloped runoff coefficient



Los Angeles County Department of Public Works

RUNOFF COEFFICIENT CURVE
SOIL TYPE NO. 165

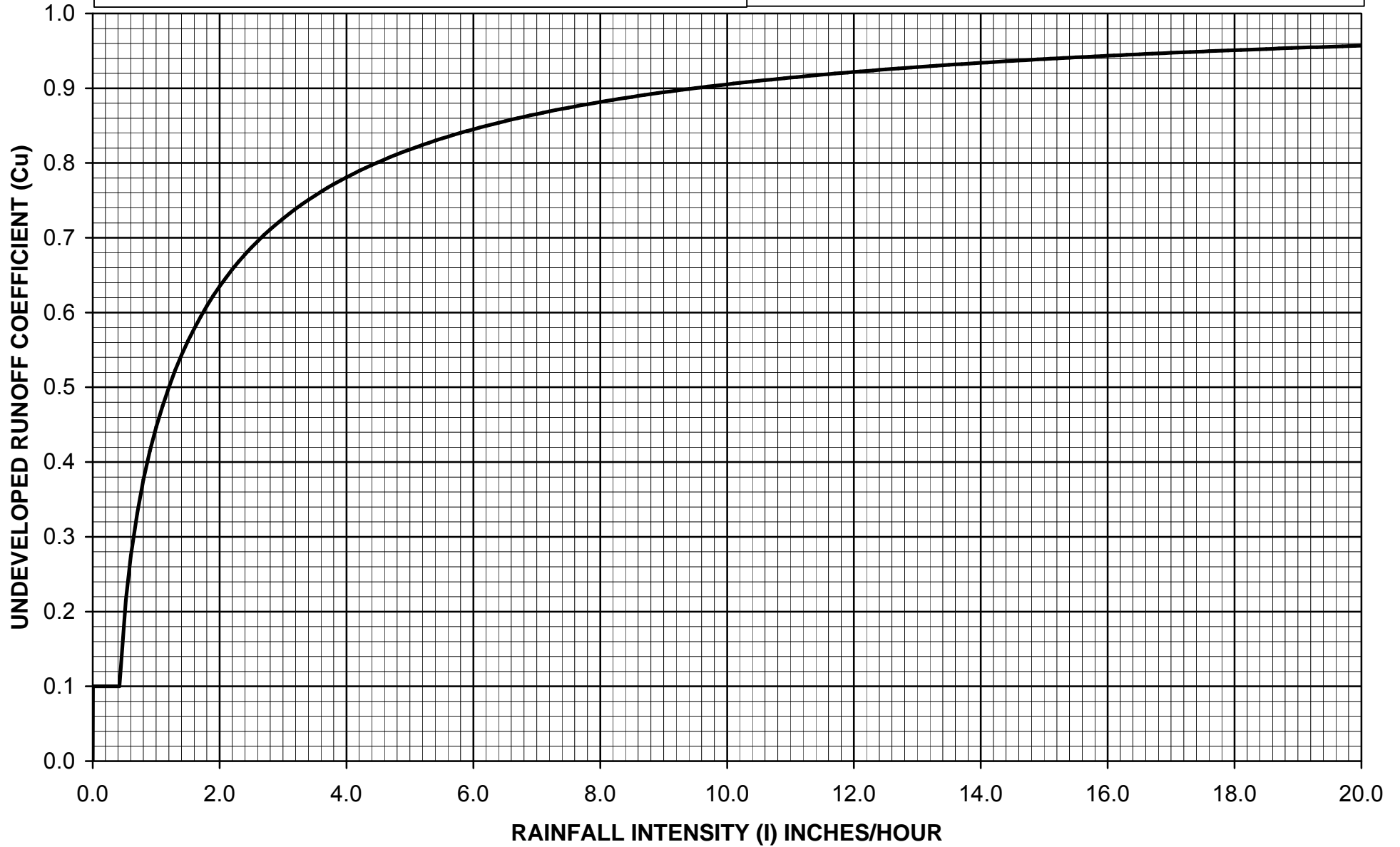

$$C_D = (0.9 * IMP) + (1.0 - IMP) * C_U$$

Where: C_D = Developed Runoff Coefficient
 IMP = Proportion Impervious
 C_U = Undeveloped runoff coefficient



Los Angeles County Department of Public Works

RUNOFF COEFFICIENT CURVE
SOIL TYPE NO. 166

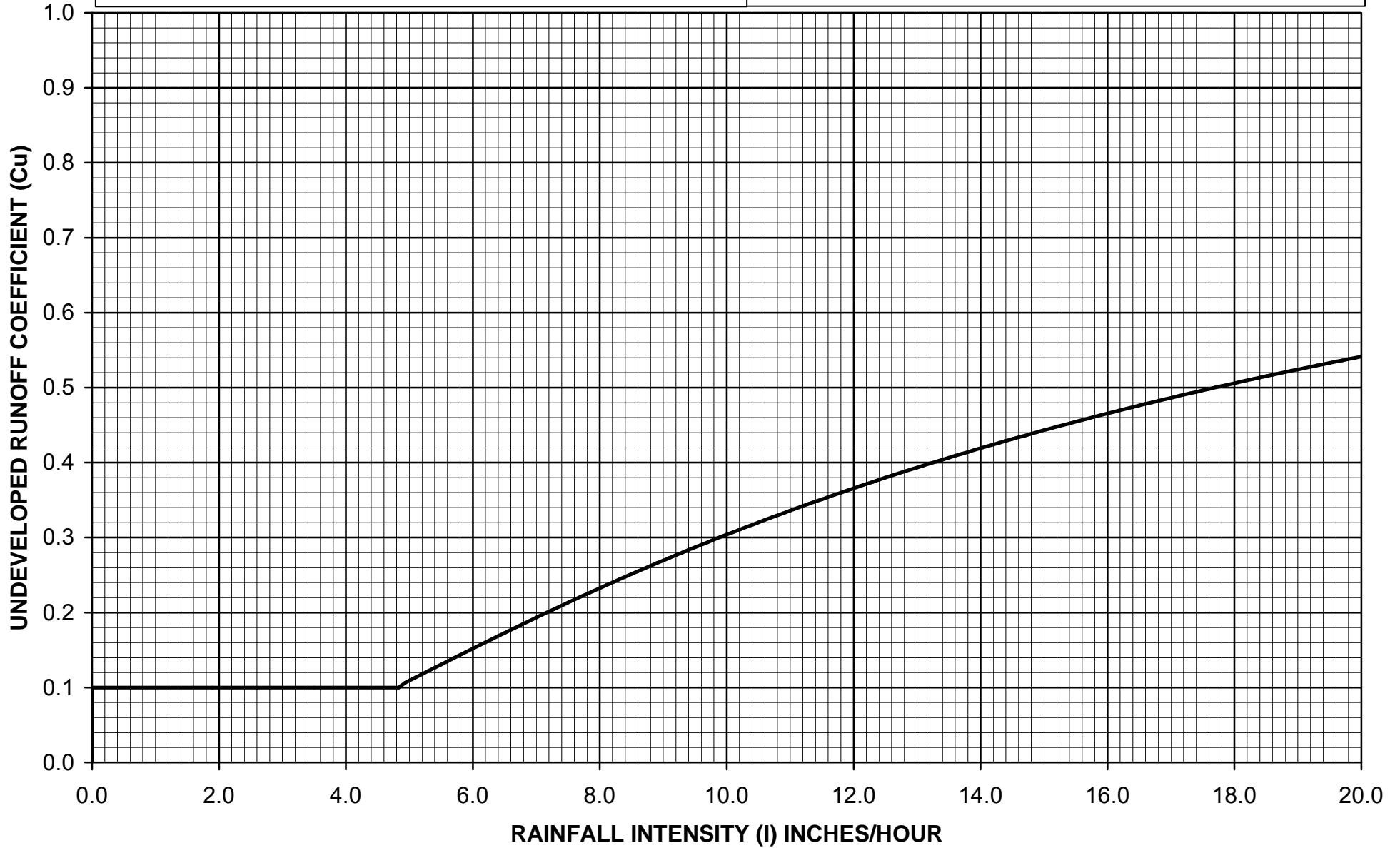

$C_D = (0.9 * IMP) + (1.0 - IMP) * C_U$
 Where: C_D = Developed Runoff Coefficient
 IMP = Proportion Impervious
 C_U = Undeveloped runoff coefficient



Los Angeles County Department of Public Works

RUNOFF COEFFICIENT CURVE
SOIL TYPE NO. 167

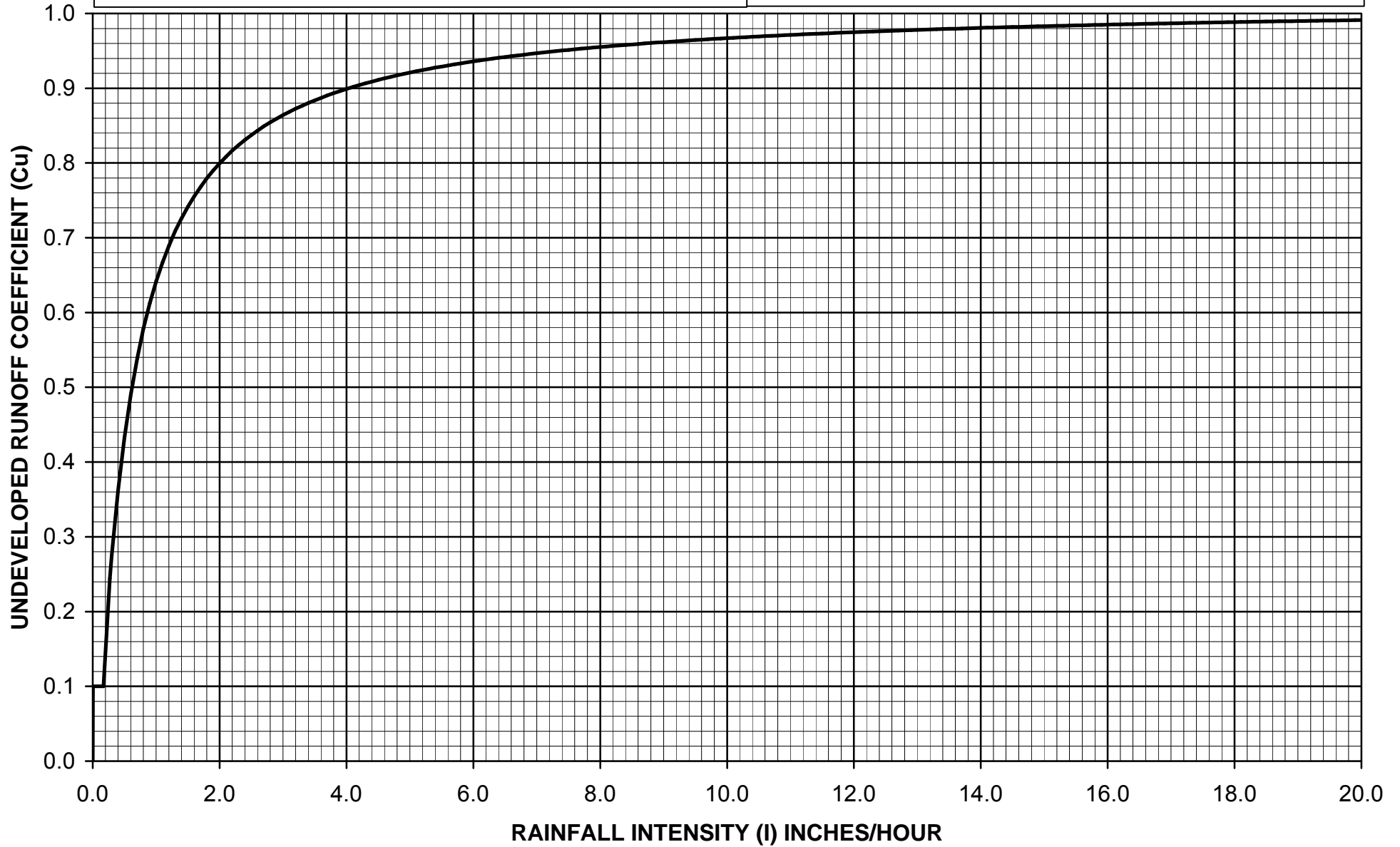

$$C_D = (0.9 * IMP) + (1.0 - IMP) * C_U$$

Where: C_D = Developed Runoff Coefficient
 IMP = Proportion Impervious
 C_U = Undeveloped runoff coefficient



Los Angeles County Department of Public Works

RUNOFF COEFFICIENT CURVE
SOIL TYPE NO. 168

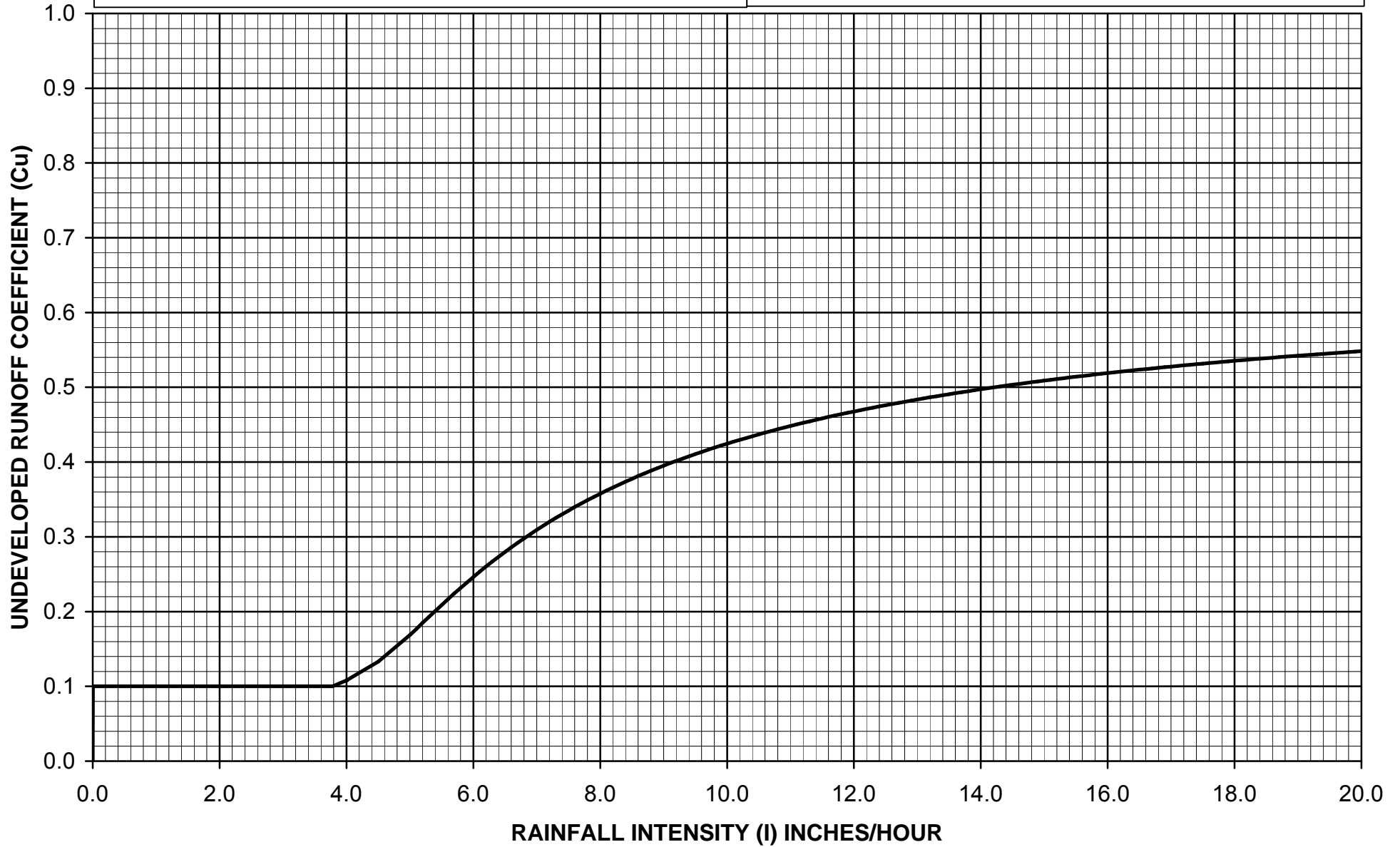

$$C_D = (0.9 * IMP) + (1.0 - IMP) * C_U$$

Where: C_D = Developed Runoff Coefficient
 IMP = Proportion Impervious
 C_U = Undeveloped runoff coefficient



Los Angeles County Department of Public Works

RUNOFF COEFFICIENT CURVE
SOIL TYPE NO. 169

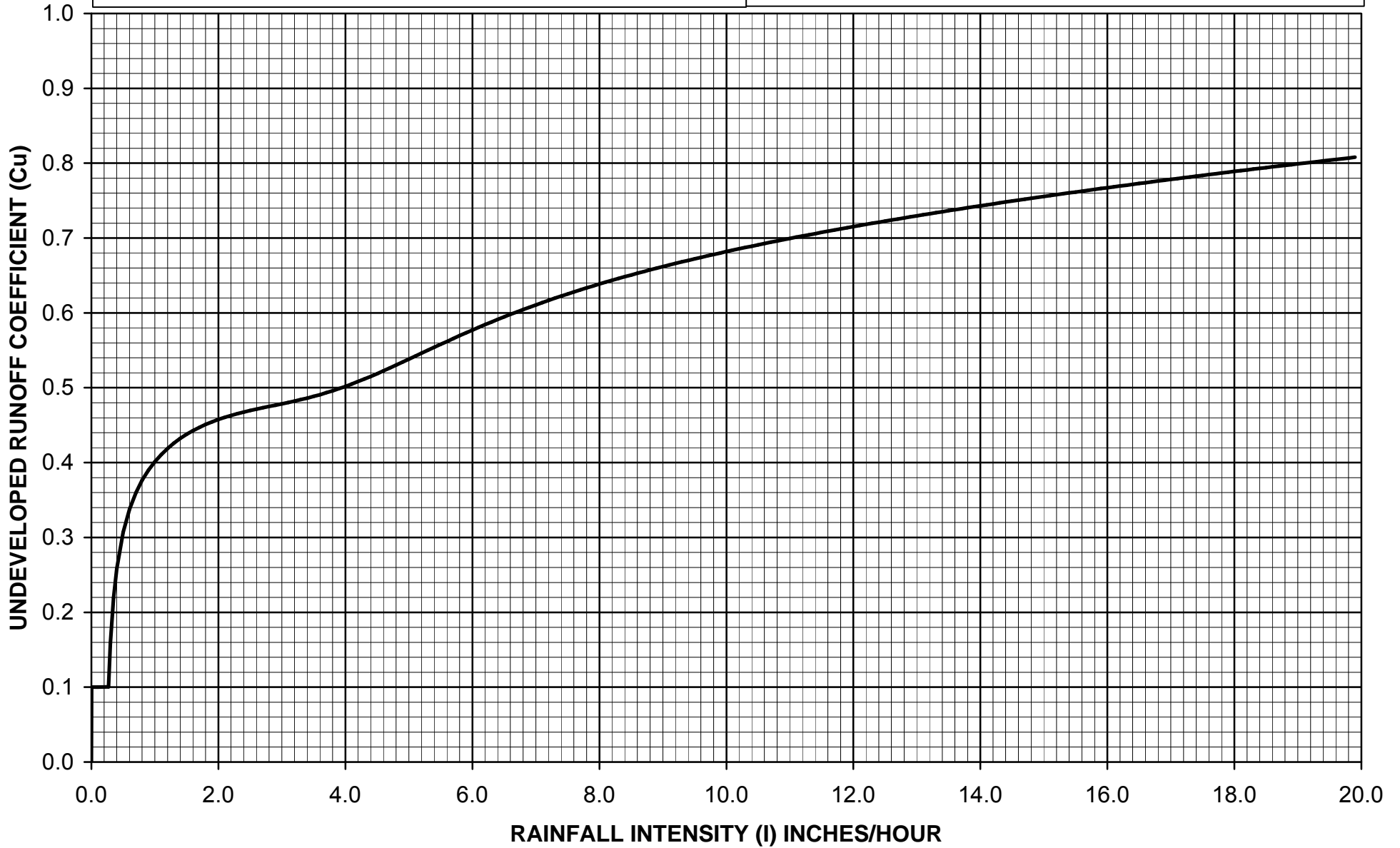

$C_D = (0.9 * IMP) + (1.0 - IMP) * C_U$
 Where: C_D = Developed Runoff Coefficient
 IMP = Proportion Impervious
 C_U = Undeveloped runoff coefficient



Los Angeles County Department of Public Works

**RUNOFF COEFFICIENT CURVE
SOIL TYPE NO. 170**

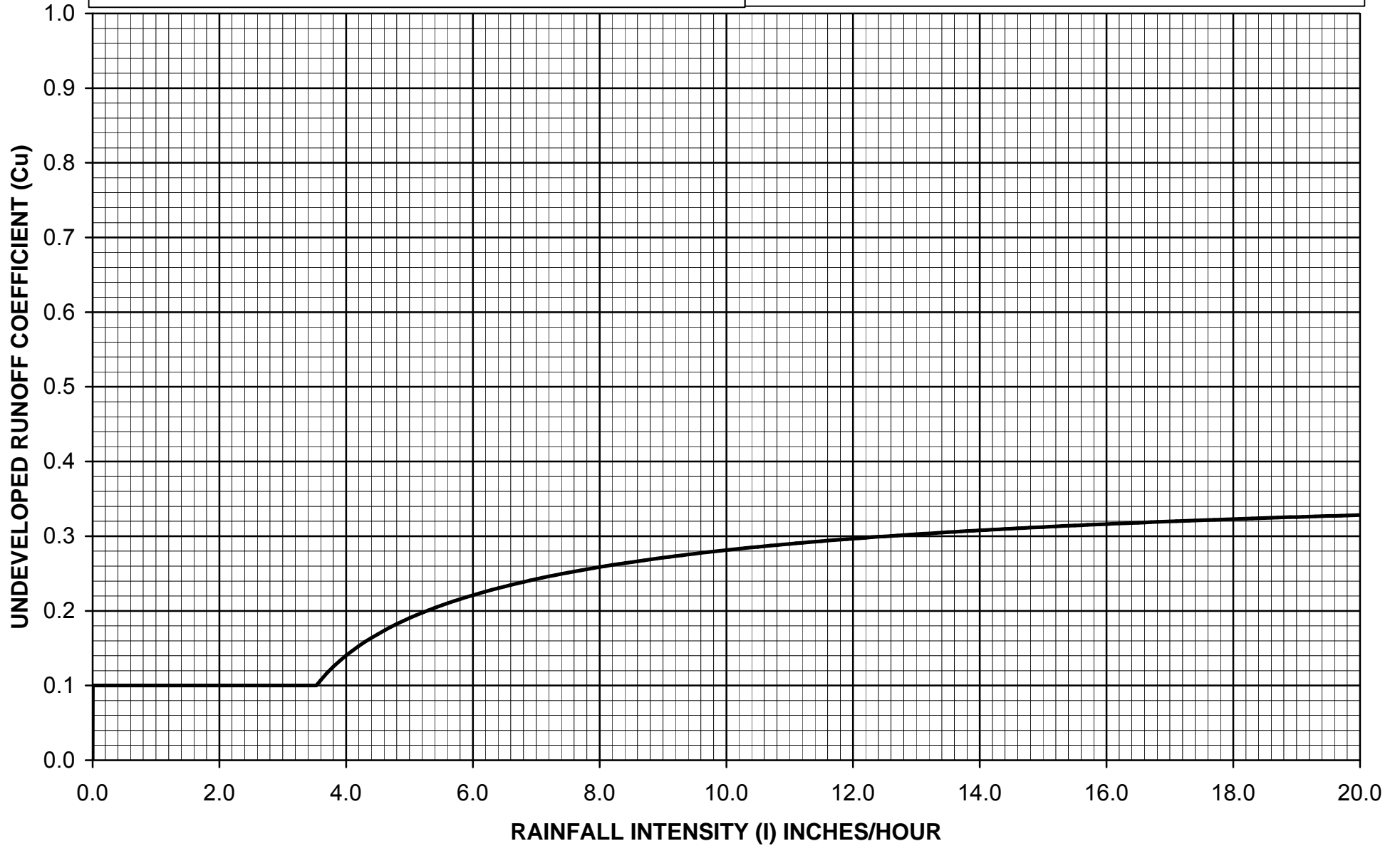

$C_D = (0.9 * IMP) + (1.0 - IMP) * C_U$
 Where: C_D = Developed Runoff Coefficient
 IMP = Proportion Impervious
 C_U = Undeveloped runoff coefficient



Los Angeles County Department of Public Works

**RUNOFF COEFFICIENT CURVE
SOIL TYPE NO. 171**

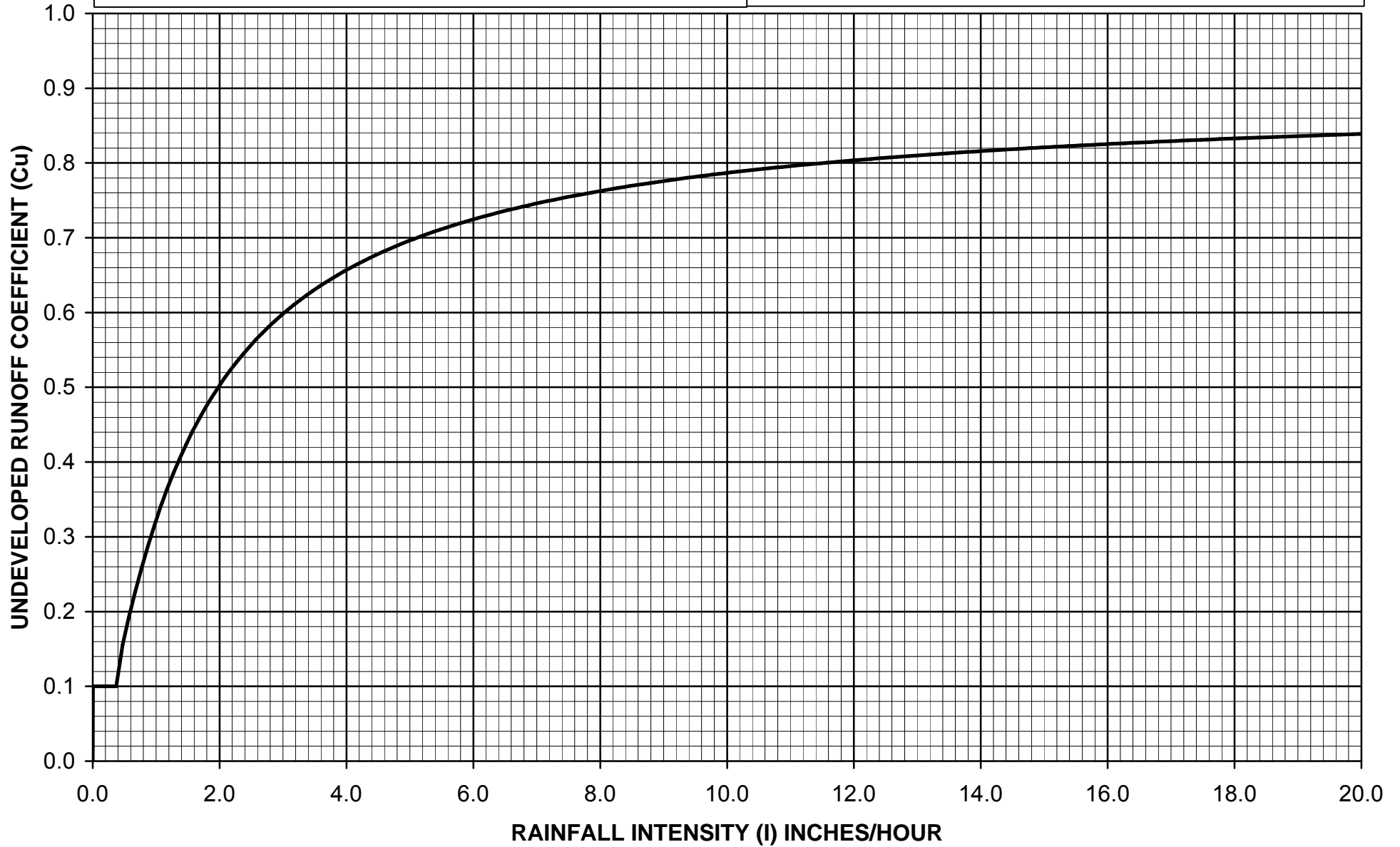

$C_D = (0.9 * IMP) + (1.0 - IMP) * C_U$
 Where: C_D = Developed Runoff Coefficient
 IMP = Proportion Impervious
 C_U = Undeveloped runoff coefficient



Los Angeles County Department of Public Works

RUNOFF COEFFICIENT CURVE
SOIL TYPE NO. 172

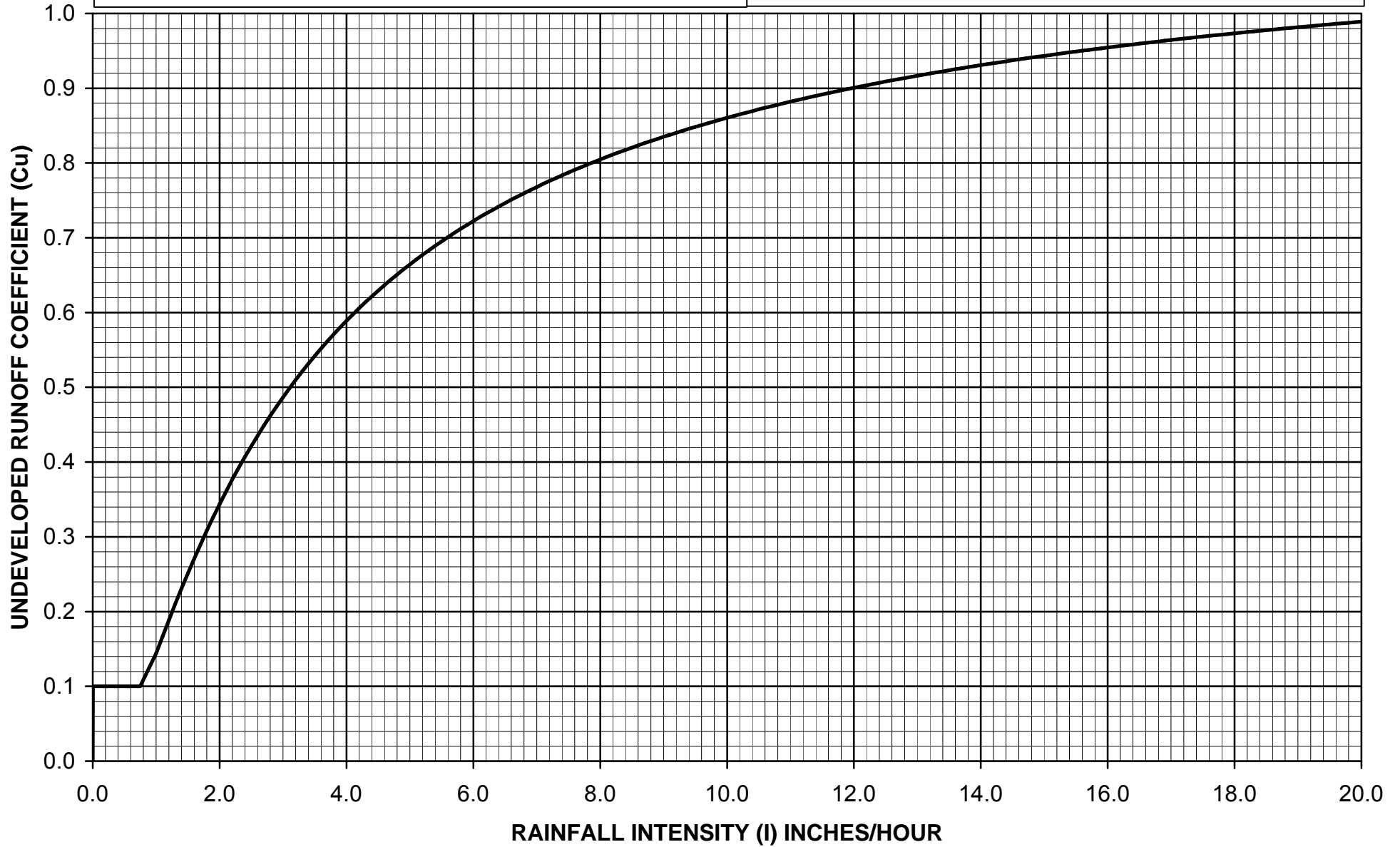

$C_D = (0.9 * IMP) + (1.0 - IMP) * C_U$
 Where: C_D = Developed Runoff Coefficient
 IMP = Proportion Impervious
 C_U = Undeveloped runoff coefficient



Los Angeles County Department of Public Works

RUNOFF COEFFICIENT CURVE
SOIL TYPE NO. 173

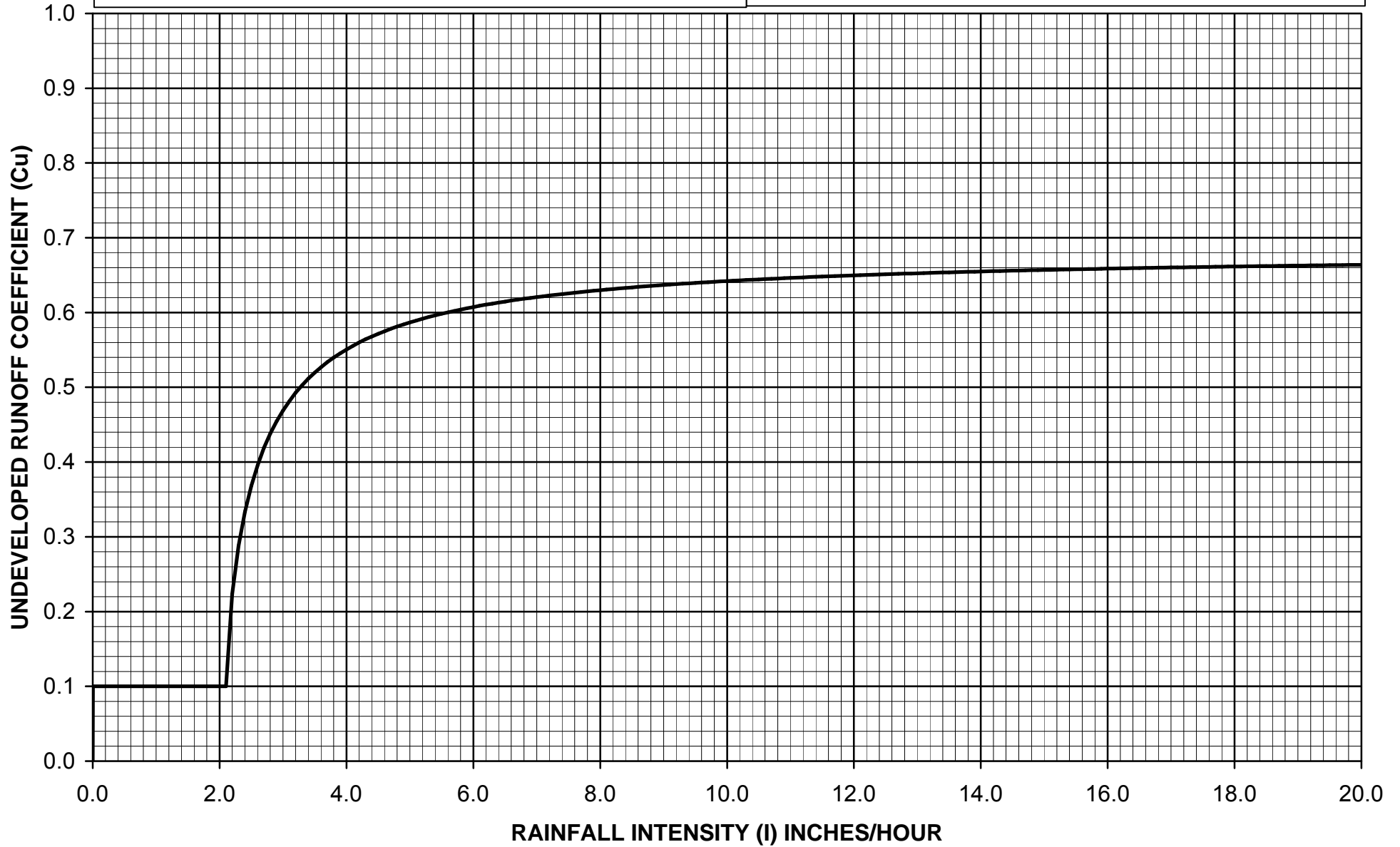

$$C_D = (0.9 * IMP) + (1.0 - IMP) * C_U$$

Where: C_D = Developed Runoff Coefficient

IMP = Proportion Impervious

C_U = Undeveloped runoff coefficient



Los Angeles County Department of Public Works

RUNOFF COEFFICIENT CURVE
SOIL TYPE NO. 174

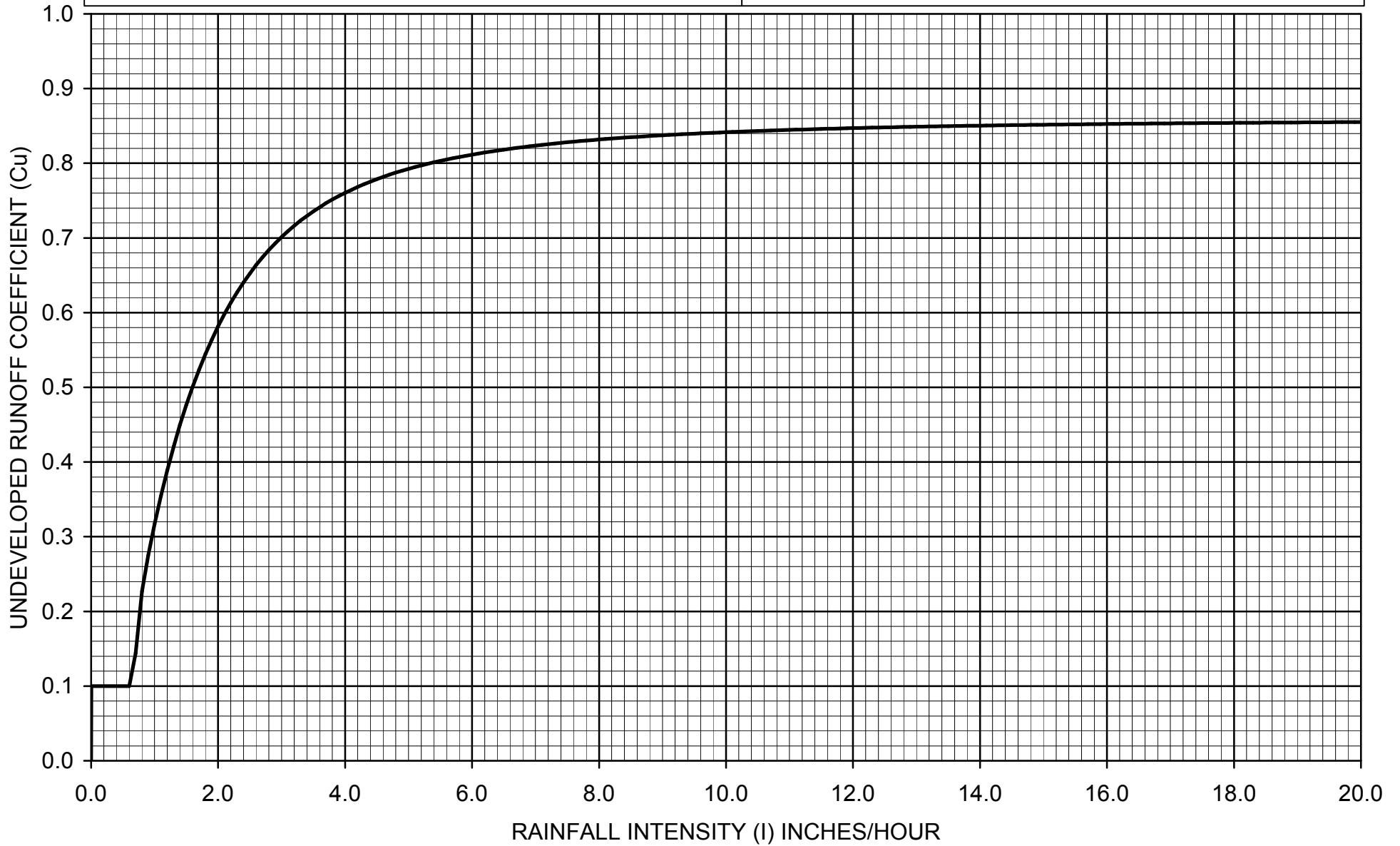

$C_D = (0.9 * IMP) + (1.0 - IMP) * C_U$
 Where: C_D = Developed Runoff Coefficient
 IMP = Proportion Impervious
 C_U = Undeveloped runoff coefficient



Los Angeles County Department of Public Works

RUNOFF COEFFICIENT CURVE
SOIL TYPE NO. 175

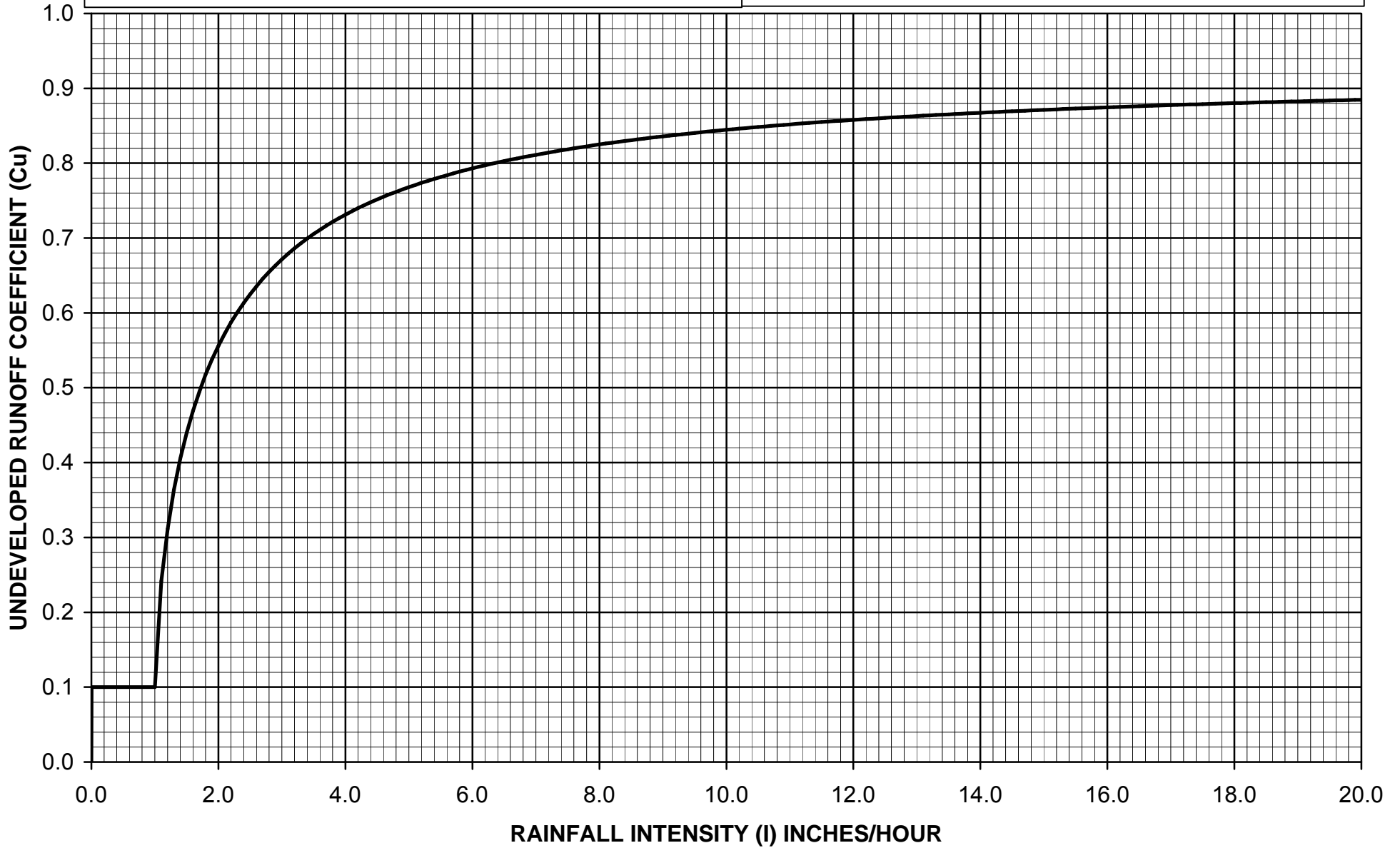

$$C_D = (0.9 * IMP) + (1.0 - IMP) * C_U$$

Where: C_D = Developed Runoff Coefficient

IMP = Proportion Impervious

C_U = Undeveloped runoff coefficient



Los Angeles County Department of Public Works

RUNOFF COEFFICIENT CURVE
SOIL TYPE NO. 176

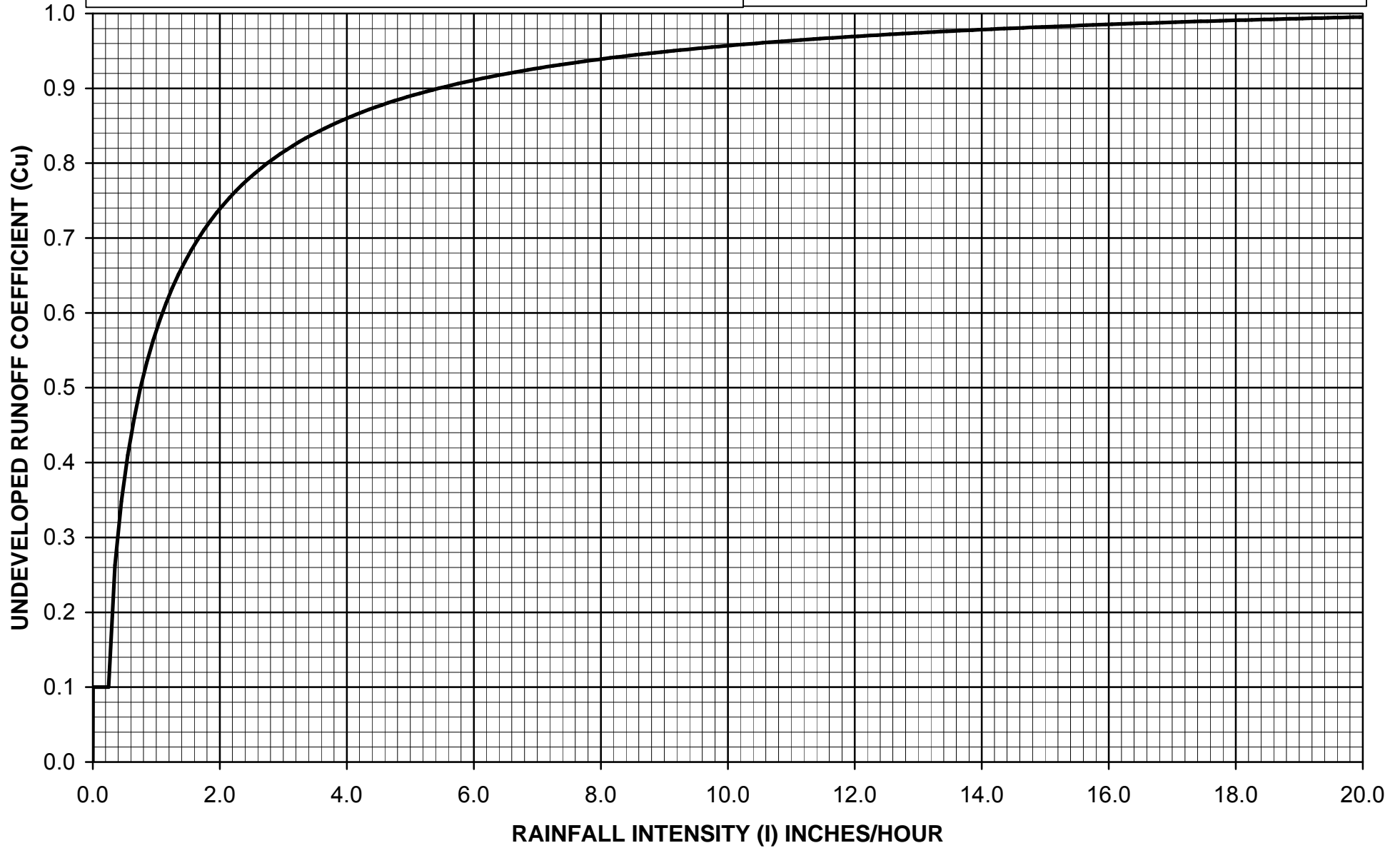

$$C_D = (0.9 * IMP) + (1.0 - IMP) * C_U$$

Where: C_D = Developed Runoff Coefficient

IMP = Proportion Impervious

C_U = Undeveloped runoff coefficient



Los Angeles County Department of Public Works

**RUNOFF COEFFICIENT CURVE
SOIL TYPE NO. 177**

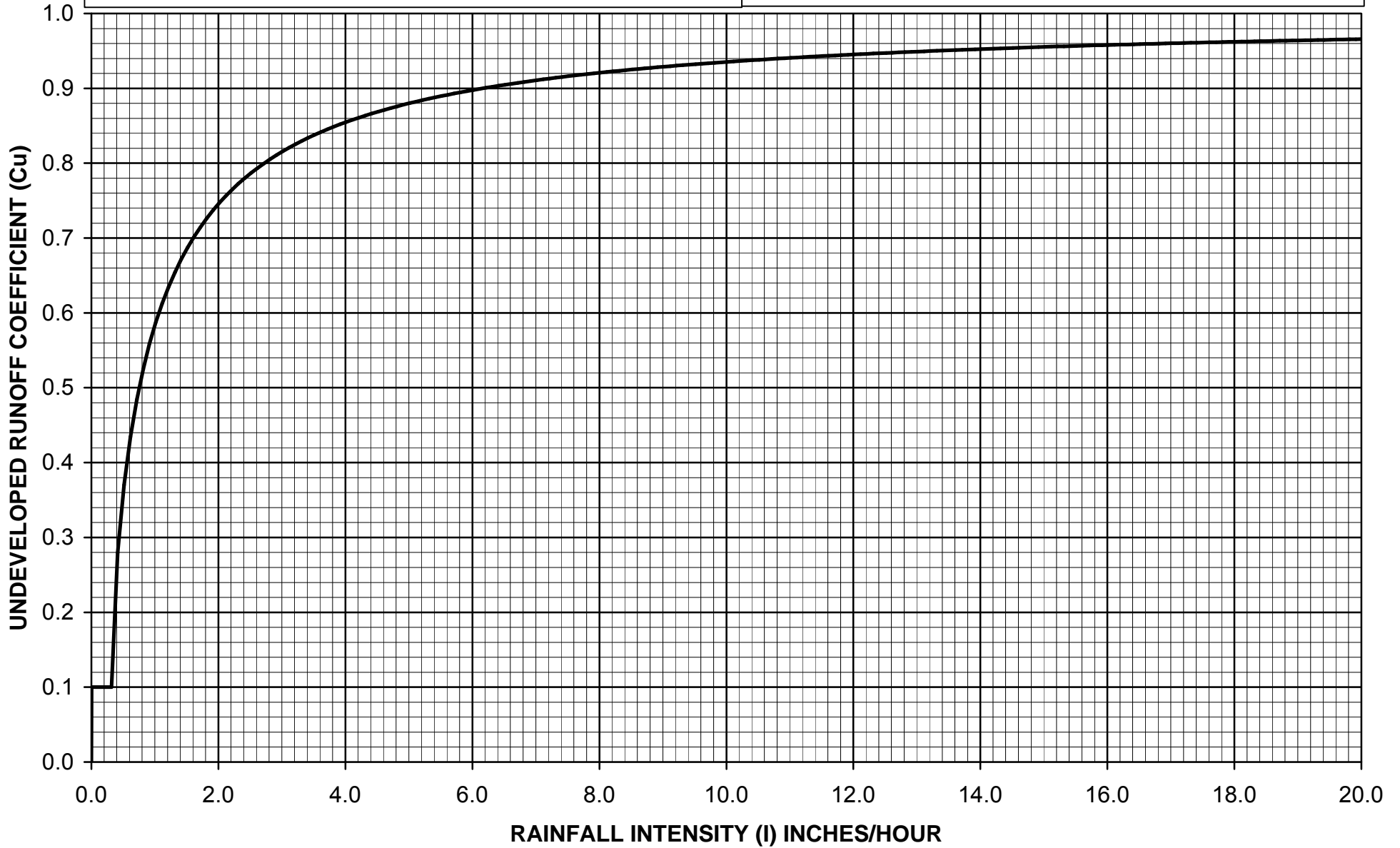

$$C_D = (0.9 * IMP) + (1.0 - IMP) * C_U$$

Where: C_D = Developed Runoff Coefficient

IMP = Proportion Impervious

C_U = Undeveloped runoff coefficient



Los Angeles County Department of Public Works

**RUNOFF COEFFICIENT CURVE
SOIL TYPE NO. 178**

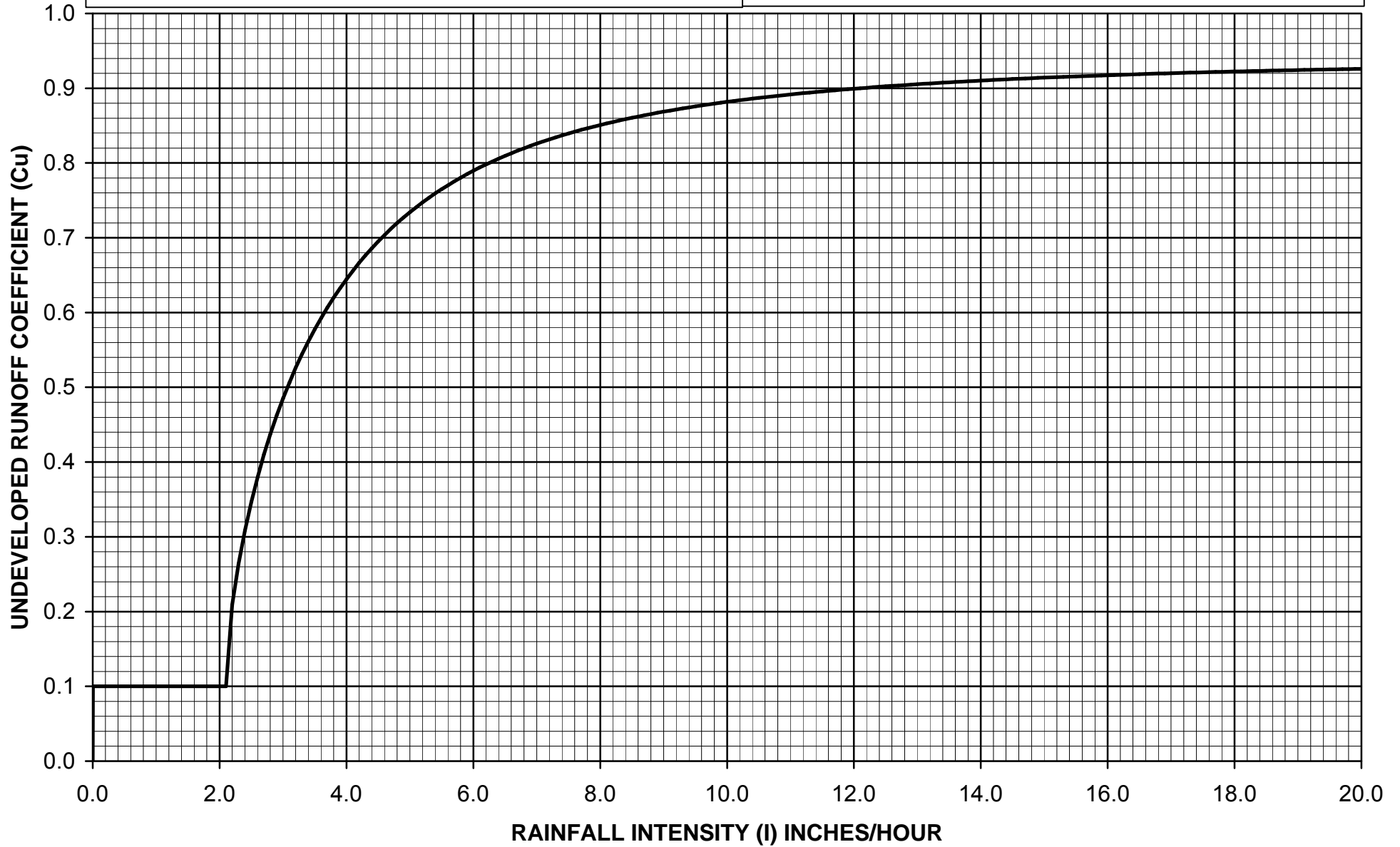

$$C_D = (0.9 * IMP) + (1.0 - IMP) * C_U$$

Where: C_D = Developed Runoff Coefficient

IMP = Proportion Impervious

C_U = Undeveloped runoff coefficient



Los Angeles County Department of Public Works

RUNOFF COEFFICIENT CURVE
SOIL TYPE NO. 179

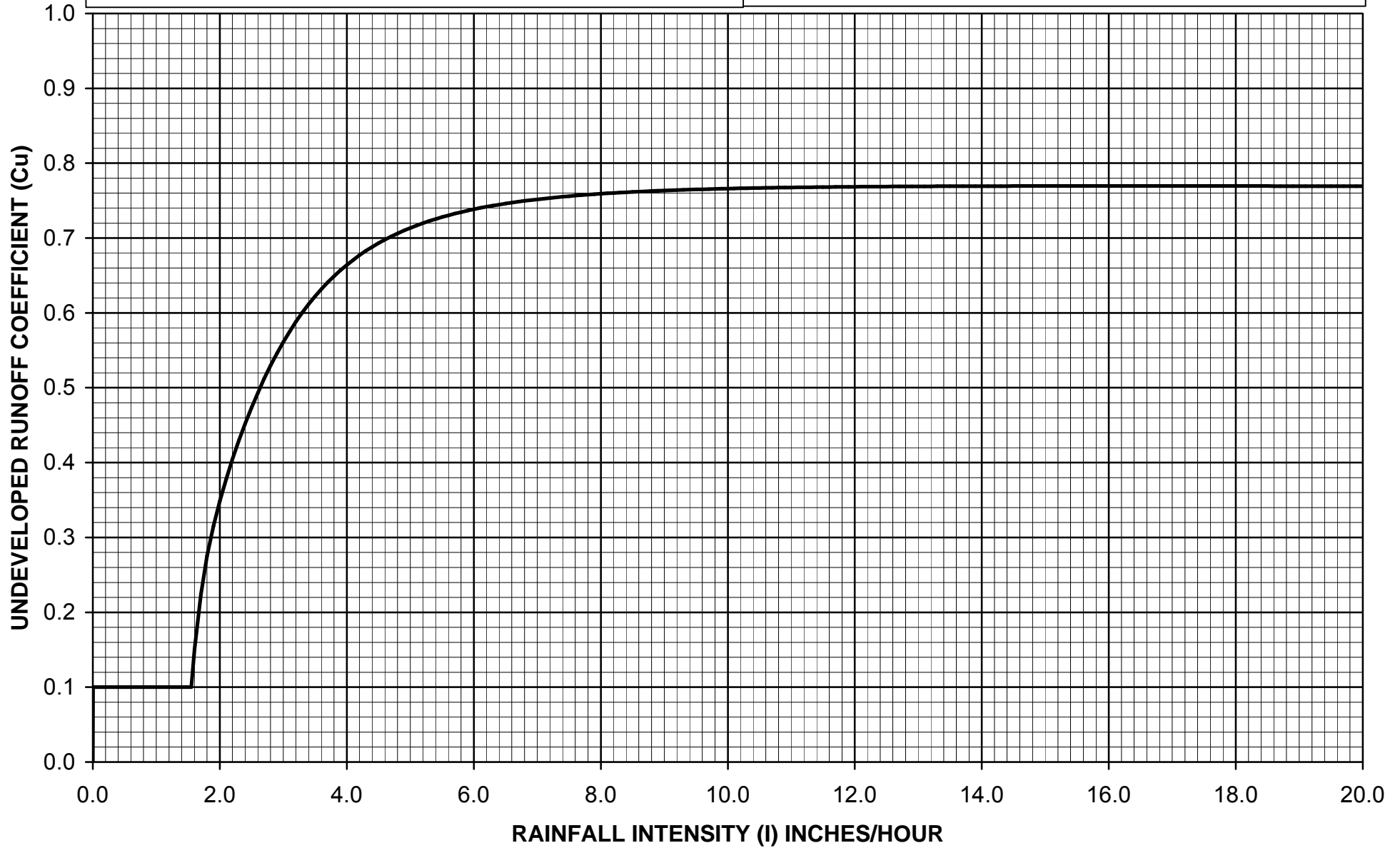

$C_D = (0.9 * IMP) + (1.0 - IMP) * C_U$
 Where: C_D = Developed Runoff Coefficient
 IMP = Proportion Impervious
 C_U = Undeveloped runoff coefficient



Los Angeles County Department of Public Works

**RUNOFF COEFFICIENT CURVE
SOIL TYPE NO. 180**

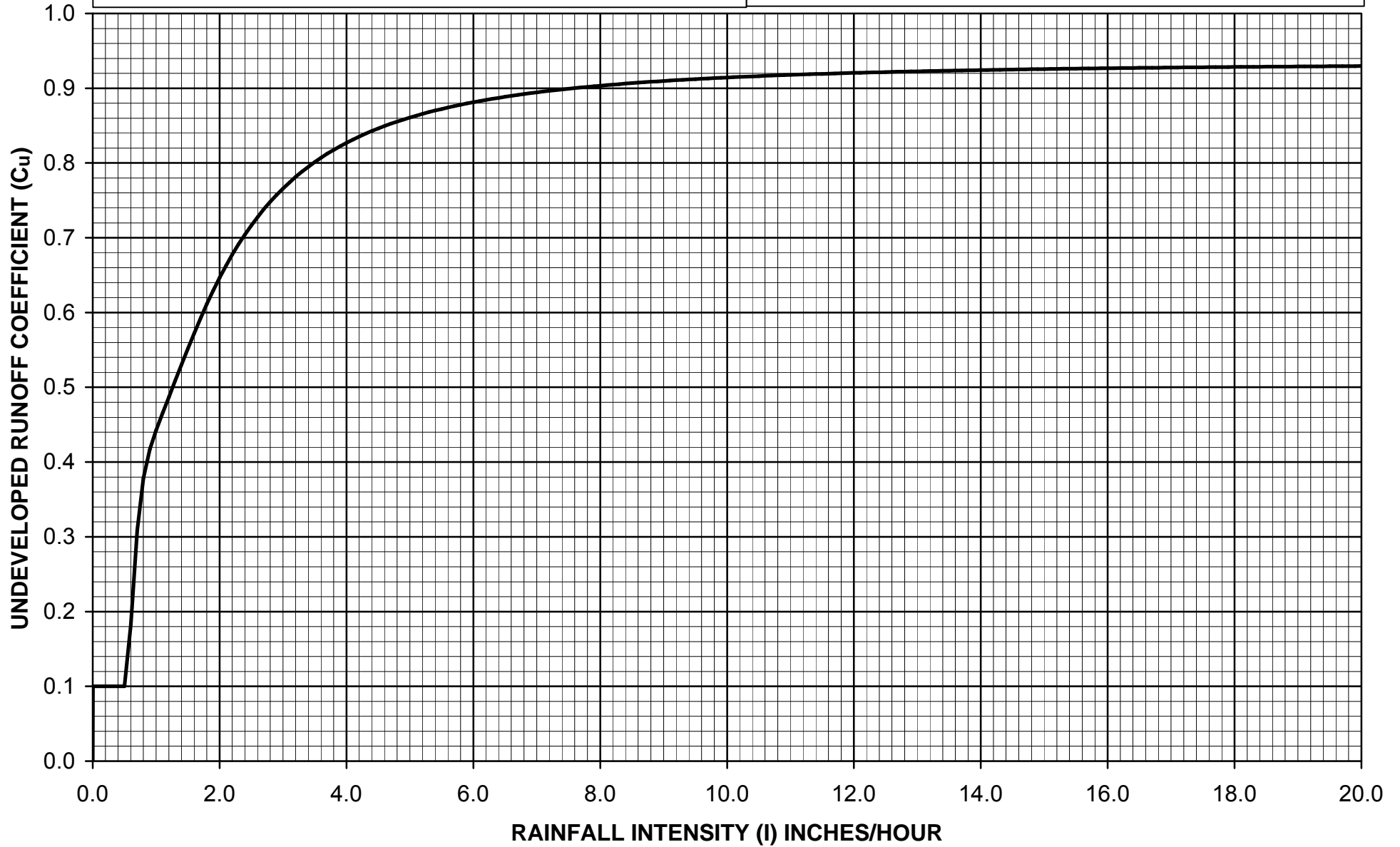

APPENDIX **D**

Source Control Measure Fact Sheets

Appendix D – Source Control Measure Fact Sheets

Table of Contents

S-1: Storm Drain Message and Signage	D-1
S-2: Outdoor Material Storage Area	D-3
S-3: Outdoor Trash Storage and Waste Handling Area	D-8
S-4: Outdoor Loading/Unloading Dock Area	D-10
S-5: Outdoor Vehicle/Equipment Repair/Maintenance Area	D-12
S-6: Outdoor Vehicle/Equipment/Accessory Washing Area	D-14
S-7: Fuel and Maintenance Area.....	D-16
S-8: Landscape Irrigation Practices	D-19
S-9: Building Materials Selection.....	D-21
S-10: Animal Care and Handling Facilities	D-23
S-11: Outdoor Horticulture Areas	D-25

S-1: Storm Drain Message and Signage

Purpose

Waste material dumped into storm drain inlets can adversely impact surface and ground waters. In fact, any material discharged into the storm drain system has the potential to significantly impact downstream receiving waters. Storm drain messages have become a popular method of alerting and reminding the public about the effects of and the prohibitions against waste disposal into the storm drain system. The signs are typically stenciled or affixed near the storm drain inlet or catch basin. The message simply informs the public that dumping of wastes into storm drain inlets is prohibited and/or that the drain ultimately discharges into receiving waters.

General Guidance

- The signs must be placed so they are easily visible to the public.
- Be aware that signs placed on sidewalk will be worn by foot traffic.

Design Specifications

- Signs with language and/or graphical icons that prohibit illegal dumping, must be posted at designated public access points along channels and streams within the project area. Consult with Los Angeles County Department of Public Works (LACDPW) staff to determine specific signage requirements for channels and streams.
- Storm drain message markers, placards, concrete stamps, or stenciled language/icons (e.g., “No Dumping – Drains to the Ocean”) are required at all storm drain inlets and catch basins within the project area to discourage illegal or inadvertent dumping. Signs should be placed in clear sight facing anyone approaching the storm drain inlet or catch basin from either side (see Figure D-1 and Figure D-2). LACDPW staff should be contacted to determine specific requirements for types of signs and methods of application. A stencil can be purchased for a nominal fee from LACDPW Building and Safety Office by calling (626) 458-3171. All storm drain inlet and catch basin locations must be identified on the project site map.

Maintenance Requirements

Legibility and visibility of markers and signs should be maintained (e.g., signs should be repainted or replaced as necessary). If required by LACDPW, the owner/operator or homeowner’s association shall enter into a maintenance agreement with the agency or record a deed restriction upon the property title to maintain the legibility of placards and signs.

S-1: Storm Drain Message and Signage

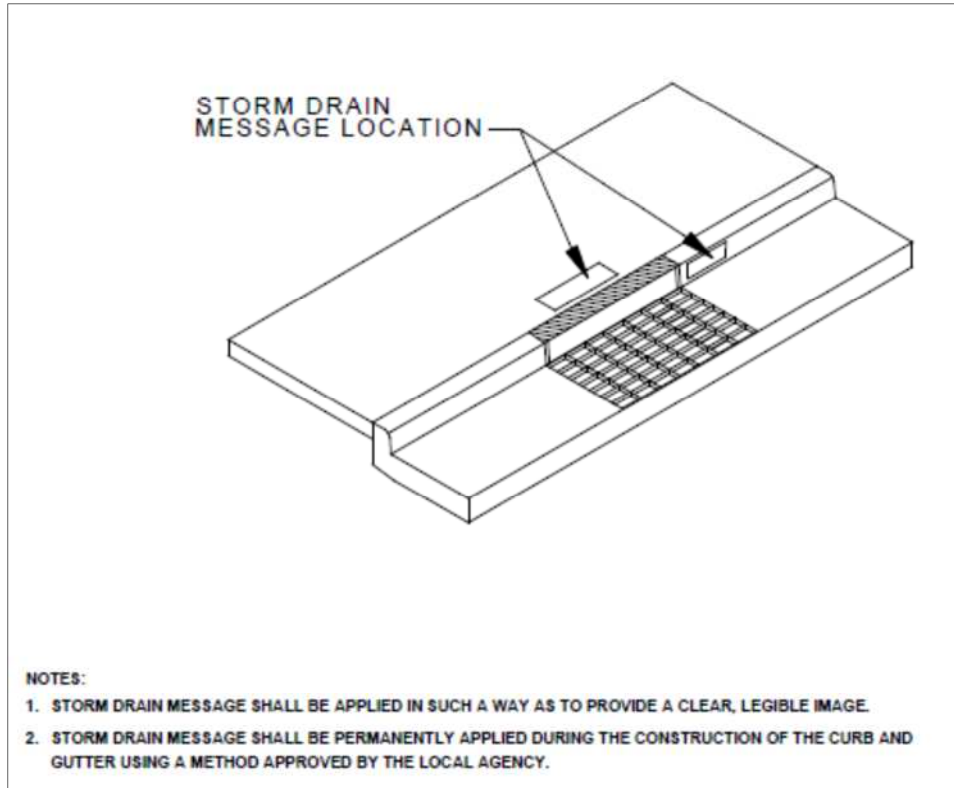

Figure D-1. Storm Drain Message Location – Curb Type Inlet

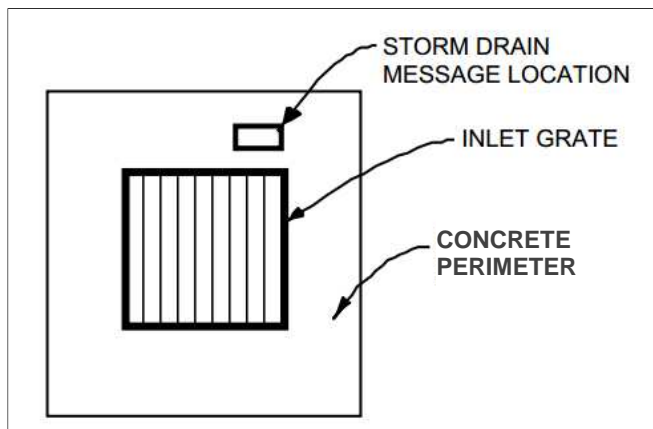

Figure D-2. Storm Drain Message Location – Catch Basin/Area Type Inlet

S-2: Outdoor Material Storage Area

Purpose

The County defines outdoor material storage areas as areas or facilities whose sole purpose is the storage of materials. Materials, including raw materials, by-products, finished products, and waste products, stored outdoors can become sources of pollutants in stormwater runoff if not handled or stored properly. The type of pollutants associated with the materials will vary depending on the type of commercial or industrial activity present.

Materials may be stored in a variety of ways, including bulk piles, containers, shelving, stacking, and tanks. Contamination of stormwater runoff may be prevented by eliminating the possibility of stormwater runoff contact with the material storage areas either through diversion, cover, or capture of the stormwater runoff. Design considerations may also include minimizing the storage area. The source control measures presented in this fact sheet must meet local permitting requirements.

Some materials, such as those containing heavy metals or toxic compounds, are of more concern than other materials. Toxic and hazardous materials must be prevented from coming in contact with stormwater runoff. Non-toxic or non-hazardous materials, such as debris and sediment, can also have significant impacts on receiving waters. Contact between non-toxic or non-hazardous materials and stormwater runoff should be limited, and such materials prevented from being discharged with stormwater runoff.

Materials are classified into three categories based on the potential risk of pollutant release associated with stormwater runoff contact – high risk, medium risk, and low risk. General types of materials under each category are presented in Table D-1. The categorization of the potential pollutant risk is used to determine the design specifications, which are presented in Table D-2, for design features at the project site.

S-2: Outdoor Material Storage Area

Table D-1. Classification of Materials for Potential Pollutant Risk

High Risk Materials	Medium Risk Materials	Low Risk Materials
<ul style="list-style-type: none"> • Recycled materials with discharge potential • Corrosives • Food items • Chalk/gypsum products • Scrap or salvage goods • Feedstock/grain • Fertilizers • Pesticides • Compost • Asphalt • Lime/lye/soda ash • Animal/human wastes • Rubber and plastic pellets or other small pieces • Uncured concrete/cement • Lead and copper, and any metals with oil/grease coating 	<ul style="list-style-type: none"> • Clean recycled materials without discharge potential • Metal (excluding lead and copper, and any metals with oil/grease coating) • Sawdust/bark chips • Sand/soil • Unwashed gravel/rock 	<ul style="list-style-type: none"> • Washed gravel/rock • Finished lumber (non-pressure treated) • Rubber or plastic products (excluding small pieces) • Clean, precast concrete products • Glass products (new) • Inert products • Gaseous products • Products in containers that prevent contact with stormwater (fertilizers and pesticides excluded)

Design Specifications

Design specifications for material storage areas are regulated by local building and fire codes, ordinances, and zoning requirements. Source control measures presented in this fact sheet are intended to enhance and be consistent with local code and ordinance requirements while addressing stormwater runoff concerns. The design specifications, presented in Table D-2, must be incorporated into the design of outdoor material storage areas when stored materials could contribute pollutants to the storm drain system. The level of controls required varies relative to the risk category of the material stored.

As general guidance, downspouts and roofs should be directed away from outdoor materials storage areas, and such storage areas should slope towards a dead-end sump to collect stormwater runoff, non-stormwater runoff, and spills. Stormwater runoff, non-stormwater runoff, and spills must be disposed of in accordance with local, state, and federal laws. Locations of design features, including the features presented in Table D-2, must be included on site maps or plans. Additionally, site maps or plans must show all storage areas for chemicals and/or waste materials, with a tank/drum schedule indicating tank capacities, materials of construction, and contents.

S-2: Outdoor Material Storage Area

Table D-2. Design Specifications for Outdoor Material Storage Areas

Design Feature	Design Specifications
Surfacing	<ul style="list-style-type: none"> • High-Risk Materials: <ul style="list-style-type: none"> ○ Construct/pave outdoor material storage areas with Portland cement concrete or an equivalent impervious surface. Ensure that the surfacing material is chemically-resistant to the materials being stored. • Medium-Risk Materials: <ul style="list-style-type: none"> ○ Construct/pave outdoor material storage areas with Portland cement concrete. • Low-Risk Materials: <ul style="list-style-type: none"> ○ There are no requirements for surfacing.
Enclosures and Covers	<ul style="list-style-type: none"> • High-Risk Materials: <ul style="list-style-type: none"> ○ Place materials in an enclosure such as a shed, cabinet, or other structure that prevents contact with stormwater runoff; or ○ Cover entire storage area with a permanent canopy, roof, or awning to prevent precipitation from making direct contact with and collecting within the storage area. Direct stormwater runoff from the cover away from the storage area to a stormwater runoff disposal point that meets all applicable code, ordinance, and LID Standards Manual requirements. For cover structures that do not include sidewalls, include a roof overhang that extends beyond the grade break. <ul style="list-style-type: none"> ○ Covers 10 feet high or less should extend a minimum of 3 feet beyond the perimeter of the hydraulically-isolated storage area. ○ Covers higher than 10 feet should extend a minimum of either 20 percent of the cover's height or 5 feet beyond the perimeter of the hydraulically-isolated storage area, whichever is greater. ○ LACDPW may grant waivers for covers on a case-by-case basis. • Medium-Risk Materials: <ul style="list-style-type: none"> ○ At a minimum, completely cover material with temporary plastic sheeting during storm events. • Low-Risk Materials: <ul style="list-style-type: none"> ○ There are no requirements for enclosures or covers.

S-2: Outdoor Material Storage Area

Table D-2. Design Specifications for Outdoor Material Storage Areas (continued)

Hydraulic Isolation and Drainage	<ul style="list-style-type: none">• High-Risk Materials:<ul style="list-style-type: none">○ Hydraulically-isolate storage area with grading, berms, drains, dikes, or curbs to prevent stormwater run-on from surrounding areas or roof drains.○ Direct stormwater runoff from surrounding areas away from the hydraulically-isolated storage area to a stormwater runoff disposal point that meets all applicable LID Standards Manual requirements.○ Drainage facilities are not required for the hydraulically-isolated storage area. However, if drainage facilities are provided, drainage from the hydraulically-isolated storage area must be directed to a stormwater runoff disposal point as determined by LACDPW.• Medium-Risk Materials:<ul style="list-style-type: none">○ Drainage from storage area may be allowed, on a case-by-case basis with approval from LACDPW, to a treatment control measure or standard storm drain(s).○ For erodible material, provide grading and a structural containment barrier on at least three sides of each stockpile to prevent stormwater run-on from surrounding areas and migration of material due to wind erosion.• Low-Risk Materials:<ul style="list-style-type: none">○ Provide appropriate drainage from the storage area to minimize contact with materials.
Spill Containment	<ul style="list-style-type: none">• All Materials:<ul style="list-style-type: none">○ Implement spill containment measures where materials are stored in tanks, drums, or similar containers and that may potentially enter the storm drain system, sanitary sewer system, or contaminate the soil. Spill containment must be designed for the volume of the largest tank/drum or 10 percent of the tank/drum total (whichever is greater).○ Separate spill containment systems for all tanks containing incompatible materials such as acids, bases, reactive or flammable materials.○ Clean, repair, and seal (using epoxy or equivalent sealant compatible with the stored materials) the interior wall and floors within all spill containment areas. Identify the areas to be sealed on the site maps.○ Bond the contact joint for spill containment walls or dikes constructed on existing concrete, masonry or asphalt to the existing surface. Identify the areas to be bonded on the site maps.○ Cover the spill containment areas with a roof or awning to minimize collection of stormwater runoff within.○ Store materials collected in spill containment areas until its quality and an appropriate approved disposal method have been determined.

Accumulated Water

Stormwater runoff, non-stormwater runoff, and spills will accumulate in containment areas and sumps with impervious surfaces. Contaminated accumulated water must be disposed of in accordance with applicable laws and regulations, and cannot be discharged directly to the storm drain or sanitary sewer system without appropriate

S-2: Outdoor Material Storage Area

permitting. Contact LACDPW (1-888-CLEAN-LA) for information regarding discharge of contaminated accumulated water.

Maintenance Requirements

The integrity of structural elements that are subject to damage (e.g., screens, covers, signs) must be maintained by the owner/operator as required by local codes and ordinances. Outdoor material storage areas must be checked periodically to ensure containment of accumulated water and prevention of stormwater run-on. Any enclosures and secondary/spill containment areas should be checked periodically to ensure spills are contained efficiently. Maintenance agreements between LACDPW and the owner/operator may be required. Failure to properly maintain building and property may subject the property owner to citation.

S-3: Outdoor Trash Storage and Waste Handling Area

Purpose

Stormwater runoff from areas where trash is stored or handled can be polluted. Loose trash and debris can be easily transported by water or wind into nearby storm drain inlets, channels, and/or receiving waters. Waste handling operations (i.e., dumpsters, litter control, waste piles) may be sources of stormwater pollution.

Design Specifications

Wastes from commercial and industrial sites are typically hauled away for disposal by either public or commercial carriers that may have design or access requirements for waste storage areas. Design specifications for waste handling areas are regulated by local building and fire codes and by current County ordinances and zoning requirements. The design specifications, listed below in Table D-3, are recommendations and are not intended to conflict with requirements established by the waste hauler. The design specifications are intended to enhance local codes and ordinances while addressing stormwater runoff concerns. The waste hauler should be contacted prior to the design of trash storage and collection areas to determine established and accepted guidelines for designing trash collection areas. All hazardous waste must be handled in accordance with the legal requirements established in Title 22 of the California Code of Regulations. Conflicts or issues should be discussed with LACDPW staff.

Table D-3. Design Specifications for Outdoor Trash Storage and Waste Handling Area

Design Feature	Design Specifications
Surfacing	<ul style="list-style-type: none"> • Construct/pave outdoor trash storage and waste handling area with Portland cement concrete or an equivalent impervious surface.
Screens/Covers	<ul style="list-style-type: none"> • Install a screen or wall around trash storage area to prevent off-site transport of loose trash. • Use lined bins or dumpsters to reduce leaking of liquid wastes. • Use waterproof lids on bins/dumpsters or provide a roof to cover storage area enclosure (LACDPW discretion) to prevent precipitation from entering containers.
Grading/Drainage	<ul style="list-style-type: none"> • Berm and/or grade waste handling area to prevent stormwater run-on. • Locate waste handling area at least 35 feet from storm drains. • Divert drainage from adjoining roofs and pavement away from adjacent trash storage areas.
Signs	<ul style="list-style-type: none"> • Post signs on all dumpsters and/or inside enclosures prohibiting disposal of liquids and hazardous materials in accordance with any waste disposal ordinance.

S-3: Outdoor Trash Storage and Waste Handling Area

Accumulated Water

Stormwater runoff, non-stormwater runoff, and spills will accumulate in containment areas and sumps with impervious surfaces. Contaminated accumulated water must be disposed of in accordance with applicable laws and regulations, and cannot be discharged directly to the storm drain or sanitary sewer system without appropriate permitting. Contact LACDPW (1-888-CLEAN-LA) for information regarding discharge of contaminated accumulated water.

Maintenance Requirements

The integrity of structural elements that are subject to damage (e.g., screens, covers, signs) must be maintained by the owner/operator as required by local codes and ordinances. Outdoor trash storage and waste handling areas must be checked periodically to ensure containment of accumulated water and prevention of stormwater run-on. Maintenance agreements between LACDPW and the owner/operator may be required. Failure to properly maintain building and property may subject the property owner to citation.

S-4: Outdoor Loading/Unloading Dock Area

Purpose

Materials spilled, leaked, or lost during loading or unloading may collect on impervious surfaces or in the soil and be carried away by stormwater runoff or when the area is cleaned. Precipitation may also wash pollutants from machinery used to load or unload materials. In particular, loading docks have the potential to contribute heavy metals, nutrients, suspended solids, oils, and grease to stormwater runoff due to the heavy truck traffic and loading and unloading activities. Depressed loading docks (e.g., truck wells) are contained areas that can also accumulate water.

Design Specifications

Design specifications for outdoor loading/unloading dock areas are regulated by local building and fire codes and by current County ordinances and zoning requirements. Additionally, individual businesses may have their own design or access requirements for loading docks. Design specifications presented in this fact sheet are intended to enhance and be consistent with these code and ordinance requirements while addressing stormwater runoff concerns. The design specifications presented in Table D-4 are not intended to conflict with requirements established by individual businesses, but should be followed to the maximum extent practicable.

Accumulated Water

Stormwater runoff, non-stormwater runoff, and spills will accumulate in containment areas and sumps with impervious surfaces, such as depressed loading docks. Contaminated accumulated water must be disposed of in accordance with applicable laws and cannot be discharged directly to the storm drain or sanitary sewer system without appropriate permitting. Contact LACDPW (1-888-CLEAN-LA) for information regarding discharge of contaminated accumulated water.

Maintenance Requirements

The integrity of structural elements that are subject to damage (e.g., covers, signs) must be maintained by the owner/operator as required by local codes and ordinances. If a water quality inlet or infiltration system is installed, it must be maintained as indicated by the manufacturer or installer. Outdoor loading/unloading dock areas must be checked periodically to ensure containment of accumulated water and prevention of stormwater run-on. Maintenance agreements between LACDPW and the owner/operator may be required. Failure to properly maintain building and property may subject the property owner to citation.

S-4: Outdoor Loading/Unloading Dock Area

Table D-4. Design Specifications for Outdoor Loading/Unloading Dock Area

Design Feature	Design Specifications
Surfacing	<ul style="list-style-type: none"> Construct/pave outdoor loading/unloading dock areas with Portland cement concrete or an equivalent impervious surface. Ensure that the surfacing material is chemically-resistant to materials being handled in the loading/unloading dock area.
Covers	<ul style="list-style-type: none"> Cover outdoor loading/unloading dock areas to a distance of at least 10 feet beyond the loading dock or building face if there is no raised dock. If the cover or roof structure does not include sidewalls, then the roof overhang must extend beyond the grade break. The overhang must extend a minimum of 20 percent of the roof height. For interior transfer bays, provide a minimum 10-foot “No Obstruction Zone” to allow trucks or trailers to extend at least 5 feet inside the building. Identify “No Obstruction Zone” clearly on site plans and paint zone with high visibility floor paint. If covers or interior transfer bays are not feasible, install a seal or door skirt and provide a cover to shield all material transfers between trailers and building. LACDPW may grant waivers for covers on a case-by-case basis.
Hydraulic Isolation/Drainage	<ul style="list-style-type: none"> For outdoor loading/unloading dock areas, hydraulically-isolate the first six feet of paved area measured from the building or dock face with grading, berms, or drains to prevent stormwater run-on from surrounding areas or roof drains. Direct stormwater runoff (e.g., from downspouts/roofs) and drainage from surrounding areas away from hydraulically-isolated areas to a stormwater runoff discharge point that meets all applicable LID Standards Manual requirements. For interior transfer bays or bay doors, prevent stormwater runoff from surrounding areas from entering the building with grading or drains. Do not install interior floor drains in the “No Obstruction Zone”. Hydraulically-isolate the “No Obstruction Zone” from any interior floor drains. Do not install direct connections to storm drains from depressed loading docks. Connect drains or direct drainage from hydraulically-isolated loading/unloading dock area to an approved sediment/oil/water separator system connected a discharge location as determined by LACDPW. Provide a manual emergency spill diversion valve upstream of separator system to direct flow, in the event of a spill, to an approved spill containment vault sized to contain a volume equal to 125% of largest container handled at the facility. Provide additional emergency means, such as drain plugs or drain covers, to prevent spills or contaminated stormwater runoff from entering the storm drain system.

S-5: Outdoor Vehicle/Equipment Repair/Maintenance Area

Purpose

Activities in vehicle and equipment repair/maintenance areas that can contaminate stormwater runoff include engine repair, service, and parking (i.e., leaking engines or parts). Pollutants of concern from these facilities include oil and grease, solvents, car battery acid, coolant, and gasoline as well as heavy metals and suspended solids.

Design Specifications

Design specifications for vehicle and equipment repair/maintenance areas are regulated by local building and fire codes and by current County ordinances and zoning requirements. The design specifications presented in this fact sheet are intended to enhance and be consistent with these code and ordinance requirements while addressing stormwater runoff concerns. The design specifications required for vehicle and equipment repair/maintenance areas are presented in Table D-5. All wash water and hazardous and toxic wastes must be prevented from entering the storm drain system.

Table D-5. Design Specifications for Outdoor Vehicle and Equipment Repair/Maintenance Areas

Design Feature	Design Specifications
Surfacing	<ul style="list-style-type: none"> Construct/pave vehicle and equipment repair/maintenance area with Portland cement concrete or an equivalent impervious surface. Where possible, conduct vehicle repair and maintenance activities indoors.
Screens/Covers	<ul style="list-style-type: none"> Cover areas where parts and fluids are stored. Cover or enclose all repair/maintenance areas.
Grading/Drainage	<ul style="list-style-type: none"> Berm or grade vehicle and equipment repair/maintenance areas to prevent stormwater run-on and runoff and contain spills. Direct stormwater runoff from downspouts/roofs and pavement away from vehicle and equipment repair/maintenance areas. Grade the vehicle and equipment repair/maintenance area to drain to a dead-end sump for collection of all wash water, leaks, and spills. Connect drains to a sump for collection and disposal at a discharge location approved by LACDPW. Direct connection of repair/maintenance area to storm drain system is prohibited. If required by LACDPW, obtain an Industrial Waste Disposal Permit. Do not locate storm drains in the immediate vicinity of vehicle and equipment repair/maintenance area.
Emergency Storm Drain Seal	<ul style="list-style-type: none"> Provide means, such as isolation valves, drain plugs, or drain covers, to prevent spills or accumulated water from entering the storm drain system.

S-5: Outdoor Vehicle/Equipment Repair/Maintenance Area

Accumulated Water

Stormwater runoff, non-stormwater runoff, and spills will accumulate in containment areas and sumps with impervious surfaces. Contaminated accumulated water must be disposed of in accordance with applicable laws and cannot be discharged directly to the storm drain or sanitary sewer system without appropriate permitting. Contact LACDPW (1-888-CLEAN-LA) for information regarding discharge of contaminated accumulated water.

Maintenance Requirements

The integrity of structural elements that are subject to damage (e.g., screens, covers, signs) must be maintained by the owner/operator as required by local codes and ordinances. Vehicle and equipment repair/maintenance areas must be checked periodically to ensure containment of accumulated water and prevention of stormwater run-on. Maintenance agreements between LACDPW and the owner/operator may be required. Failure to properly maintain building and property may subject the property owner to citation.

S-6: Outdoor Vehicle/Equipment/Accessory Washing Area

Purpose

Washing vehicles, equipment, and accessories in areas where wash water flows onto the ground can pollute stormwater runoff and adversely impact receiving waters. Pollutants of concern in wash water include oil and grease, heavy metals, solvents, phosphates, and suspended solids. By containing, collecting, diverting, and properly disposing of wash water from outdoor vehicle, equipment, and accessory washing areas to the sanitary sewer system, transport of these potential pollutants is limited.

Design Specifications

Design specifications for vehicle/equipment/accessory washing areas are regulated by local building and fire codes and current County ordinances and zoning requirements. The design specifications presented in Table D-6 are intended to enhance and be consistent with these requirements while addressing stormwater runoff concerns. All wash water and hazardous and toxic wastes must be prevented from entering the storm drain system.

Accumulated Water

Stormwater runoff, non-stormwater runoff, and spills will accumulate in containment areas and sumps with impervious surfaces. Contaminated accumulated water must be disposed of in accordance with applicable laws and cannot be discharged directly to the storm drain or sanitary sewer system without appropriate permitting. Contact LACDPW (1-888-CLEAN-LA) for information regarding discharge of contaminated accumulated water.

Maintenance Requirements

The integrity of structural elements that are subject to damage (e.g., screens, covers, signs) must be maintained by the owner/operator as required by local codes and ordinances. Outdoor vehicle/equipment/accessory washing areas must be checked periodically to ensure containment of accumulated water and prevention of stormwater run-on. Maintenance agreements between LACDPW and the owner/operator may be required. Failure to properly maintain building and property may subject the property owner to citation.

S-6: Outdoor Vehicle/Equipment/Accessory Washing Area

Table D-6. Design Specifications for Outdoor Vehicle/Equipment/Accessory Washing Areas

Design Feature	Design Specifications
Surfacing	<ul style="list-style-type: none"> • Construct/pave vehicle/equipment/accessory washing areas with Portland cement concrete or an equivalent impervious surface.
Covers	<ul style="list-style-type: none"> • Provide a cover that extends over the entire washing area. For covers that do not include sidewalls, include an overhang that extends beyond the grade break. <ul style="list-style-type: none"> ○ Covers 10 feet high or less should extend a minimum of 3feet beyond the perimeter of the hydraulically-isolated area. ○ Covers higher than 10 feet should extend a minimum of either 20 percent of the cover's height or 5 feet beyond the hydraulically-isolated area, whichever is greater. ○ If a cover is not feasible, provide an approved stormwater runoff diversion system along with a clarifier and sample box (County Standard Plan 2043-0). Diverted stormwater runoff may require pretreatment and verification of pollutant concentrations. ○ LACDPW may grant waivers for covers on a case-by-case basis.
Grading/Drainage	<ul style="list-style-type: none"> • Hydraulically-isolate vehicle/equipment/accessory washing area using berms or grading to prevent stormwater run-on and runoff and contain spills. • Grade or berm washing area to contain wash water within the covered area. • Direct wash water to treatment and recycle or pretreatment (e.g., clarifier) and proper connection to the sanitary sewer system. Obtain approval from the governing agency (e.g., Industrial Waste Management Division) before discharging to the sanitary sewer system. • Direct stormwater runoff from downspouts/roofs and pavement away from washing areas. • Do not locate storm drains in the immediate vicinity of washing area.
Emergency Storm Drain Seal	<ul style="list-style-type: none"> • Provide means, such as isolation valves, drain plugs, or drain covers, to prevent spills or accumulated water from entering the storm drain system.

S-7: Fuel and Maintenance Area

Purpose

Spills at vehicle and equipment fueling areas can be a significant source of pollution because fuels contain toxic materials and heavy metals that are not easily removed by stormwater quality control measures. When stormwater runoff mixes with fuel spilled or leaked onto the ground, it becomes contaminated with petroleum-based materials that are harmful to humans, fish, and wildlife. Contamination can occur at large industrial sites or at small commercial sites such as retail gas outlets and convenience stores. Materials such as oil and grease, car battery acid, and coolant also have the potential to contribute to stormwater pollution due to spills at fueling and maintenance areas.

Design Specifications

Design specifications for fuel and maintenance areas are regulated by local building and fire codes and current County ordinances and zoning requirements. The design specifications presented in Table D-7 are intended to enhance and be consistent with these code and ordinance requirements while addressing stormwater runoff concerns.

Accumulated Water

Stormwater runoff, non-stormwater runoff, and spills will accumulate in containment areas and sumps with impervious surfaces. Contaminated accumulated water must be disposed of in accordance with applicable laws and cannot be discharged directly to the storm drain or sanitary sewer system without appropriate permitting. Contact LACDPW (1-888-CLEAN-LA) for information regarding discharge of contaminated accumulated water.

Maintenance Requirements

The integrity of structural elements that are subject to damage (e.g., screens, covers, signs) must be maintained by the owner/operator as required by local codes and ordinances. Fuel and maintenance areas must be checked periodically to ensure containment of accumulated water and prevention of stormwater run-on. Maintenance agreements between LACDPW and the owner/operator may be required. Failure to properly maintain building and property may subject the property owner to citation.

S-7: Fuel and Maintenance Area

Table D-7. Design Specifications for Fuel and Maintenance Areas

Design Feature	Design Criteria
Surfacing	<ul style="list-style-type: none"> • Construct/pave fuel dispensing/maintenance area with Portland cement concrete, or an equivalent smooth impervious surface. Do not use asphalt concrete to construct/pave the fuel dispensing/maintenance area. The fuel dispensing/maintenance area is defined as extending 6.5 feet from the corner of each fuel dispenser or the length at which the hose and nozzle assembly may be operated plus 1 foot, whichever is greater. • Paving around the fuel dispensing/maintenance area may exceed the minimum dimensions of the “fuel dispensing/maintenance area” stated above. • Use asphalt sealant to protect asphalt-paved areas surrounding the fuel dispensing/maintenance area.
Covers	<ul style="list-style-type: none"> • Cover the entire fuel dispensing/maintenance area with a permanent canopy, roof, or awning to prevent precipitation from directly contacting the fuel dispensing/maintenance area. Direct stormwater runoff from the cover and downspouts away from the area to a stormwater runoff disposal point that meets all applicable code, ordinance, and LID Standards Manual requirements. <ul style="list-style-type: none"> ○ Covers 10 feet high or less should extend a minimum of 3 feet beyond the perimeter of the hydraulically-isolated fuel dispensing/maintenance area. ○ Covers higher than 10 feet should extend a minimum of 5 feet beyond the hydraulically-isolated fuel dispensing/maintenance area. • For facilities designed to accommodate very large vehicles or equipment that would prohibit the use of covers, hydraulically-isolate the uncovered fuel dispensing/maintenance area and direct stormwater runoff from the area through upstream control measures to the sanitary sewer system (see Hydraulic Isolation/Drainage section below).
Hydraulic Isolation/Drainage	<ul style="list-style-type: none"> • Design fuel dispensing/maintenance area pad with a 2-4 percent slope to prevent ponding, and include a grade break that separates the area from the rest of the site and prevents stormwater run-on to the maximum extent practicable. Grade the fuel dispensing/maintenance area to an approved location. • Hydraulically-isolate the fuel dispensing/maintenance area to prevent stormwater run-on from surrounding areas or roof drains by one or more of the following methods: <ul style="list-style-type: none"> ○ Perimeter trench drains: Locate trench drains around the fuel dispensing/maintenance area pad perimeter. Direct stormwater runoff from the perimeter drains to one of the following: <ul style="list-style-type: none"> ▪ Sanitary sewer system, upon proper approval. Provide an automatic shut-off valve installed upstream of the sanitary sewer system connection and below grade in a manhole or similar concrete containment structure. The valve must be designed to close automatically when the maximum oil/fuel storage capacity of the structure is reached. ▪ An approved below-grade containment vault with at least 60 ft³ of storage capacity. The vault must be emptied, as required, and contents disposed of in accordance with applicable laws.

S-7: Fuel and Maintenance Area

Table D-7. Design Specifications for Fuel and Maintenance Areas (continued)

Design Feature	Design Criteria
Hydraulic Isolation/Drainage (continued)	<ul style="list-style-type: none"> ○ Fueling pad: Elevate the entire fuel dispensing/maintenance area pad and provide a perimeter drain to isolate the pad. The pad should be graded level such that any spills will stay on the pad for dry clean-up. • Direct stormwater runoff from surrounding areas away from hydraulically-isolated areas to a stormwater runoff discharge point that meets all applicable LID Standards Manual requirements. Locate storm drains for surrounding areas at least 10 feet from the hydraulically-isolated fuel dispensing/maintenance area.
Emergency Storm Drain Seal	<ul style="list-style-type: none"> • Provide means, such as isolation valves, drain plugs, or drain covers, to prevent spills or accumulated from entering the storm drain system. Propose a spill collection and cleanup maintenance plan for the fueling area. When possible and appropriate, encourage use of proper clean-up methods, which are dry clean-up methods, such as sweeping for removal of litter and debris and use of absorbents for liquid spills and leaks.

S-8: Landscape Irrigation Practices

Purpose

Irrigation runoff provides a pathway for pollutants (i.e., nutrients, bacteria, organics, sediment) to enter the storm drain system. By effectively irrigating, less runoff is produced resulting in less potential for pollutants to enter the storm drain system.

General Guidance

- Do not allow irrigation runoff from the landscaped area to drain directly to storm drain system.
- Minimize use of fertilizer, pesticides, and herbicides on landscaped areas.
- Plan sites with sufficient landscaped area and dispersal capacity (e.g., ability to receive irrigation water without generating runoff).
- Consult a landscape professional regarding appropriate plants, fertilizer, mulching applications, and irrigation requirements (if any) to ensure healthy vegetation growth.

Design Specifications

- Choose plants that minimize the need for fertilizer and pesticides.
- Group plants with similar water requirements and water accordingly.
- Use mulch to minimize evaporation and erosion.
- Include a vegetative boundary around project site to act as a filter.
- Design the irrigation system to only water areas that need it.
- Install an approved subsurface drip, pop-up, or other irrigation system.¹ The irrigation system should employ effective energy dissipation and uniform flow spreading methods to prevent erosion and facilitate efficient dispersion.
- Install rain sensors to shut off the irrigation system during and after storm events.
- Include pressure sensors to shut off flow-through system in case of sudden pressure drop. A sudden pressure drop may indicate a broken irrigation head or water line.
- If the hydraulic conductivity in the soil is not sufficient for the necessary water application rate, implement soil amendments to avoid potential geotechnical hazards (i.e., liquefaction, landslide, collapsible soils, and expansive soils).

¹ If alternative distribution systems (e.g., spray irrigation) are approved, the County will establish guidelines to implement these new systems.

S-8: Landscape Irrigation Practices

- For sites located on or within 50 feet of a steep slope (15% or greater), do not irrigate landscape within three days of a storm event to avoid potential geotechnical instability.²
- Implement Integrated Pest Management practices.

For additional guidelines and requirements, refer to the Los Angeles County Department of Health Services.

Maintenance Requirements

Maintain irrigation areas to remove trash and debris and loose vegetation. Rehabilitate areas of bare soil. If a rain or pressure sensor is installed, it should be checked periodically to ensure proper function. Inspect and maintain irrigation equipment and components to ensure proper functionality. Clean equipment as necessary to prevent algae growth and vector breeding. Maintenance agreements between LACDPW and the owner/operator may be required. Failure to properly maintain building and property may subject the property owner to citation.

² As determined by the City of Los Angeles, Building and Safety Division

S-9: Building Materials Selection

Purpose

Building materials can potentially contribute pollutants of concern to stormwater runoff through leaching. For example, metal buildings, roofing, and fencing materials may be significant sources of metals in stormwater runoff, especially due to acidic precipitation. The use of alternative building materials can reduce pollutant sources in stormwater runoff by eliminating compounds that can leach into stormwater runoff. Alternative building materials may also reduce the need to perform maintenance activities (i.e., painting) that involve pollutants of concern, and may reduce the volume of stormwater runoff. Alternative materials are available to replace lumber and paving.

Design Specifications

Lumber

Decks and other house components constructed using pressure-treated wood that is typically treated using arsenate, copper, and chromium compounds are hazardous to the environment. Pressure-treated wood may be replaced with cement-fiber or vinyl.

Roofs, Fencing, and Metals

Minimizing the use of copper and galvanized (zinc-coated) metals on buildings and fencing can reduce leaching of these pollutants into stormwater runoff. The following building materials are conventionally made of galvanized metals:

- Metal roofs;
- Chain-link fencing and siding; and
- Metal downspouts, vents, flashing, and trim on roofs.

Architectural use of copper for roofs and gutters should be avoided. As an alternative to copper and galvanized materials, coated metal products are available for both roofing and gutter application. Vinyl-coated fencing is an alternative to traditional galvanized chain-link fences. These products eliminate contact of bare metal with precipitation or stormwater runoff, and reduce the potential for stormwater runoff contamination. Roofing materials are also made of recycled rubber and plastic.

Green roofs may be an option. Green roofs use vegetation such as grasses and other plants as an exterior surface. The plants reduce the velocity of stormwater runoff and absorb water to reduce the volume of stormwater runoff. One potential problem with using green roofs in the Los Angeles County area is the long, hot and dry summers, which may kill the plants if they are not watered. See the Green Roof Fact Sheet (RET-7) in Appendix E.

Pesticides

The use of pesticides around foundations can be reduced through the use of alternative barriers. Sand barriers can be applied around foundations to deter termites, as they cannot tunnel through sand. Metal shields also block termites from tunneling. Additionally, diatomaceous earth can be used to repel or kill a wide variety of other pests.

Maintenance Requirements

The integrity of structural elements that are subject to damage (e.g., signs) must be maintained by the owner/operator as required by local codes and ordinances. Maintenance agreements between LACDPW and the owner/operator may be required. Failure to properly maintain building and property may subject the property owner to citation.

S-10: Animal Care and Handling Facilities

Purpose

Animal care, confinement, and slaughter may potentially contribute nutrients, bacteria and viruses, and other pollutants to stormwater runoff. Implementing source control measures, such as preventing stormwater runoff in animal care and confinement areas and good housekeeping, reduces the potential for pollutant mobilization from animal care and handling facilities into stormwater runoff.

It should be noted that this fact sheet does not address concentrated animal feeding operations, as defined by the USEPA.

Design Specifications

General Specifications

- Site barns, corrals, and pastures on property that drains away from the storm drain system and receiving waters.
- Locate animal washing areas, pastures, horse riding areas, stalls, or cages at least 50 feet away from storm drains, domestic wells, septic tank or leach field sites, and receiving waters.
- Design berms, gutters, or grassed ditches to divert stormwater runoff away from animal area, storm drain system, and receiving waters.
- Cover animal enclosures (i.e., stables) to protect them from precipitation.
- Prevent animals from entering sensitive environmental areas.
- Regularly sweep or shovel animal holding areas.

Grazing Management

- Focus on protecting the pasture's soil and vegetative cover. Prevent bare areas from forming.
- Clip tall weeds and old grass to control weeds and stimulate grass growth.
- Establish healthy and vigorous pastures with at least three inches of leafy material present.
- Subdivide grazing areas into three or more units of equal size, which can be grazed in rotation.
- Allow pastures to grow to 8-10 inches before allowing grazing.
- Rotate animals to clean pastures when grass is grazed down to 3-4 inches.
- Manage grazing so that a cover of dry residual vegetation protects soil from the first storm event of the season.
- Keep animals away from wet fields when possible.

S-10: Animal Care and Handling Facilities

- During periods of heavy precipitation, consider indoor feeding.
- Use manure and soiled bedding sparingly to fertilize pastures and croplands.
- Use turnout paddocks as "sacrifice areas" to preserve pastures.

Horse Access to Waterways

- Prevent trampling of streamside vegetation.
- Design stream crossings to minimize erosion.

Horse Waste Management

- Collect manure to prevent it from entering the storm drain system or receiving waters.
- Store collected manure on high ground to reduce contact with stormwater runoff.
- After clean-up during the summer, water the areas where horses frequently deposit manure to promote decomposition.
- Store horse waste in sturdy, insect-resistant, and seepage-free units that have an impervious surface bottom and a cover to prevent leaching and runoff, such as:
 - Plastic garbage cans with lids;
 - Fly-tight wooden or concrete storage sheds;
 - Composters; or
 - Pits or trenches lined with an impermeable layer.
- Remove accumulated manure from the site frequently using the following methods:
 - Composting. Keep compost piles moist and well-aerated to promote decomposition;
 - Give away composted material to local greenhouses, nurseries and botanical gardens;
 - Transport manure to topsoil companies or composting centers; or
 - Fertilize pastures, cropland, and lawns with manure and soiled bedding. Do not apply fertilizer just before or during storm events and apply these materials sparingly.

Maintenance Requirements

The integrity of structural elements that are subject to damage (e.g., enclosures) must be maintained by the owner/operator as required by local codes and ordinances. Manure must be collected from site frequently and covered until properly disposed of. Enclosures must be checked periodically to ensure roof is leak-free. Maintenance agreements between LACDPW and the owner/operator may be required. Failure to properly maintain building and property may subject the property owner to citation.

S-11: Outdoor Horticulture Areas

Purpose

Horticulture areas may potentially contribute nutrients, bacteria, organics, sediment, and other pollutants to the stormwater runoff. Irrigation runoff provides a pathway for pollutants to enter the storm drain system. Implementation of source control measures can reduce the potential for pollutant mobilization from outdoor horticulture areas into stormwater runoff.

General Guidance

- Do not allow wash water from the horticulture area to drain directly to the storm drain system or receiving waters.

Maintenance Requirements

Preventative maintenance includes weeding, pruning back excess plant growth, and removing leaf and other debris. Maintenance agreements between LACDPW and the owner/operator may be required. Failure to properly maintain building and property may subject the property owner to citation.

APPENDIX E

Stormwater Quality Control Measure Fact
Sheets

Appendix E – Stormwater Quality Control Measure Fact Sheets

Table of Contents

RET-1: Bioretention	E-1
RET-2: Infiltration Basin	E-11
RET-3: Infiltration Trench	E-23
RET-4: Dry Well	E-32
RET-5: Permeable Pavement without an Underdrain.....	E-41
RET-6: Rain Barrel/Cistern.....	E-50
BIO-1: Biofiltration	E-53
VEG-1: Green Roof	E-69
VEG-2: Stormwater Planter	E-77
VEG-3: Tree-Well Filter	E-88
VEG-4: Vegetated Swales.....	E-99
VEG-5: Vegetated Filter Strip.....	E-114
T-1: Sand Filter	E-126
T-2: Constructed Wetland	E-138
T-3: Extended Detention Basin	E-153
T-4: Wet Pond	E-169
T-5: Permeable Pavement with an Underdrain	E-186
T-6: Proprietary Treatment Control Measures.....	E-191

RET-1: Bioretention



Description

A bioretention area is a vegetated shallow depression that is designed to receive, retain, and infiltrate stormwater runoff from downspouts, piped inlets, or sheet flow from adjoining paved areas. A shallow ponding zone is provided above the vegetated surface for temporary storage of stormwater runoff. During storm events, stormwater runoff accumulates in the ponding zone and gradually infiltrates and filters through the bioretention soil media

before infiltrating the underlying soil.

Stormwater runoff treatment occurs through a variety of natural mechanisms as stormwater runoff filters through the vegetated root zone. A portion of the water held in the root zone of the soil media is returned to the atmosphere through transpiration by the plants. Bioretention areas are typically planted with native, drought-tolerant plant species (i.e., wildflowers, sedges, rushes, ferns, shrubs, small trees) that do not require fertilization and can withstand wet soils for at least 24 hours.

A schematic of a typical bioretention area is presented in Figure E-1.

LID Ordinance Requirements

Bioretention can be used to meet the on-site retention requirement of the LID Ordinance. Bioretention will prevent pollutants in the SWQDv from being discharged off-site.

Advantages

- Provides shade and windbreaks
- Enhances site aesthetics
- Retains stormwater runoff and eliminates pollutant discharge
- May conserve water

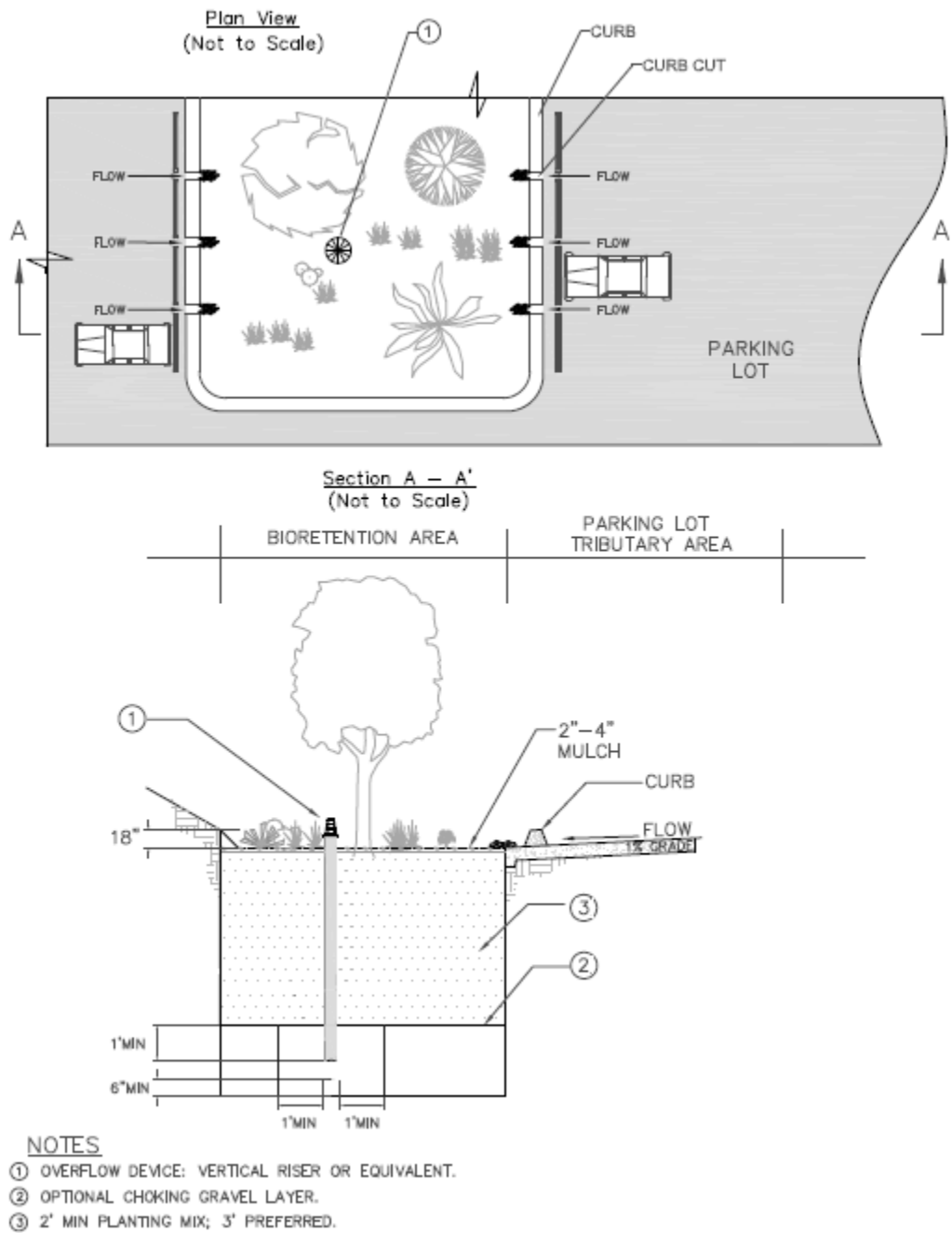

Figure E-1. Bioretention Area Schematic

Disadvantages

- May not be appropriate for industrial sites or locations with contaminated soils or where spills may occur because of the potential threat to groundwater contamination
- Is not suitable for areas with a shallow groundwater table or unstable surface stratum, including steep (greater than 20 percent) or unstable slopes
- May result in standing water, which may allow vector breeding

General Constraints and Implementation Considerations

- Bioretention areas can be applied in various settings, including, but not limited to:
 - Individual lots for rooftop, driveway, and other on-lot impervious surface
 - Shared facilities located in common areas for individual lots
 - Areas within loop roads or cul-de-sacs
 - Landscaped parking lot islands
 - Within right-of-ways along roads
 - Common landscaped areas in apartment complexes or other multi-family housing designs
 - Parks and along open space perimeters
- If tire curbs are provided and parking stalls are shortened, cars may overhang the bioretention area.
- Bioretention areas must be located sufficiently far from structure foundations to avoid damage to structures (as determined by a certified structural or geotechnical engineer).
- Any parking areas bordering the bioretention area must be monolithically poured concrete or deepened curb concrete to provide structural stability to the adjacent parking section.
- The overflow device must drain away from building foundations to the storm drain system or another suitable infiltration area.
- Bioretention areas cannot be located on sites with a slope greater than 20 percent (5:1).
- The project site must be graded to minimize erosion as stormwater runoff enters the bioretention area by creating sheet flow conditions rather than a concentrated stream condition or by providing energy dissipation devices at the inlet.
- The general landscape irrigation system should incorporate the bioretention area, as applicable. Sediment controls (i.e., silt fences) can be used around the bioretention area to prevent high sediment loads from entering the area during construction activities.

- During construction, activities should avoid compaction of native soils below planting media layer or gravel zone.
- Stormwater runoff must be diverted around the bioretention area during the period of vegetation establishment. If diversion is not feasible, the graded and seeded areas must be protected with suitable sediment controls (i.e., silt fences).

Design Specifications

The following sections describe the design specifications for bioretention areas.

Geotechnical

Due to the potential to contaminate groundwater, cause slope instability, impact surrounding structures, and potential for insufficient infiltration capacity, an extensive geotechnical site investigation must be conducted during the site planning process to verify site suitability for bioretention. All geotechnical investigations must be performed according to the most recent Geotechnical and Materials Engineering Division (GMED) Policy GS 200.1. Soil infiltration rates and the groundwater table depth must be evaluated to ensure that conditions are satisfactory for proper operation of a bioretention area. The project applicant must demonstrate through infiltration testing, soil logs, and the written opinion of a licensed civil engineer that sufficiently permeable soils exist on-site to allow the construction of a properly functioning bioretention system.

Bioretention is appropriate for soils with a minimum corrected in-situ infiltration rate of 0.3 in/hr. The geotechnical report must determine if the proposed project site is suitable for a bioretention area and must recommend a design infiltration rate (see “Design Infiltration Rate” under the “Sizing” section). The geotechnical investigation should be such that a good understanding is gained as to how the stormwater runoff will move through the soil (horizontally or vertically) and if there are any geological conditions that could inhibit the movement of water.

Pretreatment

Pretreatment is important for all structural stormwater quality control measures, but it is particularly important for retention facilities. Pretreatment refers to design features that provide settling of large particles before stormwater runoff enters a stormwater quality control measure in order to reduce the long-term maintenance burden. Pretreatment should be provided to reduce the sediment load entering a bioretention area in order to maintain the infiltration rate of the bioretention area. To ensure that bioretention areas are effective, the project applicant must incorporate pretreatment devices that provide sediment reduction (e.g., vegetated swales, vegetated filter strips, sedimentation manholes, and proprietary devices). The use of at least two pretreatment devices is highly recommended for bioretention areas.

Setbacks

Bioretention areas must be sited following the setbacks from the most recent GMED Policy GS 200.1.

Geometry

- Bioretention areas must be sized to capture and retain the SWQDv with an 18-inch maximum ponding depth.
- The planting soil depth must be a minimum of two feet, but three feet is preferred. The planting soil depth should provide a beneficial root zone for the chosen vegetation and adequate storage for the SWQDv.

Sizing

Bioretention areas are sized using a simple sizing method where the SWQDV must be completely infiltrated within 96 hours. Bioretention areas provide stormwater runoff storage above ground.

Step 1: Determine the SWQDV

Bioretention areas must be designed to capture and retain the SWQDV (see Section 6 for SWQDV calculation procedures).

Step 2: Determine the design infiltration rate

Determine the corrected in-situ infiltration rate (f_{design}) of the native soil using the procedures described in the most recent GMED Policy GS 200.1.

Step 3: Calculate the bioretention area

Determine the required size of the bioretention area by assuming the SWQDV will fill the available ponding depth. The maximum depth of stormwater runoff that can be infiltrated within the maximum retention time (96 hrs) is calculated using the following equation:

$$d_{max} = \frac{f_{design}}{12} \times t$$

Where:

d_{max} = Maximum depth of water that can be infiltrated within the required drawdown time [ft];

f_{design} = Design infiltration rate [in/hr]; and

t = Maximum detention time (max 96 hrs) [hr].

Select the ponding depth (d_p) such that:

$$d_{max} \geq d_p$$

Where:

d_{max} = Maximum depth of water that can be infiltrated within the maximum retention time [ft]; and

d_p = Ponding depth (max 1.5 ft) [ft].

Calculate the infiltrating surface area (bottom of the bioretention area) required:

$$A = \frac{SWQDv}{d_p}$$

Where:

A = Surface area of the bottom of the infiltration basin [ft²];

SWQDv = Stormwater quality design volume [ft³]; and

d_p = Ponding depth [ft].

Flow Entrance and Energy Dissipation

Maintain a minimum slope of 1 percent for pervious surfaces and 0.5 percent for impervious surfaces to the bioretention area inlet. The following types of flow entrances can be used for bioretention areas:

- Level spreaders (i.e., slotted curbs) can be used to facilitate sheet flow.
- Dispersed low velocity flow across a landscape area. Dispersed flow may not be possible given space limitations or if the bioretention area is controlling roadway or parking lot flows where curbs are mandatory.
- Dispersed flow across pavement or gravel and past wheel stops for parking areas.
- Flow spreading trench around perimeter of bioretention area. May be filled with pea gravel or vegetated with 3:1 side slopes similar to a swale. A vertical-walled open trench may also be used at the discretion of the Los Angeles County Department of Public Works (LACDPW).
- Curb cuts for roadside or parking lot areas, if approved by LACDPW: curb cuts should include rock or other erosion controls in the channel entrance to dissipate energy. Flow entrance should drop two to three inches from curb line and provide an area for settling and periodic removal of sediment and coarse material before flow disperses to the remainder of the bioretention area.
- Piped entrances, such as roof downspouts, should include rock, splash blocks, or other erosion controls at the entrance to dissipate energy and disperse flows.

- Woody plants (i.e., trees, shrubs) can restrict or concentrate flows and can be damaged by erosion around the root ball and must not be placed directly in the entrance flow path.

Drainage

Bioretention areas must completely drain within 96 hours. Soils must be allowed to dry out periodically in order to restore hydraulic capacity to receive stormwater runoff from subsequent storm events, maintain infiltration rates, maintain adequate soil oxygen levels for healthy soil biota and vegetation, and provide proper soil conditions for biodegradation and retention of pollutants.

Hydraulic Restriction Layer

Lateral infiltration pathways may need to be restricted due to the close proximity of roads, foundations, or other infrastructure. A geomembrane liner, or other equivalent waterproofing, may be placed along the vertical walls to reduce lateral flows. The geomembrane liner must have a minimum thickness of 30 mils and meet the requirements of Table E-1. Generally, waterproof barriers must not be placed at the bottom of the bioretention area as it would prevent incidental infiltration which is important to meeting the required on-site retention requirement.

Table E-1. Geomembrane Liner Specifications for Bioretention Areas

Parameter	Test Method	Specifications
Material		Non-woven geomembrane liner
Unit weight		8 oz/yd ³ (minimum)
Filtration rate		0.08 in/sec (minimum)
Puncture strength	ASTM D-751 (Modified)	125 lbs (minimum)
Mullen burst strength	ASTM D-751	400 lb/in ² (minimum)
Tensile strength	AST D-1682	300 lbs (minimum)
Equiv. opening size	US Standard Sieve	No. 80 (minimum)

Vegetation

Prior to installation, a licensed landscape architect must certify that all plants, unless otherwise specifically permitted, conform to the standards of the current edition of American Standard for Nursery Stock as approved by the American Standards Institute, Inc. All plant grades shall be those established in the current edition of American Standards for Nursery Stock.

- Shade trees must have a single main trunk. Trunks must be free of branches below the following heights:

CALIPER (in)	Height (ft)
1½-2½	5
3	6

- Plants must be tolerant of summer drought, ponding fluctuations, and saturated soil conditions for 96 hours.
- It is recommended that a minimum of three types of tree, shrubs, and/or herbaceous groundcover species be incorporated to protect against facility failure due to disease and insect infestations of a single species.
- Native plant species and/or hardy cultivars that are not invasive and do not require chemical inputs must be used to the maximum extent practicable.

The bioretention area should be vegetated to resemble a terrestrial forest community ecosystem, which is dominated by understory trees, a shrub layer, and herbaceous ground cover. Select vegetation that:

- Will be dense and strong enough to stay upright, even in flowing water;
- Has minimum need for fertilizers;
- Is not prone to pests and is consistent with Integrated Pest Management practices;
- Will withstand being inundated for periods of time; and
- Is consistent with local water conservation ordinance requirements.

Irrigation System

Provide an irrigation system to maintain viability of vegetation, if applicable. The irrigation system must be designed to local code or ordinance specifications.

Restricted Construction Materials

Use of pressure-treated wood or galvanized metal at or around a bioretention area is prohibited.

Overflow Device

An overflow device is required at the 18-inch ponding depth. The following, or equivalent, should be provided:

- A vertical PVC pipe (SDR 26) to act as an overflow riser.
- The overflow riser(s) should be eight inches or greater in diameter, so it can be cleaned without damage to the pipe.
- The inlet to the riser should be at the ponding depth (18 inches for fenced bioretention areas and 6 inches for areas that are not fenced), and be capped

with a spider cap to exclude floating mulch and debris. Spider caps should be screwed in or glued (e.g., not removable). The overflow device should convey stormwater runoff in excess of the SWQDv to an approved discharge location (e.g., another stormwater quality control measure, storm drain system, or receiving water).

Maintenance Requirements

Maintenance and regular inspections are important for proper function of bioretention areas. Bioretention areas require annual plant, soil, and mulch layer maintenance to ensure optimal infiltration, storage, and pollutant removal capabilities. In general, bioretention maintenance requirements are typical landscape care procedures, which include:

- Irrigate plants as needed during prolonged dry periods. In general, plants should be selected to be drought-tolerant and not require irrigation after establishment (two to three years).
- Inspect flow entrances, ponding area, and surface overflow areas periodically, and replace soil, plant material, and/or mulch layer in areas if erosion has occurred. Properly-designed facilities with appropriate flow velocities should not cause erosion except potentially during in extreme events. If erosion occurs, the flow velocities and gradients within the bioretention area and energy dissipation and erosion protection strategies in the pretreatment area and flow entrance should be reassessed. If sediment is deposited in the bioretention area, identify the source of the sediment within the tributary area, stabilize the source, and remove excess surface deposits.
- Prune and remove dead plant material as needed. Replace all dead plants, and if specific plants have a high mortality rate, assess the cause and, if necessary, replace with more appropriate species.
- Remove weeds as needed until plants are established. Weed removal should become less frequent if the appropriate plant species are used and planting density is attained.
- Select the proper soil mix and plants for optimal fertility, plant establishment, and growth to preclude the use of nutrient and pesticide supplements. By design, bioretention facilities are located in areas where phosphorous and nitrogen levels are often elevated such that these should not be limiting nutrients. Addition of nutrients and pesticides may contribute pollutant loads to receiving waters.
- In areas where heavy metals deposition is likely (i.e., tributary areas to industrial, vehicle dealerships/repair, parking lots, roads), replace mulch annually. In areas where metals deposition is less likely (i.e., residential lots), replace or add mulch as needed to maintain a two- to three- inch depth at least once every two years.
- Analyze soil for fertility and pollutant levels if necessary. Bioretention soil media are designed to maintain long-term fertility and pollutant processing capability.
- Eliminate standing water to prevent vector breeding.

- Inspect overflow devices for obstructions or debris, which should be removed immediately. Repair or replace damaged pipes upon discovery.

A summary of potential problems that may need to be addressed by maintenance activities is presented in Table E-2.

The County requires execution of a maintenance agreement to be recorded by the property owner for the on-going maintenance of any privately-maintained stormwater quality control measures. The property owner is responsible for compliance with the maintenance agreement. A sample maintenance agreement is presented in Appendix H.

Table E-2. Bioretention Troubleshooting Summary

Problem	Conditions When Maintenance Is Needed	Maintenance Required
Vegetation	Overgrown vegetation	Mow and prune vegetation as appropriate.
	Presence of invasive, poisonous, nuisance, or noxious vegetation or weeds	Remove this vegetation and plant native species as needed.
Trash and Debris	Trash, plant litter, and dead leaves present	Remove and properly dispose of trash and debris.
Irrigation (if applicable)	Not functioning correctly	Check irrigation system for clogs or broken lines and repair as needed.
Flow Entrance/Overflow Device	Flow entrance/overflow areas clogged with sediment and/or debris	Remove material.
	Overflow device blocked or broken	Clean and/or repair as needed.
Erosion/Sediment Accumulation	Presence of erosion or sediment accumulation	Check flow entrance to ensure proper function. Repair, or replace if necessary, the flow entrance. Repair eroded areas with gravel as needed. Re-grade the bioretention area as needed.
Contaminants and Pollution	Any evidence of oil, gasoline, contaminants, or other pollutants	Remove any evidence of visual contamination from floatables such as oil and grease.
Standing water	Standing water observed more than 96 hours after storm event	Remove and replace plant media (sand, gravel, topsoil, mulch) and vegetation

RET-2: Infiltration Basin



Description

An infiltration basin is a shallow earthen basin constructed in naturally permeable soil designed for retaining and infiltrating stormwater runoff into the underlying native soils and the groundwater table. The bottoms of the basins are typically vegetated with dry-land grasses or irrigated turf grass. Infiltration basins can provide stormwater runoff treatment through a variety of natural mechanisms (i.e., filtration, adsorption, biological degradation) as water flows through

the soil profile.

A schematic of a typical infiltration basin is presented in Figure E-2.

LID Ordinance Requirements

Infiltration basins can be used to meet the on-site retention requirements of the LID Ordinance. Infiltration basins will prevent pollutants in the SWQDv from being discharged off-site.

Advantages

- Retains stormwater runoff and eliminates pollutant discharge
- Reduces peak stormwater runoff flows, which provides erosion control
- Provides groundwater recharge

Disadvantages

- May not be appropriate for areas with too low or too high permeability soils
- May not be appropriate for industrial sites or locations with contaminated soils or where spills may occur because of the potential threat to groundwater contamination
- Must be protected from high sediment loads
- May result in standing water, which may allow vector breeding
- Has a large footprint
- Is not appropriate on fill or sites with steep slopes

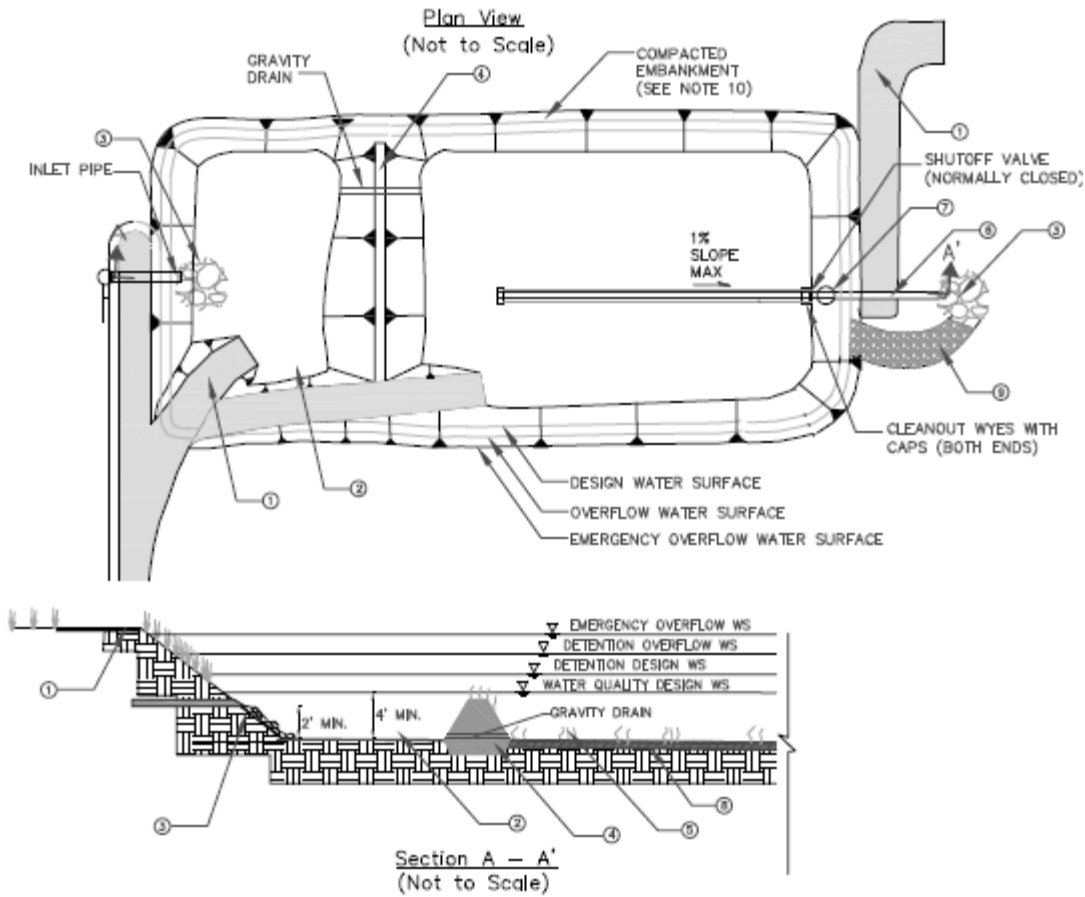

- NOTES:**
- ① MAINTENANCE RAMP SHOULD BE PAVED. SLOPE SHOULD NOT EXCEED 12%. MAINTENANCE RAMP SHOULD PROVIDE ACCESS TO BOTH THE FIRST CELL AND MAIN BASIN.
 - ② UPSTREAM PRETREATMENT SHALL BE PROVIDED. SEDIMENT FOREBAY WITH VOLUME EQUAL TO 25% OF TOTAL INFILTRATION BASIN VOLUME MAY BE USED IN LIEU OF UPSTREAM PRETREATMENT. DEPTH SHALL BE 4' MIN TO 8' MAX PLUS AN ADDITIONAL 1 FOOT MIN SEDIMENT STORAGE DEPTH.
 - ③ RIP RAP APRON OR OTHER ENERGY DISSIPATION.
 - ④ EXTEND EARTHEN BERM ACROSS ENTIRE WIDTH OF THE INFILTRATION BASIN.
 - ⑤ INFILTRATION BASIN BOTTOM AND SIDE SLOPES SHALL BE PLANTED WITH DROUGHT TOLERANT VEGETATION. DEEP ROOTED VEGETATION PREFERRED FOR BASIN BOTTOM. NO TOPSOIL SHALL BE ADDED TO INFILTRATION BASIN BED.
 - ⑥ SIZE OUTLET PIPE TO PASS CAPITAL DESIGN PEAK FLOW FOR ON-LINE INFILTRATION BASINS AND WATER QUALITY PEAK FLOW FOR OFF-LINE INFILTRATION BASINS.
 - ⑦ WATER QUALITY OUTLET STRUCTURE. SEE FIGURE 7-2 AND FIGURE 7-3 FOR DETAILS.
 - ⑧ OVER EXCAVATE BASIN BOTTOM 1 FOOT. RE-PLACE EXCAVATED MATERIAL UNIFORMLY WITHOUT COMPACTION. AMENDING EXCAVATED MATERIAL WITH 2" - 4" OF COARSE SAND IS RECOMMENDED FOR SOILS WITH BORDER LINE INFILTRATION CAPACITY.
 - ⑨ INSTALL EMERGENCY OVERFLOW SPILLWAY AS NEEDED. SEE FIGURE 2-4 FOR DETAILS
 - ⑩ EMBANKMENT SIDE SLOPES SHALL BE NO STEEPER THAN 3H:1V BOTH OUTSIDE AND INSIDE.

Figure E-2. Infiltration Basin Schematic

General Constraints and Implementation Considerations

- Infiltration basins can be applied to a variety of situations, including, but not limited to:
 - Mixed use and commercial development;
 - Roads and parking lots;
 - Parks and open space; and
 - Single- and multi-family residential
- Infiltration basins can be integrated into open space buffers and other landscape areas.
- The potential for groundwater contamination must be carefully considered,. Infiltration basins are not suitable for sites that:
 - Use or store chemicals or hazardous materials, unless they are prevented from entering the basin; or
 - Un-remediated “brownfield sites” where there is known groundwater or soil contamination.
- If the corrected in-situ infiltration rate exceeds 2.4 in/hr, then stormwater runoff may need to be fully-treated with an upstream stormwater quality control measure prior to infiltration to protect groundwater quality.
- Infiltration basins cannot be located on sites with a slope greater than 20 percent (5:1).
- Pretreatment to remove sediment is required to protect infiltration basin from high sediment loads. If upstream pretreatment devices are not provided, a sediment forebay, which takes up at least 25 percent of the basin area, is required.
- If possible, the entire tributary area of the infiltration basin should be stabilized before construction begins. If this is not possible, all flows should be diverted around the infiltration basin to protect it from sediment loads during construction or the top two inches of soil from the infiltration basin floor should be removed after the site has been stabilized. Excavated material should be stored such that it cannot be washed back into the infiltration basin if a storm occurs during construction.
- The equipment used to construct the infiltration basin should have extra wide, low-pressure tires. Construction traffic should not enter the infiltration basin because it can compact soil, which reduces infiltration capacity. If heavy equipment is used on the base of the infiltration basin, the infiltrative capacity may be restored by tilling or aerating prior to placing the infiltrative bed.
- Final grading must produce a level basin bottom without low spots or depressions. After final grading, the infiltration basin bottom should be deep-tilled to improve infiltration.

- After construction is completed, the entire tributary area to the infiltration basin should be stabilized before allowing stormwater runoff to enter it.

Design Specifications

The following sections provide design specifications for infiltration basins.

Geotechnical

Due to the potential to contaminate groundwater, cause slope instability, impact surrounding structures, and potential for insufficient infiltration capacity, an extensive geotechnical site investigation must be conducted during the site planning process to verify site suitability for an infiltration basin. All geotechnical investigations must be performed according to the most recent GMED Policy GS 200.1. Soil infiltration rates and the groundwater table depth must be evaluated to ensure that conditions are satisfactory for proper operation of an infiltration basin. The project applicant must demonstrate through infiltration testing, soil logs, and the written opinion of a licensed civil engineer that sufficiently permeable soils exist on-site to allow the construction of a properly functioning infiltration basin.

Infiltration basins are appropriate for soils with a minimum corrected in-situ infiltration rate of 0.3 in/hr. The geotechnical report must determine if the proposed project site is suitable for an infiltration basin and must recommend a design infiltration rate (see “Design Infiltration Rate” under the “Sizing” section). The geotechnical investigation should be such that a good understanding is gained as to how the stormwater runoff will move through the soil (horizontally or vertically) and if there are any geological conditions that could inhibit the movement of water.

Pretreatment

Pretreatment is important for all structural stormwater quality control measures, but it is particularly important for retention facilities. Pretreatment refers to design features that provide settling of large particles before stormwater runoff enters a stormwater quality control measure in order to reduce the long-term maintenance burden. Pretreatment should be provided to reduce the sediment load entering an infiltration basin in order to maintain the infiltration rate of the infiltration basin. To ensure that infiltration basins are effective, the project applicant must incorporate pretreatment devices that provide sediment reduction (e.g., vegetated swales, vegetated filter strips, sedimentation basins or forebays, sedimentation manholes, and proprietary devices). The use of at least two pretreatment devices is highly recommended for infiltration basins.

Setbacks

Infiltration basins must be sited following the setbacks from the most recent GMED Policy GS 200.1.

Geometry

- Infiltration basins must be designed and constructed with the flattest bottom slope possible to promote uniform ponding and infiltration.
- The side slopes must be no steeper than 3:1 (H:V).
- If upstream pretreatment is not provided to reduce sediment loads or if the tributary catchment area is mostly impervious, a sediment forebay is required. The sediment forebay should be separated from the infiltration basin by a berm or similar feature, and must be equal to 25 percent of the total infiltration basin volume. The sediment forebay must be designed with a minimum length-to-width ratio of 2:1 and must completely drain to the main infiltration basin through an 8-inch (minimum) low-flow outlet. All inlets must enter the sediment forebay. If there are multiple inlets into the sediment forebay, the length-to-width ratio is based on the average flow path length for all inlets.

Embankments

Embankments are earthen slopes or berms used to detain or redirect the flow of water. For infiltration basins, the embankments must be design with the following specifications:

- All earthworks must be conducted in accordance with the Standard Specifications for Public Works Construction.
- The minimum top width of all berm embankments must be 20 feet, unless otherwise approved by GMED.
- Berm embankments must be constructed on native consolidated soil or adequately compacted and stable fill soils approved by a licensed geotechnical engineer. Soils must be free of loose surface soil materials, roots, and other organic debris.
- Berm embankments must be constructed of compacted soil (95 percent minimum dry density, Modified Proctor method per ASTM D1557) and placed in 6-inch lifts.
- Berm embankments greater than 4 feet in height must be constructed by excavating a key equal to 50 percent of the berm embankment cross-sectional height and width. This requirement may be waived if specifically recommended by a licensed geotechnical engineer.
- Low growing native or non-invasive perennial grasses must be planted on downstream embankment slopes. See Attachment B of the Vegetation Management on Embankment Dams of Public Works' Debris Control Facilities for a recommended plant list.

Sizing

Infiltration basins are sized using a simple sizing method where the SWQDv must be completely infiltrated within 96 hours. Infiltration basins provide stormwater runoff storage above ground.

Step 1: Determine the SWQDv

Infiltration basins must be designed to capture and retain the SWQDv (see Section 6 for SWQDv calculation procedures).

Step 2: Determine the design infiltration rate

Determine the corrected in-situ infiltration rate (f_{design}) of the native soil using the procedures described in the most recent GMED Policy GS 200.1.

Step 3: Calculate the surface area

Determine the required size of the infiltration surface by assuming the SWQDv will fill the available ponding depth. The maximum depth of stormwater runoff that can be infiltrated within the maximum retention time (96 hrs) is calculated using the following equation:

$$d_{max} = \frac{f_{design}}{12} \times t$$

Where:

d_{max} = Maximum depth of water that can be infiltrated within the required drawdown time [ft];

f_{design} = Design infiltration rate [in/hr]; and

t = Maximum detention time (max 96 hrs) [hr].

Select the ponding depth (d_p) such that:

$$d_{max} \geq d_p$$

Where:

d_{max} = Maximum depth of water that can be infiltrated within the maximum retention time [ft]; and

d_p = Ponding depth (max 1.5 ft) [ft].

Calculate the infiltrating surface area (bottom of the infiltration basin) required:

$$A = \frac{SWQDv}{d_p}$$

Where:

A = Surface area of the bottom of the infiltration basin [ft²];
SWQDv = Stormwater quality design volume [ft³]; and
d_p = Ponding depth [ft].

Flow Entrance and Energy Dissipation

Energy dissipation controls, constructed of sound materials such as stones, concrete, or proprietary devices that are rated to withstand the energy of the influent flow, must be installed at the inlet to the infiltration basin or its forebay. Flow velocity at the inlet must be 4 ft/s or less. Consult with LACDPW for the type and design of energy dissipation structure.

Drainage

The specifications for designing drainage systems for infiltration basins are presented below:

- The bottom of infiltration basin must be native soil that is over-excavated at least one foot in depth with the soil replaced uniformly without compaction. Amending excavated soil with two to four inches (~15 to 30 percent) of coarse sand is recommended.
- The use of vertical piping, either for distribution or infiltration enhancement, is prohibited. This application may be classified as a Class V Injection Well per 40 CFR Part 146.5(e)(4).
- The infiltration capacity of the subsurface layers should be sufficient to ensure a maximum retention time of 96 hours.

Hydraulic Restriction Layer

Lateral infiltration pathways may need to be restricted due to the close proximity of roads, foundations, or other infrastructure. A geomembrane liner, or other equivalent waterproofing, may be placed along the vertical walls to reduce lateral flows. The geomembrane liner must have a minimum thickness of 30 mils and meet the requirements of Table E-13. Generally, waterproof barriers must not be placed at the bottom of the bioretention area as it would prevent incidental infiltration which is important to meeting the required on-site retention requirement.

Table E-3. Geomembrane Liner Specifications for Bioretention Areas

Parameter	Test Method	Specifications
Material		Non-woven geomembrane liner
Unit weight		8 oz/yd ³ (minimum)
Filtration rate		0.08 in/sec (minimum)
Puncture strength	ASTM D-751 (Modified)	125 lbs (minimum)
Mullen burst strength	ASTM D-751	400 lb/in ² (minimum)
Tensile strength	AST D-1682	300 lbs (minimum)
Equiv. opening size	US Standard Sieve	No. 80 (minimum)

Vegetation

- A thick mat of drought-tolerant grass should be established on the infiltration basin floor and side-slopes following construction. Grasses can help prevent erosion and increase evapotranspiration, and their rhizomes discourage compaction within the root zone to help maintain infiltration rates. Additionally, active growing vegetation can help break up surface crusts that accumulate from sedimentation of fine particulates.
- Grass may need to be irrigated during establishment.
- The infiltration basin will not be accepted by LACDPW until vegetation is well-established and functioning.

Exterior Landscaping

Landscaping outside of the infiltration basin, but within the easement/right-of-way, is required and must adhere to the following specifications such that it will not hinder maintenance operations:

- Trees or shrubs may not be planted within ten feet of inlet or outlet pipes or manmade drainage structures such as spillways, flow spreaders, or earthen embankments. Species with roots that seek water, such as willow or poplar, may not be planted within 50 feet of pipes or manmade structures. Weeping willow (*Salix babylonica*) may not be planted in or near infiltration basins.
- Non-native plant species are not permitted.
- Other resources for identifying suitable plant types can be found by consulting a nursery, arborist, landscape architect, or referring to online resources such as:
 - Calflora (<http://calflora.org>), which is a database of wild California plants that include plant characteristics and photos.
 - Los Angeles River Master Plan Landscaping Guidelines and Plant Palettes (http://ladpw.org/wmd/watershed/LA/LAR_planting_guidelines_webversion)

- .pdf), which is a guidance document providing a listing of native plant communities in the Los Angeles area.
- The Jepson Online Interchange California Floristics (<http://ucjeps.berkeley.edu/interchange.html>), which is a database that provides information on identification, taxonomy, distribution, ecology, relationships, and diversity of California vascular plants.
 - VegSpec (<http://catalog.data.gov/dataset/vegspec>), which is a web-based decision support system that assists land managers in the planning and design with vegetative establishment practices.
 - United States Department of Agriculture (<http://plants.usda.gov/java>), which is an extensive database of native and non-native plants of the United States with over 100 plant characteristics.

Restricted Construction Materials

Use of pressure-treated wood or galvanized metal at or around an infiltration basin is prohibited.

Overflow Device

An overflow device must be provided in the event that stormwater runoff overtops the infiltration basin or if the infiltration basin becomes clogged. The overflow device must be able to convey stormwater runoff to a downstream conveyance system or other acceptable discharge point.

Maintenance Access

Maintenance access must be provided to the drainage structures associated with the infiltration basin (e.g., inlet, overflow or bypass devices) if it is publicly-maintained. Manhole and catch basin lids must be in or at the edge of the access road. An access ramp to the infiltration basin bottom is required to facilitate the entry of sediment removal and vegetation maintenance equipment without compacting the bottom and side slopes of the infiltration basin.

Access roads must meet the following design specification:

- All access ramps and roads must be paved with a minimum of six inches of concrete over three inches of crushed aggregate base material. This requirement may be modified depending on the soil conditions and intended use of the road at the discretion of LACDPW.
- The maximum grade is 12 percent unless otherwise approved by LACDPW.
- Centerline turning radius must be a minimum of 40 feet.
- Access roads less than 500 feet long must have a 12-foot wide pavement within a minimum 15-foot wide bench. Access roads greater than 500 feet long must have a 16-foot wide pavement within a minimum 20-foot wide bench.

- All access roads must terminate with turnaround areas of 40-feet by 40-feet. A hammer type turnaround area or a circle drive around the top of the infiltration basin is also acceptable.
- Adequate double-drive gates and commercial driveways are required at street crossings. Gates must be located a minimum of 25 feet from the street curb except in residential areas where the gates may be located along the property line provided there is adequate sight distance to see oncoming vehicles at the posted speed limit.

Maintenance Requirements

Maintenance and regular inspections are important for proper function of infiltration basins. The following are general maintenance requirements:

- Conduct regular inspection and routine maintenance for pretreatment devices.
- Inspect infiltration basin frequently to ensure that water infiltrates into the subsurface completely within maximum detention time of 96 hours. If water is present in the infiltration basin more than 96 hours after a major storm, the infiltration basin may be clogged. Maintenance activities triggered by a potentially clogged facility include:
 - Check for debris/sediment accumulation, rake surface and remove sediment (if any), and evaluate potential sources of sediment and vegetative or other debris (i.e., embankment erosion, channel scour, overhanging trees). If suspected upstream sources are outside of the County's jurisdiction, additional pretreatment (i.e., trash racks, vegetated swales) may be necessary.
 - Determine if it is necessary to remove the top layer of native soil to restore infiltrative capacity.
- Remove and dispose of trash and debris, as needed, but at least prior to the beginning of the wet season.
- Eliminate standing water to prevent vector breeding.
- Maintain vegetation as needed to sustain the aesthetic appearance of the site, and as follows:
 - Prune and/or remove vegetation, large shrubs, or trees that limit access or interfere with operation of the infiltration basin.
 - Mow grass to four to nine inches high and remove grass clippings.
 - Rake and remove fallen leaves and debris from deciduous plant foliage.
 - Remove and replace invasive vegetation with native vegetation. Invasive species should never contribute more than 25 percent of the vegetated area. For more information on invasive weeds, including biology and control of listed weeds, look at the "encycloveedia" located at the California Department of Food and Agriculture website

(http://www.cdfa.ca.gov/plant/ipc/encycloweedia/encycloweedia_hp.htm) or the California Invasive Plant Council website (www.cal-ipc.org).

- Remove dead vegetation if it exceeds 10 percent of area coverage. Replace vegetation immediately to maintain cover density and control erosion where soils are exposed.
- Do not use herbicides or other chemicals to control vegetation
- If a sediment forebay is used, remove sediment buildup exceeding 50 percent of the sediment storage capacity, as indicated by the steel markers. Remove sediment from the rest of the infiltration basin when it accumulates six inches. Test removed sediments for toxic substance accumulation in compliance with current disposal requirements if visual or olfactory indications of pollution are noticed. If toxic substances are detected at concentrations exceeding thresholds of Title 22, Section 66261 of the California Code of Regulations, dispose of the sediment in a hazardous waste landfill and investigate and mitigate the source of the contaminated sediments to the maximum extent possible.
- Re-establish vegetation, which may require replanting and/or reseeding, following sediment removal activities.
- Inspect overflow devices for obstructions or debris, which should be removed immediately. Repair or replace damaged pipes upon discovery.

A summary of potential problems that need to be addressed by maintenance activities is presented in Table E-4.

The County requires execution of a maintenance agreement to be recorded by the property owner for the on-going maintenance of any privately-maintained stormwater quality control measures. The property owner is responsible for compliance with the maintenance agreement. A sample maintenance agreement is presented in Appendix H.

Table E-4. Infiltration Basin Troubleshooting Summary

Problem	Conditions When Maintenance Is Needed	Maintenance Required
Vegetation	Overgrown vegetation	Mow and trim vegetation to prevent establishment of woody vegetation, and for aesthetics and vector control reasons.
	Presence of invasive, poisonous, nuisance, or noxious vegetation or weeds	Remove this vegetation.
	Excessive loss of turf or ground cover	Replant and/or reseed as needed.
Trash and Debris	Trash and debris > 5 ft ³ /1,000 ft ²	Remove and dispose of trash and debris.
Contaminants and Pollution	Any evidence of oil, gasoline, contaminants, or other pollutants	Remove any evidence of visual contamination.
Erosion	Undercut or eroded areas at inlet structures	Repair eroded areas and re-grade if necessary.
Sediment Accumulation	Accumulation of sediment, debris, and oil/grease in forebay, pretreatment devices, surface, inlet, or overflow structures	Remove sediment, debris, and/or oil/grease.
Water Drainage Rate	Standing water	Remove the top layer of the infiltration basin bottom if necessary.

RET-3: Infiltration Trench



Description

An infiltration trench is a narrow trench constructed in naturally pervious soils designed for retaining and infiltrating stormwater runoff into the underlying native soils and groundwater table. Infiltration trenches are typically filled with gravel and sand, although use of manufactured percolation tank modules may be considered in place of gravel fill. Infiltration trenches provide stormwater runoff treatment through a variety of natural mechanisms (i.e., filtration, adsorption,

biological degradation) as water flows through the soil profile.

Infiltration trenches differ from infiltration basins in that the former are used for small drainage areas and stores stormwater runoff out of sight underground within the void spaces of rocks or stones or percolation tank modules. Infiltration basins are used for larger drainage areas and stormwater is stored within a visible ponded surface.

Infiltration vaults and infiltration leach fields are subsurface variations of the infiltration trench concept in which stormwater runoff is distributed to the upper zone of the subsurface gravel bed by means of perforated pipes.

A schematic of a typical infiltration trench is presented in Figure E-3.

LID Ordinance Requirements

Infiltration trenches can be used to meet the on-site retention requirements of the LID Ordinance. Infiltration trenches will prevent pollutants in the SWQDv from being discharged off-site.

Advantages

- Reduces or eliminates stormwater runoff discharge to receiving water for most storm events
- Reduces peak stormwater runoff, which provides erosion control
- Provides groundwater recharge
- Provides effective treatment through settling and filtering while requiring relatively small space.
- Fits in narrow areas and unused areas of a development site.
- Is suitable for use when water is not available for irrigation or base flow.

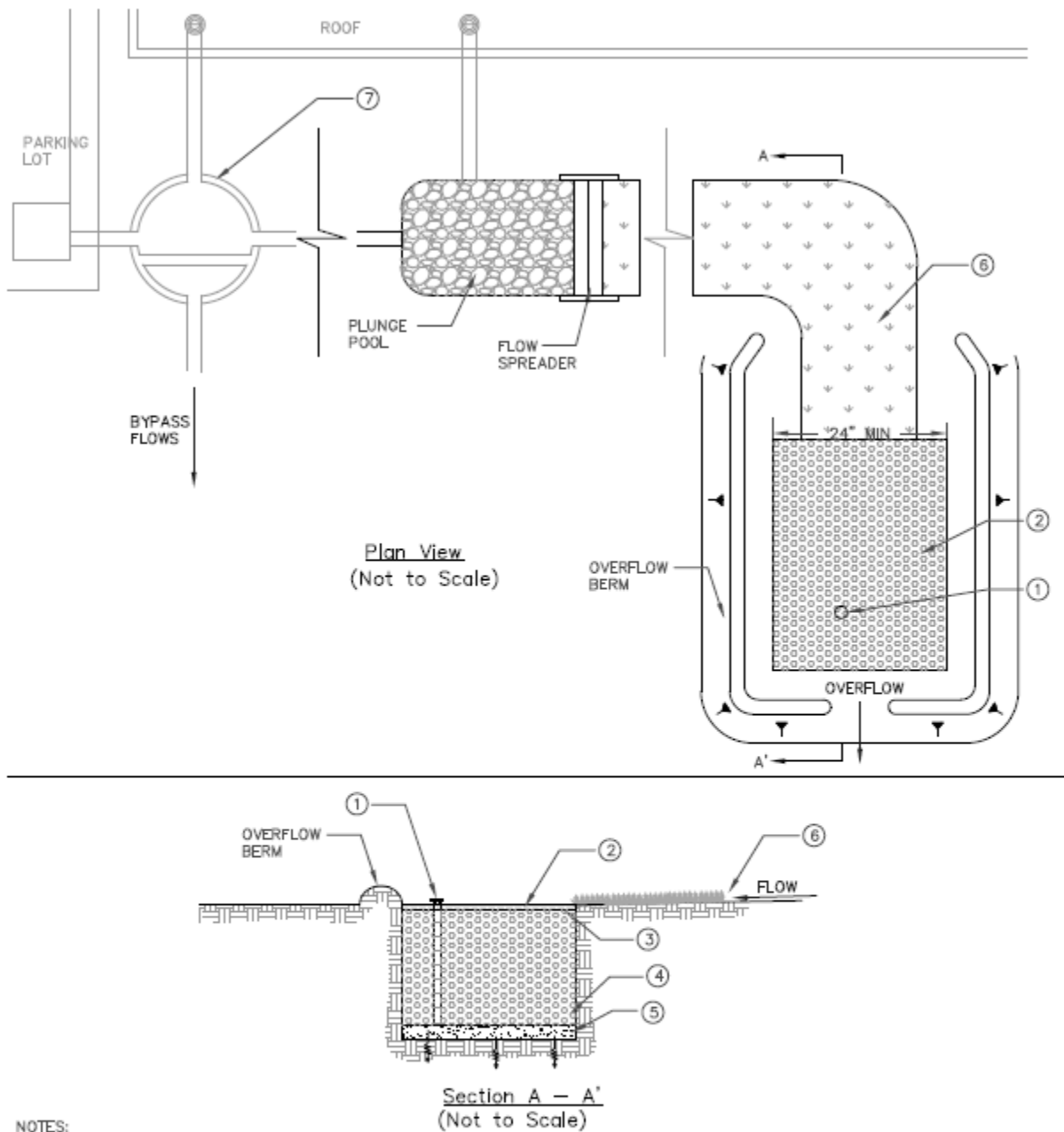

NOTES:

- ① OBSERVATION WELL WITH LOCKABLE ABOVE-GROUND CAP
- ② 2" PEA GRAVEL FILTER LAYER
- ③ PROVIDE FILTER FABRIC IF NO PRETREATMENT IS PROVIDED
- ④ 3' - 5' DEEP TRENCH FILLED WITH 2" - 6" DIAMETER CLEAN STONE WITH 30% - 40% VOIDS
- ⑤ 6" DEEP SAND FILTER LAYER (OR FABRIC EQUIVALENT)
- ⑥ RUNOFF FILTERS THROUGH GRASS FILTER STRIP OR VEGETATED SWALE
- ⑦ OPTIONAL FLOW CONTROL DEVICE FOR OFF-LINE CONFIGURATIONS

Figure E-3. Infiltration Trench Schematic

Disadvantages

- Is not appropriate for areas with too low or too high permeability soils
- May not be appropriate for industrial sites or locations with contaminated soils or where spills may occur because of the potential threat to groundwater contamination
- Must be protected from high sediment loads
- May result in standing water, which may allow vector breeding
- Is not appropriate on fill or sites with steep slopes

General Constraints and Implementation Considerations

- Infiltration trenches can be integrated into open space buffers and other landscape areas.
- The potential for groundwater contamination must be carefully considered,. Infiltration trenches are not suitable for sites that:
 - Use or store chemicals or hazardous materials, unless they are prevented from entering the trench; or
 - Un-remediated “brownfield sites” where there is known groundwater or soil contamination.
- Infiltration trenches should be sited away from tree drip lines and kept free of vegetation.
- If the corrected in-situ infiltration rate exceed 2.4 in/hr, then stormwater runoff may need to be fully-treated with an upstream stormwater quality control measure prior to infiltration to protect groundwater quality.
- Infiltration trenches cannot be located on sites with a slope greater than 15 percent.
- Pretreatment to remove sediment is required to protect infiltration trench from high sediment loads.
- If possible, the entire tributary area of the infiltration trench should be stabilized before construction begins. If this is not possible, all flows should be diverted around the infiltration trench to protect it from sediment loads during construction or the top two inches of soil from the infiltration trench floor should be removed after the site has been stabilized. Excavated material should be stored such that it cannot be washed back into the infiltration trench if a storm occurs during construction.
- The equipment used to construct the infiltration trench should have extra wide low-pressure tires. Construction traffic should not enter the infiltration trench because it can compact soil, which reduces infiltration capacity. If heavy equipment is used on the base of the infiltration trench, the infiltrative capacity may be restored by tilling or aerating prior to placing the infiltrative bed.

- Clean, washed gravel should be placed in the excavated trench in lifts and lightly compacted with a plate compactor. Use of unwashed gravel can result in clogging.
- A geomembrane liner should be installed generously with overlapping seams on sides, bottom, and one foot below the surface of the infiltration trench.
- After construction is completed, the entire tributary area of the infiltration trench should be stabilized before allowing stormwater runoff to enter it.
- An observation well must be installed to check water levels, detention time, and evidence of clogging. An access road along the entire length of the infiltration trench is required unless it is located along an existing road or parking lot that can be safely used for maintenance access.

Design Specifications

The following sections provide design specifications for infiltration trenches.

Geotechnical

Due to the potential to contaminate groundwater, cause slope instability, impact surrounding structures, and potential for insufficient infiltration capacity, an extensive geotechnical site investigation must be conducted during the site planning process to verify site suitability for an infiltration trench. All geotechnical investigations must be performed according to the most recent GMED Policy GS 200.1. Soil infiltration rates and the groundwater table depth must be evaluated to ensure that conditions are satisfactory for proper operation of an infiltration trench. The project applicant must demonstrate through infiltration testing, soil logs, and the written opinion of a licensed civil engineer that sufficiently permeable soils exist on-site to allow the construction of a properly functioning infiltration trench.

Infiltration trenches are appropriate for soils with a minimum corrected in-situ infiltration rate of 0.3 in/hr. The geotechnical report must determine if the proposed project site is suitable for an infiltration trench and must recommend a design infiltration rate (see “Design Infiltration Rate” under the “Sizing” section). The geotechnical investigation should be such that a good understanding is gained as to how the stormwater runoff will move through the soil (horizontally or vertically) and if there are any geological conditions that could inhibit the movement of water.

Pretreatment

Pretreatment is important for all structural stormwater quality control measures, but it is particularly important for retention facilities. Pretreatment refers to design features that provide settling of large particles before stormwater runoff enters a stormwater quality control measure in order to reduce the long-term maintenance burden. Pretreatment should be provided to reduce the sediment load entering an infiltration trench in order to maintain the infiltration rate of the infiltration trench. To ensure that infiltration trenches are effective, the project applicant must incorporate pretreatment devices that provide

sediment reduction (e.g., vegetated swales, vegetated filter strips, sedimentation manholes, and proprietary devices).

Setbacks

Infiltration trenches must be sited following the setbacks from the most recent GMED Policy GS 200.1.

Geometry

- Infiltration trenches must be designed and constructed to be at least 24 inches wide and 3 to 5 feet deep.
- The longitudinal slope of the trench should not exceed three percent.
- The filter bed media layers must have the following composition and thickness:
 - Top layer: 2 inches of pea gravel
 - Middle layer: 3 to 5 feet of washed 2- to 6-inch gravel; void spaces should be approximately 30 to 40 percent
 - Bottom layer: 6 inches of sand or geomembrane liner equivalent.

Sizing

Infiltration trenches are sized a simple sizing method where the SWQDv must be completely infiltrated within 96 hours. Infiltration trenches provide stormwater runoff storage in the voids of the rock fill or percolation tank modules.

Step 1: Determine the SWQDv

Infiltration trenches must be designed to capture and retain the SWQDv (see Section 6 for SWQDv calculation procedures).

Step 2: Determine the design infiltration rate

Determine the corrected in-situ infiltration rate (f_{design}) of the native soil using the procedures described in the most recent GMED Policy GS 200.1.

Step 3: Calculate the surface area

Determine the size of the required infiltration surface by assuming the SWQDv will fill the available void spaces of the gravel storage layer. The maximum depth of stormwater runoff that can be infiltrated within the maximum retention time (96 hrs) is calculated using the following equation:

$$d_{max} = \frac{f_{design}}{12} \times t$$

Where:

d_{max} = Maximum depth of water that can be infiltrated within the maximum retention time [ft];
 f_{design} = Design infiltration rate [in/hr]; and
 t = Maximum retention time (max 96 hrs) [hr].

Select the infiltration trench depth (d_t) such that:

$$d_t \leq \frac{d_{max}}{n_t}$$

Where:

d_t = Depth of infiltration trench [ft];
 d_{max} = Maximum depth of water that can be infiltrated within the maximum retention time [ft]; and
 n_t = Infiltration trench fill porosity.

Calculate the infiltrating surface area (bottom of the infiltration trench) required:

$$A = \frac{SWQDv}{d_t \times n_t}$$

Where:

A = Surface area of the bottom of the infiltration trench [ft²];
 $SWQDv$ = Stormwater quality design volume [ft³];
 d_t = Depth of infiltration trench fill [ft]; and
 n_t = Infiltration trench porosity.

Flow Entrance and Energy Dissipation

Energy dissipation controls, constructed of sound materials such as stones, concrete, or proprietary devices that are rated to withstand the energy of the influent flow, must be installed at the inlet to the infiltration trench. Flow velocity at the inlet must be 4 ft/s or less. Consult with LACDPW for the type and design of energy dissipation structure.

Drainage

The specifications for designing drainage systems for infiltration trenches are presented below:

- The bottom of infiltration trench must be native soil that is over-excavated at least one foot in depth with the soil replaced uniformly without compaction. Amending the excavated soil with two to four inches (~15 to 30 percent) of coarse sand is recommended.

- The use of vertical piping, either for distribution or infiltration enhancement, is prohibited. This application may be classified as a Class V Injection Well per 40 CFR Part 146.5(e)(4).
- The infiltration capacity of the subsurface layers should be sufficient to ensure a maximum detention time of 96 hours. An observation well must be installed to allow observation of detention time.

Hydraulic Restriction Layer

The entire infiltrative area, including the side slopes must lined with a geomembrane liner to prevent soil from migrating into the top layer and reducing the infiltration capacity. The specifications of the geomembrane liner are presented in Table E-5. The entire trench area, including the sides, must be lined with a geomembrane liner prior to placing the media bed. Provide generous overlap at the seams.

Table E-5. Geomembrane Liner Specifications for Infiltration Trenches

Parameter	Test Method	Specifications
Material		Nonwoven geomembrane liner
Unit weight		8 oz/yd ³ (minimum)
Filtration rate		0.08 in/sec (minimum)
Puncture strength	ASTM D-751 (Modified)	125 lbs (minimum)
Mullen burst strength	ASTM D-751	400 lb/in ² (minimum)
Tensile strength	AST D-1682	300 lbs (minimum)
Equiv. opening size	US Standard Sieve	No. 80 (minimum)

Observation Well

The observation well is a vertical section of perforated PVC pipe, four- to six-inch diameter, installed flush with the top of the infiltration trench on a footplate and with a locking, removable cap. The observation well is needed to monitor the infiltration rate in infiltration trench and is useful for marking the location of the infiltration trench.

Vegetation

- Infiltration trenches must be kept free of vegetation.
- Trees and other large vegetation should be planted away from infiltration trenches such that drip lines do not overhang the infiltration area.

Restricted Construction Materials

Use of pressure-treated wood or galvanized metal at or around an infiltration trench is prohibited.

Overflow Device

An overflow device must be provided in the event that stormwater runoff overtops the infiltration trench or if the infiltration trench becomes clogged. The overflow device must be able to convey stormwater runoff to a downstream conveyance system or other acceptable discharge point.

Maintenance Access

The infiltration trench must be safely accessible during wet and dry weather conditions if it is publicly-maintained. An access road along the entire length of the infiltration trench is required unless the trench is located along an existing road or parking lot that can be safely used for maintenance access. If the infiltration trench becomes plugged and fails, access is needed to excavate the infiltration trench and replace the filter bed media. All dimensions of the infiltration trench should also be increased by two inches to provide a fresh surface for infiltration. To prevent damage and compaction, access must be able to accommodate a backhoe working at “arm’s length” from the infiltration trench.

Maintenance Requirements

Maintenance and regular inspections are important for proper function of infiltration trenches. The following are general maintenance requirements:

- Conduct regular inspection and routine maintenance for pretreatment devices.
- Inspect infiltration trench and its observation well frequently to ensure that water infiltrates into the subsurface completely within the maximum detention time of 96 hours. If water is present in the observation well more than 96 hours after a major storm, the infiltration trench may be clogged. Maintenance activities triggered by a potentially clogged facility include:
 - Check for debris/sediment accumulation, rake surface and remove sediment (if any), and evaluate potential sources of sediment and vegetative or other debris (i.e., embankment erosion, channel scour, overhanging trees). If suspected upstream sources are outside of the County's jurisdiction, additional pretreatment (i.e., trash racks, vegetated swales) may be necessary.
 - Assess the condition of the top aggregate layer for sediment buildup and crusting. Remove the top layer of pea gravel and replace. If slow draining conditions persist, the entire infiltration trench may need to be excavated and replaced.
- Eliminate standing water to prevent vector breeding.
- Inspect infiltration trenches annually. Remove and dispose of trash and debris as needed, but at least prior to the beginning of the wet season.
- Inspect overflow devices for obstructions or debris, which should be removed immediately. Repair or replace damaged pipes upon discovery.

A summary of potential problems that may need to be addressed by maintenance activities is presented in Table E-6.

The County requires execution of a maintenance agreement to be recorded by the property owner for the on-going maintenance of any privately-maintained stormwater quality control measures. The property owner is responsible for compliance with the maintenance agreement. A sample maintenance agreement is presented in Appendix H.

Table E-6. Infiltration Trench Troubleshooting Summary

Problem	Conditions When Maintenance Is Needed	Maintenance Required
Trash and Debris	Trash and debris > 5 ft ³ /1,000 ft ²	Remove and dispose of trash and debris.
Contaminants and Pollution	Any evidence of oil, gasoline, contaminants, or other pollutants	Remove any evidence of visual contamination.
Erosion/Sediment Accumulation	Undercut or eroded areas at inlet structures	Repair eroded areas and re-grade if necessary.
	Accumulation of sediment, debris, and oil/grease in pretreatment devices	Remove sediment, debris, and/or oil/grease.
	Accumulation of sediment, debris, and oil/grease on surface, inlet or overflow structures	Remove sediment, debris, and/or oil/grease.
Water Drainage Rate	Standing water, or by inspection of observation wells	Remove the top layer of the infiltration trench bottom and replace if necessary.

RET-4: Dry Well



Description

A dry well is a bored, drilled, or driven shaft or hole whose depth is greater than its width. A dry well may either be a small excavated pit filled with aggregate or a prefabricated storage chamber or pipe segment. Dry well design and function are similar to infiltration trenches in that they are designed to temporarily store and subsequently infiltrate stormwater runoff. In particular, dry wells can be used to reduce the volume of stormwater runoff from building roofs. While generally not a significant source of stormwater runoff

pollution, roofs are one of the most important sources of new or increased stormwater runoff volume from land development sites. Dry wells can be used to indirectly enhance water quality by reducing the volume of stormwater runoff to be treated by other downstream stormwater quality control measures.

A schematic of a typical dry well is presented in Figure E-4.

LID Ordinance Requirements

Dry wells can be used to meet the on-site retention requirements of the LID Ordinance. Dry wells will prevent pollutants in the SWQDv from being discharged off-site.

Advantages

- Requires minimal space to install
- Low installation costs
- Provide groundwater recharge
- Reduces peak stormwater runoff flows during small storm events

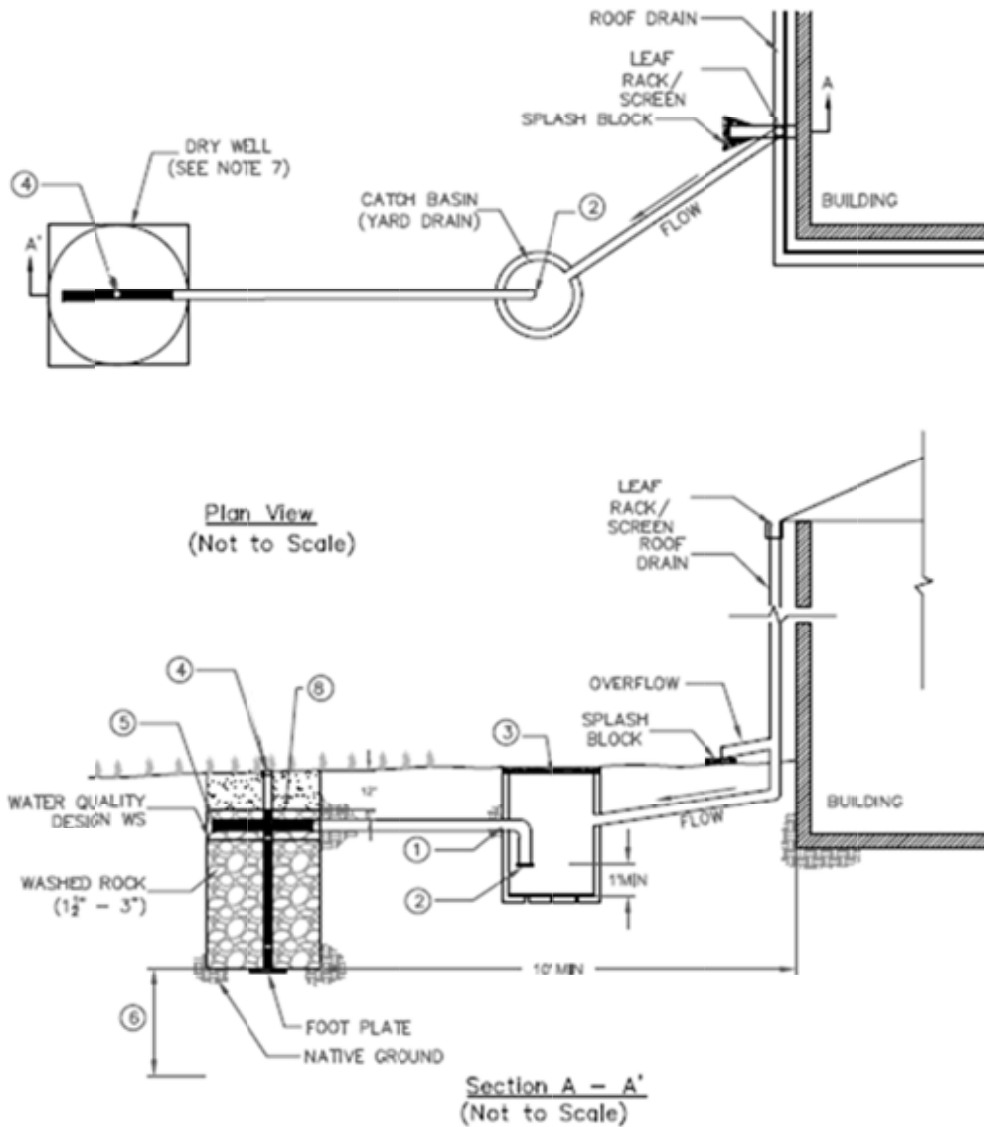

NOTES:

- ① MINIMUM 4" - 6" DIAMETER PVC PIPE. INSTALL AT FLAT SLOPE.
- ② INSTALL FINE MESH SCREEN AT INLET TO DRY WELL. SET INLET ELEVATION AT 1' MINIMUM ABOVE CATCH BASIN BOTTOM.
- ③ CATCH BASIN (YARD DRAIN) INSTALLED WITH A SOLID LID FLUSH WITH GROUND SURFACE.
- ④ 4-6" VERTICAL PERFORATED PVC INSPECTION WELL WITH SCREW LID (NUT DOWN) FLUSH WITH GROUND SURFACE.
- ⑤ CAP END OF 4-6" HORIZONTAL PERFORATED PVC DISPERSION PIPE.
- ⑥ MINIMUM 10' ABOVE SEASONAL HIGH GROUNDWATER TABLE AND 3" ABOVE BEDROCK.
- ⑦ DRY WELL CONFIGURATION MAY VARY (E.G. PRE-FAB MAY BE CIRCULAR).
- ⑧ CHOKING STONE LAYER SHALL BE PLACED ON TOP OF THE DRY WELL TO SEPARATE IT FROM THE TOPSOIL AND PREVENT CLOGGING.

Figure E-4. Dry Well Schematic

Disadvantages

- Is not appropriate for areas with low permeability soils or high groundwater levels
- May not be appropriate for industrial sites or locations with contaminated soils or where spills may occur because of the potential threat to groundwater contamination
- Cannot receive untreated stormwater runoff except from rooftops
- Requires complete reconstruction for failed dry wells
- Is not suitable for fill sites or on steep slopes

General Constraints and Implementation Considerations

- Dry wells can be integrated into open space buffers and other landscape areas.
- The potential for groundwater contamination must be carefully considered,. Dry wells are not suitable for sites that:
 - Use or store chemicals or hazardous materials, unless they are prevented from entering the well; or
 - Un-remediated “brownfield sites” where there is known groundwater or soil contamination
- Dry wells should be sited away from tree drip lines and kept free of vegetation.
- If the corrected in-situ infiltration rate exceed 2.4 in/hr, then stormwater runoff may need to be fully-treated with an upstream stormwater quality control measure prior to infiltration to protect groundwater quality.
- Dry wells cannot be located on sites with a slope greater than 20 percent (5:1).
- Pretreatment to remove sediment is required to protect dry wells from high sediment loads.
- If a yard drain is proposed as part of the design, it must be designed so that any standing water in the catch basin will infiltrate within 96 hours.
- If possible, the entire tributary area of the dry well should be stabilized before construction begins. If this is not possible, all flows should be diverted around the dry well to protect it from sediment loads during construction or the top two inches of soil from the dry well bottom should be removed after the site has been stabilized. Excavated material should be stored such that it cannot be washed back into the dry well if a storm occurs during construction.
- The equipment used to construct the dry well should have extra wide low-pressure tires. Construction traffic should not enter the dry well because it can compact soil, which reduces infiltration capacity. If heavy equipment is used on the base of the dry well, the infiltrative capacity may be restored by tilling or aerating prior to placing the infiltrative bed.

- Clean, washed gravel should be placed in the excavated dry well in lifts and lightly compacted with a plate compactor. Use of unwashed gravel can result in clogging.
- A geomembrane liner should be installed generously with overlapping seams on sides, bottom, and one foot below the surface of the dry well.
- Once construction is complete, stabilize the entire tributary area to the dry well before allowing stormwater runoff to enter it.
- An observation well must be installed to check water levels, retention time, and evidence of clogging.
- Accessibility for maintenance during dry and wet weather conditions must be provided.

Design Specifications

The following sections provide design specifications for dry wells.

Geotechnical

Due to the potential to contaminate groundwater, cause slope instability, impact surrounding structures, and potential for insufficient infiltration capacity, an extensive geotechnical site investigation must be conducted during the site planning process to verify site suitability for a dry well. All geotechnical investigations must be performed according to the most recent GMED Policy GS 200.1. Soil infiltration rates and the groundwater table depth must be evaluated to ensure that conditions are satisfactory for proper operation of a dry well. The project applicant must demonstrate through infiltration testing, soil logs, and the written opinion of a licensed civil engineer that sufficiently permeable soils exist on-site to allow the construction of a properly functioning dry well.

Dry wells are appropriate for soils with a minimum corrected in-situ infiltration rate of 0.3 in/hr. The geotechnical report must determine if the proposed project site is suitable for a dry well and must recommend a design infiltration rate (see “Design Infiltration Rate” under the “Sizing” section). The geotechnical investigation should be such that a good understanding is gained as to how the stormwater runoff will move through the soil (horizontally or vertically) and if there are any geological conditions that could inhibit the movement of water.

Pretreatment

Pretreatment is important for all structural stormwater quality control measures, but it is particularly important for retention facilities. Pretreatment refers to design features that provide settling of large particles before stormwater runoff enters a stormwater quality control measure in order to reduce the long-term maintenance burden. Pretreatment should be provided to reduce the sediment load entering a dry well in order to maintain the infiltration rate of the dry well. To ensure that dry wells are effective, the project applicant must incorporate pretreatment devices that provide sediment reduction (e.g.,

vegetated swales, vegetated filter strips, sedimentation manholes, and proprietary devices).

Setbacks

Dry wells must be sited following the setbacks from the most recent GMED Policy GS 200.1.

Geometry

- Dry well configurations vary, but generally have length and width top dimensions close to a square. Prefabricated dry wells are often circular.
- The filter bed media layers must have the following composition and thickness, unless they are prefabricated dry wells:
 - Top layer: 2 inches of pea gravel
 - Middle layer: 3 to 5 feet of washed 2- to 6-inch gravel; void spaces should be approximately 30 to 40 percent
 - Bottom layer: 6 inches of sand or geomembrane liner equivalent.
- Gravel media and prefabricated dry wells have porosities of 30 to 40 percent and 80 to 95 percent, respectively.
- If a dry well receives stormwater runoff from an underground pipe (i.e., stormwater runoff does not enter the top of the dry well from the ground surface), a fine mesh screen should be installed at the inlet. The inlet elevation should be 18 inches below the ground surface (i.e., below 12 inches of surface soil and 6 inches of dry well media).

Sizing

Dry wells are sized using a simple sizing method where the SWQDv must be completely infiltrated within 96 hours. Dry wells provide stormwater runoff storage in the voids of the rock fill.

Step 1: Determine the SWQDv

Dry wells must be designed to capture and retain the SWQDv (see Section 6 for SWQDv calculation procedures).

Step 2: Determine the design infiltration rate

Determine the corrected in-situ infiltration rate (f_{design}) of the native soil using the procedures described in the most recent GMED Policy GS 200.1.

Step 3: Calculate the surface area

Determine the required size of the infiltration surface by assuming the SWQDv will fill the available void spaces of the gravel storage layer. The maximum depth of stormwater runoff that can be infiltrated within the maximum retention time (96 hrs) is calculated using the following equation:

$$d_{max} = \frac{f_{design}}{12} \times t$$

Where:

d_{max} = Maximum depth of water that can be infiltrated within the required drawdown time [ft];

f_{design} = Design infiltration rate [in/hr]; and

t = Maximum retention time (max 96 hrs) [hr].

Select the dry well depth (d_t) such that:

$$d_t \leq \frac{d_{max}}{n_t}$$

Where:

d_t = Depth of dry well fill [ft];

d_{max} = Maximum depth of water that can be infiltrated within the maximum retention time [ft]; and

n_t = Dry well fill porosity.

Calculate the infiltrating surface area (bottom of the dry well) required:

$$A = \frac{SWQDv}{d_t \times n_t}$$

Where:

A = Surface area of the bottom of the dry well [ft²];

SWQDv = Stormwater quality design volume [ft³]; and

d_t = Depth of dry well fill [ft]; and

n_t = Dry well fill porosity.

Flow Entrance and Energy Dissipation

Energy dissipation controls, constructed of sound materials such as stones, concrete, or proprietary devices that are rated to withstand the energy of the influent flow, must be installed at the inlet to the dry well. Consult with LACDPW for the type and design of energy dissipation structure.

Drainage

The specifications for designing drainage systems for dry wells are presented below:

- The bottom of dry well must be native soil that is over-excavated at least one foot in depth with the soil replaced uniformly without compaction. Amending the excavated soil with two to four inches (~15 to 30 percent) of coarse sand is recommended.
- The use of vertical piping, either for distribution or infiltration enhancement, is prohibited. This application may be classified as a Class V Injection Well per 40 CFR Part 146.5(e)(4).
- The infiltration capacity of the subsurface layers should be sufficient to ensure a maximum retention time of 96 hours. An observation well must be installed to allow observation of retention time.

Hydraulic Restriction Layer

The entire infiltrative area, including the side walls must lined with a geomembrane liner to prevent soil from migrating into the top layer and reducing storage capacity. The specifications of the geomembrane liner are presented in Table E-7. The entire well area, including the sides, must be lined with a geomembrane liner prior to placing the media bed. Provide generous overlap at the seams.

Table E-7. Geomembrane Liner Specifications for Dry Wells

Parameter	Test Method	Specifications
Material		Nonwoven geomembrane liner
Unit weight		8 oz/yd ³ (minimum)
Filtration rate		0.08 in/sec (minimum)
Puncture strength	ASTM D-751 (Modified)	125 lbs (minimum)
Mullen burst strength	ASTM D-751	400 lb/in ² (minimum)
Tensile strength	AST D-1682	300 lbs (minimum)
Equiv. opening size	US Standard Sieve	No. 80 (minimum)

Observation Well

The observation well is a vertical section of perforated PVC pipe, four- to six-inch diameter, installed flush with the top of the dry well on a footplate and with a locking, removable cap. The observation well is needed to monitor the infiltration rate in dry well and is useful for marking the location of the dry well.

Vegetation

- Dry wells must be kept free of vegetation.

- Trees and other large vegetation should be planted away from dry well such that drip lines do not overhang the infiltration area.

Restricted Construction Materials

Use of pressure-treated wood or galvanized metal at or around a dry well is prohibited.

Maintenance Access

The dry well must be safely accessible during wet and dry weather conditions if it is publicly-maintained. If the dry well becomes plugged and fails, access is needed to excavate the dry well and replace the filter bed media. To prevent damage and compaction, access must be able to accommodate a backhoe working at “arm’s length” from the dry well.

Maintenance Requirements

Maintenance and regular inspections are important for proper function of dry wells. The following are general maintenance requirements:

- Conduct regular inspection and routine maintenance for pretreatment devices.
- Inspect dry well and its observation well frequently to ensure that water infiltrates into the subsurface completely within maximum retention time of 96 hours. If water is present in the observation well more than 96 hours after a major storm, the dry well may be clogged. Maintenance activities triggered by a potentially clogged facility include:
 - Check for debris/sediment accumulation and remove sediment (if any) and evaluate potential sources of sediment and vegetative or other debris (e.g., embankment erosion, channel scour, overhanging trees, etc). If suspected upstream sources are outside of the County's jurisdiction, additional pretreatment operations (e.g., trash racks, vegetated swales, etc.) may be necessary.
 - Assess the condition of the top aggregate layer for sediment buildup and crusting. Remove the top layer of pea gravel and replace. If slow draining conditions persist, the entire dry well may need to be excavated and replaced.
- Eliminate standing water to prevent vector breeding.
- Remove and dispose of trash and debris as needed, but at least prior to the beginning of the wet season.

A summary of potential problems that may need to be addressed by maintenance activities is presented in Table E-8.

The County requires execution of a maintenance agreement to be recorded by the property owner for the on-going maintenance of any privately-maintained stormwater

quality control measures. The property owner is responsible for compliance with the maintenance agreement. A sample maintenance agreement is presented in Appendix H.

Table E-8. Dry Well Troubleshooting Summary

Problem	Conditions When Maintenance Is Needed	Maintenance Required
Trash and Debris	Trash and debris > 5 ft ³ /1,000 ft ²	Remove and dispose of trash and debris.
Contaminants and Pollution	Any evidence of oil, gasoline, contaminants, or other pollutants	Remove any evidence of visual contamination.
Erosion/Sediment Accumulation	Undercut or eroded areas at inlet structures	Repair eroded areas and re-grade if necessary.
	Accumulation of sediment, debris, and oil/grease in pretreatment devices	Remove sediment, debris, and/or oil/grease.
	Accumulation of sediment, debris, and oil/grease on surface or inlet	Remove sediment, debris, and/or oil/grease.
Water Drainage Rate	Standing water, or by inspection of observation wells	Remove the top layer of the dry well bottom and replace if necessary.

RET-5: Permeable Pavement without an Underdrain

Description

Permeable pavement includes permeable interlocking concrete pavers, pervious concrete, or porous asphalt pavement that is flat in all directions. Permeable pavement can be used to infiltrate stormwater runoff into the porous pavement and sublayers of sand and gravel and subsequently into the underlying soil and groundwater, if present.



Permeable interlocking concrete pavement is comprised of a layer of durable concrete pavers or blocks separated by joints filled with small stones. Pervious concrete is made from carefully controlled amounts of water and cement materials used to create a paste that forms a thick coat around aggregate particles. Unlike conventional concrete, the mixture contains little or no sand, which creates a substantial void content (between 15 and 25 percent). Porous asphalt, or “open-graded” asphalt, pavement contains no fine aggregate particles, which creates void spaces in the pavement and allows water to collect within and drain through the pavement. An alternative approach for permeable pavement is to use stabilized grassy porous pavement, consisting of grass turf reinforced with plastic rings and filter fabric underlain by gravel. Permeable pavement is highly versatile and can be used in place of impermeable asphalt in many situations.

A schematic of a typical permeable pavement system without an underdrain is presented in Figure E-5.

LID Ordinance Requirements

Permeable pavement without an underdrain may be used to comply with the on-site retention requirements of the LID Ordinance for at least its tributary area. The remaining project site SWQDv may need to be routed to other stormwater quality control measures for on-site retention. Permeable pavement without an underdrain will prevent pollutants in the SWQDv from its tributary area from being discharged off-site.

Advantages

- Reduces stormwater runoff volume and peak flows during small storm events
- Can serve functional and aesthetic purposes
- Can reduce heat island effects if light color concrete pavements are used
- Creates dual use for limited space (e.g., parking and stormwater management provided within same space) and can reduce the need and space required for separate stormwater quality control measures

RET-5: Permeable Pavement without an Underdrain

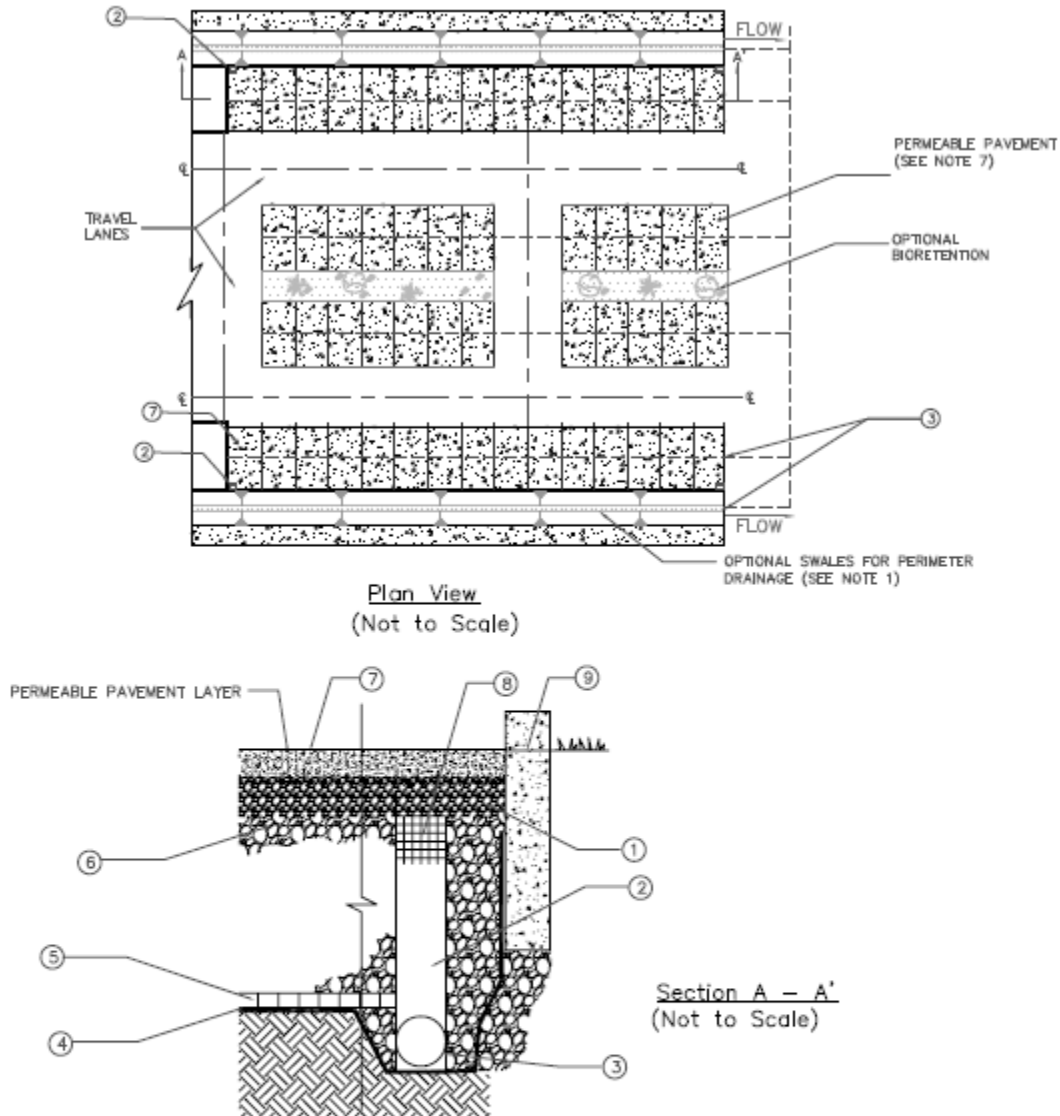

NOTES:

- ① BEDDING COURSE SHALL BE 1½" TO 3" MIN THICKNESS (TYP NO. 8 AGGREGATE).
- ② OPTIONAL OVERFLOW PIPE(S) SHALL BE PROVIDED IF OVERFLOWS ARE NOT MANAGED VIA PERIMETER DRAINAGE TO SWALES, BIORETENTION OR STORM WATER CONVEYANCE SYSTEM INLETS.
- ③ CONNECT OUTFALL PIPES TO DOWNSTREAM STORMWATER CONVEYANCE SYSTEM. OUTFALL PIPES SHALL BE SLOPED TOWARDS COLLECTION SYSTEM.
- ④ SOIL SUBGRADE SHALL HAVE ZERO SLOPE.
- ⑤ INSTALL GEOTEXTILE OR CHINKING LAYER ON BOTTOM & SIDES OF OPEN-GRADED BASE FOR FULL AND PARTIAL INFILTRATION, OR AN IMPERMEABLE LINER FOR NO INFILTRATION.
- ⑥ OPEN-GRADED BASE. THICKNESS AND GRADATION VARIES WITH DESIGN. TYP. NO. 57 AGGREGATE OR 4" THICK NO. 57 OVER NO. 2 STONE SUBBASE. THICKNESS OF SUB-BASE VARIES WITH DESIGN.
- ⑦ PERMEABLE PAVEMENT INFILTRATIVE LAYER
- ⑧ OPTIONAL RIGID PLASTIC SCREEN FASTENED OVER OVERFLOW INLETS.
- ⑨ CURB/EDGE RESTRAINT WITH CUT-OUTS FOR OVERFLOW DRAINAGE TO PERIMETER BMPs, STORMWATER CONVEYANCE SYSTEM INLETS OR OPTIONAL OVERFLOW PIPES.

Figure E-5. Permeable Pavement without an Underdrain Schematic

RET-5: Permeable Pavement without an Underdrain

Disadvantages

- May not be appropriate for industrial sites or locations with contaminated soils or where spills may occur because of the potential threat to groundwater contamination
- Is not appropriate for high turning areas or areas with heavy truck or equipment use
- A sacrificial non-infiltrating area will develop in the transition area between the permeable pavement and natural areas
- Results in an uneven driving surfaces and potential traps for high-heeled shoes
- Requires frequent maintenance to maintain effectiveness due to clogging from sediment if not situated properly
- Has a high cost for restorative maintenance if the system seals with sediment and can no longer function properly as permeable pavement

General Constraints and Implementation Considerations

- Permeable pavement may be used for sidewalks, walkways, and patios.
- Permeable pavement may be used in low vehicle-movement areas. Potential applications may include the following:
 - Low vehicle movement airport zones;
 - Parking aprons and maintenance roads;
 - Crossover/emergency stopping/parking lanes on divided highways;
 - Residential street parking lanes;
 - Residential driveways;
 - Overflow parking; and
 - Emergency vehicle and fire access lanes in apartment/multi-family/complex facilities.
- Permeable pavement must be installed on relatively flat surfaces with slopes less than 10 percent.
- Solid asphalt or concrete pavement for vehicle movement lanes should be used leading up to permeable pavement parking pads.
- Grass may be planted in block voids, but would require irrigation and lawn care.
- If possible, the entire tributary area of the permeable pavement area should be stabilized before construction begins. If this is not possible, all flows should be diverted around the permeable pavement area to protect it from sediment loads during construction.

RET-5: Permeable Pavement without an Underdrain

- The equipment used to construct the permeable pavement should have extra wide low-pressure tires. Construction traffic should not enter the permeable pavement area because it can compact soil, which reduces infiltration capacity.
- Permeable pavement should not be installed during periods of extreme high or low temperatures. The mix should be transported to the project site in clean vehicles with smooth dump beds that have been sprayed with a non-petroleum release agent. The mix should be covered during transit to limit cooling.
- The surface should be compacted when it is cool enough to resist a 9-Mg roller (class equivalent of a 10-ton roller). One or two passes are needed to provide proper compaction. Any additional passes may reduce porosity.
- Vehicular traffic is prohibited until cooling and hardening have taken place, which is no sooner than six hours, but preferably two days.

Design Specifications

Minimum and maximum dimensions and other specifications are product-specific and must comply with manufacturer's recommendations. The following sections provide design specifications for permeable pavement systems without an underdrain.

Geotechnical

Due to the potential to contaminate groundwater, cause slope instability, impact surrounding structures, and potential for insufficient infiltration capacity, an extensive geotechnical site investigation must be conducted during the site planning process to verify site suitability for permeable pavement without an underdrain. All geotechnical investigations must be performed according to the most recent GMED Policy GS 200.1. Soil infiltration rates and the groundwater table depth must be evaluated to ensure that conditions are satisfactory for proper operation of a permeable pavement system. The project applicant must demonstrate through infiltration testing, soil logs, and the written opinion of a licensed civil engineer that sufficiently permeable soils exist on-site to allow the construction of a properly functioning permeable pavement system without an underdrain.

Permeable pavement systems without an underdrain are appropriate for soils with a minimum corrected in-situ infiltration rate of 0.3 in/hr. The geotechnical report must determine if the proposed project site is suitable for a permeable pavement system without an underdrain and must recommend a design infiltration rate (see "Design Infiltration Rate" under the "Sizing" section). The geotechnical investigation should be such that a good understanding is gained as to how the stormwater runoff will move through the soil (horizontally or vertically) and if there are any geological conditions that could inhibit the movement of water.

Setbacks

Permeable pavement must be sited following the setbacks from the most recent GMED Policy GS 200.1.

RET-5: Permeable Pavement without an Underdrain

Sizing

Permeable pavement is sized using a simple sizing method where the SWQDv must be completely infiltrated within 96 hours. Permeable pavement provides stormwater runoff storage in the voids of the sub-base reservoir layer.

Step 1: Determine the SWQDv

Dry wells must be designed to capture and retain the SWQDv (see Section 6 for SWQDv calculation procedures).

Step 2: Determine the design infiltration rate

Determine the corrected in-situ infiltration rate (f_{design}) of the native soil using the procedures described in the most recent GMED Policy GS 200.1.

Step 3: Calculate the surface area

The depth of the sub-base reservoir layer is calculated using the following equation:

$$d_{\text{max}} = \frac{f_{\text{design}}}{12} \times t$$

Where:

d_{max} = Maximum depth of sub-base reservoir layer [ft];
 f_{design} = Design infiltration rate [in/hr];
 t = Maximum retention time (max 96 hrs) [hr]; and

Select the permeable pavement sub-base reservoir layer depth (d_t) such that:

$$d_t \leq \frac{d_{\text{max}}}{n_t}$$

Where:

d_t = Depth of permeable pavement sub-base reservoir layer [ft];
 d_{max} = Maximum depth of water that can be infiltrated within the maximum retention time [ft]; and
 n_t = permeable pavement sub-base reservoir layer porosity.

The required permeable pavement surface area is calculated using the following equation:

$$A_s = \frac{SWQDv}{d_t \times n_t}$$

RET-5: Permeable Pavement without an Underdrain

Where:

A_s = Permeable pavement surface area [ft²];
SWQDv = Stormwater quality design volume [ft³]; and
 d_t = Depth of permeable pavement sub-base reservoir layer [ft]; and
 n_t = Infiltration trench porosity.

Underlying Base Layers

The cross-section of a permeable pavement typically consists of the four layers discussed below:

Asphalt Layer

The surface asphalt layer consists of an open-graded asphalt mixture with a two- to four-inch depth depending on required bearing strength and permeable pavement design requirements. Permeable pavement contains approximately 16 percent voids, compared to 3 to 5 percent for conventional pavements, to allow quick stormwater runoff infiltration.

The asphalt layer must be laid over the top filter layer in one lift. The laying temperature should be between 240 and 260 degrees Fahrenheit with an ambient temperature above 50 degrees Fahrenheit.

Top Filter Layer

The top filter layer, which stabilizes the asphalt layer, consists of one to two inches of 0.5-inch-diameter crushed stone.

Reservoir Layer

The reservoir layer consists of 1.5- to 3-inch crushed stone. The depth of this layer depends on the desired storage volume, which is a function of the infiltration rate, void spaces, and in colder climates the depth of the frost line, but typically ranges from two to four feet. The reservoir layer must be constructed in lifts and lightly compacted. The base courses should be kept free of all dirt and debris during construction. The reservoir layer should be designed to completely drain in 96 hours.

Bottom Filter Layer

This bottom filter layer, which stabilizes the reservoir layer and is the interface between the reservoir layer and the geomembrane liner covering the underlying soil, consists of a two inch thick layer of 0.5-inch crushed stone.

Hydraulic Restriction Layer

The entire area where permeable pavement will be used must be lined with a geomembrane liner to prevent soil from migrating into the reservoir layer and reducing

RET-5: Permeable Pavement without an Underdrain

storage capacity. The specifications of the geomembrane liner are presented in Table E-9. The entire permeable pavement area, including the sides, must be lined with geomembrane liner prior to placing the aggregate. Provide generous overlap at the seams.

Table E-9. Geomembrane Liner Specifications for Permeable Pavement

Parameter	Test Method	Specifications
Material		Nonwoven geomembrane liner
Unit weight		8 oz/yd ³ (minimum)
Filtration rate		0.08 in/sec (minimum)
Puncture strength	ASTM D-751 (Modified)	125 lbs (minimum)
Mullen burst strength	ASTM D-751	400 lb/in ² (minimum)
Tensile strength	AST D-1682	300 lbs (minimum)
Equiv. opening size	US Standard Sieve	No. 80 (minimum)

Overflow Device

Provide an overflow device to convey high stormwater runoff flows to another stormwater quality control measure, the storm drain system, or receiving water, as appropriate. Place the overflow device a maximum of two inches above the level of the permeable pavement surface. Ensure that the two inch ponding depth is contained and does not flow out of the area at the ends or the sides.

Maintenance Requirements

Maintenance and regular inspections are important for proper function of permeable pavement without an underdrain. The following are general maintenance requirements:

- Inspect permeable pavement to determine if stormwater runoff is infiltrating properly at least twice during the wet season after significant storms. If infiltration is significantly reduced, remove surface aggregate by vacuuming. Dispose of and replace old aggregate with fresh aggregate as needed.
- Sweep permeable pavement as needed to clean it of leaves, debris, and sediment. Do not overlay permeable pavement with an impermeable surface.
- Prune vegetation and large shrubs/trees that limit access or interfere with permeable pavement operation. Rake and remove fallen leaves and debris from deciduous plant foliage. Remove poisonous, nuisance, dead, or odor-producing vegetation immediately. Mow grass to less than four inches and bag and remove grass clippings.
- Provide irrigation as needed.
- Exercise spill prevention measures when handling substances that can contaminate stormwater runoff. Implement a spill prevention plan at all non-residential sites and in areas where there is likelihood of spills.

RET-5: Permeable Pavement without an Underdrain

- Eliminate standing water to prevent vector breeding.
- Inspect overflow devices for obstructions or debris, which should be removed immediately. Repair or replace damaged pipes upon discovery.
- Provide safe and efficient access to permeable pavement. Egress and ingress routes must be maintained to design standards. Roadways must be maintained to accommodate size and weight of vehicles if applicable.
- Remove obstacles that may prevent maintenance personnel and/or equipment access to the permeable pavement.
- Limit and control application of pesticides (using Integrated Pest Management practices) and fertilizers to reduce potential pollutant runoff.
- Fill and compact holes in the ground located in and around permeable pavement.
- Identify and control sources of erosion damage when native soil is exposed near the overflow device.
- Add gravel or ground cover if erosion occurs due to vehicular or pedestrian traffic.

A summary of potential problems that may need to be addressed by maintenance activities is presented in Table E-10.

The County requires execution of a maintenance agreement to be recorded by the property owner for the on-going maintenance of any privately-maintained stormwater quality control measures. The property owner is responsible for compliance with the maintenance agreement. A sample maintenance agreement is presented in Appendix H.

RET-5: Permeable Pavement without an Underdrain

Table E-10. Permeable Pavement Troubleshooting Summary

Problem	Conditions When Maintenance Is Needed	Maintenance Required
Vegetation	Overgrown vegetation	Mow and trim vegetation.
	Presence of invasive, poisonous, nuisance, or noxious vegetation or weeds	Remove this vegetation.
	Excessive loss of turf or ground cover	Replant and/or reseed as needed.
Trash and Debris	Trash and debris present	Remove and dispose of trash and debris.
Contaminants and Pollution	Any evidence of oil, gasoline, contaminants, or other pollutants	Remove any evidence of visual contamination.
Erosion/Sediment Accumulation	Eroded areas at overflow structures	Fill eroded areas and re-grade if necessary.
	Accumulation of sediment, debris, and oil/grease on surface, inlet or overflow structures	Remove sediment, debris, and/or oil/grease.
Water Drainage Rate	Standing water	Vacuum aggregate to remove sediment. Replace aggregate if necessary.

RET-6: Rain Barrel/Cistern



Description

Rain barrels and cisterns are containers that collect and store precipitation from rooftop drainage systems that would otherwise be lost to stormwater runoff and diverted to the storm drain system or receiving water. Collection of this precipitation reduces the volume of stormwater runoff and reduces the mobilization of potential pollutants.

Rain barrels are placed above ground beneath a shortened downspout next to a home or building and typically range in size

from 50 to 180 gallons. Cisterns are larger storage tanks that may be located above or below ground. Both cisterns and rain barrels rely on gravity flow, not pumping devices. Rain barrels are equipped with a removable cover to allow access for maintenance, a screened inlet opening to trap debris and exclude vectors, an outlet spigot typically fitted for garden hose attachment, and an overflow outlet with discharge pipe or hose. Stored precipitation is typically used for landscape irrigation, but may also be used for washing. Water stored in rain barrels and cisterns should not be discharged to the storm drain system.

A schematic of a typical rain barrel is presented in Figure E-6.

LID Ordinance Requirements

Rain barrels and cisterns may be used to comply with the on-site retention requirements of the LID Ordinance for at least its tributary rooftop drainage area. The remaining project site SWQDv may need to be routed to other stormwater quality control measures for on-site retention. Rain barrels and cisterns will prevent pollutants in the SWQDv in its tributary rooftop drainage area from being discharged off-site.

Advantages

- Has a low installation cost
- Has a small footprint
- Reduces stormwater runoff volume and pollutant discharge
- Conserves water usage
- Is easy to maintain

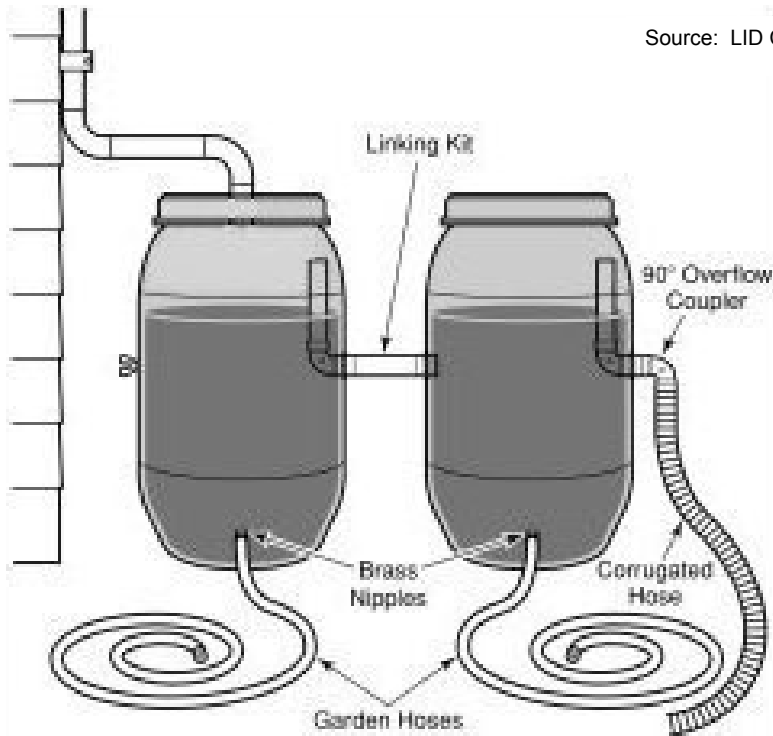

Figure E-6. Rain Barrel Schematic

Disadvantages

- May have limited storage volume
- Collects water that is not suitable for human or pet consumption or contact with fruits/vegetables
- May not be compatible with site aesthetics
- May result in standing water, which may allow vector breeding if not properly covered and maintained
- Requires individual owners/tenants to perform maintenance and empty rain barrels between storms

General Constraints and Implementation Considerations

- Rain barrels and cisterns should be located to allow for easy access and maintenance.
- Rain barrels should be elevated above the ground surface with a sturdy platform to provide spigot clearance.
- Screens or deflectors on rain gutters should be installed to minimize discharge of debris to rain barrels.
- Overflow from cisterns must be directed away from building foundations and to vegetated areas.

Maintenance Requirements

Maintenance and regular inspections are important for proper function of rain barrels and cisterns. Maintenance requirements for rain barrels are minimal and consist only of regular inspection of the unit as a whole and any of its constituent parts and accessories. The following are general maintenance requirements:

- Inspect all components (i.e., roof connection, gutter, downspout, rain barrel/cistern, mosquito screen, overflow pipe) at least twice per year, and repair or replace as needed.
- Clean insect and debris screens as needed.
- Eliminate standing water to prevent vector breeding.

A summary of potential problems that may need to be addressed by maintenance activities is presented in Table E-11.

The County requires execution of a maintenance agreement to be recorded by the property owner for the on-going maintenance of any privately-maintained stormwater quality control measures. The property owner is responsible for compliance with the maintenance agreement. A sample maintenance agreement is presented in Appendix H.

Table E-11: Rain Barrel/Cistern Troubleshooting Summary

Problem	Conditions When Maintenance Is Needed	Maintenance Required
Vector Breeding	Standing water longer than 96 hours after storm event	Empty rain barrel/cistern. Inspect insect screen to determine if it needs to be replaced.
Obstructions	Flow into rain barrel/cistern impeded	Remove obstructions.
Leaks	Leaks observed at roof connection, gutter, downspout, overflow pipe	Replace or repair components as needed. Replace entire rain barrel/cistern if necessary.

BIO-1: Biofiltration



Definition

A biofiltration area is a vegetated shallow depression that is designed to receive and treat stormwater runoff from downspouts, piped inlets, or sheet flow from adjoining paved areas. A shallow ponding zone is provided above the vegetated surface for temporary storage of stormwater runoff. During storm events, stormwater runoff accumulates in the ponding zone and gradually infiltrates the surface and filters through the biofiltration soil media before being collected by an underdrain system.

Stormwater runoff treatment occurs through a variety of natural mechanisms as stormwater runoff filters through the vegetation root zone. In biofiltration areas, microbes and organic material in the biofiltration soil media help promote the adsorption of pollutants (e.g., dissolved metals and petroleum hydrocarbons) into the soil matrix. Plants utilize soil moisture and promote the drying of the soil through transpiration. Biofiltration areas are typically planted with native, drought-tolerant plant species that do not require fertilization and can withstand wet soils for at least 96 hours.

A schematic of a typical biofiltration area is presented in Figure E-7.

LID Ordinance Requirements

Biofiltration can be used as an alternative compliance measure.

Pollutant of Concern	Treated by Biofiltration?
Suspended solids	No
Total phosphorus	No
Total nitrogen	Yes
Total Kjeldahl nitrogen	Yes
Cadmium, total	No
Chromium, total	Yes
Copper, total	No
Lead, total	Yes
Zinc, total	No

Source: Treatment Best Management Practices Performance, Los Angeles Regional Water Quality Control Board, December 9, 2013.

Advantages

- Has a low cost for installation
- Enhances site aesthetics
- Requires little maintenance

Disadvantages

- May require individual owner/tenants to perform maintenance

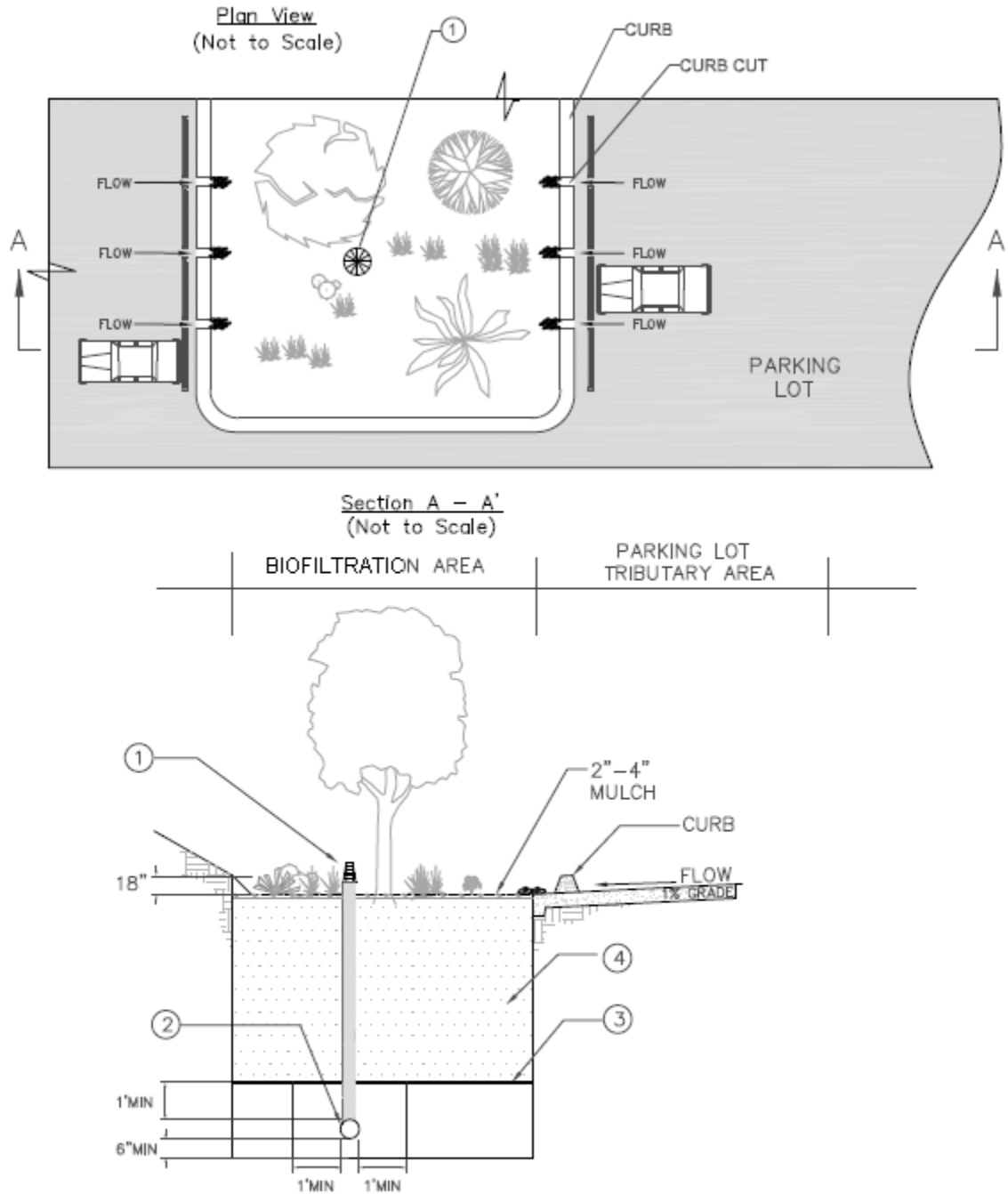

Figure E-7. Biofiltration Area Schematic

General Constraints and Implementation Considerations

- Biofiltration areas can be applied in various settings including, but not limited to:
 - Individual lots for rooftop, driveway, and other on-site impervious surface
 - Shared facilities located in common areas for individual lots
 - Areas within loop roads or cul-de-sacs
 - Landscaped parking lot islands
 - Within right-of-ways along roads
 - Common landscaped areas in apartment complexes or other multi-family housing designs
 - Parks and along open space perimeter
- If tire curbs are provided and parking stalls are shortened, cars are allowed to overhang the biofiltration area.
- Biofiltration areas must be located sufficiently far from structure foundations to avoid damage to structures (as determined by a certified structural or geotechnical engineer).
- Any parking areas bordering the biofiltration area must be monolithically poured concrete or deepened curb concrete to provide structural stability to the adjacent parking section.
- Geomembrane liners must be used in areas subject to spills or pollutant hot spots.
- During construction activities should avoid compaction of native soils below planting media layer or gravel zone.
- Stormwater runoff must be diverted around the biofiltration area during the period of vegetation establishment. If diversion is not feasible, the graded and seeded areas must be protected with suitable sediment controls (i.e., silt fences). All damaged areas should be repaired, seeded, or re-planted immediately.
- The general landscape irrigation system should incorporate the biofiltration area, as applicable.

Design Specifications

The following sections describe the design specifications for biofiltration areas.

Geotechnical

Due to the potential to contaminate groundwater, cause slope instability, impact surrounding structures, and potential for insufficient infiltration capacity, an extensive geotechnical site investigation must be conducted during the site planning process to verify site suitability for biofiltration. All geotechnical investigations must be performed according to the most recent GMED Policy GS 200.1. Soil infiltration rates and the

groundwater table depth must be evaluated to ensure that conditions are satisfactory for proper operation of a biofiltration area. The project applicant must demonstrate through infiltration testing, soil logs, and the written opinion of a licensed civil engineer that sufficiently permeable soils exist on-site to allow the construction of a properly functioning biofiltration system.

Biofiltration areas are appropriate for soils with a minimum corrected in-situ infiltration rate of 0.3 in/hr. The geotechnical report must determine if the proposed project site is suitable for a biofiltration area and must recommend a design infiltration rate (see “Design Infiltration Rate” under the “Sizing” section). The geotechnical investigation should be such that a good understanding is gained as to how the stormwater runoff will move through the soil (horizontally or vertically) and if there are any geological conditions that could inhibit the movement of water.

Pretreatment

Pretreatment refers to design features that provide settling of large particles before stormwater runoff enters a stormwater quality control measure in order to reduce the long-term maintenance burden. Pretreatment should be provided to reduce the sediment load entering a biofiltration area in order to maintain the infiltration rate of the biofiltration area. To ensure that biofiltration areas are effective, the project applicant must incorporate pretreatment devices that provide sediment removal (e.g., vegetated swales, vegetated filter strips, sedimentation manholes, and proprietary devices). The use of at least two pretreatment devices is highly recommended for biofiltration areas.

Geometry

- Biofiltration areas must be sized to capture and treat 1.5 times the SWQDv that is not reliably retained on the project site with an 18-inch maximum ponding depth.
- The planting soil depth must be a minimum of two feet, although three feet is preferred. The planting soil depth should provide a beneficial root zone for the chosen vegetation and adequate water storage for the stormwater runoff. A deeper planting soil depth will also provide a smaller surface area footprint.
- A gravel storage layer below the biofiltration area soil media is required to provide adequate temporary storage to retain 1.5 times the SWQDv that is not reliably retained on the project site and to promote infiltration.

Sizing

Biofiltration areas are sized using a simple sizing method where 1.5 times the SWQDv that is not reliably retained on the project site must be completely filtered within 96 hours. If the incoming stormwater runoff flow rate is lower than the long term filtration rate, above ground storage does not need to be provided. If the incoming stormwater runoff flow rate is higher than the long term filtration rate, above ground storage shall be provided (see steps below).

Step 1: Calculate the design volume

Biofiltration areas should be sized to capture and treat 1.5 times the portion of the SWQDv (see Section 6 for SWQDv calculation procedures) that is not reliability retained on the project site, as calculated by the equation below:

$$V_B = 1.5 \times (SWQDv - V_R)$$

Where:

V_B = Biofiltration volume [ft³];
 $SWQDv$ = Stormwater quality design volume [ft³]; and
 V_R = Volume of stormwater runoff reliably retained on-site [ft³].

Step 2: Calculate the design infiltration rate

Determine the corrected in-situ infiltration rate (f_{design}) of the native soil using the procedures described in the most recent GMED Policy GS 200.1.

Step 3: Calculate the surface area

Select a surface ponding depth (d) that satisfies the geometric criteria and meets the site constraints. Selecting a deeper ponding depth (up to 1.5 ft) generally yields a smaller footprint, however, it will require greater consideration for public safety, energy dissipation, and plant selection.

Calculate the time for the selected ponding depth to filter through the planting media using the following equation:

$$d = t_p \times \frac{f_{\text{design}}}{12}$$

Where:

d = Ponding depth (max 1.5 ft) [ft];
 t_p = Required detention time for surface ponding (max 96 hr) [hr]; and
 f_{design} = Design infiltration rate [in/hr].

If t_p exceeds 96 hours, reduce surface ponding depth (d). In nearly all cases, t_p should not approach 96 hours unless f_{design} is low.

Calculate the required infiltrating surface (filter bottom area) using the following equation:

$$A = \frac{V_B}{d}$$

Where:

A = Bottom surface area of biofiltration area [ft²];
V_B = Biofiltration design volume [ft³]; and
d = Ponding depth (max 1.5 ft) [ft].

Flow Entrance and Energy Dissipation

Maintain a minimum slope of 1 percent for pervious surfaces and 0.5 percent for impervious surfaces to the biofiltration area inlet. The following types of flow entrance can be used for biofiltration cells:

- Level spreaders (i.e., slotted curbs) can be used to facilitate sheet flow.
- Dispersed, low velocity flow across a landscape area. Dispersed flow may not be possible given space limitations or if the biofiltration area is controlling roadway or parking lot flows where curbs are mandatory.
- Dispersed flow across pavement or gravel and past wheel stops for parking areas.
- Flow spreading trench around perimeter of biofiltration area. May be filled with pea gravel or vegetated with 3:1 side slopes similar to a swale. A vertical-walled open trench may also be used at the discretion of LACDPW.
- Curb cuts for roadside or parking lot areas, if approved by LACDPW: curb cuts should include rock or other erosion controls in the channel entrance to dissipate energy. Flow entrance should drop two to three inches from curb line and provide an area for settling and periodic removal of sediment and coarse material before flow dissipates to the remainder of the biofiltration area.
- Piped entrances, such as roof downspouts, should include rock, splash blocks, or other erosion controls at the entrance to dissipate energy and disperse flows.
- Woody plants (trees, shrubs, etc.) can restrict or concentrate flows and can be damaged by erosion around the root ball and must not be placed directly in the entrance flow path.

Drainage

Biofiltration areas must be designed to drain below the planting soil in less than 96 hours. Soils must be allowed to dry out periodically in order to restore hydraulic capacity to receive stormwater runoff from subsequent storm events, maintain infiltration rates, maintain adequate soil oxygen levels for healthy soil biota and vegetation, and provide proper soil conditions for biodegradation and retention of pollutants.

Underdrain

Biofiltration areas require an underdrain to collect and discharge stormwater runoff that has been filtered through the soil media, but not infiltrated, to another stormwater quality control measure, storm drain system, or receiving water. The underdrain must have a mainline diameter of eight inches using slotted PVC SDR 26 or PVC C9000. Slotted PVC allows for pressure water cleaning and root cutting, if necessary. The slotted pipe

should have two to four rows of slots cut perpendicular to the axis of the pipe or at right angles to the pitch of corrugations. Slots should be 0.04 to 0.1 inches wide with a length of 1 to 1.25 inches. Slots should be longitudinally-spaced such that the pipe has a minimum of one square inch opening per lineal foot and should face down.

The underdrain should be placed in a gravel envelope (Class 2 Permeable Material per Caltrans Spec. 68-1.025) that measures three feet wide and six inches deep. The underdrain is elevated from the bottom of the biofiltration area by six inches within the gravel envelope to create a fluctuating anaerobic/aerobic zone below the underdrain to facilitate denitrification within the anaerobic/anoxic zone and reduce nutrient concentrations. The top and sides of the underdrain pipe should be covered with gravel to a minimum depth of 12 inches. The underdrain and gravel envelope should be covered with a geomembrane liner to prevent clogging. The following aggregate should be used for the gravel envelope:

Particle Size (ASTM D422)	% Passing by Weight
¾ inch	100%
¼ inch	30-60%
#8	20-50%
#50	3-12%
#200	0-1%

Underdrains should be sloped at a minimum of 0.5 percent and must drain freely to an approved discharge point.

Rigid non-perforated observation pipes with a diameter equal to the underdrain diameter should be connected to the underdrain to provide a clean-out port as well as an observation well to monitor drainage rates. The wells/clean-outs should be connected to the perforated underdrain with the appropriate manufactured connections. The wells/clean-outs should extend six inches above the top elevation of the biofiltration area mulch, and should be capped with a lockable screw cap. The ends of underdrain pipes not terminating in an observation well/clean-out should also be capped.

Hydraulic Restriction Layer

Lateral infiltration pathways may need to be restricted due to the close proximity of roads, foundations, or other infrastructure. A geomembrane liner, or other equivalent waterproofing, may be placed along the vertical walls to reduce lateral flows. This geomembrane liner must have a minimum thickness of 30 mils and meet the requirements of Table E-12. Generally, waterproof barriers should not be placed on the bottom of the biofiltration unit, as this would prevent incidental infiltration which is important to meeting the required pollutant load reduction.

Table E-12. Geomembrane Liner Specifications for Biofiltration Areas

Parameter	Test Method	Specifications
Material		Nonwoven geomembrane liner
Unit weight		8 oz/yd ³ (minimum)
Filtration rate		0.08 in/sec (minimum)
Puncture strength	ASTM D-751 (Modified)	125 lbs (minimum)
Mullen burst strength	ASTM D-751	400 lb/in ² (minimum)
Tensile strength	AST D-1682	300 lbs (minimum)
Equiv. opening size	US Standard Sieve	No. 80 (minimum)

Planting/Storage Media

- The planting media placed in the biofiltration area should achieve a long-term, in-place infiltration rate of at least 5 in/hr. Higher infiltration rates of up to 12 in/hr are permissible. The biofiltration soil media must retain sufficient moisture to support vigorous plant growth.
- The planting media mix must consist of 60 to 80 percent sand and 20 to 40 percent compost.
- Sand should be free of wood, waste, coatings such as clay, stone dust, carbonate, or any other deleterious material. All aggregate passing the No. 200 sieve size should be non-plastic. Sand for biofiltration should be analyzed by an accredited laboratory using #200, #100, #40, #30, #16, #8, #4, and 3/8 sieves (ASTM D422 or as approved by the local permitting authority) and meet the following gradations (Note: all sand complying with ASTM C33 for fine aggregate comply with the gradation requirements listed below):

Particle Size (ASTM D422)	% Passing by Weight
3/8 inch	100%
#4	90-100%
#8	70-100%
#16	40-95%
#30	15-70%
#40	5-55%
#110	0-15%
#200	0-5%

Note: The gradation of the sand component of the biofiltration soil media is believed to be a major factor in the infiltration rate of the media mix. If the desired hydraulic conductivity of the biofiltration soil media cannot be achieved within the specified proportions of sand and compost (#2), then it may be necessary to utilize sand at the coarser end of the range specified minimum percent passing.

- Compost should be a well-decomposed, stable, weed-free organic matter source derived from waste materials including yard debris, wood wastes, or other organic material not including manure or biosolids meeting standards developed by the USCC. The product shall be certified through the USCC STA Program (a compost testing and information disclosure program). Compost quality shall be verified via a laboratory analysis to be:
 - Feedstock materials must be specified and include one or more of the following: landscape/yard trimmings, grass clippings, food scraps, and agricultural crop residues.
 - pH between 6.5 and 8.0 (may vary with plant palette)
 - Organic Matter: 35 to 75 percent dry weight basis
 - Carbon and Nitrogen Ratio: 15:1 < C:N < 25:1
 - Maturity/Stability: Compost must have a dark brown color and a soil-like odor. Compost exhibiting a sour or putrid smell, containing recognizable grass or leaves, or is hot (120°F) upon delivery or rewetting is not acceptable.
 - Toxicity: any one of the following measures is sufficient to indicate non-toxicity:
 - $\text{NH}_4:\text{NH}_3 < 3$
 - Ammonium < 500 ppm, dry weight basis
 - Seed germination > 80 percent of control
 - Plant trials > 80 percent of control
 - Solvita[®] > 5 index value
 - Nutrient content:
 - Total Nitrogen content ≥ 0.9 percent preferred
 - Total Boron should be < 80 ppm; soluble boron < 2.5 ppm
 - Salinity: < 6.0 mmhos/cm
 - Compost for biofiltration area should be analyzed by an accredited laboratory using #200, ¼-inch, ½-inch, and 1-inch sieves (ASTM D422) and meet the gradation requirements in the table below:

Particle Size (ASTM D422)	% Passing by Weight
1 inch	99-100
½ inch	90-100
¼ inch	40-90
#200	2-10

Tests should be sufficiently recent to represent the actual material that is anticipated to be delivered to the site. If processes or sources used by the supplier have changed significantly since the most recent testing, new tests should be requested.

The gradation of compost used in biofiltration soil media is believed to play an important role in the saturated infiltration rate of the media. To achieve a higher saturated infiltration rate, it may be necessary to utilize compost at the coarser end of the range (minimum percent passing). The percent passing the #200 sieve (fines) is believed to be the most important factor in hydraulic conductivity.

In addition, coarser compost mix provides more heterogeneity of the biofiltration soil media, which is believed to be advantageous for more rapid development of soil structure needed to support healthy biological processes. This may be an advantage for plant establishment with lower nutrient and water input.

- Biofiltration soil media not meeting the above criteria should be evaluated on a case-by-case basis. Alternative biofiltration soil media must meet the following specifications:

“Soils for biofiltration facilities must be sufficiently permeable to infiltrate stormwater runoff at a minimum of rate of 5 in/hr during the life of the facility, and provide sufficient retention of moisture and nutrients to support healthy vegetation.” The following steps shall be followed by LACDPW to verify that alternative biofiltration soil media mixes meet the specification:

- Submittals – The applicant must submit to LACDPW for approval:
 - A sample of mixed biofiltration soil media.
 - Certification from the soil supplier or an accredited laboratory that the biofiltration soil media meets the requirements of this specification.
 - Certification from an accredited geotechnical testing laboratory that the biofiltration soil media has an infiltration rate between 5 and 12 in/hr.
 - Organic content test results of the biofiltration soil media. Organic content test shall be performed in accordance with the Testing Methods for the Examination of Compost and Composting (TMECC) 05.07A, “Loss-On-Ignition Organic Matter Method”.
 - Organic grain size analysis results of mixed biofiltration soil media performed in accordance with ASTM D422, Standard Test Method for Particle Size Analysis of Soils.
 - A description of the equipment and methods used to mix the sand and compost to produce the biofiltration soil media.
- The name of the testing laboratory(ies) and the following information:

- Contact person(s)
- Address(es)
- Phone contact(s)
- E-mail address(es)
- Qualifications of laboratory(ies) and personnel including date of current certification by STA, ASTM, or approved equal.
- Biofiltration soils shall be analyzed by an accredited laboratory using #200 and ½-inch sieves (ASTM D422 or as approved by LACDPW), and meet the gradation described in the table below:

Particle Size (ASTM D422)	% Passing by Weight
½ inch	97-100
#200	2-5

- Biofiltration soil media shall be analyzed by an accredited geotechnical laboratory for the following tests:
 - Moisture – density relationships (compaction tests) must be conducted on biofiltration soil media. Biofiltration soil media for the permeability test shall be compacted to 85 to 90 percent of the maximum dry density (ASTM D1557).
 - Constant head permeability testing in accordance with ASTM D2434 shall be conducted on a minimum of two samples with a 6-inch mold and vacuum saturation.
- Mulch is recommended for the purpose of retaining moisture, preventing erosion, and minimizing weed growth. Projects subject to the California Model Water Efficiency Landscaping Ordinance (or comparable local ordinance) will be required to provide at least 2 inches of mulch. Aged mulch, also called compost mulch, reduces the ability of weeds to establish, keeps soil moist, and replenishes soil nutrients. Biofiltration areas must be covered with two to four inches (average three inches) of mulch at the start and an annual placement (preferably in June after weeding) of one to two inches of mulch beneath plants.
- The planting media design height must be marked appropriately, such as a collar on the overflow device or with a stake inserted two feet into the planting media and notched, to show biofiltration surface level and ponding level.

Vegetation

Prior to installation, a licensed landscape architect must certify that all plants, unless otherwise specifically permitted, conform to the standards of the current edition of American Standard for Nursery Stock as approved by the American Standards Institute, Inc. All plant grades shall be those established in the current edition of American Standards for Nursery Stock.

- Shade trees must have a single main trunk. Trunks must be free of branches below the following heights:

CALIPER (in)	Height (ft)
1½-2½	5
3	6

- Plants must be tolerant of summer drought, ponding fluctuations, and saturated soil conditions for 96 hours.
- It is recommended that a minimum of three types of tree, shrubs, and/or herbaceous groundcover species be incorporated to protect against facility failure due to disease and insect infestations of a single species.
- Native plant species and/or hardy cultivars that are not invasive and do not require chemical inputs must be used to the maximum extent practicable.

The biofiltration area should be vegetated to resemble a terrestrial forest community ecosystem, which is dominated by understory trees, a shrub layer, and herbaceous ground cover. Select vegetation that:

- Is suited to well-drained soil;
- Will be dense and strong enough to stay upright, even in flowing water;
- Has minimum need for fertilizers;
- Is not prone to pests and is consistent with Integrated Pest Management practices; and
- Is consistent with local water conservation ordinance requirements.

Irrigation System

Provide an irrigation system to maintain viability of vegetation, if applicable. The irrigation system must be designed to local code or ordinance specifications.

Restricted Construction Materials

The use of pressure-treated wood or galvanized metal at or around a biofiltration area is prohibited.

Overflow Device

An overflow device is required at the 18-inch ponding depth. The following, or equivalent, should be provided:

- A vertical PVC pipe (SDR 26) to act as an overflow riser.
- The overflow riser(s) should be eight inches or greater in diameter, so it can be cleaned without damage to the pipe.

- The inlet to the riser should be at the ponding depth (18 inches for fenced biofiltration areas and 6 inches for areas that are not fenced), and be capped with a spider cap to exclude floating mulch and debris. Spider caps should be screwed in or glued (e.g., not removable). The overflow device should convey stormwater runoff in excess of 1.5 times the SWQDv that is not reliably retained on the project site to an approved discharge location (another stormwater quality control measure, storm drain system, or receiving water).

Maintenance Requirements

Maintenance and regular inspections are important for proper function of biofiltration areas. Biofiltration areas require annual plant, soil, and mulch layer maintenance to ensure optimal infiltration, storage, and pollutant removal capabilities. In general, biofiltration maintenance requirements are typical landscape care procedures and include:

- Irrigate plants as needed during prolonged dry periods. In general, plants should be selected to be drought-tolerant and not require irrigation after establishment (two to three years).
- Inspect flow entrances, ponding area, and surface overflow areas periodically, and replace soil, plant material, and/or mulch layer in areas if erosion has occurred. Properly-designed facilities with appropriate flow velocities should not cause erosion except potentially during in extreme events. If erosion occurs, the flow velocities and gradients within the biofiltration area and flow dissipation and erosion protection strategies in the pretreatment area and flow entrance should be reassessed. If sediment is deposited in the biofiltration area, identify the source of the sediment within the tributary area, stabilize the source, and remove excess surface deposits.
- Prune and remove dead plant material as needed. Replace all dead plants, and if specific plants have a high mortality rate, assess the cause and, if necessary, replace with more appropriate species.
- Remove weeds as needed until plants are established. Weed removal should become less frequent if the appropriate plant species are used and planting density is attained.
- Select the proper soil mix and plants for optimal fertility, plant establishment, and growth to preclude the use of nutrient and pesticide supplements. By design, biofiltration facilities are located in areas where phosphorous and nitrogen levels are often elevated such that these should not be limiting nutrients. Addition of nutrients and pesticides may contribute pollutant loads to receiving waters.
- In areas where heavy metals deposition is likely (i.e., tributary areas to industrial, vehicle dealerships/repair, parking lots, roads), replace mulch annually. In areas where metals deposition is less likely (i.e., residential lots), replace or add mulch as needed to maintain a two to three inch depth at least once every two years.

- Analyze soil for fertility and pollutant levels if necessary. Biofiltration soil media are designed to maintain long-term fertility and pollutant processing capability.
- Eliminate standing water to prevent vector breeding.
- Inspect overflow devices for obstructions or debris, which should be removed immediately. Repair or replace damaged pipes upon discovery.
- Inspect, and clean if necessary, the underdrain.

A summary of potential problems that need to be addressed by maintenance activities is presented in Table E-13.

The County requires execution of a maintenance agreement to be recorded by the property owner for the on-going maintenance of any privately-maintained stormwater quality control measures. The property owner is responsible for compliance with the maintenance agreement. A sample maintenance agreement is presented in Appendix H.

Table E-13. Biofiltration Troubleshooting Summary

Problem	Conditions When Maintenance Is Needed	Maintenance Required
Vegetation	Overgrown vegetation	Mow and prune vegetation as appropriate.
	Presence of invasive, poisonous, nuisance, or noxious vegetation or weeds	Remove this vegetation and plant native species as needed.
Trash and Debris	Trash, plant litter, and dead leaves present	Remove and properly dispose of trash and debris.
Irrigation (if applicable)	Not functioning correctly	Check irrigation system for clogs or broken lines and repair as needed.
Inlet/Overflow	Inlet/overflow areas clogged with sediment and/or debris	Remove material.
	Overflow pipe blocked or broken	Repair as needed.
Erosion/Sediment Accumulation	Splash pads or spreader incorrectly placed Presence of erosion or sediment accumulation	Check inlet structure to ensure proper function. Repair, or replace if necessary, the inlet device. Repair eroded areas with gravel as needed. Re-grade the biofiltration area as needed.
Contaminants and Pollution	Any evidence of oil, gasoline, contaminants, or other pollutants	Remove any evidence of visual contamination from floatables such as oil and grease.
Standing water	Standing water observed more than 96 hours after storm event	Inspect, and clean as needed, the underdrain to ensure proper function. Clear clogs as needed. Remove and replace planter media (sand, gravel, topsoil, mulch) and vegetation.

VEG-1: Green Roof

Description

A green roof is a multi-layered system comprised of light-weight growth media and a specialized mix of vegetation underlain by a root barrier, a drainage layer, and a waterproofing membrane to protect the building structure. There are two types of green roofs: intensive and extensive. Intensive green roofs are characterized by thick soil depths, heavy weights, and elaborate plantings that include shrubs and trees.

Extensive green roofs consist of a thin soil layer and a cover of grass, sedums, or moss.



Green roofs reduce stormwater runoff volume and peak discharge flow rates by retaining precipitation within the pore space of the growing medium and slowly releasing the water via evaporation from soil and transpiration by plants. Green roofs improve stormwater runoff quality through biological, physical, and chemical processes that occur within the plants and growth media to prevent airborne pollutants from entering the storm drain system. A drain system and overflow to an approved conveyance and destination/disposal method is also required.

A schematic of a typical green roof is presented in Figure E-8.

LID Ordinance Requirements

Green roofs can be used as a stormwater quality control measure to treat stormwater runoff for the following alternative compliance measures:

- Off-site infiltration;
- Groundwater replenishment projects; and
- Off-site retrofit of existing development.

The project applicant must ensure that all pollutants of concern are addressed when using a green roof (see Section 7.4). If a green roof is to be used as an alternative compliance measure then the media must comply with the “Planting/Storage Media” requirements. If it will not be used as an alternative compliance measure then this section can be ignored.

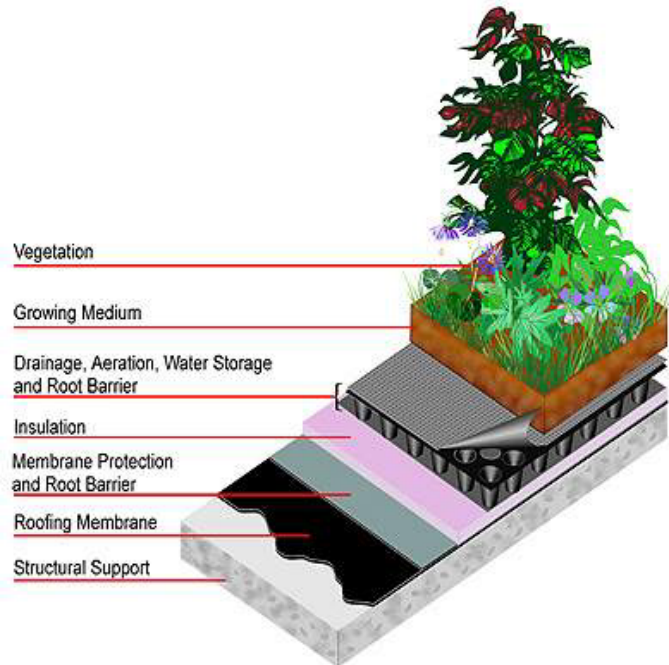

Source: American Wick

Figure E-8. Green Roof Schematic

Advantages

- Reduces size of downstream stormwater quality control measures
- Requires no additional space
- Provides thermal insulation, which reduces energy costs
- Extends roof life by protecting underlying roof material from climatic extremes, ultraviolet light, and damage
- Reduces amount of airborne pollutants entering the storm drain system.
- Reduces volume and peak flows of stormwater runoff
- Absorbs air pollution, collects airborne particulate matter, and negates acid rain effects
- Provides “islands” or “stepping stone” habitat for wildlife, particularly avian species
- Reduces urban heat island effect
- Provides sound insulation to reduce noise transfer (i.e., air traffic)

Disadvantages

- Are likely best incorporated into plans for new buildings that provide adequate structural support; however, can be retrofitted for existing buildings
- Increases building costs due to special structural design requirements

- Requires appropriate vegetation selection, maintenance, and irrigation because of the long, hot, and dry summer conditions in the Los Angeles County area

General Constraints and Implementation Considerations

- The climate, particularly temperature and rainfall patterns, must be considered.
- The size, slope, height, and directional orientation of the roof must be considered. Green roofs are typically installed on flat roofs, but may be installed on roofs with slopes up to 10 percent unless the project applicant can provide documentation for steeper slopes.
- The amount of stormwater runoff mitigated by a green roof is directly proportional to the area it covers, the depth and type of the growing medium, slope, and the type of plants selected.
- Green roofs must be designed to handle the green roof load, including during periods of saturation. Green roofs are appropriate for industrial and commercial facilities and large residential buildings (i.e., condominiums, apartment complexes). Green roofs may also be used for small residential buildings under some circumstances.
- Safe access must be available for workers and materials during both construction and maintenance. Residents should understand the maintenance requirements necessary to keep the green roof functional.
- Visibility, architectural fit, and aesthetic preferences should be identified.
- Green roofs should be evaluated for compatibility with other systems (i.e., solar panels).
- Irrigation systems are necessary to maintain viability of green roofs. The irrigation system for the green roof should be coordinated with the design of general irrigation system, as applicable.
- Vegetation should be selected, installed, and maintained by experienced horticulturists or landscaping contractors who understand the County's local environment and climate.
- Green roof components, particularly the vegetation, must be protected until established.
- Construction of the green roof in sections provides for easier inspection and maintenance access to the waterproofing membrane and roof drains.

Design Specifications

Proprietary green roof applications must comply with the vendor's design specifications for installation and maintenance. In the case of a conflict between vendor guidelines and County requirements, the more stringent standards shall apply. Design specifications for green roofs are listed in Table E-14. Other design specifications for green roofs are discussed in the sections below.

Table E-14. Green Roof Design Specifications for Extensive and Intensive Green Roofs

Design Parameter	Extensive Green Roof	Intensive Green Roof
Growth media	Typical depth: 2-6 inches Mix should have high mineral content	Typical depth: 8 inches Mix should have high mineral content
Load	10-30 psf	60 psf
Vegetation	Variety of vegetated ground cover and grasses. Select vegetation that is drought-tolerant and requires little maintenance	Large trees, shrubs, and complex gardens. Select vegetation that is drought-tolerant and requires little maintenance
Waterproofing membrane	Resistant to biological and root attack	Resistant to biological and root attack
Public access	Usually not designed for public access	Accommodated and encouraged
Maintenance	Annual maintenance walks should be performed until plants are established	Significant maintenance required
Drainage	Simple irrigation and drainage system	Complex irrigation and drainage system

Growth Media

For extensive green roofs, the growth medium is generally well-drained, 2 to 6 inches thick, and weighing 10 to 30 psf. For intensive green roofs, a minimum soil depth of 8 inches and weight of 60 psf should be used. A simple mix of 25 percent topsoil, 25 percent compost, and 50 percent pumice perlite may be sufficient for many applications. Some companies have their own growth medium specifications. Other components may include digested fiber, expanded clay or shale, or coir. Soil coverage to prevent erosion must be established immediately upon installation by using mulch, vegetation mats, or other approved protection method.

Vegetation

Green roof vegetation should have the following characteristics:

- Drought-tolerant, requiring little or no irrigation after establishment;
- A growth pattern that allows the plant to thoroughly cover the soil. At least 90 percent of the overall surface must be covered within two years of installation;
- Self-sustaining, without the need for fertilizers, pesticides, or herbicides;
- Able to withstand heat, cold, and high winds;
- Very low maintenance requirements (e.g., needing little/no mowing or trimming);
- Perennial or self-sowing; and

- Fire resistant.

A mix of sedum/succulent plant communities is recommended because they possess many of these attributes. Herbs, forbs, grasses, and other low ground covers can also be used to provide additional benefits and aesthetics; however, these plants may need more watering and maintenance to survive and maintain their appearance.

Waterproof Membrane

A good quality waterproofing material must be used on the roof surface. Waterproof membranes are made of various materials, such as modified asphalts (bitumens), synthetic rubber ethylene propylene diene monomer (EPDM), hypolan chlorosulfonated polyethylene (CSPE), and reinforced polyvinyl chloride (PVC). Waterproofing materials may come in sheets or rolls or in liquid form, and have different strengths and functional characteristics. Some waterproofing materials require root inhibitors and other materials to protect the membrane. Numerous companies manufacture waterproofing materials appropriate for green roofs.

Protection Boards or Materials

Protection boards or materials, which are typically made of soft fibrous materials, protect waterproofing membrane from damage during construction and over the life of the green roof.

Root Barrier

Root barriers are made of dense materials that inhibit root penetration. The need for a root barrier depends on the waterproofing membrane selected. Modified asphalts usually require a root barrier while EPDM and reinforced PVC generally do not. Check with the manufacturer to determine if a root barrier is required for a particular product. Membranes impregnated with pesticides are not allowed. Manufacturers must provide LACDPW with evidence that membranes impregnated with copper will not leach out at levels of concern.

Structural Roof Support

The structural roof support must be sufficient to hold the additional weight of the green roof, including during periods of saturation. For retrofit projects, check with an architect, structural engineer, or roof consultant to determine the condition of the existing building structure and what might be needed to support a green roof (i.e., additional decking, roof trusses, joists, columns, foundations). Generally, the building structure must be adequate to hold an additional 10 to 25 pounds psf saturated weight, depending on the vegetation and growth medium used. (This is in addition to snow load requirements.) An existing rock ballast roof may be structurally sufficient to hold a 10 to 12 psf green roof. (Ballast typically weighs 10 to 12 psf.)

For new development, the architects and structural engineers must address the structural requirements of the green roof during the design process. Greater flexibility

and options are available for new buildings than for retrofit. The procedures for the remaining components are the same for both reroofing and new construction.

Gravel Ballast

Gravel ballast is sometimes placed along the perimeter of the roof and at air vents or other vertical elements. The need for gravel ballast depends on operational and structural design issues. They are sometimes used to provide maintenance access, especially to vertical elements requiring periodic maintenance. In many cases very little, if any, ballast is needed. In some situations a header or separation board may be placed between the gravel ballast and adjacent elements (such as soil or drains). If a root barrier is used, it must extend under the gravel ballast and growth medium and up the side of the vertical elements.

Installation

Four methods (or combinations of them) are generally used to install the vegetation: vegetation mats, plugs/potted plants, sprigs, and seeds.

- Vegetation mats are sod-like, pre-germinated mats that achieve immediate full-plant coverage. They provide immediate erosion control, do not need mulch, and minimize weed intrusion. They also need minimal maintenance during the establishment period and little on-going watering and weeding.
- Plugs or potted plants may provide more design flexibility than mats. However, they take longer to achieve full coverage, are more prone to erosion, need more watering during establishment, and require mulching and more weeding.
- Sprigs are hand broadcast. They require more weeding, erosion control, and watering than vegetation mats.
- Seeds can be either hand broadcast or hydroseeded. Like sprigs, they require more weeding, erosion control, and watering than vegetation mats.

Drainage Layer

There are numerous ways to provide drainage. Products range from manufactured perforated plastic sheets to a thin layer of gravel. Some green roof designs do not require any drainage layer other than the growth medium itself, depending on roof slope and size (e.g., pitched and small flat roofs).

Drainage System

As with a conventional roof, a green roof must safely drain stormwater runoff from the roof to an approved location.

Irrigation System

Temporary irrigation to establish plants is recommended. A permanent irrigation system using potable water may be used, but an alternative means of irrigation such as air conditioning condensate or other non-potable sources is recommended.

Maintenance Requirements

Maintenance and regular inspections are important for proper function of green roofs. Once a properly installed green roof is established, its maintenance requirements are usually minimal. Intensive green roofs tend to have higher maintenance requirements compared to extensive green roofs due to its increased weight and more concentrated plantings. Written guidance and the operations and maintenance manual for the green roof should be provided to all new owners and tenants. The following are general maintenance requirements:

- Inspect waterproofing membrane two to three times per year including prior to winter and after periods of heavy stormwater runoff.
- Inspect soil for evidence of erosion from wind or water. If erosion channels are evident, stabilize them with additional soil substrate/growth medium and cover with additional plants.
- Operate and maintain structural components of the green roof according to manufacturer's requirements.
- Keep drain inlets unrestricted. Clear inlet pipe when soil substrate, vegetation, debris, or other materials clog the drain inlet. Identify and correct sources of sediment and debris. Determine if the drain inlet pipe is in good condition and correct as needed.
- Remove debris to prevent inlet drain clogging and interference with plant growth.
- Maintain vegetation to provide 90 percent plant cover. During the establishment period, replace plants once per month as needed. After the establishment period, replace dead plants as needed. Remove plant litter and nuisance and prohibited vegetation regularly. Remove weeds manually without herbicides or pesticides. Do not apply fertilizers. Mow grass as needed and remove clippings.
- During drought conditions, mulch or shade cloth may be applied to prevent excess solar damage and water loss.
- Irrigate green roof either through hand watering or automatic sprinkler systems. If automatic sprinklers are used, follow manufacturer's instructions for operations and maintenance. During the establishment period (one to three years), provide sufficient irrigation to assure plant establishment. Following the establishment period (after three years), provide sufficient irrigation to maintain plant cover.
- Exercise spill prevention measures from mechanical systems located on roofs when handling substances that can contaminate stormwater runoff.

- Provide training and/or written guidance information for operating and maintaining green roofs to all property owners and tenants. Provide a copy of the operations and maintenance plan to all property owners and tenants.
- Provide safe and efficient access to the green roof. Maintain egress and ingress routes to design specifications. Clear walkways of obstructions and maintain them to design specifications.
- Eliminate standing water to prevent vector breeding.

A summary of potential problems that may need to be addressed by maintenance activities is presented in Table E-15.

The County requires execution of a maintenance agreement to be recorded by the property owner for the on-going maintenance of any privately-maintained stormwater quality control measures. The property owner is responsible for compliance with the maintenance agreement. A sample maintenance agreement is presented in Appendix H.

Table E-15: Green Roof Troubleshooting Summary

Problem	Conditions When Maintenance Is Needed	Maintenance Required
Vegetation	Overgrown vegetation	Mow and trim as needed.
	Dead plants present	Remove dead plants and re-plant as needed.
	Presence of invasive, poisonous, nuisance, or noxious vegetation or weeds	Remove this vegetation.
Contaminants and Pollution	Any evidence of oil, gasoline, contaminants, or other pollutants	Remove any evidence of visual contamination.
Erosion/Sediment Accumulation	Undercut or eroded areas at inlet structures	Stabilize eroded areas with additional soil/growth medium and cover with additional plants.
	Accumulation of sediment, debris, and oil/grease on surface or inlet	Remove sediment, debris, and/or oil/grease.
Obstructions	Flow into green roof impeded	Remove obstruction.
Vector Breeding	Standing water	Remove standing water. Implement Integrated Pest Management.

VEG-2: Stormwater Planter

Description

A stormwater planter is a stormwater quality control measure that is completely contained within an impermeable structure with an underdrain. Stormwater planters function as a soil- and plant-based filtration device that remove pollutants through a variety of physical, biological, and chemical treatment processes. A stormwater planter consists of a ponding area, mulch layer, planting soils, plantings, and an underdrain within the planter box. As stormwater runoff passes through the planting soil, pollutants are filtered, adsorbed, and biodegraded by the soil and plants. Stormwater planters are typically planted with native, drought-tolerant vegetation that does not require fertilization and can withstand wet soils for at least 96 hours.



Stormwater planters may be placed adjacent to or near buildings, other structures, or sidewalks. Stormwater planters can be used directly adjacent to buildings beneath downspouts as long as the planters are properly lined on the building side and the overflow outlet discharges away from the building to ensure water does not percolate into footings or foundations. They can also be placed further away from buildings by conveying roof runoff in shallow engineered open conveyances, shallow pipes, or other innovative drainage structures.

A schematic of a typical stormwater planter is presented in Figure E-9.

LID Ordinance Requirements

Stormwater planters can be used as a stormwater quality control measure to treat stormwater runoff for the following alternative compliance measures:

- Off-site infiltration;
- Groundwater replenishment projects; and
- Off-site retrofit of existing development.

The project applicant must ensure that all pollutants of concern are addressed when using a stormwater planter (see Section 7.4). The following table identifies the pollutants of concern that are treated to the water quality benchmark (see Table 7-2 of the LID Standards Manual) by a stormwater planter:

Pollutant of Concern	Treated by Stormwater Planters?
Suspended solids	No
Total phosphorus	No
Total nitrogen	Yes
Total Kjeldahl nitrogen	Yes
Cadmium, total	No
Chromium, total	Yes
Copper, total	No
Lead, total	Yes
Zinc, total	No

Source: Treatment Best Management Practices Performance, Los Angeles Regional Water Quality Control Board, December 9, 2013.

Advantages

- Has a low cost when integrated into site landscaping
- Can be useful for disconnecting downspouts
- Requires little space
- Is suitable for parking lots and sites with limited open area available for stormwater runoff treatment
- Reduces peak flows during small storm events
- Enhances site aesthetics
- May conserve water
- Requires little maintenance

Disadvantages

- May not be appropriate for industrial sites or locations with contaminated soils or where spills may occur because of the potential threat to groundwater contamination
- Is not suitable for areas with steep slopes
- Requires irrigation, which may conflict with water conservation ordinances or landscape requirements, to maintain vegetation
- May result in potentially increased cost due to waterproofing exterior building walls, if needed

VEG-2: Stormwater Planter

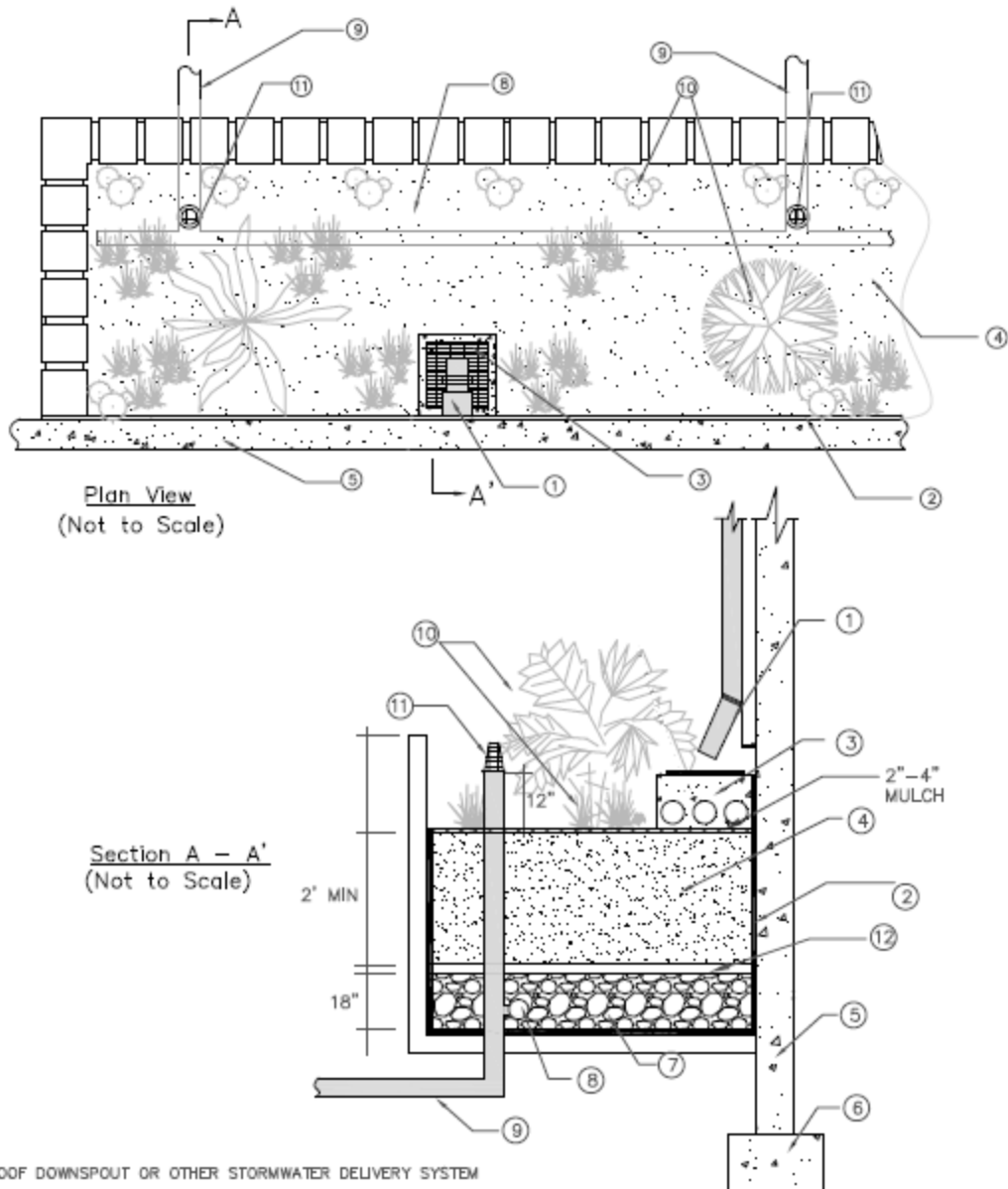

NOTES:

- ① ROOF DOWNSPOUT OR OTHER STORMWATER DELIVERY SYSTEM
- ② WATERPROOF BARRIER
- ③ SHALLOW ENERGY DISSIPATOR BASIN DISPERSES FLOW AT SOIL SURFACE
- ④ SOIL MIX (SEE PLANTING MEDIA SECTION)
- ⑤ BUILDING
- ⑥ FOUNDATION. INSTALL FOUNDATION DRAINS AS NEEDED
- ⑦ GRAVEL BEDDING (SEE UNDERDRAIN)
- ⑧ PERFORATED PIPE SHALL RUN ENTIRE LENGTH OF PLANTER
- ⑨ CONNECTION TO DOWNSTREAM CONVEYANCE SYSTEM
- ⑩ PLANTS
- ⑪ SET OVERFLOW 2" BELOW THE TOP OF THE PLANTER
- ⑫ OPTIONAL CHOKING GRAVEL LAYER

Figure E-9. Stormwater Planter Schematic

General Constraints and Implementation Considerations

- Stormwater planters are suitable for smaller tributary areas such as urban infill projects.
- Stormwater planters can be integrated into other landscaping areas.
- For stormwater planters next to buildings, waterproofing of exterior building walls must be provided as directed by an architect or structural engineer.
- The site topography must be relatively flat.
- During construction activities should avoid compaction of native soils below planting media layer or gravel zone.
- Stormwater runoff must be diverted around the stormwater planter during the period of vegetation establishment. If diversion is not feasible, the graded and seeded areas must be protected with suitable sediment controls (i.e., silt fences).
- All damaged areas should be repaired, seeded, or re-planted immediately.
- The general landscape irrigation system should incorporate the stormwater planter, as applicable.

Design Specifications

The following sections describe the design specifications for stormwater planters.

Geotechnical

Due to the potential to contaminate groundwater, cause slope instability, impact surrounding structures, and potential for insufficient infiltration capacity, an extensive geotechnical site investigation must be conducted during the site planning process to verify site suitability for a stormwater planter. All geotechnical investigations must be performed according to the most recent GMED Policy GS 200.1. Soil infiltration rates and the groundwater table depth must be evaluated to ensure that conditions are satisfactory for proper operation of a stormwater planter. The project applicant must demonstrate through infiltration testing, soil logs, and the written opinion of a licensed civil engineer that sufficiently permeable soils exist on-site to allow the construction of a properly functioning stormwater planter.

Geometry

- The minimum soil depth should be 12 to 18 inches. The minimum soil depth is required to provide a beneficial root zone for the chosen vegetation and adequate storage capacity for stormwater runoff. A deeper planting soil depth will provide a smaller surface area footprint.
- The minimum stormwater planter width is 30 inches.
- Any stormwater planter shape configuration is possible as long as the other design specifications are met.

- The distance between the downspouts and the overflow outlet should be maximized in order to increase the opportunity for stormwater runoff retention and filtration.

Sizing

Stormwater planters are sized using a simple sizing method where the SWQDv must be completely filtered within 96 hours. If the incoming stormwater runoff flow rate is lower than the long term filtration rate, above ground storage does not need to be provided. If the incoming stormwater runoff flow rate is higher than the long term filtration rate, above ground storage shall be provided (see steps below).

Step 1: Calculate the design volume

Stormwater planters areas should be sized to capture and treat the SWQDv (see Section 6 for SWQDv calculation procedures) that is not reliability retained on the project site, as calculated by the equation below:

$$V_{SP} = SWQDv - V_r$$

Where:

V_{SP} = Biofiltration volume [ft³];
 $SWQDv$ = Stormwater quality design volume [ft³]; and
 V_r = Volume of stormwater runoff reliably retained on-site [ft³].

Step 2: Calculate the design infiltration rate

Determine the corrected in-situ infiltration rate (f_{design}) of the native soil using the procedures described in the most recent GMED Policy GS 200.1.

Step 3: Calculate the surface area

Select a surface ponding depth (d) that satisfies the geometric criteria and meets the site constraints. Selecting a deeper ponding depth (up to 1.5 ft) generally yields a smaller footprint, however, it will require greater consideration for public safety, energy dissipation, and plant selection.

Calculate the time for the selected ponding depth to filter through the planting media using the following equation:

$$t_p = \frac{d}{\left(\frac{f_{design}}{12}\right)}$$

Where:

t_p = Required detention time for surface ponding (max 96 hr) [hr];
 d = Ponding depth (max 1.5 ft) [ft]; and
 f_{design} = Design infiltration rate [in/hr].

If t_p exceeds 96 hours, reduce surface ponding depth (d). In nearly all cases, t_p should not approach 96 hours unless f_{design} is low.

Calculate the required infiltrating surface (filter bottom area) using the following equation:

$$A = \frac{V_B}{d}$$

Where:

A = Bottom surface area of biofiltration area [ft²];
 V_B = Biofiltration design volume [ft³]; and
 d = Ponding depth (max 1.5 ft) [ft].

Flow Entrance and Energy Dissipation

The following types of flow entrance can be used for stormwater planters:

- Piped entrances, such as roof downspouts, should include rock, splash blocks, or other erosion controls at the entrance to dissipate energy and disperse flows.
- Woody plants (trees, shrubs, etc.) can restrict or concentrate flows and can be damaged by erosion around the root ball and must not be placed directly in the entrance flow path.

Drainage

Stormwater planters must be designed to drain below the planting soil depth in less than 96 hours. Soils must be allowed to dry out periodically in order to restore hydraulic capacity to receive stormwater runoff from subsequent storm events, maintain infiltration rates, maintain adequate soil oxygen levels for healthy soil biota and vegetation, and provide proper soil conditions for biodegradation and retention of pollutants.

Underdrain

Stormwater planters require an underdrain to collect and discharge stormwater runoff that has been filtered through the soil media, but not infiltrated, to another stormwater quality control measure, storm drain system, or receiving water. The underdrain shall have a mainline diameter of eight inches using slotted PVC SDR 26 or PVC C9000. Slotted PVC allows for pressure water cleaning and root cutting, if necessary. The slotted pipe should have two to four rows of slots cut perpendicular to the axis of the pipe or at right angles to the pitch of corrugations. Slots should be 0.04 to 0.1 inches

wide with a length of 1 to 1.25 inches. Slots should be longitudinally-spaced such that the pipe has a minimum of one square inch opening per lineal foot and should face down.

The underdrain should be placed in a gravel envelope (Class 2 Permeable Material per Caltrans Spec. 68-1.025) that measures three feet wide and six inches deep. The underdrain is elevated from the bottom of the stormwater planter by six inches within the gravel envelope to create a fluctuating anaerobic/aerobic zone below the underdrain to facilitate denitrification within the anaerobic/anoxic zone and reduce nutrient concentrations. The top and sides of the underdrain pipe should be covered with gravel to a minimum depth of 12 inches. The underdrain and gravel envelope should be covered with a geomembrane liner to prevent clogging. The following aggregate should be used for the gravel envelope:

Particle Size (ASTM D422)	% Passing by Weight
¾ inch	100%
¼ inch	30-60%
#8	20-50%
#50	3-12%
#200	0-1%

Underdrains should be sloped at a minimum of 0.5 percent, and must drain freely to an acceptable discharge point.

Rigid non-perforated observation pipes with a diameter equal to the underdrain diameter should be connected to the underdrain to provide a clean-out port as well as an observation well to monitor drainage rates. The wells/clean-outs should be connected to the perforated underdrain with the appropriate manufactured connections. The wells/clean-outs should extend six inches above the top elevation of the stormwater planter mulch, and should be capped with a lockable screw cap. The ends of underdrain pipes not terminating in an observation well/clean-out should also be capped.

Hydraulic Restriction Layer

A geomembrane liner may be placed between the planting media and the drain rock. If a geomembrane liner is used, it should meet a minimum permittivity rate of 75 gal/min/ft² and should not impede the infiltration rate of the soil media. The geomembrane liner must meet the minimum requirements presented in Table E-16.

Table E-16 Geomembrane Liner Specifications for Stormwater Planters

Parameter	Test Method	Specification
Trapezoidal Tear	ASTM D4533	40 lbs (minimum)
Permeability	ASTM D4491	0.2 cm/sec (minimum)
AOS (sieve size)	ASTM D4751	#60 – #70 (minimum)
Ultraviolet Resistance	ASTM D4355	>70%

Preferably, aggregate should be used in place of a geomembrane layer to reduce the potential for clogging. This aggregate layer should consist of two to four inches of washed sand underlain with two inches of choking stone (typically #8 or #89 washed).

Vegetation

Prior to installation, a licensed landscape architect must certify that all plants, unless otherwise specifically permitted, conform to the standards of the current edition of American Standard for Nursery Stock as approved by the American Standards Institute, Inc. All plant grades shall be those established in the current edition of American Standards for Nursery Stock.

- Shade trees must have a single main trunk. Trunks must be free of branches below the following heights:

CALIPER (in)	Height (ft)
1½-2½	5
3	6

- Plants must be tolerant of summer drought, ponding fluctuations, and saturated soil conditions for up to 96 hours.
- It is recommended that a minimum of three types of tree, shrubs, and/or herbaceous groundcover species be incorporated to protect against facility failure due to disease and insect infestations of a single species.
- Native plant species and/or hardy cultivars that are not invasive and do not require chemical inputs must be used to the maximum extent practicable.

The stormwater planter should be vegetated to resemble a terrestrial forest community ecosystem, which is dominated by understory trees, a shrub layer, and herbaceous ground cover. Stormwater planters should be planted to cover at least 50 percent of the planter surface. Select vegetation that:

- Is suited to well-drained soil;
- Will be dense and strong enough to stay upright, even in flowing water;
- Has minimum need for fertilizers;

- Is not prone to pests and is consistent with Integrated Pest Management practices; and
- Is consistent with local water conservation ordinance requirements.

Irrigation System

Provide an irrigation system to maintain viability of vegetation, if applicable. The irrigation system must be designed to local code or ordinance specifications.

Planter Walls

Planter walls must be made of stone, concrete, brick, clay, plastic, wood, or other stable, permanent material. The use of pressure-treated wood or galvanized metal at or around a stormwater planter is prohibited.

Overflow Device

An overflow device is required at the 18-inch ponding depth. The following, or equivalent, should be provided:

- A vertical PVC pipe (SDR 26) to act as an overflow riser.
- The overflow riser(s) should be eight inches or greater in diameter, so it can be cleaned without damage to the pipe.
- The inlet to the riser should be a maximum of 18 inches above the planting soil, and be capped with a spider cap to exclude floating mulch and debris. Spider caps should be screwed in or glued (e.g., not removable). The overflow device should convey stormwater runoff in excess of the SWQDv to an approved discharge location (another stormwater quality control measure, storm drain system, or receiving water).

Maintenance Requirements

Maintenance and regular inspections are important for proper function of stormwater planters. Stormwater planters require annual plant, soil, and mulch layer maintenance to ensure optimal infiltration, storage, and pollutant removal capabilities. In general, stormwater planter maintenance requirements are typical landscape care procedures and include:

- Irrigate plants as needed during prolonged dry periods. In general, plants should be selected to be drought-tolerant and not require irrigation after establishment (two to three years).
- Inspect flow entrances, ponding area, and surface overflow areas periodically, and replace soil, plant material, and/or mulch layer in areas if erosion has occurred. Properly-designed facilities with appropriate flow velocities should not cause erosion except potentially during in extreme events. If erosion occurs, the flow velocities and gradients within the stormwater planter and flow dissipation

and erosion protection strategies in the flow entrance should be reassessed. If sediment is deposited in the stormwater planter, identify the source of the sediment within the tributary area, stabilize the source, and remove excess surface deposits.

- Prune and remove dead plant material as needed. Replace all dead plants, and if specific plants have a high mortality rate, assess the cause and, if necessary, replace with more appropriate species.
- Remove weeds as needed until plants are established. Weed removal should become less frequent if the appropriate plant species are used and planting density is attained.
- Select the proper soil mix and plants for optimal fertility, plant establishment, and growth to preclude the use of nutrient and pesticide supplements. By design, stormwater planters are located in areas where phosphorous and nitrogen levels are often elevated such that these should not be limiting nutrients. Addition of nutrients and pesticides may contribute pollutant loads to receiving waters.
- Analyze soil for fertility and pollutant levels if necessary. Stormwater planter soil media are designed to maintain long-term fertility and pollutant processing capability.
- Excavate and clean the stormwater planter if it does not drain within 96 hours after a storm event. Replace stormwater planter soil media as needed to improve the infiltration rate.
- Eliminate standing water to prevent vector breeding.
- Inspect, and clean if necessary, the underdrain.
- Inspect overflow devices for obstructions or debris, which should be removed immediately. Repair or replace damaged pipes upon discovery.
- Repair structural deficiencies to the stormwater planter including rot, cracks, and failure.
- Implement Integrated Pest Management practices if pests are present in the stormwater planter.
- Provide training and/or written guidance to all property owners and tenants. Provide a copy of the Maintenance Plan to all property owners and tenants.

A summary of potential problems that may need to be addressed by maintenance activities is presented in Table E-17.

The County requires execution of a maintenance agreement to be recorded by the property owner for the on-going maintenance of any privately-maintained stormwater quality control measures. The property owner is responsible for compliance with the maintenance agreement. A sample maintenance agreement is presented in Appendix H.

VEG-2: Stormwater Planter

Table E-17. Stormwater Planter Troubleshooting Summary

Problem	Conditions When Maintenance Is Needed	Maintenance Required
Vegetation	Overgrown vegetation	Mow and prune vegetation as appropriate.
	Presence of invasive, poisonous, nuisance, or noxious vegetation or weeds	Remove this vegetation and plant native species as needed.
Trash and Debris	Trash, plant litter, and dead leaves present	Remove and properly dispose of trash and debris.
Irrigation (if applicable)	Not functioning correctly	Check irrigation system for clogs or broken lines and repair as needed.
Inlet/Overflow	Inlet/overflow areas clogged with sediment and/or debris	Remove material. Ensure the downspout is clear of debris.
	Overflow pipe blocked or broken	Repair as needed.
Erosion/Sediment Accumulation	Splash pads or spreader incorrectly placed Presence of erosion or sediment accumulation	Check inlet structure to ensure proper function. Repair, or replace if necessary, the inlet device. Repair eroded areas with gravel as needed. Re-grade the stormwater planter as needed.
Contaminants and Pollution	Any evidence of oil, gasoline, contaminants, or other pollutants	Remove any evidence of visual contamination from floatables such as oil and grease.
Standing water	Standing water observed more than 96 hours after storm event	Inspect, and clean as needed, the underdrain to ensure proper function. Clear clogs as needed. Remove and replace planter media (sand, gravel, topsoil, mulch) and vegetation.

VEG-3: Tree-Well Filter

Description

A tree-well filter is similar to a biofiltration area and stormwater planters and consists of one or multiple chambered pre-cast concrete boxes with a small tree or shrub planted in a bed filled with soil media. Tree-well filters are typically installed along the edge of a parking lot or roadway, where a street tree might normally be planted, and is designed to receive, retain, and infiltrate stormwater runoff from adjoining paved areas. During storm events, stormwater runoff enters the chamber and gradually infiltrates and filters through the soil media into the underlying soil, or collected by an underdrain system.

Treatment occurs through a variety of natural mechanisms as the stormwater runoff filters through the root zone of the vegetation and during detention of the stormwater runoff in the pore space of the soil media. A portion of stormwater runoff held in the root zone of the soil media is returned to the atmosphere through transpiration by the vegetation. Stormwater runoff that reaches the bottom of the tree-well filter and does not infiltrate into underlying soils is collected and discharged through an underdrain.

A schematic of a typical tree-well filter is presented in Figure E-10.

LID Ordinance Requirements

Tree-well filters can be used as a stormwater quality control measure to treat stormwater runoff for the following alternative compliance measures:

- Off-site infiltration;
- Groundwater replenishment projects; and
- Off-site retrofit of existing development.

The project applicant must ensure that all pollutants of concern are addressed when using a tree-well filter (see Section 7.4). The following table identifies the pollutants of concern that are treated to the water quality benchmark (see Table 7-2 of the LID Standards Manual) by tree-well filter:



Source: Low Impact Development Center (top) and University of New Hampshire Stormwater Center (bottom)

Pollutant of Concern	Treated by Tree-Well Filter?
Suspended solids	No
Total phosphorus	No
Total nitrogen	Yes
Total Kjeldahl nitrogen	Yes
Cadmium, total	No
Chromium, total	Yes
Copper, total	No
Lead, total	Yes
Zinc, total	No

Source: Treatment Best Management Practices Performance, Los Angeles Regional Water Quality Control Board, December 9, 2013.

Advantages

- Enhances site aesthetics
- Integrates well with street landscapes
- Takes up very little space and may be ideal for highly-developed sites
- May be used in variety of site conditions
- Reduces stormwater runoff volume and pollutant discharge

Disadvantages

- May not be appropriate for industrial sites or locations with contaminated soils or where spills may occur because of the potential threat to groundwater contamination
- May require individual owners/tenants to perform maintenance
- Requires irrigation, which may conflict with water conservation ordinances for landscape requirements, to maintain vegetation

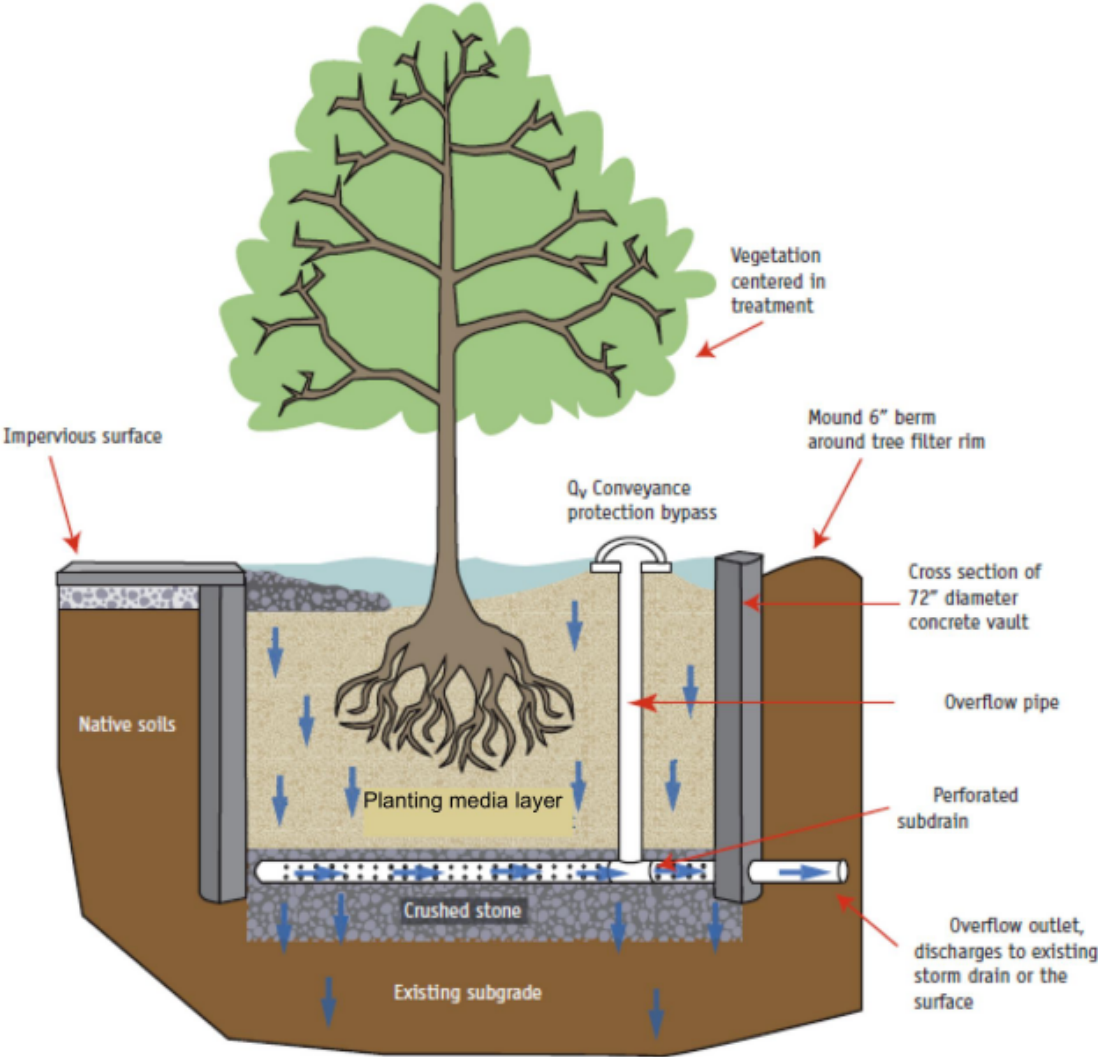

Figure E-10. Tree-Well Filter Schematic

General Constraints and Implementation Considerations

- Tree-well filters are ideally suited for small areas such as parking lot islands, perimeter building planters, street medians, roadside swale features, and site entrance or buffer features.
- Tree-well filters can be integrated into other landscape areas. Tree-well filters can have a non-rectangular footprint to fit site landscape design.
- Tree-well filters should be placed where site topography is relatively flat to allow stormwater runoff to drain to it.
- Stormwater runoff must be diverted around the tree-well filter during the period of vegetation establishment. If diversion is not feasible, the graded and seeded areas should be protected with suitable erosion controls (i.e., silt fences).
- Areas to be used for tree-well filters should be clearly marked before site work begins to avoid soil disturbance and compaction during construction. No vehicular traffic, except that specifically used to construct the tree-well filter, should be allowed within ten feet of the tree-well filter areas.
- Repair, seed, or re-plant damaged areas immediately.
- The general landscape irrigation system should incorporate the tree-well filter, as applicable.

Design Specifications

The following sections describe the design specifications for tree-well filters.

Geotechnical

Due to the potential to contaminate groundwater, cause slope instability, and impact surrounding structures, and potential for insufficient infiltration capacity, an extensive geotechnical site investigation must be conducted during the site planning process to verify site suitability for a tree-well filter. All geotechnical investigations must be performed according to the most recent GMED Policy GS 200.1. Soil infiltration rates and the groundwater table depth must be evaluated to ensure that conditions are satisfactory for proper operation of a tree-well filter. The project applicant must demonstrate through infiltration testing, soil logs, and the written opinion of a licensed civil engineer that sufficiently permeable soils exist on-site to allow the construction of a properly functioning tree-well filter.

Tree-well filters are appropriate for soils with a minimum corrected in-situ infiltration rate of 0.3 in/hr. The geotechnical report must determine if the proposed project site is suitable for a tree-well filter and must recommend a design infiltration rate (see “Design Infiltration Rate” under the “Sizing” section). The geotechnical investigation should be such that a good understanding is gained as to how the stormwater runoff will move through the soil (horizontally or vertically) and if there are any geological conditions that could inhibit the movement of water.

Sizing

Tree-well filters are sized using a simple sizing method where the SWQDv must be completely filtered within 96 hours. If the incoming stormwater runoff flow rate is lower than the long term filtration rate, above ground storage does not need to be provided. If the incoming stormwater runoff flow rate is higher than the long term filtration rate, above ground storage shall be provided (see steps below).

Step 1: Calculate the design volume

Tree-well filter areas should be sized to capture and treat the SWQDv (see Section 6 for SWQDv calculation procedures) that is not reliability retained on the project site, as calculated by the equation below:

$$V_{SP} = SWQDv - V_R$$

Where:

- V_{SP} = Biofiltration volume [ft³];
- SWQDv = Stormwater quality design volume [ft³]; and
- V_R = Volume of stormwater runoff reliably retained on-site [ft³].

Step 2: Calculate the design infiltration rate

Determine the corrected in-situ infiltration rate (f_{design}) of the native soil using the procedures described in the most recent GMED Policy GS 200.1.

Step 3: Calculate the surface area

Select a surface ponding depth (d) that satisfies the geometric criteria and meets the site constraints. Selecting a deeper ponding depth (up to 1.5 ft) generally yields a smaller footprint, however, it will require greater consideration for public safety, energy dissipation, and plant selection.

Calculate the time for the selected ponding depth to filter through the planting media using the following equation:

$$t_p = \frac{d}{\left(\frac{f_{design}}{12}\right)}$$

Where:

- t_p = Required detention time for surface ponding (max 96 hr) [hr];
- d = Ponding depth (max 1.5 ft) [ft]; and
- f_{design} = Design infiltration rate [in/hr].

If t_p exceeds 96 hours, reduce surface ponding depth (d). In nearly all cases, t_p should not approach 96 hours unless f_{design} is low.

Calculate the required infiltrating surface (filter bottom area) using the following equation:

$$A = \frac{V_B}{d}$$

Where:

A = Bottom surface area of biofiltration area [ft²];

V_B = Biofiltration design volume [ft³]; and

d = Ponding depth (max 1.5 ft) [ft].

Tree-well filters must be sized to capture and treat the SDWQv at a 18-inch maximum ponding depth acre.

The required surface area for the tree-well filter is determined from the SWQDv and ponding depth as follows:

$$A_s = \frac{SWQDv}{D_{pz}}$$

Where:

A_s = Surface area of tree-well filter [ft²];

SWQDv = Stormwater quality design volume [ft³]; and

D_{pz} = Average ponding depth (max 1.5 ft) [ft].

Flow Entrance and Energy Dissipation

The following types of flow entrance can be used for tree-well filters:

- Level spreaders (i.e., slotted curbs) can be used to facilitate sheet flow.
- Dispersed flow across pavement or gravel and past wheel stops for parking areas.
- Piped entrances, such as roof downspouts, should include rock, splash blocks, or other erosion controls at the entrance to dissipate energy and disperse flows.
- Curb cuts for roadside or parking lot areas, if approved by LACDPW: curb cuts should include rock or other erosion controls in the channel entrance to dissipate energy. Flow entrance should drop two to three inches from curb line and provide an area for settling and periodic removal of sediment and coarse material before flow dissipates to the remainder of the tree-well filter.

Drainage

Tree-well filters must be designed to drain below the planting soil depth in less than 96 hours. Soils must be allowed to dry out periodically in order to restore hydraulic capacity to receive stormwater runoff from subsequent storm events, maintain infiltration rates, maintain adequate soil oxygen levels for healthy soil biota and vegetation, and provide proper soil conditions for biodegradation and retention of pollutants.

Underdrain

Tree-well filters require an underdrain to collect and discharge stormwater runoff that has been filtered through the soil media, but not infiltrated, to another stormwater quality control measure, storm drain system, or receiving water. The underdrain shall have a mainline diameter of eight inches using slotted PVC SDR 26 or PVC C9000. Slotted PVC allows for pressure water cleaning and root cutting, if necessary. The slotted pipe should have two to four rows of slots cut perpendicular to the axis of the pipe or at right angles to the pitch of corrugations. Slots should be 0.04 to 0.1 inches wide with a length of 1 to 1.25 inches. Slots should be longitudinally-spaced such that the pipe has a minimum of one square inch opening per lineal foot and should face down.

The underdrain should be placed in a gravel envelope (Class 2 Permeable Material per Caltrans Spec. 68-1.025) that measures three feet wide and six inches deep. The underdrain is elevated from the bottom of the tree-well filter by six inches within the gravel envelope to create a fluctuating anaerobic/aerobic zone below the underdrain to facilitate denitrification within the anaerobic/anoxic zone and reduce nutrient concentrations. The top and sides of the underdrain pipe should be covered with gravel to a minimum depth of 12 inches. The underdrain and gravel envelope should be covered with a geomembrane liner to prevent clogging. The following aggregate should be used for the gravel envelope:

Particle Size (ASTM D422)	% Passing by Weight
¾ inch	100%
¼ inch	30-60%
#8	20-50%
#50	3-12%
#200	0-1%

Underdrains should be sloped at a minimum of 0.5 percent, and must drain freely to an acceptable discharge point.

Rigid non-perforated observation pipes with a diameter equal to the underdrain diameter should be connected to the underdrain to provide a clean-out port as well as an observation well to monitor drainage rates. The wells/clean-outs should be connected to the perforated underdrain with the appropriate manufactured connections. The wells/clean-outs should extend six inches above the top elevation of the tree-well

filter mulch, and should be capped with a lockable screw cap. The ends of underdrain pipes not terminating in an observation well/clean-out should also be capped.

Hydraulic Restriction Layer

A geomembrane liner may be placed between the planting media and the drain rock. If a geomembrane liner is used, it should meet a minimum permittivity rate of 75 gal/min/ft², should not impede the infiltration rate of the soil medium. The geomembrane liner must meet the minimum requirements presented in Table E-18.

Table E-18. Geomembrane Liner Specifications for Tree-Well Filters

Parameter	Test Method	Specification
Trapezoidal Tear	ASTM D4533	40 lbs (minimum)
Permeability	ASTM D4491	0.2 cm/sec (minimum)
AOS (sieve size)	ASTM D4751	#60 – #70 (minimum)
Ultraviolet Resistance	ASTM D4355	>70%

Preferably, aggregate should be used in place of a geomembrane layer to reduce the potential for clogging. This aggregate layer should consist of two to four inches of washed sand underlain with two inches of choking stone (typically #8 or #89 washed).

Vegetation

Select a tree that:

- Is suited to well-drained soil;
- Will be dense and strong enough to stay upright, even in flowing water;
- Has minimum need for fertilizers;
- Is not prone to pests and is consistent with Integrated Pest Management practices;
- Will withstand being inundated for periods of time; and
- Is consistent with local water conservation ordinance requirements.

Irrigation System

Provide an irrigation system to maintain viability of vegetation, if applicable. The irrigation system must be designed to local code or ordinance specifications.

Overflow Device

An overflow device is required at the 18-inch ponding depth. The following, or equivalent, should be provided:

- A vertical PVC pipe (SDR 26) to act as an overflow riser.

- The overflow riser(s) should be eight inches or greater in diameter, so it can be cleaned without damage to the pipe.
- The inlet to the riser should be a maximum of 18 inches above the planting soil, and be capped with a spider cap to exclude floating mulch and debris. Spider caps should be screwed in or glued (e.g., not removable). The overflow device should convey stormwater runoff in excess of the SWQDv to an approved discharge location (another stormwater quality control measure, storm drain system, or receiving water).

Maintenance Requirements

Maintenance and regular inspections are important for proper function of tree-well filters. Tree-well filters require annual plant, soil, and mulch layer maintenance to ensure optimal infiltration, storage, and pollutant removal capabilities. In general, tree-well filter maintenance requirements are typical landscape care procedures and include:

- Irrigate tree as needed. In general, trees should be selected to be drought-tolerant.
- Inspect flow entrances, ponding area, and surface overflow areas periodically, and replace soil, plant material, and/or mulch layer in areas if erosion has occurred. Properly designed facilities with appropriate flow velocities should not cause erosion except potentially during in extreme events. If erosion occurs, the flow velocities and gradients within the tree-well filter and flow dissipation and erosion protection strategies in the flow entrance should be reassessed. If sediment is deposited in the tree-well filter, identify the source of the sediment within the tributary area, stabilize the source, and remove excess surface deposits.
- Prune the tree as needed.
- Remove weeds in the tree-well filter.
- Select the proper soil mix and plants for optimal fertility, tree establishment, and growth to preclude the use of nutrient and pesticide supplements. By design, tree-well filters are located in areas where phosphorous and nitrogen levels are often elevated such that these should not be limiting nutrients. Addition of nutrients and pesticides may contribute pollutant loads to receiving waters.
- Analyze soil for fertility and pollutant levels if necessary. Soil mixes for tree-well filters are designed to maintain long-term fertility and pollutant processing capability.
- Excavate and clean the tree-well filter if it does not drain within 96 hours after a storm event. Replace tree-well filter soil media as needed to improve the infiltration rate.
- Eliminate standing water to prevent vector breeding.
- Inspect, and clean if necessary, the underdrain.

- Inspect overflow devices for obstructions or debris, which should be removed immediately. Repair or replace damaged pipes upon discovery.
- Repair structural deficiencies to the tree-well filter including rot, cracks, and failure.
- Implement Integrated Pest Management practices if pests are present in the tree-well filter.

A summary of potential problems that may need to be addressed by maintenance activities is presented in Table E-19.

The County requires execution of a maintenance agreement to be recorded by the property owner for the on-going maintenance of any privately-maintained stormwater quality control measures. The property owner is responsible for compliance with the maintenance agreement. A sample maintenance agreement is presented in Appendix H.

Table E-19. Tree-Well Filter Troubleshooting Summary

Problem	Conditions When Maintenance Is Needed	Maintenance Required
Vegetation	Overgrown vegetation	Mow and prune vegetation as appropriate.
	Presence of invasive, poisonous, nuisance, or noxious vegetation or weeds	Remove this vegetation and plant native species as needed.
Trash and Debris	Trash, plant litter, and dead leaves present	Remove and properly dispose of trash and debris.
Irrigation (if applicable)	Not functioning correctly	Check irrigation system for clogs or broken lines and repair as needed.
Inlet/Overflow	Inlet/overflow areas clogged with sediment and/or debris	Remove material. Ensure the downspout is clear of debris.
	Overflow pipe blocked or broken	Repair as needed.
Erosion/Sediment Accumulation	Inlet structure incorrectly placed Presence of erosion or sediment accumulation	Check inlet structure to ensure proper function. Repair, or replace if necessary, the inlet device. Repair eroded areas with gravel as needed. Re-grade the tree-well filter as needed.
Contaminants and Pollution	Any evidence of oil, gasoline, contaminants, or other pollutants	Remove any evidence of visual contamination from floatables such as oil and grease.
Standing water	Standing water observed more than 96 hours after storm event	Inspect, and clean as needed, the underdrain to ensure proper function. Clear clogs as needed. Remove and replace tree-well filter media (sand, gravel, topsoil, mulch) and vegetation.

VEG-4: Vegetated Swales



Description

Vegetated swales are open, shallow channels with low-lying vegetation covering the side slopes and bottom that collect and slowly convey stormwater runoff to a downstream stormwater quality control measure, storm drain system, or receiving water. Vegetated swales also provide pollutant removal through settling and filtration in the vegetation (usually grasses) lining the channels, provide the opportunity for stormwater runoff volume reduction through infiltration and evapotranspiration, and reduce the flow velocity.

An effective vegetated swale achieves uniform sheet flow over and through a densely vegetated area for a period of several minutes. Vegetated swales that are integrated into a project may use turf or other more intensive landscaping while swales that are located on the project perimeter, within a park, or close to an open space area may be planted with native plants. Vegetated swales are typically used to provide pretreatment prior to bioretention, infiltration, and biofiltration devices.

A schematic of a typical vegetated swale is presented in Figure E-11.

LID Ordinance Requirements

Vegetated swales can be used as a stormwater quality control measure to treat stormwater runoff for the following alternative compliance measures:

- Off-site infiltration;
- Groundwater replenishment projects; and
- Off-site retrofit of existing development.

The project applicant must ensure that all pollutants of concern are addressed when using a vegetated swale (see Section 7.4). According to the Los Angeles Regional Water Quality Control Board (Regional Water Board) *Treatment Best Management Practices Performance*, vegetated swales do not treat pollutants of concern to the water quality benchmark (see Table 7-2 of the LID Standards Manual).

Advantages

- Has a low cost for installation when integrated into site landscaping

- Is suitable for parking lots and sites with limited open area available for stormwater runoff retention
- Reduces peak stormwater runoff flows during small storm events
- Enhances site aesthetics
- Requires little maintenance

Disadvantages

- May not be appropriate for industrial sites or locations with contaminated soils or where spills may occur because of the potential threat to groundwater contamination
- Is not suitable for areas with steep slopes
- May be restricted in use for areas that require curb and gutter systems
- May not be effective and may even erode when flow velocities are high if the grass cover is not properly maintained
- May be difficult to avoid channelization
- Requires irrigation, which may conflict with water conservation ordinances for landscape requirements, to maintain vegetation

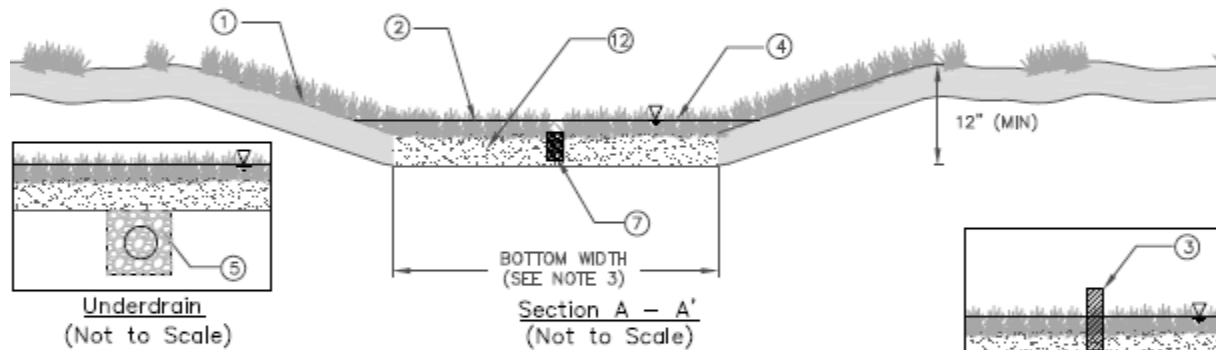
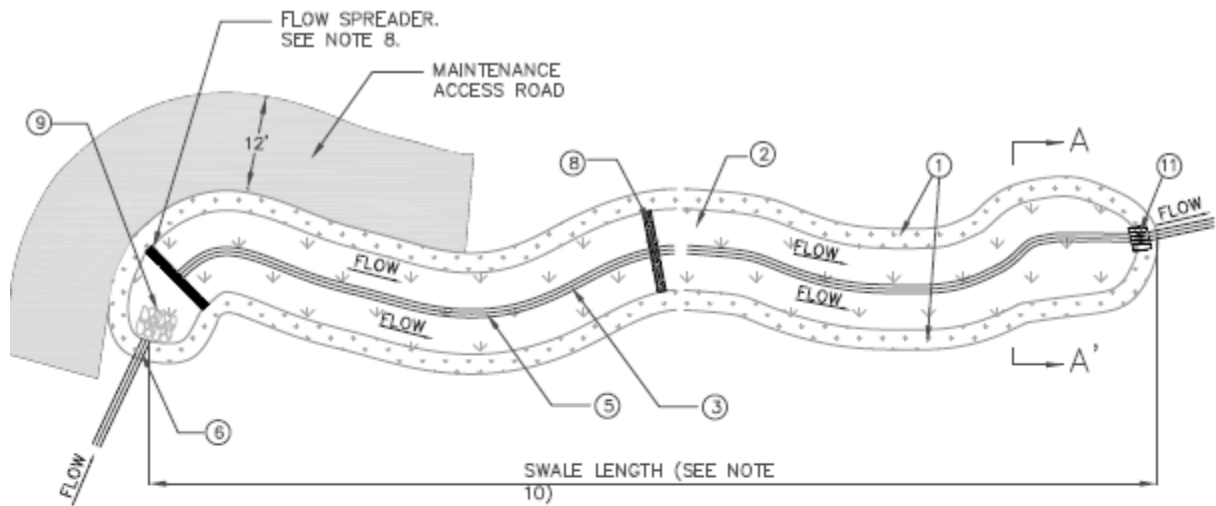

NOTES:

- ① VEGETATED SIDE SLOPES AT 2H:1V MAXIMUM SLOPE. MOWED TURF SWALES AT 3H:1V MAXIMUM.
- ② GRASS HEIGHT SHALL BE 4" - 6" HIGH.
- ③ SWALE DIVIDER REQUIRED FOR BOTTOM WIDTHS > 10'. MINIMUM REQUIRED BOTTOM WIDTH IS 2' EXCLUDING WIDTH OF LOW FLOW CHANNEL. MAXIMUM BOTTOM WIDTH WITH DIVIDER IS 16'.
- ④ DEPTH OF FLOW FOR WATER QUALITY TREATMENT MUST NOT EXCEED TWO-THIRDS OF THE GRASS HEIGHT AND NOT GREATER THAN 4" (INFREQUENTLY MOWED) OR 2" (FREQUENTLY MOWED).
- ⑤ 6" PERFORATED UNDERDRAIN IN 9" DEEP COARSE AGGREGATE BED CONNECTED TO STORM DRAIN. REQUIRED FOR SLOPES < 1.5% OR AS NEEDED.
- ⑥ INLET PIPE WITH INLET PROTECTION.
- ⑦ IF NO UNDERDRAIN, LOW FLOW DRAIN SHALL EXTEND ENTIRE LENGTH OF SWALE AND SHALL HAVE A DEPTH OF 6" MINIMUM AND WIDTH NO MORE THAN 5% SWALE BOTTOM WIDTH. ANCHORED PLATE FLOW SPREADER IF USED, SHALL HAVE V-NOTCHES (MAX TOP WIDTH = 5% OF SWALE WIDTH) OR HOLES TO ALLOW PREFERENTIAL EXIT OF LOW FLOWS.
- ⑧ INSTALL CHECK DAMS OR GRADE CONTROL STRUCTURES FOR SLOPES > 6% AT 50' MAXIMUM SPACING TO ACHIEVE A MAXIMUM EFFECTIVE LONGITUDINAL SLOPE OF 6%. FLOW SPREADERS SHALL BE PROVIDED AT INLET AND AT THE BASE OF EACH CHECK DAM SEE FIGURE 3-2.
- ⑨ INSTALL ENERGY DISSIPATOR AT THE INLET OF VEGETATED SWALE.
- ⑩ SWALE LENGTH SHALL BE 100' OR LENGTH REQUIRED TO PROVIDE 10 MINUTES RESIDENCE TIME, WHICH EVER IS GREATER.
- ⑪ INSTALL APPROPRIATE OUTLET STRUCTURE. ACCOMMODATE LOW FLOW CHANNEL AND/OR UNDERDRAIN (IF PRESENT).
- ⑫ AMEND SOILS WITH 2" OF COMPOST TILLED INTO 6" OF NATIVE SOIL UNLESS NATIVE SOIL ORGANIC CONTENT > 10%.

Figure E-11. Vegetated Swale Schematic

General Constraints and Implementation Considerations

- Vegetated swales can be integrated into roadside buffers or parking lot landscaping. For parking lots, if tire curbs are provided and parking stalls are shortened, cars may overhang the vegetated swale.
- Steep terrain and/or a large tributary area may cause erosive flows while limited site slope can cause ponding.
- Vegetated swales should be located in areas without excessive shade to avoid poor vegetation growth. For moderately shaded areas, shade-tolerant plants should be used.
- Vegetated swales should be located away from large trees that may drop leaves or needles. Excessive tree debris may smother the grass or impede the flow through the swale.
- The effectiveness of vegetated swales may be enhanced by adding check dams at approximately 50 foot increments along the length. The check dams maximize retention time within the vegetated swale, decrease flow velocity, and promote particulate settling. However, check dams may not be appropriate if prolonged ponding occurs.
- Vegetated swales need to be connected to downstream stormwater quality control measures. Vegetated swales may also be connected along its length to these features to allow discharge of high flows and stormwater runoff that does not infiltrate.
- Areas to be used for vegetated swales should be clearly marked before site work begins to avoid soil disturbance and compaction during construction. No vehicular traffic, except that specifically used to construct the vegetated swale, should be allowed within 10 feet of the swale areas.
- Stormwater runoff must be diverted around the vegetated swale during the period of vegetation establishment. If diversion is not feasible, the graded and seeded areas should be protected with suitable erosion controls (i.e., silt fences).
- Repair, seed, or re-plant damaged areas immediately.
- The general landscape irrigation system should incorporate the vegetated swale, as applicable.
- Access to the swale inlet and outlet should be safely provided, with ample room for maintenance and operational activities.

Design Specifications

The following sections describe the design specifications for vegetated swales.

Geotechnical

Due to the potential to contaminate groundwater, cause slope instability, and impact surrounding structures, an extensive geotechnical site investigation must be conducted

during the site planning process to verify site suitability for a vegetated swale. All geotechnical investigations must be performed according to the most recent GMED Policy GS 200.1. Soil infiltration rates and the groundwater table depth must be evaluated to ensure that conditions are satisfactory for proper operation of a vegetated swale. The project applicant must demonstrate through infiltration testing, soil logs, and the written opinion of a licensed civil engineer that sufficiently permeable soils exist on-site to allow the construction of a properly functioning vegetated swale.

Vegetated swales can be used wherever local climate and soils permit the establishment and maintenance of an appropriate vegetative cover. Vegetated swales should not be used at sites with a slope greater than 10 percent.

Geometry

- In general, trapezoidal channel shape is assumed for sizing calculations, but a more naturalistic channel cross-section is preferred.
- Vegetated swales designed for water quality treatment purposes only are anticipated to be fairly shallow, generally less than one foot. Therefore, a side slope of 2:1 (H:V) is acceptable. Milder slopes are necessary if turf is used (maximum 3:1 H:V).
- Overall depth from the top of the side walls to the swale bottom shall be at least 12 inches.
- Vegetated swale length can be increased by meandering the swale. Gradual meandering bends in the swale are desirable for aesthetic purposes and to promote slower flow.
- The minimum width of the vegetated swale bottom is two feet to allow for ease of mowing. The maximum width of the vegetated swale bottom is ten feet unless a dividing berm is provided. If a dividing berm is provided, the maximum width of the vegetated swale bottom can be 16 feet.
- The longitudinal slope (along the direction of flow) must be between one and six percent.
 - If the longitudinal slope is less than 1.5 percent and the soils are poorly drained (e.g., silts and clays), then an underdrain must be installed. A soils report to verify soils properties shall be provided for slopes that are less than 1.5 percent.
 - If the longitudinal slope is greater than 6 percent, check dams with vertical drops of 12 inches or less must be provided to achieve a bottom slope of 6 percent or less between the drop structures.
- The lateral slope (horizontal to the direction of flow) is zero (flat) to discourage channelization.

Sizing

The flow capacity of a vegetated swale is a function of the longitudinal slope (parallel to flow), the resistance to flow (e.g., Manning's roughness), and the cross-sectional area. The cross section is normally approximately trapezoidal and the area is a function of the bottom width and side slopes. The vegetated swale should be designed such that the flow does not exceed two-thirds of the height of the vegetation within the swale. Once design specifications have been determined, the resulting flow depth for the design flow is checked. If the depth restriction is exceeded, swale parameters (e.g., longitudinal slope, width) are adjusted to reduce the flow depth.

The following steps are used design a vegetated swale:

Step 1: Calculate the design flow

Vegetated swales must be designed to capture and retain the SWQDv (see Section 6 for SWQDv calculation procedures).

Step 2: Calculate vegetated swale bottom width

The width of the bottom of the vegetated swale is calculated using Manning's equation for open channel flow, as follows:

$$Q = \left(\frac{1.49}{n} \right) \times A \times R^{2/3} \times S^{0.5}$$

Where:

- Q = Design flow rate [ft³/s];
- n = Manning's roughness coefficient;
- A = Flow area [ft²];
- R = Hydraulic radius [ft] = area divided by the wetted perimeter; and
- S = Channel slope [ft/ft].

For shallow flow depths in vegetated swales, channel side slopes are ignored in the calculation of bottom width. Use the following equation (a simplified form of Manning's formula) to estimate the vegetated swale bottom width:

$$b = \frac{Q \times n_s}{1.49 \times y^{1.67} \times s^{0.5}}$$

Where:

- b = Bottom width of vegetated swale [ft]
- Q = Design flow rate [ft³/s];
- n_s = Manning's roughness coefficient (use 0.2 for shallow conditions);
- y = Design flow depth [ft]; and
- s = Longitudinal slope (along direction of flow) [ft/ft].

Proceed to Step 3 if the calculated bottom width is between two and ten feet. A minimum two-foot bottom width is required. Therefore, if the calculated bottom width is less than two feet, increase the width to two feet, and recalculate the design flow depth, y , using the same Q and n_s , but with b equal to two feet.

The maximum allowable bottom width is ten feet; therefore if the calculated bottom width exceeds ten feet, then one of the following steps is necessary to reduce the design bottom width:

- Increase the longitudinal slope (s) to a maximum of 6 feet in 100 feet (0.06 feet per foot);
- Increase the design flow depth (y) to a maximum of four inches; or
- Place a divider lengthwise along the vegetated swale bottom (see Figure E-) at least three-quarters of the vegetated swale length (beginning at the inlet), without compromising the design flow depth and lateral slope requirements. The vegetated swale width can be increased to a maximum of 16 feet if a divider is provided.

Step 3: Determine the design flow velocity

To calculate the design flow velocity through the vegetated swale, use the flow continuity equation:

$$v = \frac{Q}{A}$$

Where:

v = Design flow velocity [ft/s];

Q = Design flow rate [ft³/s]; and

$A = by + Zy^2$ = Cross-sectional area of flow at design depth [ft²] where Z = side slope length per unit height (i.e., $Z = 3$ if side slope is 3:1 H:V) .

If the design flow velocity exceeds 1 ft/s, go back to Step 2 and modify one or more of the design parameters (longitudinal slope, bottom width, or flow depth) to reduce the design flow velocity to 1 ft/s or less. If the design flow velocity is calculated to be less than 1 ft/s, proceed to Step 4. It is ideal to have the design velocity as low as possible to improve treatment effectiveness and reduce vegetated swale length requirements.

Step 4: Calculate vegetated swale length

Use the following equation to determine the length of the vegetated swale to achieve a hydraulic residence time of at least 10 minutes (600 seconds):

$$L = 60 \times t_{hr} \times v$$

Where:

L = Minimum allowable swale length [ft];
 t_{hr} = Hydraulic residence time [s]; and
v = Design flow velocity [ft/s].

The minimum length for a vegetated swale is 100 feet. If the calculated length for the vegetated swale is less than 100 feet, increase the length to a minimum of 100 feet and leaving the bottom width unchanged. If a larger vegetated swale can fit on the project site, consider using a greater length to increase the hydraulic residence time and improve pollutant removal. If the calculated length is too long for the project site or if it would cause layout problems, such as encroachment into shaded areas, proceed to Step 5 to further modify the layout. If the length of the vegetated swale can be accommodated on the project site, proceed to Step 6.

Step 5: Adjust vegetated swale layout to fit on-site

If the length of the vegetated swale calculated in Step 4 is too long for the project site, the length can be reduced (minimum of 100 feet) by increasing the bottom width up to a maximum of 16 feet, as long as the 10-minute retention time is maintained. However, the length cannot be increased in order to reduce the bottom width because Manning's depth-velocity-flow rate relationships would not be preserved. If the bottom width is increased to greater than ten feet, a low flow berm is needed to divide the vegetated swale cross-section in half to prevent channelization.

The length can be adjusted by calculating the top area of the vegetated swale and providing an equivalent top area with the adjusted dimensions.

Calculate the top area of the vegetated swale based on its length in Step 4:

$$A_{top} = (b_i + b_{slope}) \times L_i$$

Where:

A_{top} = Top area at the design depth [ft²];
 b_i = Bottom width calculated in Step 2 [ft];
 b_{slope} = Additional top width above the side slope for the design depth (for 3:1 H:V side slope and a 4-inch water depth, $b_{slope} = 2$ ft) [ft]; and
 L_i = Initial length calculated in Step 4 [ft].

Use the vegetated swale top area and a reduced swale length, L_f , to increase the bottom width using the following equation:

$$L_f = \frac{A_{top}}{(b_f + b_{slope})}$$

Where:

L_f = Reduced vegetated swale length [ft];

A_{top} = Top area at the design depth [ft²];

b_f = Increased bottom width [ft];

b_{slope} = Additional top width above the side slope for the design depth (for 3:1 H:V side slope and a 4-inch water depth, $b_{slope} = 2$ ft) [ft].

Recalculate the design flow velocity according to Step 3 using the revised cross-sectional area based on the increased bottom width. Revise the design as necessary if the design flow velocity exceeds 1 ft/s. If necessary, recalculate to ensure that the 10-minute hydraulic residence time is maintained.

Flow Entrance and Energy Dissipation

An anchored plate flow spreader must be provided at the inlet to the vegetated swale. Equivalent methods for spreading flows evenly throughout the width the swale are acceptable. The specifications for the flow spreader are listed below:

- The top surface of the flow spreader plate shall be level, projecting a minimum of two inches above the ground surface of the vegetated swale, or V-notched with notches six to ten inches on center and one to four inches deep (use shallower notches with closer spacing).
- The flow spreader plate must extend horizontally beyond the bottom width of the vegetated swale to prevent water from eroding the side slope. The horizontal extent should be such that the bank is protected for all flows up to the SWQDv that will enter the swale.
- Flow spreader plates must be securely fixed in place.
- Flow spreader plates may be made of either concrete, stainless steel, or other durable material.
- Anchor posts are constructed of four inches square of concrete, tubular stainless steel, or other material resistant to decay.

The flow spreader will quickly dissipate the entrance velocity and distribute flow uniformly across the whole vegetated swale. If check dams are used to reduce the longitudinal slope, a flow spreader must be installed at the toe of each vertical drop according to the specifications listed in the following section (Check Dams). If flow is to be introduced through LACDPW-approved curb cuts, the pavement should be placed slightly above the elevation of the vegetated areas. Curb cuts should be at least 12 inches wide to prevent clogging.

The maximum SWQDv flow velocity should not exceed 1.0 ft/s in order to promote settling, keep vegetation upright, and prevent scouring or resuspension of deposited sediment.

Check Dams

If check dams are required, they can be designed out of a number of different materials, including riprap, earthen berms, or removal stop logs. Check dams must be placed to achieve the desired slope (less than 6 percent) and desired velocity (less than 1 ft/s for the SWQDv) at a maximum of 50 feet apart. If riprap is used, the material should consist of well-graded stone consisting of a mixture of rock sizes. The following is an example of an acceptable gradation:

Particle Size	% Passing by Weight
24 in	100%
15 in	75%
9 in	50%
4 in	10%

Swale Divider

- If a swale divider is used, the divider should be constructed of a firm material that will resist weathering and not erode, such as concrete or compacted soil seeded with grass. Use of treated wood is prohibited. Selection of divider material must take into account maintenance activities, such as mowing.
- The divider must have a minimum height of one inch greater than the design depth.
- Earthen berms should be no steeper than 2:1(H:V).
- Material other than earth must be embedded to a depth sufficient to be stable.

Water Depth and Dry Weather Flow Drain

- The water depth in the vegetated swale should not exceed four inches (or two-thirds of the expected vegetation height) except for frequently mowed turf swales. For mowed turf swales, the water depth should not exceed two inches.
- A low flow drain must be provided for dry weather flows extending the entire length of the swale. The drain should have a minimum depth of six inches and a width no more than five percent of the calculated bottom swale width. The width of the drain is in addition to the required bottom width. If an anchored plate is used for flow spreading at the swale inlet, the plate wall must have V-notches (maximum top width = five percent of swale width) or holes to allow low flow into the drain. If an underdrain is installed, the vegetated swale does not require a low flow drain.

Underlying Base

Vegetated swale soils must be amended with two inches of well-rotted compost, unless the organic content is already greater than ten percent. The compost must be mixed into the native soils to a depth of six inches to prevent soil layering and washout of compost. The compost must contain no sawdust, green or under-composted material, or any other toxic or harmful substance. It should contain no unsterilized manure, which can result in high levels of pathogen indicators (coliform bacteria) in stormwater runoff.

Underdrain

An underdrain can be installed for a vegetated swale to collect and discharge stormwater runoff that has been filtered through the soil media, but not infiltrated, to another stormwater quality control measure, storm drain system, or receiving water. If an underdrain is provided, the underdrain shall have a mainline diameter of eight inches using slotted PVC SDR 26 or PVC C9000. Slotted PVC allows for pressure water cleaning and root cutting, if necessary. The slotted pipe should have two to four rows of slots cut perpendicular to the axis of the pipe or at right angles to the pitch of corrugations. Slots should be 0.04 to 0.1 inches wide with a length of 1 to 1.25 inches. Slots should be longitudinally-spaced such that the pipe has a minimum of one square inch opening per lineal foot and should face down.

The underdrain should be placed in a gravel envelope (Class 2 Permeable Material per Caltrans Spec. 68-1.025) that measures three feet wide and six inches deep. The underdrain is elevated from the bottom of the vegetated swale by six inches within the gravel envelope to create a fluctuating anaerobic/aerobic zone below the underdrain to facilitate denitrification within the anaerobic/anoxic zone and reduce nutrient concentrations. The top and sides of the underdrain pipe should be covered with gravel to a minimum depth of 12 inches. The underdrain and gravel envelope should be covered with a geomembrane liner to prevent clogging. The following aggregate should be used for the gravel envelope:

Particle Size (ASTM D422)	% Passing by Weight
¾ inch	100%
¼ inch	30-60%
#8	20-50%
#50	3-12%
#200	0-1%

Underdrains should be sloped at a minimum of 0.5 percent, and must drain freely to an acceptable discharge point.

Clean-out risers with diameters equal to the underdrain pipe must be placed at the terminal ends of the underdrain and can be incorporated into the flow spreader and outlet structure to minimize maintenance obstacles in the vegetated swale.

Intermediate clean-out risers may also be placed in the check dams or grade control structures. The clean-out risers shall be capped with a lockable screw cap.

Hydraulic Restriction Layer

A geomembrane liner must be used to wrap the drain rock. The geomembrane liner must meet the minimum requirements presented in Table E-20.

Table E-20. Geomembrane Liner Specifications for Vegetated Swales

Parameter	Test Method	Specification
Trapezoidal Tear	ASTM D4533	40 lbs (minimum)
Permeability	ASTM D4491	0.2 cm/sec (minimum)
AOS (sieve size)	ASTM D4751	#60 – #70 (minimum)
Ultraviolet Resistance	ASTM D4355	>70%

Vegetation

Swales must be vegetated to provide adequate treatment of stormwater runoff. It is important to maximize water contact with vegetation and the soil surface. The swale should be vegetated with a mix of erosion-resistant plant species that effectively bind the soil. A diverse selection of low growing plants that thrive under the specific site, climatic, and watering conditions should be specified. A mixture of dry-area and wet-area grass species that can continue to grow through silt deposits is most effective. Native or adapted grasses are preferred because they generally require less fertilizer and maintenance and are more drought-tolerant than exotic plants. Consult with a landscape or erosion control specialist for project-specific recommendations on grass seed, fertilizer, and mulching applications to ensure healthy grass growth. Suitable plant types can also be found by referring to various online sources such as:

- Calflora (<http://calflora.org>), which is a database of wild California plants that include plant characteristics and photos.
- California Invasive Plant Council (<http://www.cal-ipc.org>), which is a listing of invasive, non-native plants of California.
- Los Angeles River Master Plan Landscaping Guidelines and Plant Palettes (http://ladpw.org/wmd/watershed/LA/LAR_planting_guidelines_webversion.pdf), which is a guidance document providing a listing of native plant communities in the Los Angeles area.
- The Jepson Online Interchange California Floristics (<http://ucjeps.berkeley.edu/interchange.html>), which is a database that provides information on identification, taxonomy, distribution, ecology, relationships, and diversity of California vascular plants.

- VegSpec (<http://catalog.data.gov/dataset/vegspec>), which is a web-based decision support system that assists land managers in the planning and design with vegetative establishment practices.
- United States Department of Agriculture (<http://plants.usda.gov/java>), which is an extensive database of native and non-native plants of the United States with over 100 plant characteristics.

Vegetation should meet the following specifications:

- Above the design elevation, a typical lawn mix or landscape plants can be used provided they do not shade the vegetated swale.
- Drought-tolerant grasses should be specified to minimize irrigation requirements. Irrigation is required if seeds are planted in spring or summer. A permanent irrigation system may provide maximum water quality performance.
- Vegetative cover should be at least four inches in height, although six inches is preferred.

Irrigation System

Provide an irrigation system to maintain viability of vegetation, if applicable. The irrigation system must be designed to local code or ordinance specifications.

Restricted Construction Materials

Use of pressure-treated wood or galvanized metal at or around the vegetated swale is prohibited.

Maintenance Requirements

Maintenance and regular inspections are important for proper function of vegetated swales. The following are general maintenance requirements:

- Inspect vegetated swales for erosion or damage to vegetation after every storm greater than 0.75 inches. Vegetated swales should be checked for debris and litter and areas of sediment accumulation.
- Remove sediment, as needed, if vegetation growth is inhibited in more than ten percent of the swale or if sediment is blocking even distribution and entry of water. Re-plant and/or re-seed vegetation, as needed, following sediment removal activities to reestablish vegetation.
- Remove sediment and debris from the flow spreader if it is blocking flows. Repair splash pads, as needed, to prevent erosion. Check and re-level the flow spreader if necessary.
- Stabilize slopes with appropriate erosion control measures when native soil is exposed or erosion channels are forming.

VEG-4: Vegetated Swales

- Check to ensure that vegetated swales drain within 96 hours following a storm event. If the swale does not drain within 96 hours, till the swale if compaction or clogging occurs and re-vegetate.
- Inspect, and clean if necessary, the underdrain pipe.
- Eliminate standing water to prevent vector breeding.
- Inspect vegetation for health and density to ensure that it is providing sufficient treatment and protecting the underlying soils from erosion. As needed, conduct the following maintenance activities for the vegetation:
 - Replenish mulch as needed to ensure survival of vegetation.
 - Prune vegetation, large shrubs, or trees that interfere with swale operation.
 - Remove fallen leaves and debris from deciduous plant foliage.
 - Mow grassy swales to maintain grass at a height of four to six inches and remove grass clippings.
 - Remove and replace invasive vegetation with native vegetation. For more information on invasive weeds, including biology and control of listed weeds, refer to the “encycloweedia” located at the California Department of Food and Agriculture website (http://www.cdfa.ca.gov/plant/ipc/encycloweedia/encycloweedia_hp.htm) or the California Invasive Plant Council website (www.cal-ipc.org).
 - Remove dead vegetation if greater than ten percent of area coverage or when swale function is impaired. Replace and establish vegetation before the wet season to maintain cover density and control erosion where soils are exposed.
- Inspect, and repair if necessary, check dams that are causing altered water flow and/or channelization. Remove obstructions as needed.
- Remove all trash and debris, sediment, visual contamination (i.e., oils), noxious or nuisance weeds.

A summary of potential problems that may need to be addressed by maintenance activities is presented in Table E-21.

The County requires execution of a maintenance agreement to be recorded by the property owner for the on-going maintenance of any privately-maintained stormwater quality control measures. The property owner is responsible for compliance with the maintenance agreement. A sample maintenance agreement is presented in Appendix H.

VEG-4: Vegetated Swales

Table E-21. Vegetated Swale Troubleshooting Summary

Problem	Conditions When Maintenance Is Needed	Maintenance Required
Sediment Accumulation	Sediment depth exceeds two inches or covers vegetation	Remove sediment without disturbing vegetation. Ensure that the vegetated swale is level from side to side and drains freely to the outlet when sediment is removed.
Trash and Debris	Trash and debris > 5 ft ³ /1,000 ft ²	Remove and dispose of trash and debris.
Standing Water	Standing water observed more than 96 hours after storm event	Inspect, and clean as needed, the underdrain to ensure proper function. Clear clogs as needed. Till surface and re-vegetate if necessary.
Flow Spreader	Flow spreader is uneven or flow is not evenly distributed into the vegetated swale	Remove obstructions. Clean and re-level flow spreader as needed.
Excessive Shading	Poor vegetation growth	Prune overhanging limbs and bushy vegetation
Erosion	Presence of erosion or channelization	Repair ruts or bare areas less than 12 inches wide with crushed gravel. Re-grade channel if necessary. Inspect flow spreader to ensure that flow is evenly distributed. Re-vegetated if necessary.
Contaminants and Pollution	Any evidence of oil, gasoline, contaminants, or other pollutants	Remove any evidence of visual contamination from floatables such as oil and grease.
Vegetation	Overgrown vegetation	Mow and prune vegetation as appropriate.
	Presence of invasive, poisonous, nuisance, or noxious vegetation or weeds	Remove this vegetation and plant native species as needed.
Inlet/Overflow	Inlet/overflow areas clogged with sediment and/or debris	Remove material.
	Overflow pipe blocked or broken	Repair as needed.

VEG-5: Vegetated Filter Strip



Description

Filter strips are vegetated areas designed to treat sheet flow stormwater runoff from adjacent impervious surfaces or intensive landscaped areas such as golf courses. Filter strips decrease stormwater runoff velocity, remove suspended solids and associated pollutants, and provide some infiltration into underlying soils. While some assimilation of dissolved pollutants may occur, filter strips are generally more effective in trapping sediment and particulate-bound metals, nutrients, and pesticides.

Filter strips are more effective when stormwater runoff passes through the vegetation and thatch layer in the form of shallow, uniform flow. Biological and chemical processes may help break down pesticides, uptake metals, and use nutrients that are trapped in the filter strip.

Vegetated filter strips rely on dense vegetation with a thick thatch, growing on a moderately permeable soil, and are well-suited to treat stormwater runoff from roads and highways, driveways, roof downspouts, small parking lots, and other impervious surfaces. They are also good for use as buffers between developed areas and natural drainages. Vegetated filter strips are typically used to provide pretreatment prior to bioretention, infiltration, and biofiltration devices.

A schematic of a typical vegetated filter strip is presented in Figure E-12.

LID Ordinance Requirements

Vegetated filter strips can be used as a stormwater quality control measure to treat stormwater runoff for the following alternative compliance measures:

- Off-site infiltration;
- Groundwater replenishment projects; and
- Off-site retrofit of existing development.

The project applicant must ensure that all pollutants of concern are addressed when using a vegetated filter strip (see Section 7.4). The following table identifies the pollutants of concern that are treated to the water quality benchmark (see Table 7-2 of the LID Standards Manual) by a vegetated filter strip:

VEG-5: Vegetated Filter Strip

Pollutant of Concern	Treated by Vegetated Filter Strip?
Suspended solids	No
Total phosphorus	No
Total nitrogen	Yes
Total Kjeldahl nitrogen	No
Cadmium, total	Yes
Chromium, total	Yes
Copper, total	No
Lead, total	Yes
Zinc, total	No

Source: Treatment Best Management Practices Performance, Los Angeles Regional Water Quality Control Board, December 9, 2013.

Advantages

- Is easy to install
- Reduces peak stormwater runoff flows during small storm events
- Enhances site aesthetics
- Requires little maintenance

Disadvantages

- May not be appropriate for industrial sites or locations with contaminated soils or where spills may occur because of the potential threat to groundwater contamination
- Is not suitable for areas with steep slopes
- May not be effective and may even erode when flow velocities are high if the grass cover is not properly maintained
- May be difficult to avoid channelization
- Requires irrigation, which may conflict with water conservation ordinances for landscape requirements, to maintain vegetation

VEG-5: Vegetated Filter Strip

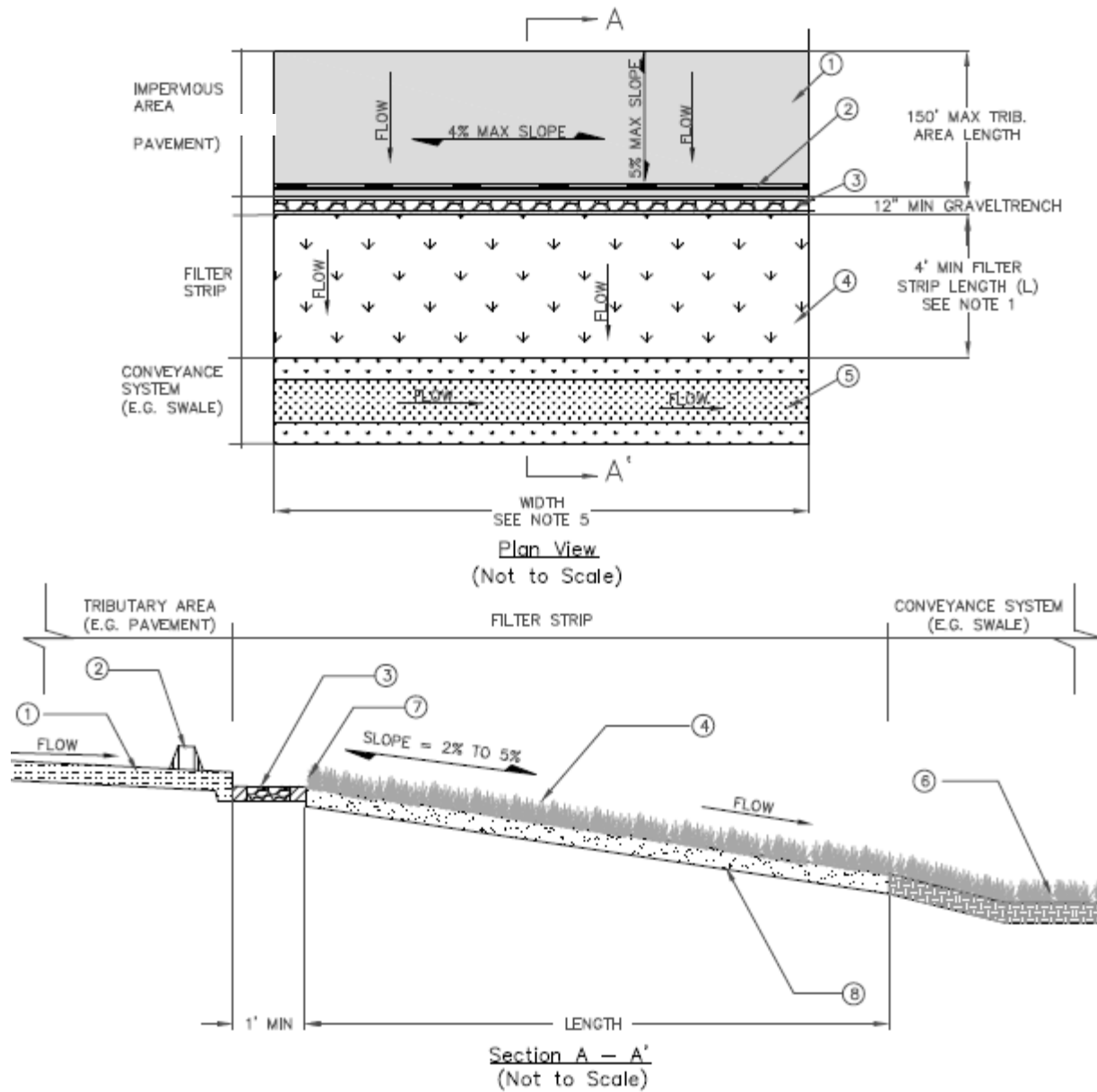

NOTES:

- ① MAXIMUM LENGTH OF IMPERVIOUS TRIBUTARY AREA SHALL BE 150'.
- ② OPTIONAL SLOTTED WHEEL STOPS MAY BE USED.
- ③ GRAVEL TRENCH 6" DEEP BY 12" WIDE MIN SHALL BE PROVIDED.
- ④ VEGETATED FILTER STRIP SURFACE SLOPE SHALL BE BETWEEN 2% TO 5%. WIDTH MUST BE EQUAL OR GREATER THAN THE WIDTH OF THE TRIBUTARY AREA.
- ⑤ CONVEYANCE SYSTEM WIDTH MUST BE EQUAL OR GREATER THAN THE WIDTH OF THE TRIBUTARY AREA.
- ⑥ INSTALL SWALE OR OTHER CONVEYANCE SYSTEM DOWNSTREAM OF FILTER STRIP.
- ⑦ TOP OF FILTER STRIP SHALL BE 2" - 5" BELOW TOP OF ADJACENT PAVEMENT.
- ⑧ AMEND SOILS WITH 2" OF COMPOST TILLED INTO 6" OF NATIVE SOIL UNLESS NATIVE SOIL ORGANIC CONTENT > 10%.

Figure E-12. Vegetated Filter Strip Schematic

General Constraints and Implementation Considerations

- The effectiveness of a vegetated filter strip depends on having an evenly distributed sheet flow, the size of the contributing area, and the associated volume of stormwater runoff to be treated.
- Integrate vegetated filter strips into open space buffers and other landscape areas.
- For parking lot design, stalls can be shortened if tire curbs are provided around the vegetated filter strip perimeter and cars are allowed to overhang the vegetated filter strip.
- The potential for mosquitoes due to standing water will be greatly reduced or eliminated if the vegetated filter strip is properly designed, constructed, and operated.
- Stormwater runoff must be diverted around the vegetated filter strip during period of vegetation establishment. Where stormwater runoff diversion is not feasible, cover graded and seeded areas with suitable temporary erosion controls (i.e., silt fences).
- Repair, seed, and re-plant damaged areas immediately.
- The general landscape irrigation system should incorporate the vegetated filter strip, as applicable.

Design Specifications

The following sections describe the design specifications for vegetated filter strips.

Geotechnical

Due to the potential to contaminate groundwater, cause slope instability, and impact surrounding structures, an extensive geotechnical site investigation must be conducted during the site planning process to verify site suitability for a vegetated filter strip. All geotechnical investigations must be performed according to the most recent GMED Policy GS 200.1. Soil infiltration rates and the groundwater table depth must be evaluated to ensure that conditions are satisfactory for proper operation of a vegetated filter strip. The project applicant must demonstrate through infiltration testing, soil logs, and the written opinion of a licensed civil engineer that sufficiently permeable soils exist on-site to allow the construction of a properly functioning vegetated filter strip.

Geometry

- The width of the vegetated filter strip surface should extend across the full width of the tributary area. The upstream boundary of the vegetated filter strip should be located contiguous to the developed area.

VEG-5: Vegetated Filter Strip

- The length (in direction of flow) should be between 15 and 150 feet. A minimum length of 25 feet is preferred. Vegetated filter strips used for pretreatment must be at least four feet long (in direction of flow).
- Vegetated filter strips should be designed on slopes (parallel to the direction of flow) between two and four percent. Steeper slopes tend to result in concentrated flow. Slopes less than two percent can result in ponding.
- The lateral slope of the vegetated filter strip (parallel to the edge of the pavement, perpendicular to the direction of flow) must be four percent or less.
- Grading should be even because a vegetated filter strip with uneven grading perpendicular to the flow path will develop flow channels over time.
- The top of the vegetated filter strip should be installed two to five inches below the adjacent pavement to allow for vegetation and sediment accumulation at the edge of the vegetated filter strip.
- Both the top and toe of the slope should be as flat as possible to encourage sheet flow and prevent channeling and erosion.

Sizing

The flow capacity of a vegetated filter strip is a function of the longitudinal slope (parallel to flow), the resistance to flow (e.g., Manning's roughness), and the width and length of the vegetated filter strip. The slope should be shallow enough to ensure that the depth of water will not exceed one inch over the vegetated filter strip. Similarly, the flow velocity should be less than 1 ft/s. The following steps are used design a vegetated filter strip:

Step 1: Calculate the design flow

Vegetated filter strips must be designed to capture and retain the SWQDv (see Section 6 for SWQDv calculation procedures).

Step 2: Calculate the design flow depth

The design flow depth (d) is calculated based on the width and slope (parallel to the flow path) using a modified Manning's equation as follows:

$$d = \left(\frac{Q \times n}{1.49 \times W \times s^{0.5}} \right)^{0.6}$$

Where:

d = Design flow depth [ft];
Q = Design flow rate [ft³/s];
n = Manning's roughness coefficient (0.25-0.30);
W = Width (perpendicular to flow = width of impervious tributary area [ft];
and
s = Slope of vegetated filter strip parallel to flow averaged over the entire width [ft/ft].

If d is greater than one inch, then a smaller slope is required, or the vegetated filter strip cannot be used.

Step 3: Determine the design flow velocity

The design flow velocity is based on the design flow, design flow depth, and width of the vegetated filter strip according to the following equation:

$$v = \frac{Q}{d \times W}$$

Where:

v = Design flow velocity [ft/s];
Q = Design flow rate [ft³/s];
d = Design flow depth [ft]; and
W = Width (perpendicular to flow = width of impervious tributary area [ft].

Step 4: Calculate vegetated filter strip length

Determine the required length (L) to achieve a hydraulic residence time of at least 10 minutes (600 seconds):

$$L = 60 \times t_{hr} \times v$$

Where:

L = Minimum allowable vegetated filter strip length [ft];
t_{hr} = Hydraulic residence time [s]; and
v = Design flow velocity [ft/s].

Flow Entrance and Energy Dissipation

Stormwater runoff entering a vegetated filter strip must not be concentrated. A flow spreader must be installed at the edge of the pavement to uniformly distribute the flow along the entire width of the vegetated filter strip.

- At a minimum, a gravel flow spreader (gravel-filled trench) must be placed between the tributary area and the vegetated filter strip, and meet the following requirements:
 - The gravel flow spreader should be a minimum of 6 inches deep and should be 12 inches wide.
 - The gravel should be a minimum of one inch below the pavement surface.
 - Where the ground is not level, the gravel spreader must be installed so that the bottom of the gravel trench and outlet lip are level.
 - Along roadways, gravel flow spreaders must be placed and designed in accordance with LACDPW road design specifications for compacted road shoulders.
- Curb ports and interrupted curbs may be used only in conjunction with a gravel spreader to better ensure that water sheet-flows onto the vegetated filter strip, provided:
 - Curb ports use fabricated openings that allow concrete curbing to be poured or extruded while still providing an opening through the curb to admit water to the vegetated filter strip. Interrupted curbs are sections of curb placed to have gaps spaced at regular intervals along the total width of the treatment area. Openings or gaps in the curb should be at regular intervals, but at least every six feet. The width of each opening should be a minimum of 11 inches.
 - At a minimum, gaps should be every six feet to allow distribution of flows into the vegetated filter strip before they become too concentrated. The opening should be a minimum of 11 inches. Approximately 15 percent or more of the curb section length should be in open ports, and as a general rule, no opening should discharge more than 10 percent of the overall flow entering the vegetated filter strip.
- Energy dissipaters are needed for a vegetated filter strip if a sudden slope drop occurs, such as locations where flows in a vegetated filter strip pass over a rocker or retaining wall aligned perpendicular to the direction of flow. Adequate energy dissipation at the base of the drop section can be provided by a riprap pad.

The maximum SWQDv flow velocity should not exceed 1.0 ft/s in order to promote settling, keep vegetation upright, and prevent scouring or resuspension of deposited sediment.

Underlying Base

Vegetated filter strip soils must be amended with two inches of well-rotted compost, unless the organic content is already greater than ten percent. The compost must be mixed into the native soils to a depth of six inches to prevent soil layering and washout of compost. The compost must contain no sawdust, green or under-composted

material, or any other toxic or harmful substance. It should contain no unsterilized manure, which can result in high levels of pathogen indicators (coliform bacteria) in stormwater runoff.

Underdrain

An underdrain can be installed for a vegetated filter strip to collect and discharge stormwater runoff that has been filtered through the soil media, but not infiltrated, to another stormwater quality control measure, storm drain system, or receiving water. If an underdrain is provided, the underdrain shall have a mainline diameter of eight inches using slotted PVC SDR 26 or PVC C9000. Slotted PVC allows for pressure water cleaning and root cutting, if necessary. The slotted pipe should have two to four rows of slots cut perpendicular to the axis of the pipe or at right angles to the pitch of corrugations. Slots should be 0.04 to 0.1 inches wide with a length of 1 to 1.25 inches. Slots should be longitudinally-spaced such that the pipe has a minimum of one square inch opening per lineal foot and should face down.

The underdrain should be placed in a gravel envelope (Class 2 Permeable Material per Caltrans Spec. 68-1.025) that measures three feet wide and six inches deep. The underdrain is elevated from the bottom of the vegetated filter strip by six inches within the gravel envelope to create a fluctuating anaerobic/aerobic zone below the underdrain to facilitate denitrification within the anaerobic/anoxic zone and reduce nutrient concentrations. The top and sides of the underdrain pipe should be covered with gravel to a minimum depth of 12 inches. The underdrain and gravel envelope should be covered with a geomembrane liner to prevent clogging. The following aggregate should be used for the gravel envelope:

Particle Size (ASTM D422)	% Passing by Weight
¾ inch	100%
¼ inch	30-60%
#8	20-50%
#50	3-12%
#200	0-1%

Underdrains should be sloped at a minimum of 0.5 percent, and must drain freely to an acceptable discharge point.

Clean-out risers with diameters equal to the underdrain pipe must be placed at the terminal ends of the underdrain and can be incorporated into the flow spreader and outlet structure to minimize maintenance obstacles in the vegetated filter strip. The clean-out risers shall be capped with a lockable screw cap.

Hydraulic Restriction Layer

A geomembrane liner must be used to wrap the drain rock. The geomembrane liner must meet the minimum requirements presented in Table E-32.

Table E-32. Geomembrane Liner Specifications for Vegetated Filter Strips

Parameter	Test Method	Specification
Trapezoidal Tear	ASTM D4533	40 lbs (minimum)
Permeability	ASTM D4491	0.2 cm/sec (minimum)
AOS (sieve size)	ASTM D4751	#60 – #70 (minimum)
Ultraviolet Resistance	ASTM D4355	>70%

Vegetation

Filter strips must be vegetated to provide adequate treatment of stormwater runoff. It is important to maximize water contact with vegetation and the soil surface. The filter strip should be vegetated with a mix of erosion-resistant plant species that effectively bind the soil. Native or adapted grasses are preferred because they generally require less fertilizer and maintenance and are more drought-tolerant than exotic plants. Consult with a landscape or erosion control specialist for project-specific recommendations on grass seed, fertilizer, and mulching applications to ensure healthy grass growth.

Suitable plant types can also be found by referring to various online sources such as:

- Calflora (<http://calflora.org>), which is a database of wild California plants that include plant characteristics and photos.
- California Invasive Plant Council (<http://www.cal-ipc.org>), which is a listing of invasive, non-native plants of California.
- Los Angeles River Master Plan Landscaping Guidelines and Plant Palettes (http://ladpw.org/wmd/watershed/LA/LAR_planting_guidelines_webversion.pdf), which is a guidance document providing a listing of native plant communities in the Los Angeles area.
- The Jepson Online Interchange California Floristics (<http://ucjeps.berkeley.edu/interchange.html>), which is a database that provides information on identification, taxonomy, distribution, ecology, relationships, and diversity of California vascular plants.
- VegSpec (<http://catalog.data.gov/dataset/vegspec>), which is a web-based decision support system that assists land managers in the planning and design with vegetative establishment practices.
- United States Department of Agriculture (<http://plants.usda.gov/java>), which is an extensive database of native and non-native plants of the United States with over 100 plant characteristics.

Vegetation should meet the following specifications:

- Sod (turf) can be used instead of grass seed as long as there is complete coverage.
- Grass or turf should be maintained at a height of two to four inches. Regular mowing is often required to maintain the cover.
- Trees or shrubs must not be used because they shade turf.

Irrigation System

Provide an irrigation system to maintain viability of vegetation, if applicable. The irrigation system must be designed to local code or ordinance specifications.

Restricted Construction Materials

Use of pressure-treated wood or galvanized metal at or around the vegetated filter strip is prohibited.

Maintenance Requirements

Maintenance and regular inspections are important for proper function of vegetated filter strips. The following are general maintenance requirements:

- Inspect vegetated filter strip for erosion or damage to vegetation after every storm greater than 0.75 inches. Vegetated filter strips should be checked for debris and litter and areas of sediment accumulation.
- Remove sediment, as needed, if vegetation growth is inhibited in more than ten percent of the filter strip or if sediment is blocking even distribution and entry of water. Re-plant and/or re-seed vegetation, as needed, following sediment removal activities to reestablish vegetation.
- Remove sediment and debris from the flow spreader if it is blocking flows. Repair splash pads, as needed, to prevent erosion. Check and re-level the flow spreader if necessary.
- Eliminate standing water to prevent vector breeding.
- Inspect vegetation for health and density to ensure that it is providing sufficient treatment and protecting the underlying soils from erosion. As needed, conduct the following maintenance activities for the vegetation:
 - Replenish mulch as needed to ensure survival of vegetation.
 - Prune vegetation, large shrubs, or trees that interfere with filter strip swale operation.
 - Remove fallen leaves and debris from deciduous plant foliage.
 - Mow grassy swales to maintain grass at a height of four to six inches and remove grass clippings.

VEG-5: Vegetated Filter Strip

- Remove and replace invasive vegetation with native vegetation. For more information on invasive weeds, including biology and control of listed weeds, refer to the “encycloweedia” located at the California Department of Food and Agriculture website (http://www.cdfa.ca.gov/plant/ipc/encycloweedia/encycloweedia_hp.htm) or the California Invasive Plant Council website (www.cal-ipc.org).
- Remove dead vegetation if greater than 10 percent of area coverage or when filter strip function is impaired. Replace and establish vegetation before the wet season to maintain cover density and control erosion where soils are exposed.
- Remove all trash and debris, sediment, visual contamination (i.e., oils), noxious or nuisance weeds.

A summary of potential problems that may need to be addressed by maintenance activities is presented in Table E-22.

The County requires execution of a maintenance agreement to be recorded by the property owner for the on-going maintenance of any privately-maintained stormwater quality control measures. The property owner is responsible for compliance with the maintenance agreement. A sample maintenance agreement is presented in Appendix H.

VEG-5: Vegetated Filter Strip

Table E-22 Vegetated Filter Strip Troubleshooting Summary

Problem	Conditions When Maintenance Is Needed	Maintenance Required
Sediment Accumulation	Sediment depth exceeds two inches or covers vegetation	Remove sediment without disturbing vegetation. Ensure that the vegetated filter strip is level from side to side and drains freely to the outlet when sediment is removed.
Trash and Debris	Trash and debris > 5 ft ³ /1,000 ft ²	Remove and dispose of trash and debris.
Standing Water	Standing water observed more than 48 hours after storm event	Inspect, and clean as needed, the underdrain to ensure proper function. Clear clogs as needed. Till surface and re-vegetate if necessary.
Flow Spreader	Flow spreader is uneven or flow is not evenly distributed into the vegetated swale	Remove obstructions. Clean and re-level flow spreader as needed.
Excessive Shading	Poor vegetation growth	Prune overhanging limbs and bushy vegetation
Erosion	Presence of erosion or channelization	Repair ruts or bare areas less than 12 inches wide with crushed gravel. Re-grade channel if necessary. Inspect flow spreader to ensure that flow is evenly distributed. Re-vegetated if necessary.
Contaminants and Pollution	Any evidence of oil, gasoline, contaminants, or other pollutants	Remove any evidence of visual contamination from floatables such as oil and grease.
Vegetation	Overgrown vegetation	Mow and prune vegetation as appropriate.
	Presence of invasive, poisonous, nuisance, or noxious vegetation or weeds	Remove this vegetation and plant native species as needed.
Inlet/Overflow	Inlet/overflow areas clogged with sediment and/or debris	Remove material.
	Overflow pipe blocked or broken	Repair as needed.

T-1: Sand Filter



Description

A sand filter operates similar to a biofiltration facility; however, instead of filtering stormwater runoff through biofiltration soil media, the stormwater runoff is filtered through a constructed sand bed with an underdrain system. Stormwater runoff enters the filter and spreads over the surface. As flows increase, water backs up on the surface of the filter where it is held until it can percolate through the sand. The treatment pathway is vertical (downward through the sand). High flows in excess of the design volume are diverted to prevent overloading of

the filter. Water that has percolated through the sand is collected with an underdrain that conveys the water to another stormwater quality control measure, storm drain system, or receiving water. As stormwater runoff passes through the sand, pollutants are trapped in the small pore spaces between sand grains or are adsorbed to the sand surface.

A schematic of a typical sand filter is presented in Figure E-13.

LID Ordinance Requirements

Sand filters can be used as a stormwater quality control measure to treat stormwater runoff for the following alternative compliance measures:

- Off-site infiltration;
- Groundwater replenishment projects; and
- Off-site retrofit of existing development.

The project applicant must ensure that all pollutants of concern are addressed when using a sand filter (see Section 7.4). The following table identifies the pollutants of concern that are treated to the water quality benchmark (see Table 7-2 of the LID Standards Manual) by a sand filter:

Pollutant of Concern	Treated by Sand Filter?
Suspended solids	Yes
Total phosphorus	Yes
Total nitrogen	Yes
Total Kjeldahl nitrogen	Yes
Cadmium, total	Yes
Chromium, total	Yes
Copper, total	Yes
Lead, total	Yes
Zinc, total	Yes

Source: Treatment Best Management Practices Performance, Los Angeles Regional Water Quality Control Board, December 9, 2013.

Advantages

- Provides effective treatment through settling and filtering with a relatively small footprint
- Can be placed underground
- Is suitable for most soil conditions since presence of permeable native soils is not a requirement
- Reduces peak stormwater runoff flows during small storm events

Disadvantages

- Requires a flat surface
- Does not reduce the volume of stormwater runoff
- May be more expensive to construct than other types of stormwater quality control measures

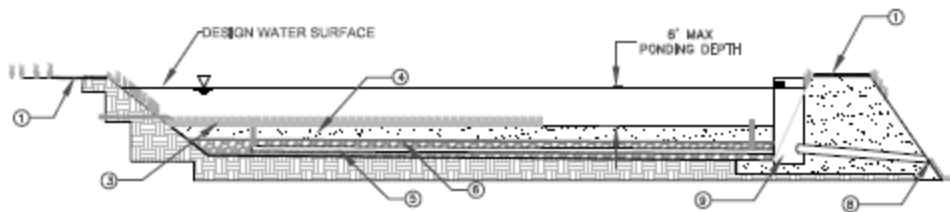
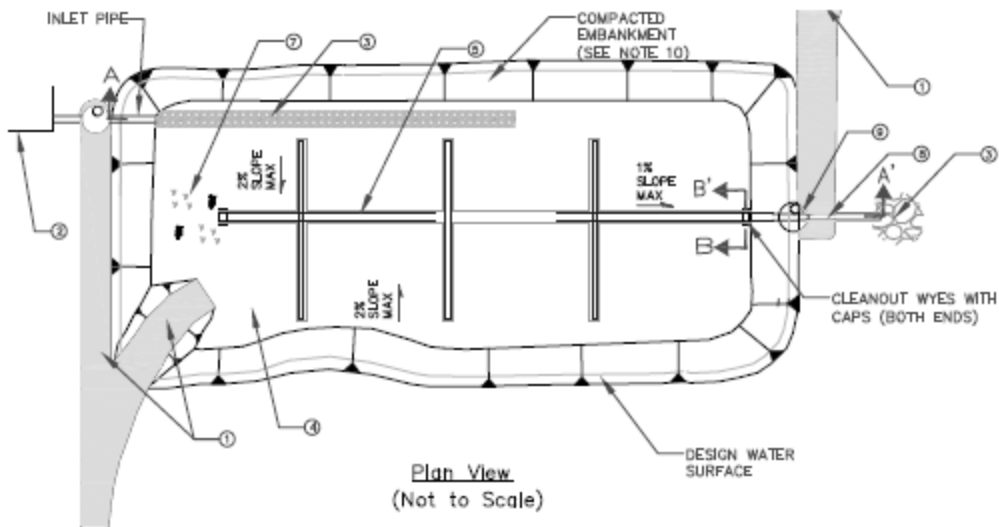

NOTES:

- ① INSTALL MAINTENANCE ACCESS ROAD AND RAMP TO BOTTOM OF SAND FILTER. MAINTENANCE RAMP SHOULD BE PAVED. SLOPE SHOULD NOT EXCEED 12%.
- ② UPSTREAM PRETREATMENT SHALL BE PROVIDED. RECOMMENDED PRETREATMENT OPTIONS INCLUDE SEDIMENTATION / HYDRODYNAMIC DEVICES AND VEGETATED BMPs. IN THE ABSENCE OF PRETREATMENT, INCLUDE SEDIMENT FOREBAY WITH VOLUME EQUAL TO 10-20% OF TOTAL SAND FILTER VOLUME.
- ③ FLOW SPREADER TO EVENLY DISTRIBUTE FLOWS ALONG AT LEAST 20% OF PERIMETER.
- ④ FILTER BED SHALL BE A 24" MINIMUM SAND LAYER ON TOP OF 8" MINIMUM GRAVEL OR DRAIN ROCK BACKFILL.
- ⑤ 6" MINIMUM DIAMETER PERFORATED PIPE UNDERDRAIN. INSTALL AT 0.5% MINIMUM SLOPE.
- ⑥ INSTALL GEOTEXTILE FABRIC OR TRANSITIONALLY GRADED AGGREGATE BETWEEN SAND AND GRAVEL LAYER.
- ⑦ VEGETATION MAY BE PLANTED ON TOP OF FILTER BED. NO TOP SOIL SHALL BE ADDED TO FILTER BED.
- ⑧ SIZE OUTLET PIPE STRUCTURE TO PASS WATER QUALITY DESIGN STORM AND INCLUDE AN EMERGENCY OVERFLOW.
- ⑨ EMERGENCY OVERFLOW STRUCTURE.
- ⑩ SIDE SLOPES SHOULD NOT EXCEED 3:1 UNLESS APPROVED BY AN ENGINEER. SIDE SLOPES SHALL NOT EXCEED 2:1 WITHOUT A SUPPORTING GEOTECHNICAL REPORT.
- ⑪ ¾" - 1½" WASHED DRAIN ROCK OR GRAVEL LAYER.

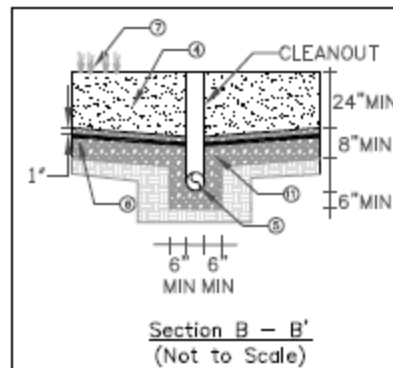

Figure E-73. Sand Filter Schematic

General Constraints and Implementation Considerations

- Sand filters are generally suited for sites where there is no base flow, and the sediment load is relatively low. Pretreatment or upstream stormwater quality control measures to remove large sediment may be required to minimize or prevent clogging. Sand filters should be located away from trees producing leaf litter or areas contributing significantly eroded sediment to prevent clogging.
- Site must have adequate relief between the land surface and stormwater conveyance system to permit vertical percolation through the sand filter and collection and conveyance in the underdrain.
- In areas with high groundwater levels, the underdrain may potentially flood. An impermeable liner must be provided.
- Sand filters are well suited for drier areas and/or urban areas because they do not require vegetation and require less surface space than other stormwater quality control measures. Landscape uses of sand filters are limited due to the few plant species that can survive in sand.
- For underground sand filters, the load-carrying capacity of the filter structure must be considered if it is located under parking lots, driveways, roadways, and certain sidewalks.

Design Specifications

The main challenge associated with sand filters is maintaining the filtration capacity, which is critical to its performance. If the flow entering the sand filter has high sediment concentrations, clogging of the sand filter is likely. Contribution of eroded soils or leaf litter may also reduce the filtration and associated treatment capacity of the sand filter. Sand filters should be designed according to the specifications discussed below.

Pretreatment

Pretreatment is important for all structural stormwater quality control measures, but it is particularly important for sand filters. Pretreatment refers to design features that provide settling of large particles before stormwater runoff enters a stormwater quality control measure in order to reduce the long-term maintenance burden. Pretreatment should be provided to reduce the sediment load entering a sand filter. To ensure that sand filters are effective, the project applicant must incorporate pretreatment devices that provide sediment removal (e.g., vegetated swales, vegetated filter strips, sediment forebays, and proprietary devices).

If a sediment forebay is used for pretreatment to remove coarse solids, it may be constructed with an internal berm made out of earthen embankment material, grouted riprap, or other structurally-sound material.

- The sediment forebay should have a volume equate to 10 to 20 percent of the total sand filter volume.

- A gravity drain outlet from the sediment forebay (minimum four-inch diameter) must extend the entire width of the internal berm.
- The forebay outlet must be off-set from the inflow flow line to prevent short-circuiting.
- Permanent steel post depth markers must be placed in the forebay to identify the settled sediment removal limits at 50 and 100 percent of the forebay sediment storage depth.

Geometry

- Sand filters must be sized to capture and treat the mitigation volume (V_m), or the volume of stormwater runoff that cannot be reliably retained on-site at the project location. Calculation of the mitigation volume is presented in Section 7.
- Sand filters may be designed in any geometric configuration, but rectangular with a 1.5:1 length-to-width ratio or greater is preferred.
- The depth of the sand bed must be at least two feet, but three feet is preferred.
- The maximum depth of storage above the sand bed is six feet. The minimum freeboard is one foot.
- Sand filters must be placed off-line to prevent scouring of the filter bed by high flows. An overflow structure must be included in the sand filter system.
- Interior side slopes up to the emergency overflow structure must be no steeper than 3:1 (H:V) unless stabilization has been approved by a licensed geotechnical engineer. Exterior side slopes shall be no steeper than 2:1 (H:V) unless stabilization has been approved by a licensed geotechnical engineer. For any slope (interior or exterior) greater than 2:1 (H:V), a geotechnical report must be submitted and approved by GMED.
- Walls may be vertical retaining walls, provided: (a) they are constructed of reinforced concrete; (b) a fence, which prevents access, is provided along the top of the wall (see fencing below) or further back; and (c) the design is approved by a licensed civil engineer and LACDPW.

Sizing

A sand filter is designed with two parts: (1) a temporary reservoir to store stormwater runoff, and (2) a sand filter bed through which the stored stormwater runoff must percolate. Usually the reservoir simply occupies the volume on top of the sand bed. The storage volume also determines the hydraulic head over the filter bed surface, which increases the flow rate through the sand. Sand filters are sized using a simple sizing method, which uses standard values to define filter hydraulic characteristics for determining the sand surface area. Alternative sizing methodologies must be prepared with good engineering practices.

Step 1: Determine maximum storage depth of water

Determine the maximum storage depth (d) above the sand filter. This depth is defined as the depth at which water begins to overflow the reservoir and depends on the site topography and hydraulic constraints. The depth is chosen by the designer, but shall be six feet or less.

Step 2: Calculate the mitigation volume

Sand filters must be designed to capture and retain the SWQDv (see Section 6 for SWQDv calculation procedures). Determine the volume of stormwater runoff that must be mitigated, V_M (Section 7).

Step 3: Calculate the sand filter surface area

Surface area is the primary design parameter for the filter bed and is a function of sand permeability, filter bed depth, hydraulic head, and filtration rate. Determine the sand filter surface area using the following equation:

$$A_{sf} = \frac{V_M \times L}{K \times t \times (h + L)}$$

Where:

A_{sf} = Surface area of the sand filter bed [ft²];

V_M = Mitigation volume [ft³];

R = Adjustment factor [use R=0.7];

L = Sand bed depth [ft];

K = Design hydraulic conductivity [use 2 ft/day];

t = Maximum retention time [use 4 days];

h = Average depth of water above the filter bed [ft, use d/2 with d from Step 1].

Flow Entrance and Energy Dissipation

A flow spreader must be installed at the inlet along one side of the sand filter to evenly distribute stormwater runoff across the entire width of the sand filter and to prevent erosion of the filter surface.

- If the sand filter is curved or an irregular shape, a flow spreader must be provided for a minimum of 20 percent of the filter perimeter.
- If the length-to-width ratio of the filter is 2:1 or greater, a flow spreader must be located on the longer side and for a minimum length of 20 percent of the perimeter of the sand filter.
- In other situations, best professional judgment should be used when placing the flow spreader.

Erosion protection must be provided along the first foot of the sand bed adjacent to the flow spreader. Geomembrane liners weighted with sand bags at 15-foot intervals may be used. Quarry spalls may also be used.

Sand Specification

The ideal effective diameter of the sand, d_{10} , should be just small enough to ensure a good quality effluent from the sand filter while preventing penetration of solids to such a depth that it cannot be removed by surface scraping (~2-3 inches). This effective diameter is between 0.20 and 0.35 mm. In addition, the coefficient of uniformity, $C_u = d_{60}/d_{10}$, should be less than 3.

The sand in a filter should consist of a medium sand with very little fines meeting ASTM C33 size gradation (by weight) or equivalent as presented in Table E-23.

Table E-23. Sand Filter Media Sand Specifications

U.S. Sieve Size	Percent Passing by Weight
3/8 inch	100%
U.S. No. 4	95-100%
U.S. No. 8	80-100%
U.S. No. 16	50-85%
U.S. No. 30	25-60%
U.S. No. 50	5-30%
U.S. No. 100	<10%

Finally, the silica (SiO_2) content of the sand should be greater than 95 percent by weight.

Underdrain

The underdrain collects treated stormwater runoff from the sand filter and conveys it downstream to another stormwater quality control measure, storm drain system, or receiving water. The underdrain must have a mainline diameter of eight inches using perforated PVC to allow for pressure water cleaning, if necessary.

- All pipes should be reinforced to withstand the weight of the overburden.
- The underdrain pipe must be sized and perforated as to ensure free draining of the sand filter bed. Round perforations must be at least 0.5-inch in diameter and the pipe must be laid with perforations downward.
- The maximum perpendicular distance between any two lateral collection pipes or from the edge of the filter and the collection pipes is nine feet.
- All pipes must be placed with a minimum slope of 0.5 percent.

- The invert of the underdrain outlet must be above the seasonal high groundwater level, as determined according to the most recent GMED Policy GS 200.1.

The underdrain should be placed in a gravel backfill where at least eight inches of gravel backfill must be maintained over all underdrain pipes, and at least six inches must be maintained on both sides and beneath the pipe to prevent damage by heavy equipment during maintenance. Either drain rock or gravel backfill may be used between pipes. The bottom gravel layer should have a diameter at least twice the size of the openings into the storm drain system. The grains should be hard, preferably rounded, with a specific gravity of at least 2.5, and free of clay, debris and organic impurities.

Clean-out risers with diameters equal to the underdrain must be placed at the terminal ends of all pipes and extend to the surface of the filter. A valve box should be provided for access to the clean-outs and the clean-out assembly must be water tight to prevent short circuiting of the sand filter.

Hydraulic Restriction Layer

Either a geomembrane liner or a 2-inch transition gradation layer (preferred) must be placed between the sand layer and the drain rock or gravel backfill layer. If a geomembrane liner is used, one inch of drain rock or gravel backfill should be placed above the liner. This allows for a transitional zone between sand and gravel and may reduce pooling of water at the liner interface. The geomembrane liner must meet the minimum requirements presented in Table E-24.

Table E-24. Geomembrane Liner Specifications for Sand Filters

Geotextile Property	Value	Test Method
Trapezoidal Tears	40 lbs (minimum)	ASTM D4533
Permeability	0.2 cm/s (minimum)	ASTM D4491
AOS (sieve size)	#60 – #70 (minimum)	ASTM D4751
Ultraviolet Resistance	≥70%	ASTM D4355

Vegetation

The use of vegetation in sand filters is optional. However, no topsoil should be added to the sand filter bed because the fine-grained materials (silt and clay) reduce the hydraulic conductivity of the sand filter. Grass or other vegetation requires selection of species that can tolerate the demanding environment of a sand filter bed. Vegetation that does not receive sufficient dry weather flows must be able to withstand long periods of drought during summer periods followed by periods of saturation during storm events. Sod grown in sand may be used on the surface as long as there is no clay in the sand substrate and the particle size gradation of the substrate meets the sand filter specifications. No other sod shall be used due to the high clay content. A horticultural specialist should be consulted for advice on species selection.

To prevent uses that may compact and damage the filter surface, permanent structures are not permitted on sand filters (i.e., playground equipment).

Exterior Landscaping

Landscaping outside of the sand filter, but within the easement/right-of-way, is required and must adhere to the following specifications such that it will not hinder maintenance operations:

- No trees or shrubs may be planted within ten feet of inlet or outlet pipes or manmade drainage structures such as spillways, flow spreaders, or earthen embankments. Species with roots that seek water, such as willow or poplar, shall not be used within 50 feet of pipes or manmade structures.
- Prohibited non-native plant species will not be permitted.
- Other resources for identifying suitable plant types can be found by consulting a nursery, arborist, landscape architect, or referring to online resources such as:
 - Calflora (<http://calflora.org>), which is a database of wild California plants that include plant characteristics and photos.
 - Los Angeles River Master Plan Landscaping Guidelines and Plant Palettes (http://ladpw.org/wmd/watershed/LA/LAR_planting_guidelines_webversion.pdf), which is a guidance document providing a listing of native plant communities in the Los Angeles area.
 - The Jepson Online Interchange California Floristics (<http://ucjeps.berkeley.edu/interchange.html>), which is a database that provides information on identification, taxonomy, distribution, ecology, relationships, and diversity of California vascular plants.
 - VegSpec (<http://catalog.data.gov/dataset/vegspec>), which is a web-based decision support system that assists land managers in the planning and design with vegetative establishment practices.
 - United States Department of Agriculture (<http://plants.usda.gov/java>), which is an extensive database of native and non-native plants of the United States with over 100 plant characteristics.

Fencing

Safety is provided by fencing of the stormwater quality control measure. Fences shall be designed and constructed in accordance with Title 11, Section 11.48 of the Los Angeles County Code and must be located at or above the top of emergency overflow structure elevation. Shrubs (LACDPW-approved, California-adapted species) may be used to conceal the fencing.

Restricted Construction Materials

The use of pressure-treated wood or galvanized metal at or around the sand filter is prohibited. The use of galvanized fencing is permitted if in accordance with the Fencing requirement above.

Overflow Device

While sand filters may only be placed off-line, an overflow device must still be provided for high flows or in the event the sand filter becomes clogged. The overflow device must be able to safely convey excess stormwater runoff to the downstream conveyance system or other approved discharge point.

Maintenance Access

Maintenance access must be provided to the drainage structures associated with the sand filter (e.g., inlet, overflow or bypass devices) if it is publicly-maintained. Manhole and catch basin lids must be in or at the edge of the access road. An access ramp to the sand filter bottom is required to facilitate the entry of sediment removal (and vegetation maintenance) equipment.

Access roads must meet the following design specifications:

- All access ramps and roads must be paved with a minimum of six inches concrete over three inches of crushed aggregate base material. This requirement may be modified depending on the soil conditions and intended use of the road at the discretion of LACDPW.
- The maximum grade is 12 percent unless otherwise approved by LACDPW.
- Centerline turning radius must be a minimum of 40 feet.
- Access roads less than 500 feet long must have a 12-foot wide pavement within a minimum 15-foot wide bench. Access roads greater than 500 feet long shall have 16-foot wide pavement within a minimum 20-foot wide bench.
- All access roads must terminate with turnaround areas of 40-feet by 40-feet. A hammer type turn around area or a circle drive around the top of the sand filter is also acceptable.
- Adequate double-drive gates and commercial driveways are required at street crossings. Gates should be located a minimum of 25 feet from the street curb except in residential areas where the gates may be located along the property line provided there is adequate sight distance to see oncoming vehicles at the posted speed limit.

Maintenance and regular inspections are important for proper function of sand filters. Sand filters are subject to clogging by fine sediment, oil and grease, and other debris (e.g., trash and organic matter such as leaves). Pretreatment devices and sand filters should be inspected every six months during the first year of operation. Inspection should also occur immediately following a storm event to assess the filtration capacity of

the sand filter. Once the sand filter is performing as designed, the frequency of inspection may be reduced to once per year.

Most maintenance activities should be concentrated on the pretreatment devices, such as vegetated filter strips and vegetated swales upstream of the sand filter to ensure that sediment does not reach the sand filter. Regular inspection should determine if the sediment removal structures require routine maintenance.

A summary of potential problems that may need to be addressed by maintenance activities is presented in Table E-25.

The County requires execution of a maintenance agreement to be recorded by the property owner for the on-going maintenance of any privately-maintained stormwater quality control measures. The property owner is responsible for compliance with the maintenance agreement. A sample maintenance agreement is presented in Appendix H.

Table E-25: Sand Filter Troubleshooting Summary

Problem	Conditions When Maintenance Is Needed	Maintenance Required
Trash and Debris	Trash and debris > 5 ft ³ /1,000 ft ² . In general, there should be no visual evidence of dumping. If less than threshold all trash and debris will be removed as part of next scheduled maintenance.	Remove and dispose of trash and debris.
Contaminants and Pollution	Any evidence of oil, gasoline, contaminants, or other pollutants	Remove any evidence of visual contamination. Dispose of materials contaminated with petroleum hydrocarbons in accordance with applicable laws.
Vegetation	Overgrown vegetation	Mow and trim vegetation to prevent establishment of woody vegetation, and for aesthetics and vector control reasons.
	Presence of invasive, poisonous, nuisance, or noxious vegetation or weeds	Remove this vegetation.
Sediment Accumulation	Accumulation of sediment, debris, and oil/grease in forebay, pretreatment devices, surface, inlet, or overflow structures	Remove sediment, debris, and/or oil/grease.
Decreased Sand Bed Depth	Sand bed depth drops below 18 inches	Restore sand bed depth to 24 inches.
Erosion	Visible evidence of erosion occurring near flow spreader outlet	Eroded areas repaired/reseeded.
Concentrated Flow	Flow spreader uneven or clogged so that flows are not uniformly distributed across the sand filter bed.	Level the flow spreader and clean it so that flows are spread evenly over the sand filter bed.
Standing Water; Water Drainage Rate	Standing water after storm has passed (after 96 hours) and/or flow through the overflow pipes occurs frequently.	Removing accumulated litter on surface and removing and renewing top two to four inches of sand. If this does not resolve the problem, backflush the underdrain pipe if necessary.
Pipe Settlement	If piping has visibly settled more than one inch.	Add fill material to bring pipe back to grade. If erosion is evident around pipe, inspect for cracks or leaks.

T-2: Constructed Wetland

Description

A constructed wetland is a single-stage treatment system consisting of a forebay and permanent pool with aquatic plants. Constructed wetlands typically consist of an inlet with energy dissipation, a sediment forebay for settling out coarse solids and to facilitate maintenance, a base with shallow sections (one to two feet deep) planted with emergent vegetation, deeper areas or micro pools (three to five feet deep), and an outlet structure.



Constructed wetlands function similarly to wet ponds in that influent stormwater runoff mixes with and displaces a permanent pool as it enters the system. The surcharge volume above the permanent pool is slowly released over a specified period (96 hours for SWQDv). Constructed wetlands require a longer release period for the surcharge volume than wet ponds because the depth and volume of the permanent pool for constructed wetlands are less compared to wet ponds. A base flow is required to maintain the permanent water pool. Constructed wetlands also differ from wet ponds because of the extensive presence of aquatic plants. Plants provide energy dissipation and enhance pollutant removal by sedimentation and biological uptake.

Because aquatic vegetation and the associated biological unit processes are a fundamental part of constructed wetlands, it is critical that dry weather base flows exceed evaporation and infiltration losses to prevent loss of aquatic vegetation and to avoid stagnation and vector problems. In situations where dry weather flows are inadequate to support a wetland basin sized for the portion of the SWQDv that is not reliably retained at a project site, an additional source of water may be needed during summer months. Otherwise, the constructed wetland should be sized based on the available flow and the design should handle the portion of the SWQDv that is not reliably retained at a project site.

It is important to note the difference between stormwater wetlands and wetlands that are constructed as part of mitigation requirements. Constructed mitigation wetlands are intended to provide fully-functional habitat similar to the habitat they replace while stormwater wetlands are a stormwater quality control measures designed to capture and treat pollutants to protect receiving waters, including natural wetlands and other ecologically significant habitat. The accumulation of pollutants in sediment and vegetation of stormwater wetlands may impact the health of aquatic biota. As such, periodic sediment and vegetation removal within stormwater wetlands may be required.

These maintenance activities may temporarily interrupt the use of stormwater wetlands by wildlife.

A schematic of a typical constructed wetland is presented in Figure E-14.

LID Ordinance Requirements

Constructed wetlands can be used as a stormwater quality control measure to treat stormwater runoff for the following alternative compliance measures:

- Off-site infiltration;
- Groundwater replenishment projects; and
- Off-site retrofit of existing development.

The project applicant must ensure that all pollutants of concern are addressed when using a constructed wetland (see Section 7.4). The following table identifies the pollutants of concern that are treated to the water quality benchmark (see Table 7-2 of the LID Standards Manual) by a constructed wetland:

Pollutant of Concern	Treated by Constructed Wetland?
Suspended solids	Yes
Total phosphorus	Yes
Total nitrogen	Yes
Total Kjeldahl nitrogen	Yes
Cadmium, total	Yes
Chromium, total	Yes
Copper, total	Yes
Lead, total	Yes
Zinc, total	Yes

Source: Treatment Best Management Practices Performance, Los Angeles Regional Water Quality Control Board, December 9, 2013.

Advantages

- Has the ability to handle and treat stormwater runoff from large tributary areas
- Can provide substantial wildlife habitat and passive recreation
- Can provide significant water quality improvement for many pollutants including dissolved nutrients
- Provides opportunities for education
- Enhances site aesthetics

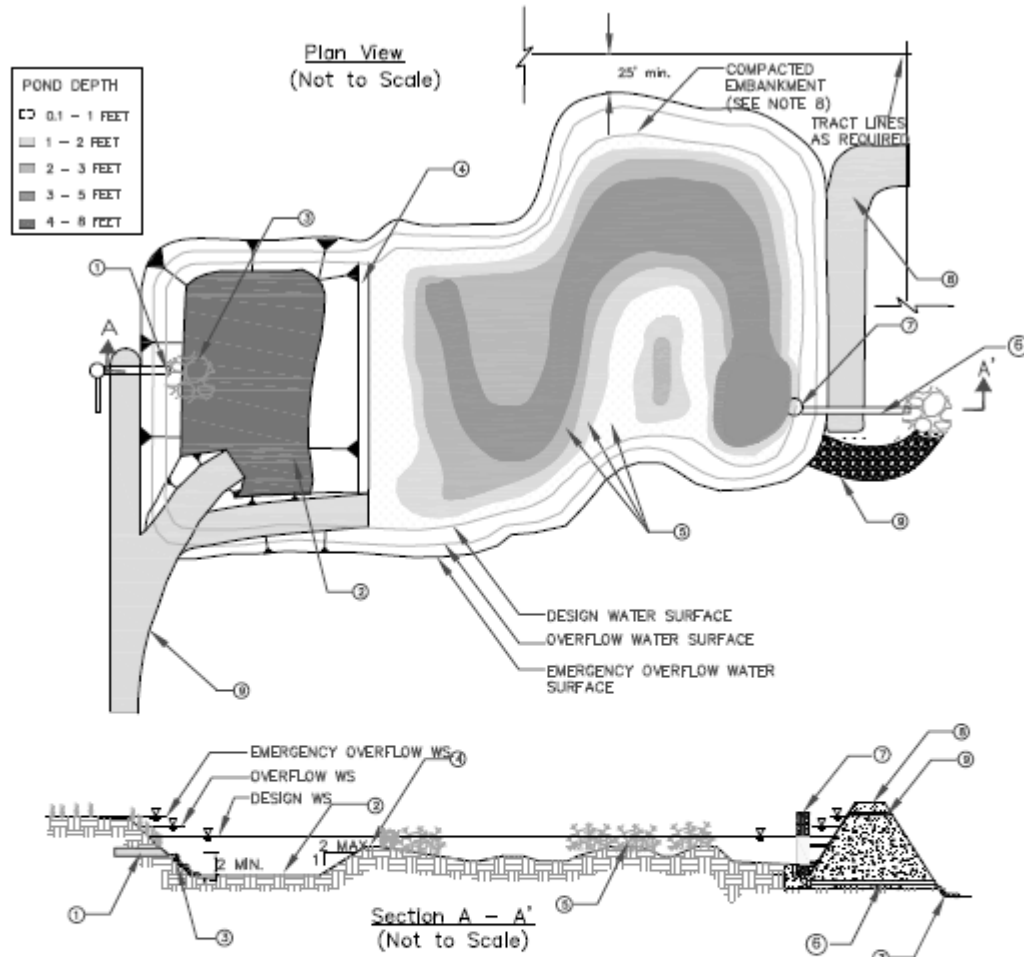

- NOTES:**
- ① INLET PIPE SHOULD BE SUBMERGED WITH A MINIMUM OF 2' DISTANCE FROM THE BOTTOM
 - ② SEDIMENT FOREBAY, FORE BAY VOLUME SHALL EQUAL 10% TO 20% OF TOTAL WETLAND VOLUME. FOREBAY DEPTH SHALL BE 4' MIN TO 8' MAX PLUS AN ADDITIONAL 1' MIN SEDIMENT STORAGE DEPTH.
 - ③ RIPRAP APRON OR OTHER INLET ENERGY DISSIPATION.
 - ④ BERM AT DESIGN WATER SURFACE ELEVATION OR SUBMERGED 1' BELOW DESIGN WATER SURFACE ELEVATION. EXTEND BERM ACROSS ENTIRE WIDTH OF THE WETLAND.
 - ⑤ WETLAND VEGETATION. PLANTING SCHEME MUST BE DESIGNED BY A WETLAND ECOLOGIST.
 - ⑥ EMBANKMENT SIDE SLOPES SHALL BE NO STEEPER THAN 2H:1V OUTSIDE AND 3H:1V INSIDE
 - ⑦ SIZE OUTLET PIPE TO PASS CAPITAL DESIGN PEAK FLOW FOR ONLINE AND WATER QUALITY PEAK FLOW FOR OFFLINE BASINS.
 - ⑧ WATER QUALITY OUTLET STRUCTURE.
 - ⑨ MAINTENANCE RAMP SHOULD BE PAVED. SLOPE SHOULD NOT EXCEED 12%. MAINTENANCE RAMP SHOULD PROVIDE ACCESS TO BOTH THE FOREBAY AND MAIN BASIN.

Figure E-84. Constructed Wetland Schematic

Disadvantages

- Must have a continuous base flow to maintain aquatic plants
- Is dependent on overall imperviousness of tributary area
- May have aesthetic concerns about a facility that looks swampy
- May have public safety concerns if there is public access
- Results in standing water, which may allow vector breeding
- Requires a large footprint
- Has a high initial cost of implementation

General Constraints and Implementation Considerations

- Appropriate land uses include large residential developments and commercial, institutional, and industrial areas where incorporation of a green space and a constructed wetland into the landscape is desirable and feasible.
- Constructed wetlands can be used effectively in combination with upstream stormwater quality control measures such as vegetated swales.
- They require relatively large areas (up to 12 percent of the tributary area) and are usually larger than wet ponds because the average depth is smaller.
- They are most appropriate for sites with low-permeability soils that will support aquatic plant growth. Infiltration through a wetland bottom cannot be relied upon because the bottom is either covered by low permeability soils or the presence of a shallow groundwater table.
- Wetland bottom channels require a near-zero, stable slopes.
- A base flow of water is required to maintain aquatic conditions.
- An impermeable liner may be required to maintain permanent pool level in areas with porous soils.
- Seepage collars may be required on outlet pipes to prevent seepage through embankments.

Design Specifications

The following sections describe the design specifications for constructed wetlands.

Geotechnical

Implementation of a constructed wetlands in areas with high permeability soils (>0.3 in/hr) requires impermeable liners to maintain permanent pools and/or micro-pools in the wetlands. Liners can be either synthetic materials (geomembrane liner) or imported lower permeability soils (i.e., clays). A water balance should be conducted to determine whether a liner is required. The following conditions can be used as a guideline:

T-2: Constructed Wetland

- The sediment forebay must retain at least three feet of water year-round in order for pre-settling to be effective.
- The wetland basin must retain water for at least ten months of the year. Because wetland plants can adapt to periods of summer drought, a limited drought period is allowed in the wetland basin. This may allow for a soil liner rather than a geomembrane liner.

If low permeability soils are used for the liner, a minimum of 18 inches of native soil amended with good topsoil or compost (one part compost mixed with three parts native soil) must be placed over the liner. If a synthetic liner is used, a soil depth of two feet is recommended to prevent damage to the liner during planting.

Pretreatment

If a sediment forebay is used for pretreatment to remove coarse solids, it may be constructed with an internal berm made out of earthen embankment material, grouted riprap, or other structurally-sound material.

- The sediment forebay should have a volume equal to 10 to 20 percent of the total constructed wetland volume.
- The depth of the sediment forebay should be between four and eight feet.
- One foot of sediment storage must be provided in the sediment forebay.
- Permanent steel post depth markers must be placed in the sediment forebay to identify the settled sediment removal limits at 50 and 100 percent of the sediment storage depth.
- A gravity drain outlet from the sediment forebay (minimum four-inch diameter) must extend the entire width of the internal berm.
- The sediment forebay outlet must be off-set from the inflow flow line to prevent short-circuiting.

Geometry

- Constructed wetlands consist of at least two cells including a sediment forebay and a wetland basin. The berm separating the two cells must be uniform in cross-section and shaped such that its downstream side gradually slopes into the main wetland basin. The top of the berm must be either at the mitigation volume water surface or submerged one foot below the mitigation volume water surface. The side slopes of the berm must meet the following specifications:
 - If the top of the berm is at the mitigation volume water surface, the berm side slopes must be no steeper than 3:1 (H:V); or
 - If the top of berm is submerged 1 foot below the mitigation volume water surface, the upstream side slope has a maximum slope of 2:1 (H:V).

T-2: Constructed Wetland

- The side slopes of the constructed wetland must meet the following specifications:
 - The interior side slopes up to the overflow water surface must be no greater than 3:1 (H:V) unless stabilization has been approved by a licensed geotechnical engineer.
 - The exterior side slopes must be no greater than 2:1 (H:V) unless stabilization has been approved by a licensed geotechnical engineer.
 - For any slope (interior or exterior) greater than 2:1 (H:V), a geotechnical report must be submitted and approved by GMED.
- The wetland basin should be designed with a “naturalistic” shape and a range of depths intermixed throughout the wetland basin to a maximum of five feet. See the table below for a recommended depth distribution.

Depth Range (ft)	Percent by Area
0.1 – 1	15%
1 – 3	55%
3 – 5	30%

- The flow path length-to-width ratio should be a minimum of 3:1, but preferably 4:1 or greater. A higher flow path length to width ratio increases fine sediment removal.
- A minimum freeboard of one foot above the maximum water surface elevation must be maintained.
- Wetland pools should be designed with a hydraulic residence time for dry weather flows of less than seven days in order to minimize vector breeding and stagnation issues.
- A minimum 25-foot buffer must be provided around the top perimeter of the constructed wetland.

Embankments

Embankments are earthen slopes or berms used for detaining or redirecting the flow of water. The following criteria apply for embankment design:

- The minimum top width of all berm embankments must be 20 feet, unless otherwise approved by a licensed geotechnical engineer and GMED.
- Berm embankments must be constructed on native consolidated soil or adequately compacted and stable fill soils approved by a licensed geotechnical engineer. Soils must be free of loose surface soil materials, roots, and other organic debris.

- All earthworks must be conducted in accordance with the Standard Specifications for Public Works Construction.
- Berm embankments greater than four feet in height must be constructed by excavating a key equal to 50 percent of the berm embankment cross-sectional height and width. This requirement may be waived if specifically recommended by a licensed geotechnical engineer.
- Berm embankments must be constructed of compacted soil (95 percent minimum dry density, Modified Proctor method per ASTM D1557) and placed in six inch lifts.
- Low growing native or non-invasive perennial grasses must be planted on downstream embankment slopes. See Attachment B of the Vegetation Management on Embankment Dams of Public Works' Debris Control Facilities for a recommended plant list.

Sizing

Constructed wetlands must be designed to capture and retain the SWQDv (see Section 6 for SWQDv calculation procedures). If extended detention is included, then the extended detention volume must provide at least 12 hours detention of 20 percent of the mitigation volume.

Flow Entrance and Energy Dissipation

The inlet to the constructed wetland must be submerged with the inlet pipe invert a minimum of two feet from the bottom (not including sediment storage). The top of the inlet pipe should be submerged at least one foot, if possible. A submerged inlet will dissipate energy from incoming flow. The distance from the bottom is set to minimize resuspension of settled sediments. Alternative inlet designs that accomplish these objectives are acceptable. Energy dissipation controls must also be used at the outlet from the construction wetland unless the wetland discharges to the storm drain system or a hardened channel. Consult with LACDPW for the appropriate type and design of the energy dissipation structure.

Water Supply

A water balance must be conducted to demonstrate that adequate water supply will be present to maintain a permanent pool of water during a drought year when precipitation is 50 percent of average for the site. The water balance must consider evapotranspiration, infiltration, precipitation, spillway discharge, and nuisance flow (where appropriate).

If a water balance indicates that losses will exceed inputs, a source of water must be provided to maintain the water surface elevation throughout the year. The water supply must be of sufficient quantity and quality to not have an adverse impact on the water quality of the constructed wetland.

Vegetation

The wetland basin must be planted with emergent wetland plants based on recommendations from a wetlands specialist.

Outlet Structure and Spillway

An outlet pipe and structure must be provided and sized, at a minimum, to pass flows above the mitigation volume of the SWQDv. The outlet pipe may be a perforated riser strapped to a manhole (see Figure E-16) or placed in an embankment suitable for extended detention or may be back-sloped to a catch basin with a grated opening (jail house window) or manhole with a cone grate (birdcage) (see Figure E-15). The grate or birdcage openings provide an overflow route should the constructed wetland outlet pipe become clogged.

An overflow spillway or an overflow riser must be provided. The overflow device must be designed to pass the maximum storm size diverted to the constructed wetland, with a minimum one-foot freeboard, directly to the downstream conveyance system or another acceptable discharge point. If an overflow spillway potentially discharges to a steep slope, an overflow riser and a spillway must be provided. The overflow spillway must be designed to withstand the energy of the spillway flows (see Figure E-17). The spillway must be armored full width, beginning at a point midway across the berm embankment and extending downstream to where emergency overflows re-enters the conveyance system.

Spillways must meet the California Department of Water Resources, Division of Safety of Dams Guidelines for the Design and Construction of Small Embankment Dams (www.water.ca.gov/damsafety/docs/GuidelinesSmallDams.pdf).

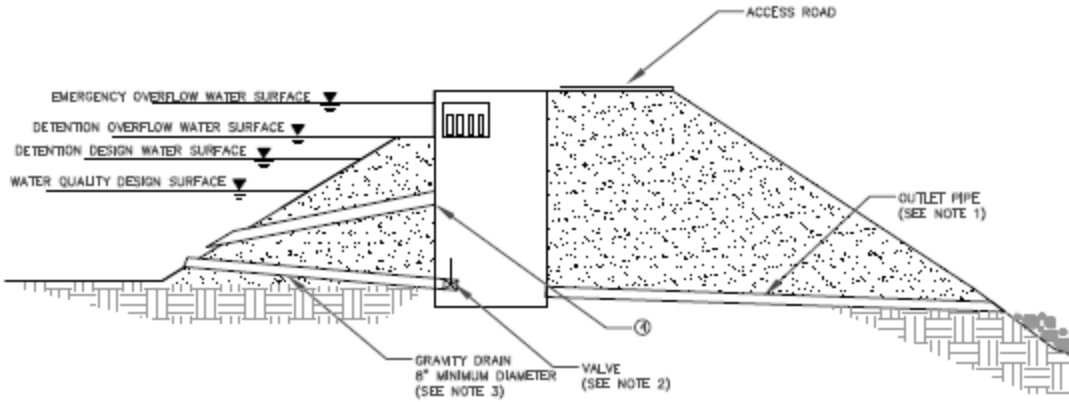

Inverted Pipe Outlet Structure
(Not to Scale)

NOTES:

- ① SIZE OUTLET PIPE SYSTEM TO PASS CAPITAL PEAK FLOW FOR ON-LINE PONDS AND WATER QUALITY PEAK FLOW FOR OFF-LINE PONDS.
- ② VALVE MAY BE LOCATED INSIDE MANHOLE OR OUTSIDE WITH APPROVED OPERATIONAL ACCESS
- ③ INVERT OF DRAIN SHALL BE 6" MINIMUM BELOW TOP OF INTERNAL BERM. LOWER PLACEMENT IS DESIRABLE. INVERT SHALL BE 6" MINIMUM ABOVE BOTTOM OF POND.
- ④ OUTLET PIPE INVERT SHALL BE AT WETPOOL WATER SURFACE ELEVATION

Figure E-95. Inverted Pipe Outlet Schematic

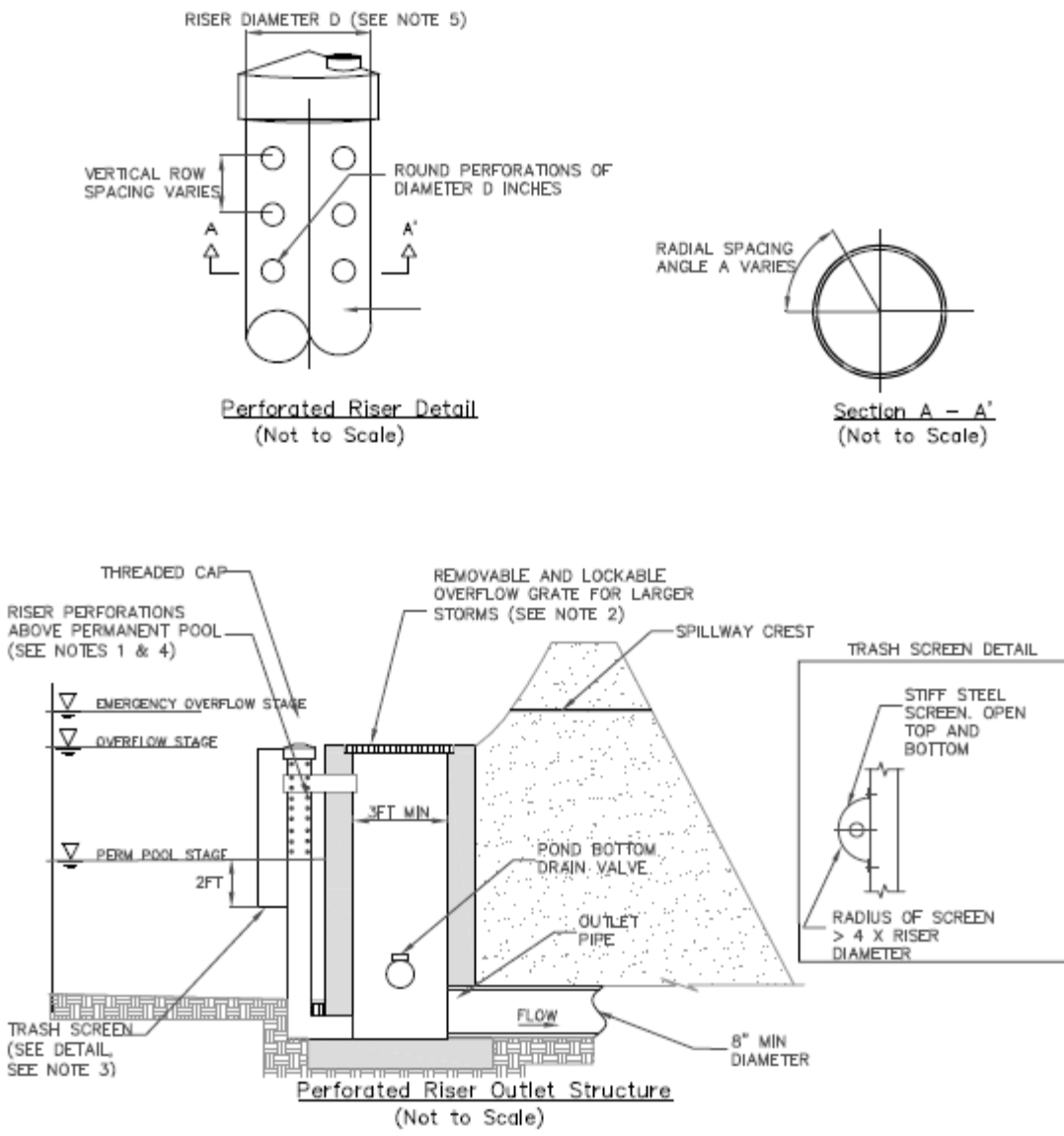

- NOTES:**
- ① RISER PIPE SHALL BE SIZED TO PROVIDE 36 TO 48-HOUR FULL BRIM DRAW DOWN TIME.
 - ② TOTAL OUTLET CAPACITY: CAPITAL DEVELOPED PEAK FLOW FOR ON-LINE BASINS AND WATER QUALITY DESIGN FLOW FOR OFF-LINE BASINS.
 - ③ SCREEN OPENINGS SHALL BE AT LEAST 1/8" AND SHALL NOT EXCEED THE DIAMETER OF THE PERFORATIONS ON THE RISER.
 - ④ RISER PIPE PERFORATION DIAMETER SHALL BE NO LESS THAN 1/8" AND NO MORE THAN 2"
 - ⑤ MINIMUM PIPE DIAMETER (D) IS 2'
 - ⑥ RISER PIPE MATERIAL IS CMP

Figure E-106. Riser Outlet Schematic

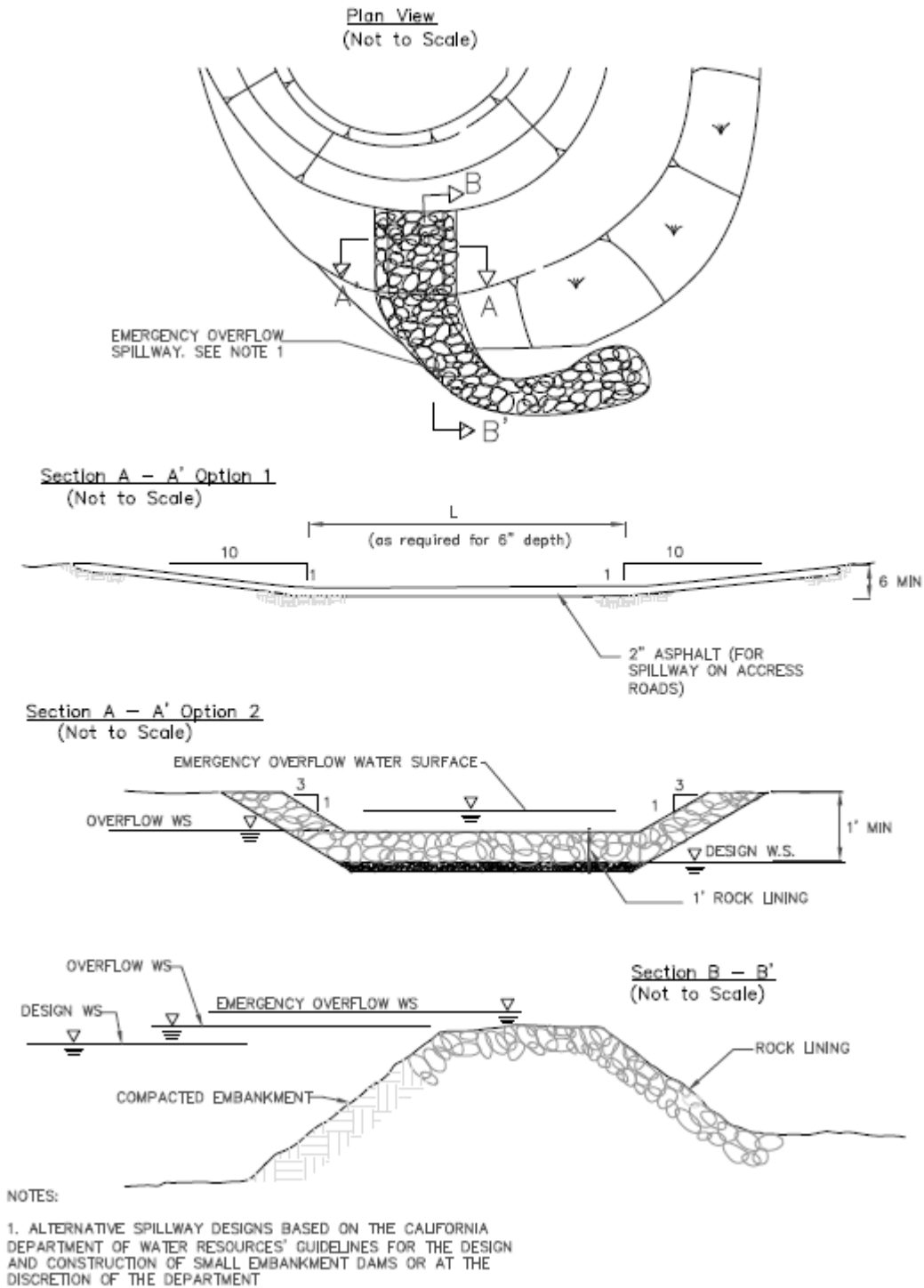

Figure E-17. Spillway Design Schematic

Exterior Landscaping

Landscaping outside of the constructed wetland, but within the easement/right-of-way, is required and must adhere to the following specifications such that it will not hinder maintenance operations:

- No trees or shrubs may be planted within ten feet of inlet or outlet pipes or manmade drainage structures such as spillways, flow spreaders, or earthen embankments. Species with roots that seek water, such as willow or poplar, shall not be used within 50 feet of pipes or manmade structures.
- Prohibited non-native plant species will not be permitted.
- Other resources for identifying suitable plant types can be found by consulting a nursery, arborist, landscape architect, or referring to online resources such as:
 - Calflora (<http://calflora.org>), which is a database of wild California plants that include plant characteristics and photos.
 - Los Angeles River Master Plan Landscaping Guidelines and Plant Palettes (http://ladpw.org/wmd/watershed/LA/LAR_planting_guidelines_webversion.pdf), which is a guidance document providing a listing of native plant communities in the Los Angeles area.
 - The Jepson Online Interchange California Floristics (<http://ucjeps.berkeley.edu/interchange.html>), which is a database that provides information on identification, taxonomy, distribution, ecology, relationships, and diversity of California vascular plants.
 - VegSpec (<http://catalog.data.gov/dataset/vegspec>), which is a web-based decision support system that assists land managers in the planning and design with vegetative establishment practices.
 - United States Department of Agriculture (<http://plants.usda.gov/java>), which is an extensive database of native and non-native plants of the United States with over 100 plant characteristics.

Fencing

Safety is provided by fencing of the stormwater quality control measure. Fences shall be designed and constructed in accordance with Title 11, Section 11.48 of the Los Angeles County Code and must be located at or above the top of overflow structure elevation. Shrubs (LACDPW-approved, California-adapted species) may be used to conceal the fencing.

Maintenance Access

Maintenance access must be provided to the drainage structures associated with the constructed wetland (e.g., inlet, overflow or bypass devices) if it is publicly-maintained. Manhole and catch basin lids must be in or at the edge of the access road. An access

ramp to the constructed wetland bottom is required to facilitate the entry of sediment removal and vegetation maintenance equipment.

Access roads must meet the following design specifications:

- All access ramps and roads must be paved with a minimum of six inches concrete over three inches of crushed aggregate base material. This requirement may be modified depending on the soil conditions and intended use of the road at the discretion of LACDPW.
- The maximum grade is 12 percent unless otherwise approved by LACDPW.
- Centerline turning radius must be a minimum of 40 feet.
- Access roads less than 500 feet long must have 12-foot wide pavement within a minimum 15-foot wide bench. Access roads greater than 500 feet long shall have 16-foot wide pavement within a minimum 20-foot wide bench.
- All access roads must terminate with turnaround areas of 40-feet by 40-feet. A hammer type turn around area or a circle drive around the top of the constructed wetland is also acceptable.
- Adequate double-drive gates and commercial driveways are required at street crossings. Gates should be located a minimum of 25 feet from the street curb except in residential areas where the gates may be located along the property line provided there is adequate sight distance to see oncoming vehicles at the posted speed limit.

Restricted Construction Materials

The use of pressure-treated wood or galvanized metal at or around a constructed wetland is prohibited. The use of galvanized fencing is permitted if in accordance with the Fencing requirement above.

Maintenance Requirements

Maintenance and regular inspections are important for proper function of constructed wetlands. The following are general maintenance requirements:

- Inspect the constructed wetland annually. Inspections after major storm events are encouraged. Remove trash and debris, as needed, but at least annually prior to the beginning of the wet season.
- Maintain site vegetation as frequently as necessary to maintain the aesthetic appearance of the site and to prevent clogging of outlets, creation of dead spaces, and barriers to mosquito fish to access pooled areas, and as follows:
 - Prune and/or remove vegetation, large shrubs, or trees that limit access or interfere with operation of the constructed wetlands.
 - Re-vegetate slope areas that have become bare. Re-grade eroded areas prior to re-vegetating.

T-2: Constructed Wetland

- Remove and replace invasive vegetation with native vegetation. Invasive species should never contribute more than 25 percent of the vegetated area. For more information on invasive weeds, including biology and control of listed weeds, look at the “encycloweedia” located at the California Department of Food and Agriculture website (http://www.cdfa.ca.gov/plant/ipc/encycloweedia/encycloweedia_hp.htm) or the California Invasive Plant Council website (www.cal-ipc.org).
- Remove dead vegetation if it exceeds 10 percent of area coverage. Replace vegetation immediately to maintain cover density and control erosion where soils are exposed.
- Do not use herbicides or other chemicals to control vegetation.
- Remove sediment buildup exceeding 50 percent of the sediment storage capacity, as indicated by the steel markers, in the sediment forebay. Test removed sediments for toxic substance accumulation in compliance with current disposal requirements if visual or olfactory indications of pollution are noticed. If toxic substances are detected at concentrations exceeding thresholds of Title 22, Section 66261 of the California Code of Regulations, dispose of the sediment in a hazardous waste landfill and investigate and mitigate the source of the contaminated sediments to the maximum extent possible.
- Re-establish vegetation, which may require replanting and/or reseeding, following sediment removal activities.

A summary of potential problems that may need to be addressed by maintenance activities is presented in Table E-26.

The County requires execution of a maintenance agreement to be recorded by the property owner for the on-going maintenance of any privately-maintained stormwater quality control measures. The property owner is responsible for compliance with the maintenance agreement. A sample maintenance agreement is presented in Appendix H.

T-2: Constructed Wetland

Table E-26. Constructed Wetland Troubleshooting Summary

Problem	Conditions When Maintenance Is Needed	Maintenance Required
Trash and Debris	Trash and debris > 5 ft ³ /1,000 ft ² If less than threshold all trash and debris will be removed as part of next scheduled maintenance.	Remove and dispose of trash and debris.
Contaminants and Pollution	Any evidence of oil, gasoline, contaminants, or other pollutants	Remove any evidence of visual contamination. Dispose of materials contaminated with petroleum hydrocarbons in accordance with applicable laws.
Vegetation	Overgrown vegetation	Mow and trim vegetation to prevent establishment of woody vegetation, and for aesthetics and vector control reasons.
	Presence of invasive, poisonous, nuisance, or noxious vegetation or weeds	Remove this vegetation.
	Algae mats covering more than 20 percent of surface	Remove algae mats.
Sediment Accumulation	Accumulation of sediment, debris, and oil/grease in forebay, pretreatment devices, surface, inlet, or overflow structures	Remove sediment when accumulation reaches 10 percent of original design depth or if resuspension is observed. (Note: Sediment removal may not be required in the wetland basin for as long as 20 years.) Re-grade if necessary.
Erosion	Undercut or eroded areas at inlet structures Animal burrows present	Repair eroded areas and re-grade if necessary.
Water Drainage Rate	Infiltrating water	Repair or replace liner if necessary to maintain a permanent pool.

T-3: Extended Detention Basin

Description

Extended detention basins are permanent basins formed by excavation and/or construction of embankments to temporarily detain stormwater runoff to allow for settling of sediment particles before the stormwater runoff is discharged. An extended detention basin reduces peak stormwater flow rates, provides stormwater runoff treatment, and can provide hydromodification control.



Extended detention basins are designed to drain completely between storm events over a specified period of time. The slopes, bottom, and forebay of extended detention basins are typically vegetated.

During storm events that exceed the design capacity, stormwater runoff will pass through the extended detention basin and discharge over a primary overflow outlet untreated, or during extreme events, over a spillway. Stormwater runoff enters a sediment forebay where coarse solids are removed prior to flowing into the main cell of the basin where finer sediment and associated pollutants settle as stormwater is detained and slowly released through a controlled outlet structure.

A schematic of a typical extended detention basin is presented in Figure E-18.

LID Ordinance Requirements

Extended detention basins can be used as a stormwater quality control measure to treat stormwater runoff for the following alternative compliance measures:

- Off-site infiltration;
- Groundwater replenishment projects; and
- Off-site retrofit of existing development.

The project applicant must ensure that all pollutants of concern are addressed when using an extended detention basin (see Section 7.4). The following table identifies the pollutants of concern that are treated to the water quality benchmark (see Table 7-2 of the LID Standards Manual) by an extended detention basin:

T-3: Extended Detention Basin

Pollutant of Concern	Treated by Extended Detention Basin?
Suspended solids	No
Total phosphorus	No
Total nitrogen	No
Total Kjeldahl nitrogen	No
Cadmium, total	No
Chromium, total	No
Copper, total	Yes
Lead, total	No
Zinc, total	No

Source: Treatment Best Management Practices Performance, Los Angeles Regional Water Quality Control Board, December 9, 2013.

Advantages

- Is relatively easy and inexpensive to build and operate due to its simple design
- Is useful in retrofit situations where low hydraulic head requirements allow basins to be sited within the constraints of the existing storm drain system

Disadvantages

- May pose a risk to cold water receiving waters because water retained in the permanent pool is typically heated over time
- May adversely affect property value of nearby property due to the aesthetics of dry, bare areas, and exposure of inlet and outlet structures
- Can mitigate adverse effects with appropriate vegetation selection and maintenance

T-3: Extended Detention Basin

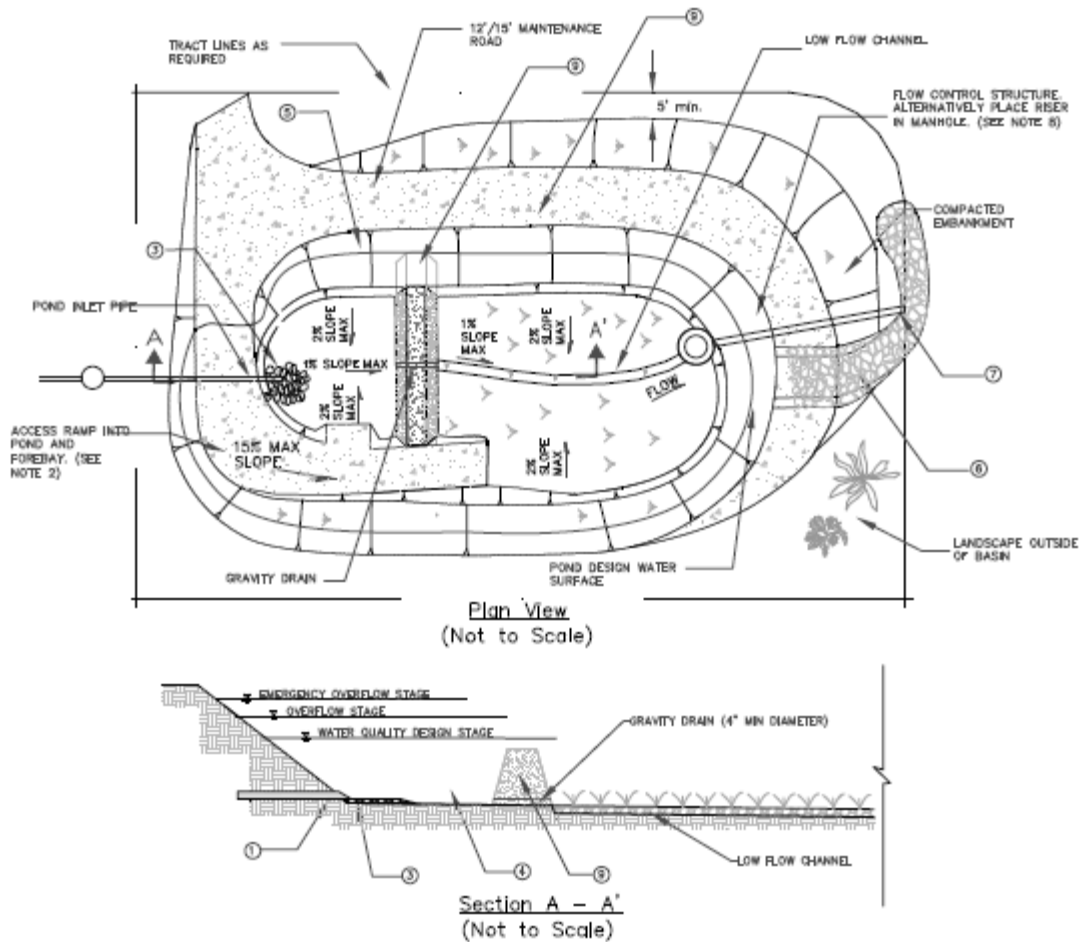

- NOTES:**
- ① INLET PIPE SHALL BE DESIGNED AND LOCATED SO THAT NON-EROSIVE VELOCITIES OCCUR IN THE FOREBAY
 - ② MAINTENANCE RAMP SHOULD BE PAVED. SLOPE SHOULD NOT EXCEED 12%. MAINTENANCE RAMP SHOULD PROVIDE ACCESS TO BOTH THE FOREBAY AND MAIN BASIN.
 - ③ RIP RAP APRON OR OTHER INLET ENERGY DISSIPATION SHALL BE PROVIDED SUCH THAT VELOCITIES IN THE FOREBAY ARE < 4 FT/S.
 - ④ SEDIMENT FOREBAY SHOULD BE SIZED TO PROVIDE 25% OF THE TOTAL BASIN VOLUME.
 - ⑤ SIDE SLOPES SHOULD NOT EXCEED 3:1 UNLESS APPROVED BY AN ENGINEER. SIDE SLOPES SHALL NOT EXCEED 2:1 WITHOUT A SUPPORTING GEOTECHNICAL REPORT.
 - ⑥ EMERGENCY SPILLWAY MUST BE SIZED TO PASS CAPITAL DEVELOPMENT PEAK FLOW FOR ON-LINE BASINS, AND WATER QUALITY DESIGN FLOW FOR OFF-LINE BASINS.
 - ⑦ OUTLET PIPE, ENERGY DISSIPATION SHALL BE PROVIDED UNLESS DISCHARGE IS TO PIPE OR HARDENED CHANNEL
 - ⑧ OUTLET STRUCTURE SHOULD BE SIZED TO DRAIN WATER QUALITY VOLUME IN 36 - 48 HOURS (SEE FIGURE 2-2 FOR PERFORATED RISER DETAILS). ALTERNATIVELY PLACE RISER STRUCTURE IN A MANHOLE (SEE FIGURE 2-3).
 - ⑨ INSTALL EARTHEN BERM OR EQUIVALENT. TOP OF BERM SHALL BE 2' MINIMUM BELOW DESIGN WATER QUALITY STAGE. BERM SHALL BE KEYED INTO EMBANKMENT A MINIMUM OF 1' ON BOTH SIDES.

Figure E-18. Extended Detention Basin Schematic

General Constraints and Implementation Considerations

- If constructed early in the land development cycle, extended detention basins can serve as sediment traps during construction within the tributary area.
- Surface basins are typical, but underground vaults may be appropriate in a small commercial development.
- Small- to medium-sized tributary areas with available open space and drainage areas greater than five acres are typical drainage area sizes.
- Approximately 0.5 to 2 percent of the tributary development area is the required area needed for an extended detention basin.
- Extended detention basins should be located in areas where the bottom of the basin is at least two feet higher than the seasonal high groundwater level as determined according to the most recent GMED Policy GS 200.1.
- Extended detention basins can be used with almost all soils and geology with minor adjustments for regions with rapidly percolating soils. In these areas, impermeable liners can be installed to prevent groundwater contamination.
- Extended detention basins placed above slopes greater than 15 percent or within 200 feet from the top of a hazardous slope or landslide area require a geotechnical investigation.
- Seepage collars may need to be installed on outlet pipes to prevent seepage through embankments.
- The areas used for extended detention basins should be clearly marked before site work begins to avoid soil disturbance and compaction during construction.

Design Specifications

The following sections describe the design specifications for extended detention basins.

Geotechnical

Extended detention basins can be used with almost all soils and geology with minor design adjustments for rapidly draining soils (sandy or gravelly soils with infiltration rate greater than 2.4 in/hr). If rapidly percolating soils are present, extended detention basins should be designed by a licensed geotechnical engineer to include lower permeability soils in the subgrade to prevent rapid, untreated infiltration.

The slopes of the extended detention basin must be analyzed for slope stability using rapid drawdown conditions and must meet minimum County standards. A static safety factor of 1.5 must be used. Seismic analysis is not required due to the temporary inundation condition.

Pretreatment

If a sediment forebay is used for pretreatment to remove coarse solids, it may be constructed with an internal berm made out of earthen embankment material, grouted riprap, or other structurally-sound material.

- The sediment forebay must have a volume equal to 25 percent of the total extended detention basin volume.
- Permanent steel post depth markers must be placed in the sediment forebay to identify the settled sediment removal limits at 50 and 100 percent of the sediment storage depth.
- A gravity drain outlet from the sediment forebay (minimum four-inch diameter) must extend the entire width of the internal berm.
- The sediment forebay outlet must be off-set from the inflow flow line to prevent short-circuiting.

Geometry

- The total extended detention basin volume should be the volume of stormwater runoff that must be mitigated plus an additional five percent for total suspended solids (TSS) accumulation. This basin volume does not include the required freeboard.
- The minimum freeboard must be one foot above the maximum water surface elevation over the spillway.
- To improve TSS removal, the length-to-width ratio at half basin depth must be a minimum of 1.5:1.
- The cross-sectional geometry across the width of the basin should be approximately trapezoidal with a maximum side slope of 3:1 (H:V) unless otherwise permitted by LACDPW.
 - The interior side slopes up to the emergency overflow water surface must be no greater than 3:1 (H:V) unless stabilization has been approved by a licensed geotechnical engineer.
 - The exterior side slopes must be no greater than 2:1 (H:V) unless stabilization has been approved by a licensed geotechnical engineer.
 - For any slope (interior or exterior) greater than 2:1 (H:V), a geotechnical report must be submitted and approved by GMED.
 - Pond walls may be vertical retaining walls provided: (a) they are constructed of reinforced concrete; (b) a fence is provided along the top of the wall (see Fencing below) or further back; and (c) the design is stamped by a licensed civil engineer and approved by LACDPW.
- A low flow channel, which is a narrow, shallow trench filled with pea gravel (or equivalent) that runs the length of the extended detention basin, must be

provided to drain the basin of dry weather flows. Lining the low flow channel with concrete is recommended to prevent erosion. The low flow channel must have a depth of six inches and a width of one foot and tie into the outlet structure.

- The longitudinal slope (direction of flow) in the sediment forebay will be one percent and may range from zero to one percent in the main basin. The bottom of the basin must have a two percent slope toward the low flow channel.

Embankments

Embankments are earthen slopes or berms used for detaining or redirecting the flow of water. The following criteria apply for embankment design:

- The minimum top width of all berm embankments must be 20 feet, unless otherwise approved by a licensed geotechnical engineer and GMED.
- Berm embankments must be constructed on native consolidated soil or adequately compacted and stable fill soils approved by a licensed geotechnical engineer. Soils must be free of loose surface soil materials, roots, and other organic debris.
- All earthworks must be conducted in accordance with the Standard Specifications for Public Works Construction.
- Berm embankments greater than four feet in height must be constructed by excavating a key equal to 50 percent of the berm embankment cross-sectional height and width. This requirement may be waived if specifically recommended by a licensed geotechnical engineer.
- Berm embankments must be constructed of compacted soil (95 percent minimum dry density, Modified Proctor method per ASTM D1557) and placed in six inch lifts.
- Low growing native or non-invasive perennial grasses must be planted on downstream embankment slopes. See Attachment B of the Vegetation Management on Embankment Dams of Public Works' Debris Control Facilities for a recommended plant list.

Sizing

Extended detention basins must be sized to treat the volume of stormwater runoff that must be mitigated (Section 7) within a 96-hour retention time.

Flow Entrance and Energy Dissipation

Energy dissipation controls, constructed of sound materials such as stones, concrete, or proprietary devices that are rated to withstand the energy of the influent stormwater runoff flow, must be installed at the inlet to the sediment forebay. Flow velocity into the sediment forebay must be 4 ft/s or less. Consult with LACDPW for the type and design of energy dissipation structure.

Vegetation

Vegetation provides erosion protection from both wind and water and biofiltration of stormwater runoff. The bottom and slopes of the extended detention basin must be vegetated. A mix of erosion-resistant plant species that effectively bind the soil should be used on the slopes and a diverse selection of plants that thrive under the specific site, climatic, and irrigation conditions should be specified for the basin bottom. The basin bottom should not be planted with trees, shrubs, or other large woody plants that may interfere with maintenance activities. Only native perennial grasses, forbs, or similar vegetation that can be replaced via seeding should be used on the basin bottom.

Non-native plant species are not permitted. For more information on invasive weeds, including biology and control of listed weeds, refer to the “encycloveedia” located at the California Department of Food and Agriculture website (http://www.cdfa.ca.gov/plant/ipc/encycloveedia/encycloveedia_hp.htm) or the California Invasive Plant Council website (www.cal-ipc.org).

Other resources for identifying suitable plant types can be found by consulting a nursery, arborist, landscape architect, or referring to online resources such as:

- Calflora (<http://calflora.org>), which is a database of wild California plants that include plant characteristics and photos.
- Los Angeles River Master Plan Landscaping Guidelines and Plant Palettes (http://ladpw.org/wmd/watershed/LA/LAR_planting_guidelines_webversion.pdf), which is a guidance document providing a listing of native plant communities in the Los Angeles area.
- The Jepson Online Interchange California Floristics (<http://ucjeps.berkeley.edu/interchange.html>), which is a database that provides information on identification, taxonomy, distribution, ecology, relationships, and diversity of California vascular plants.
- VegSpec (<http://catalog.data.gov/dataset/vegspec>), which is a web-based decision support system that assists land managers in the planning and design with vegetative establishment practices.
- United States Department of Agriculture (<http://plants.usda.gov/java>), which is an extensive database of native and non-native plants of the United States with over 100 plant characteristics.

Outlet Structure

The extended detention basins must drain within 96 hours after a storm event. The outlet structure is designed to release the bottom 50 percent of the detention volume (half-full to empty) over 24 to 48 hours and the top 50 percent (full to half-full) in 48 to 96 hours. Detention of low flows, which account for the majority of incoming flows, for longer periods enhances stormwater runoff treatment.

T-3: Extended Detention Basin

A trash rack or gravel pack around perforated risers may be provided to protect outlet orifices from clogging. Trash racks are better suited for use with perforated vertical plates for outlet control and allow easier access to outlet orifices for purposes of inspection and cleaning. Trash racks must be sized to prevent clogging of the primary water quality outlet without restricting the hydraulic capacity of the outlet control orifices.

The two options that can be used for the outlet structure are:

- Uniformly perforated riser structures; and
- Multiple orifice structures (orifice plate).

The primary overflow (typically a riser pipe connected to the outlet works) should be sized to pass the peak flow rate of stormwater runoff volumes exceeding the mitigation volume. The primary overflow is intended to protect against overtopping or breaching of the extended detention basin embankment. The outlet structure can be placed in the extended detention basin with a debris screen (see Figure E-19) or housed in a standard manhole (see Figure E-20).

Uniformly Perforated Riser Outlet Sizing Methodology (Figure E-19 Figure E-)

The following characteristics influence the perforated riser outlet sizing:

- Shape of the extended detention basin (i.e., trapezoidal);
- Depth and volume of the extended detention basin;
- Elevation and depth of first row of holes;
- Elevation and depth of last row of holes;
- Size of holes;
- Number of rows and number of holes per row; and
- Desired drawdown time (e.g., 24 hour and 72 hour drawdown for top half and bottom half, respectively, and a total drawdown time of 96 hours).

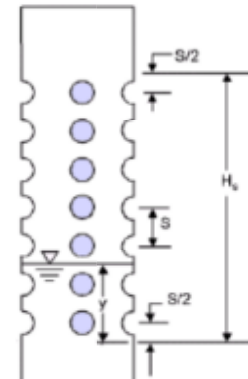

The rate of discharge from a perforated riser structure with uniform holes at equal spacing can be calculated using the following:

$$Q = C_p \times \frac{2 \times A_p}{3 \times H_s} \times \sqrt{2 \times g} \times H^{3/2}$$

Where:

Q = Riser discharge rate [ft³/s];
C_p = Discharge coefficient for perforations (use 0.61);
A_p = Cross-sectional area of all the holes [ft²];
H_s = Distance from s/2 below the lowest row of holes to s/2 above the top row of holes (McEnroe 1988) [ft];
s = Center to center vertical spacing between perforations [ft];
g = Acceleration due to gravity (use 32.2 ft/s); and
H = Effective head on the orifice (measured from the center of orifice to water surface) [ft].

For the iterative computations needed to size the holes in the riser and determine the riser height, a simplified version of the equation above may be used, as shown below:

$$Q = k \times H^{3/2}$$

Where:

$$k = C_p \times \frac{2 \times A_p}{3 \times H_s} \times \sqrt{2 \times g}$$

Uniformly perforated riser designs are defined by the depth or elevation of the first row of perforations, the length of the perforated section of pipe, and the size or diameter of each perforation.

Multiple Orifice (Non-Uniform Outlet Sizing Methodology (Figure E-20))

The following characteristics influence the multiple orifice outlet sizing:

- Shape of the extended detention basin (i.e., trapezoidal);
- Depth and volume of the extended detention basin;
- Elevation of each orifice; and
- Desired drawdown time (e.g., 24 hour and 72 hour drawdown for top half and bottom half, respectively, and a total drawdown time of 96 hours).

The rate of discharge from a single orifice can be calculated using the following equation:

$$Q = C \times A \times (2 \times g \times H)^{0.5}$$

Where:

- Q = Orifice discharge rate [ft³/s];
- C = Discharge coefficient;
- A = Cross-sectional area of orifice or pipe [ft²];
- g = Acceleration due to gravity (use 32.2 ft/s);
- H = Effective head on the orifice (measured from the center of orifice to water surface) [ft].

Multiple orifice designs are defined by the depth (or elevation) and the size (or diameter) of each orifice.

Overflow Structure and Spillway

An overflow spillway or overflow riser must be provided. The overflow device must be designed to pass the maximum storm size diverted to the extended detention basin, with a minimum one-foot freeboard, directly to the downstream conveyance system or another acceptable discharge point. If an overflow spillway potentially discharges to a steep slope, an overflow riser and a spillway must be provided. The emergency overflow spillway must be designed to withstand the energy of the spillway flows (see Figure E-). The spillway must be constructed of grouted riprap.

Spillways must meet the California Department of Water Resources, Division of Safety of Dams *Guidelines for the Design and Construction of Small Embankment Dams* (www.water.ca.gov/damsafety/docs/GuidelinesSmallDams.pdf).

Exterior Landscaping

Landscaping outside of the extended detention basin, but within the easement/right-of-way, is required and must adhere to the following specifications such that it will not hinder maintenance operations:

- No trees or shrubs may be planted within ten feet of inlet or outlet pipes or manmade drainage structures such as spillways, flow spreaders, or earthen embankments. Species with roots that seek water, such as willow or poplar, shall not be used within 50 feet of pipes or manmade structures.
- Prohibited non-native plant species will not be permitted.
- Other resources for identifying suitable plant types can be found by consulting a nursery, arborist, landscape architect, or referring to online resources such as:
 - Calflora (<http://calflora.org>), which is a database of wild California plants that include plant characteristics and photos.
 - Los Angeles River Master Plan Landscaping Guidelines and Plant Palettes (http://ladpw.org/wmd/watershed/LA/LAR_planting_guidelines_webversion.pdf), which is a guidance document providing a listing of native plant communities in the Los Angeles area.

- The Jepson Online Interchange California Floristics (<http://ucjeps.berkeley.edu/interchange.html>), which is a database that provides information on identification, taxonomy, distribution, ecology, relationships, and diversity of California vascular plants.
- VegSpec (<http://catalog.data.gov/dataset/vegspec>), which is a web-based decision support system that assists land managers in the planning and design with vegetative establishment practices.
- United States Department of Agriculture (<http://plants.usda.gov/java>), which is an extensive database of native and non-native plants of the United States with over 100 plant characteristics.

Fencing

Safety is provided by fencing of the stormwater quality control measure. Fences shall be designed and constructed in accordance with Title 11, Section 11.48 of the Los Angeles County Code and must be located at or above the top of overflow structure elevation. Shrubs (LACDPW-approved, California-adapted species) may be used to conceal the fencing.

Restricted Construction Materials

The use of pressure-treated wood or galvanized metal at or around an extended detention basin is prohibited. The use of galvanized fencing is permitted if in accordance with the Fencing requirement above.

Maintenance Access

Maintenance access must be provided to the drainage structures associated with the extended detention basin (e.g., inlet, overflow or bypass devices) if it is publicly-maintained. Manhole and catch basin lids must be in or at the edge of the access road. An access ramp to the extended detention basin bottom is required to facilitate the entry of sediment removal and vegetation maintenance equipment.

Access roads must meet the following design specifications:

- All access ramps and roads must be paved with a minimum of six inches concrete over three inches of crushed aggregate base material. This requirement may be modified depending on the soil conditions and intended use of the road at the discretion of LACDPW.
- The maximum grade is 12 percent unless otherwise approved by LACDPW.
- Centerline turning radius must be a minimum of 40 feet.
- Access roads less than 500 feet long must have 12-foot wide pavement within a minimum 15-foot wide bench. Access roads greater than 500 feet long must have 16-foot wide pavement within a minimum 20-foot wide bench.

T-3: Extended Detention Basin

- All access roads must terminate with turnaround areas of 40-feet by 40-feet. A hammer type turn around area or a circle drive around the top of the extended detention basin is also acceptable.
- Adequate double-drive gates and commercial driveways are required at street crossings. Gates should be located a minimum of 25 feet from the street curb except in residential areas where the gates may be located along the property line provided there is adequate sight distance to see oncoming vehicles at the posted speed limit.

Maintenance Requirements

Maintenance and regular inspections are important for proper function of extended detention basins. The following are general maintenance requirements:

- Inspect the extended detention basin annually. Inspections after major storm events are encouraged. Remove trash and debris, as needed, but at least annually prior to the beginning of the wet season.
- Maintain site vegetation as frequently as necessary to maintain the aesthetic appearance of the site and to prevent clogging of outlets as follows:
 - Prune and/or remove vegetation, large shrubs, or trees that limit access or interfere with operation of the extended detention basin.
 - Re-vegetate slope areas that have become bare. Re-grade eroded areas prior to re-vegetating.
 - Mow grass to four to nine inches high and remove grass clippings.
 - Rake and remove fallen leaves and debris from deciduous plant foliage.
 - Remove and replace invasive vegetation with native vegetation. Invasive species should never contribute more than 25 percent of the vegetated area. For more information on invasive weeds, including biology and control of listed weeds, look at the “encycloveedia” located at the California Department of Food and Agriculture website (http://www.cdfa.ca.gov/plant/ipc/encycloveedia/encycloveedia_hp.htm) or the California Invasive Plant Council website (www.cal-ipc.org).
 - Remove dead vegetation if it exceeds 10 percent of area coverage. Replace vegetation immediately to maintain cover density and control erosion where soils are exposed.
 - Do not use herbicides or other chemicals to control vegetation.
- Remove sediment accumulation exceeding 50 percent of the sediment storage capacity in the sediment forebay, as indicated on the permanent steel post depth markers. Remove sediment from the remainder of the basin when six inches of sediment accumulates. Test removed sediments for toxic substance accumulation in compliance with current disposal requirements if visual or olfactory indications of pollution are noticed. If toxic substances are detected at

T-3: Extended Detention Basin

concentrations exceeding thresholds of Title 22, Section 66261 of the California Code of Regulations, dispose of the sediment in a hazardous waste landfill and investigate and mitigate the source of the contaminated sediments to the maximum extent possible.

- Re-establish vegetation, which may require replanting and/or reseeding, following sediment removal activities.

A summary of potential problems that may need to be addressed by maintenance activities is presented in Table E-27.

The County requires execution of a maintenance agreement to be recorded by the property owner for the on-going maintenance of any privately-maintained stormwater quality control measures. The property owner is responsible for compliance with the maintenance agreement. A sample maintenance agreement is presented in Appendix H.

T-3: Extended Detention Basin

Table E-27. Extended Detention Basin Troubleshooting Summary

Problem	Conditions When Maintenance Is Needed	Maintenance Required
Trash and Debris	Trash and debris > 5 ft ³ /1,000 ft ² If less than threshold all trash and debris will be removed as part of next scheduled maintenance.	Remove and dispose of trash and debris.
Contaminants and Pollution	Any evidence of oil, gasoline, contaminants, or other pollutants	Remove any evidence of visual contamination. Dispose of materials contaminated with petroleum hydrocarbons in accordance with applicable laws.
Vegetation	Overgrown vegetation	Mow and trim vegetation to prevent establishment of woody vegetation, and for aesthetics and vector control reasons.
	Presence of invasive, poisonous, nuisance, or noxious vegetation or weeds	Remove this vegetation.
Sediment Accumulation	Accumulation of sediment, debris, and oil/grease in forebay, pretreatment devices, surface, inlet, or overflow structures	Remove sediment when accumulation reaches 50 percent of original design depth in the forebay. Remove sediment when accumulation reaches six inches in the main basin. Re-grade if necessary.
Erosion	Rilling over two inches deep where cause of damage is still present or where there is potential for continued erosion Erosion observed on a compacted berm embankment	Stabilize slopes. Repair eroded areas and re-grade if necessary.
	Erosion on spillway	Restore rocks and pad depth to design standards.
Settling of Berm	Settlement of berm present	Consult geotechnical engineer to investigate cause. Build berm back up to design elevation.
Piping through Berm	Discernible water flow through berm On-going erosion with potential for erosion to continue	Consult geotechnical engineer to investigate cause. Remove piping. Stabilize berm.
Animal Burrows	Animal burrows present	Fill burrows.
Water Drainage Rate	Low flow channel not draining	Re-grade low flow channel to eliminate standing water.

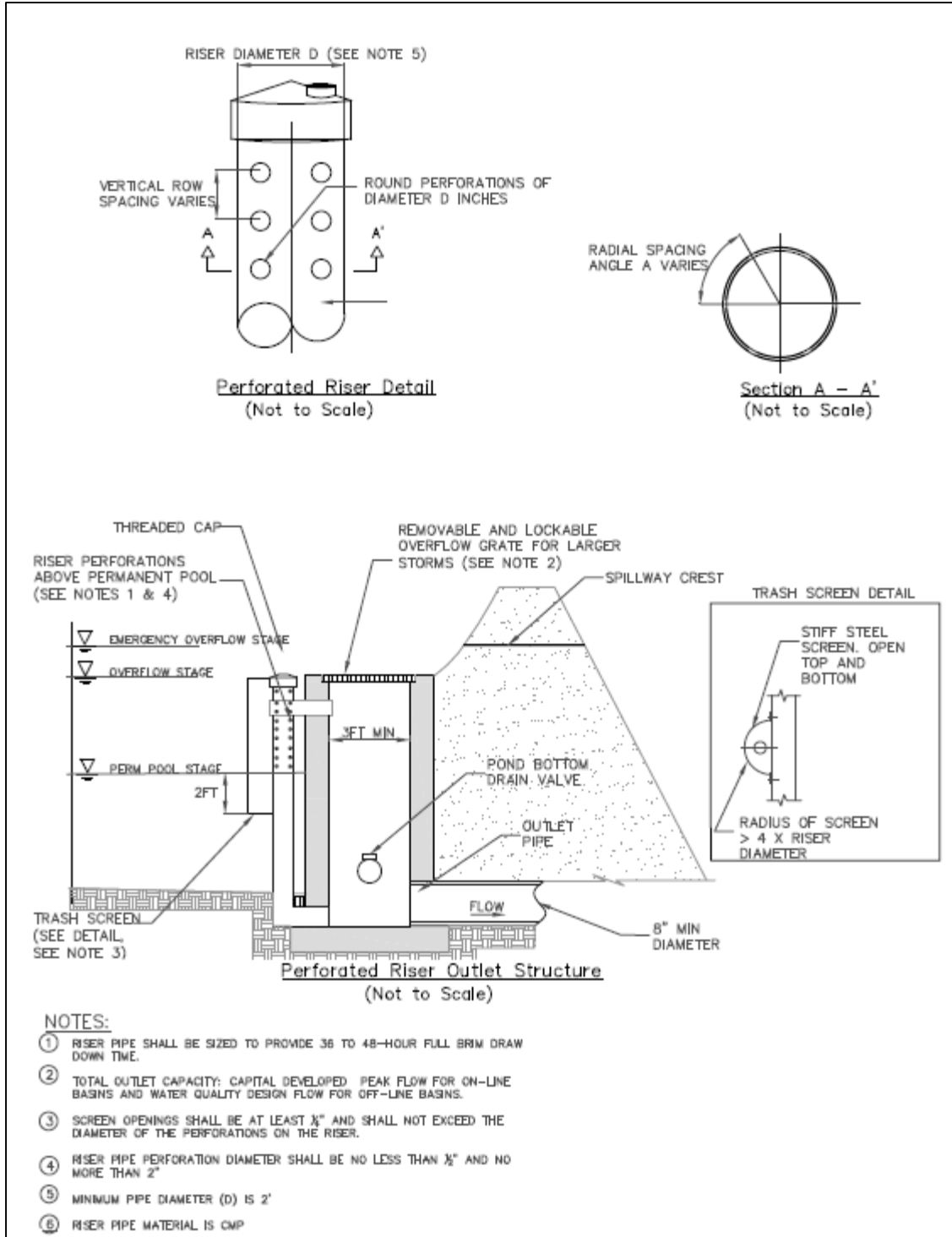

Figure E-19. Perforated Riser Structure

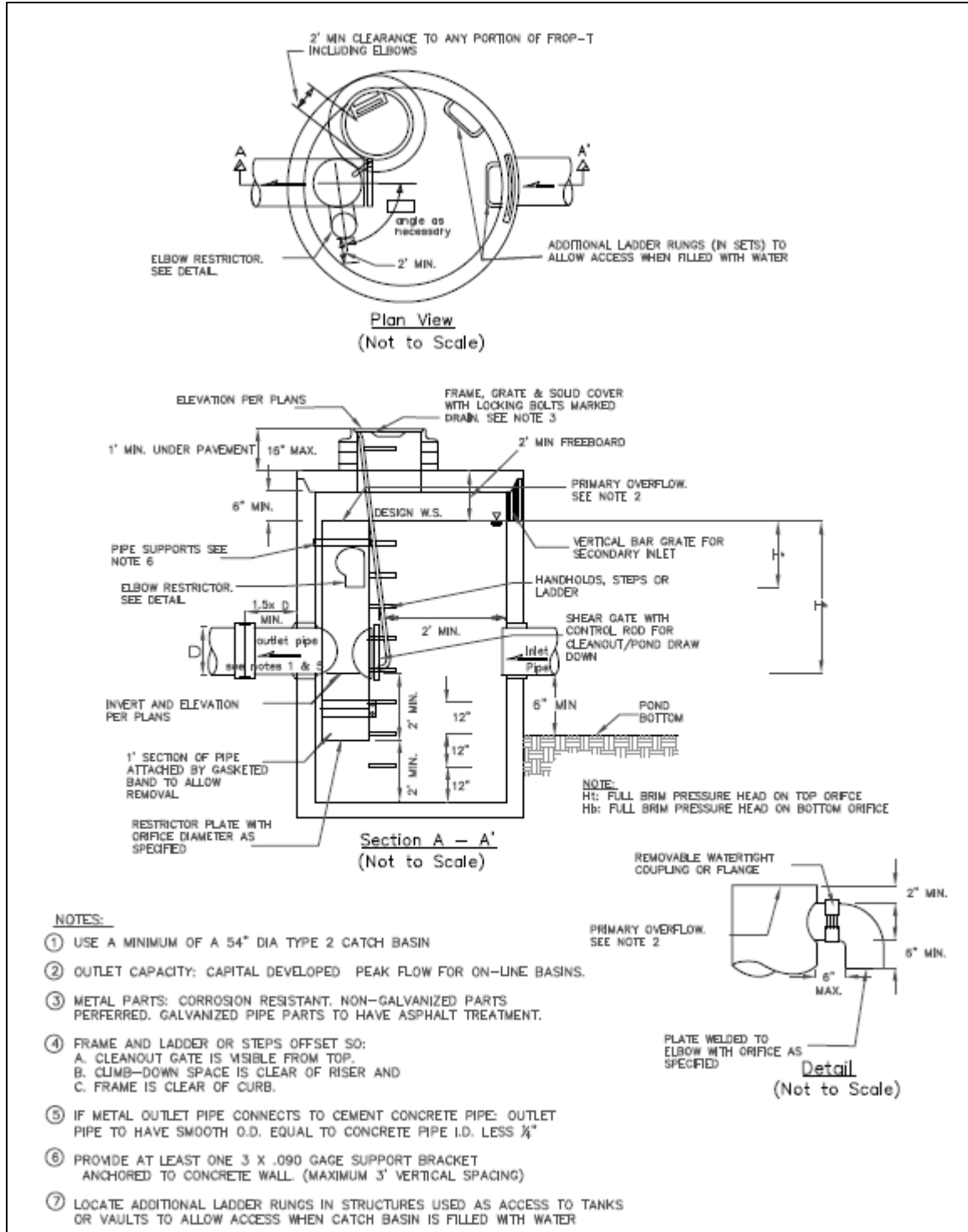

Figure E-2011. Multiple Orifice Outlet

T-4: Wet Pond



Description

Wet ponds are open earthen basins that feature a permanent pool of water that is displaced by stormwater runoff, in part or in total, during storm events. Like extended detention basins, wet ponds are designed to temporarily retain stormwater runoff and slowly release this volume over a design retention period. Wet ponds differ from extended detention basins in that influent stormwater runoff mixes with

and displaces the permanent pool as it enters the basin. Wet ponds differ from constructed wetlands because wet ponds have a greater average depth. A dry weather base flow is required to maintain a permanent pool in the wet pond. The primary treatment mechanism is sedimentation as stormwater runoff resides in this pool, but pollutant removal, particularly nutrients, also occurs through biological activity in the wet pond.

A schematic of a typical wet pond is presented in Figure E-21.

LID Ordinance Requirements

Wet ponds can be used as a stormwater quality control measure to treat stormwater runoff for the following alternative compliance measures:

- Off-site infiltration;
- Groundwater replenishment projects; and
- Off-site retrofit of existing development.

The project applicant must ensure that all pollutants of concern are addressed when using a wet pond (see Section 7.4). The following table identifies the pollutants of concern that are treated to the water quality benchmark (see Table 7-2 of the LID Standards Manual) by a wet pond:

Pollutant of Concern	Treated by Wet Pond?
Suspended solids	Yes
Total phosphorus	Yes
Total nitrogen	Yes
Total Kjeldahl nitrogen	No
Cadmium, total	Yes
Chromium, total	Yes
Copper, total	Yes
Lead, total	No
Zinc, total	Yes

Source: Treatment Best Management Practices Performance, Los Angeles Regional Water Quality Control Board, December 9, 2013.

Advantages

- Can be designed to provide other benefits such as recreation, wildlife habitat, and open space
- Viewed as a public amenity when integrated into a park or open-space setting.
- Can provide water quality improvement for pollutants including dissolved nutrients
- Can serve essentially any size tributary area
- Can provide hydromodification control

Disadvantages

- May have public safety concerns if there is public access
- Results in standing water, which may allow vector breeding
- Must have a base flow or supplemental water to maintain water level
- Requires a large footprint
- May pose a risk to cold water receiving waters because water retained in the permanent pool is typically heated over time
- May have potential issues with algae growth
- May require approval from the California Division of Safety of Dams.

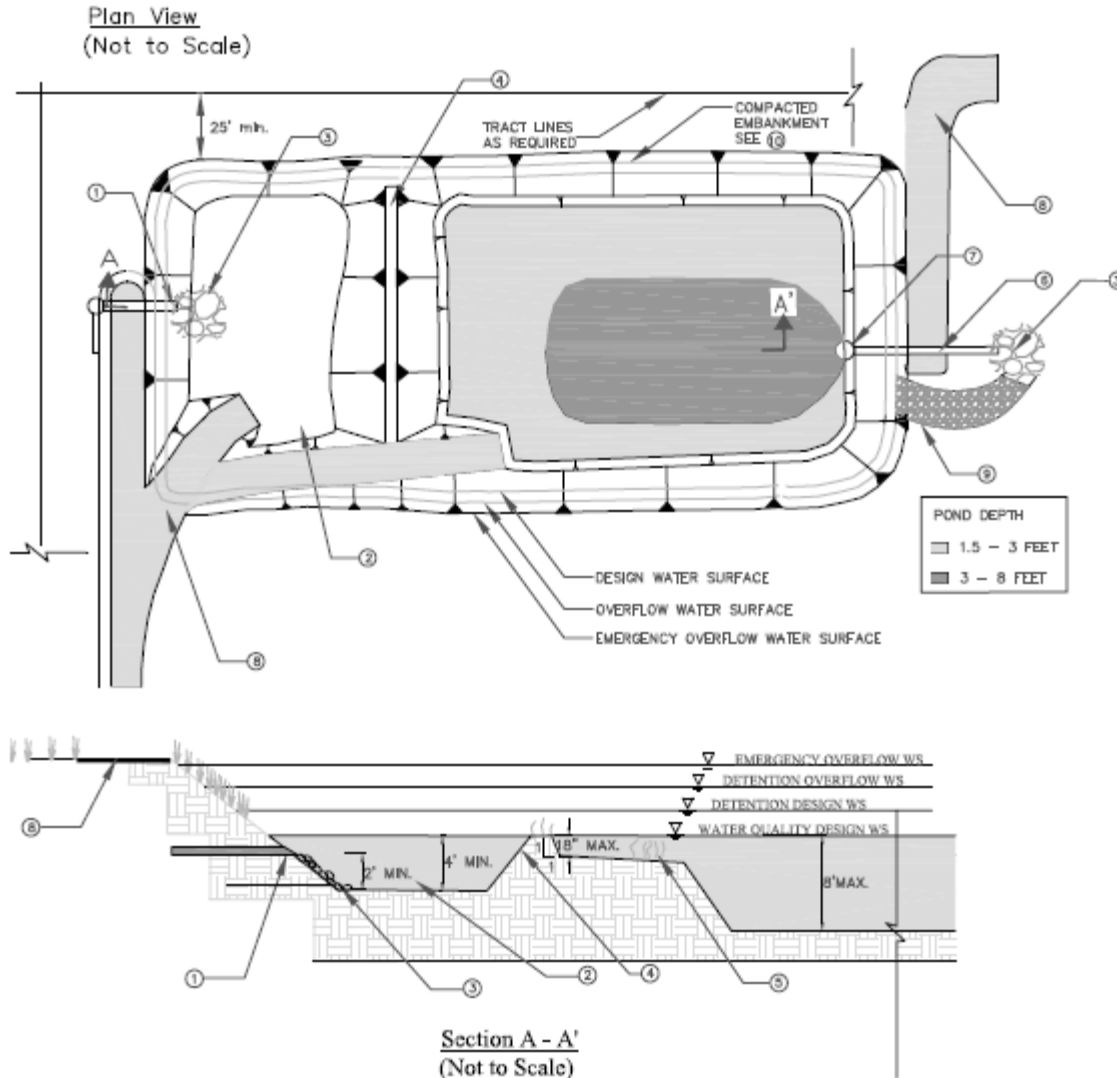

NOTES:

- ① INLET PIPE SHOULD BE SUBMERGED WITH A MINIMUM OF 2' DISTANCE FROM THE BOTTOM
- ② FIRST CELL VOLUME SHALL EQUAL 25% TO 35% OF TOTAL WETPOND VOLUME. DEPTH SHALL BE 4' MIN TO 8' MAX PLUS AN ADDITIONAL 1' MIN SEDIMENT STORAGE DEPTH.
- ③ RIP RAP APRON OR OTHER ENERGY DISSIPATION.
- ④ BERM SHALL EXTEND ACROSS ENTIRE WIDTH OF THE WETPOND.
- ⑤ EMERGENT VEGETATION SHALL BE PLANTED IN REGIONS OF THE POND THAT ARE 3' DEEP OR LESS.
- ⑥ SIZE OUTLET PIPE TO PASS 100-YEAR PEAK FLOW FOR ON-LINE PONDS AND WATER QUALITY PEAK FLOW FOR OFF-LINE PONDS.
- ⑦ WATER QUALITY OUTLET STRUCTURE.
- ⑧ MAINTENANCE ACCESS ROAD SHOULD PROVIDE ACCESS TO BOTH THE FIRST CELL AND MAIN BASIN.
- ⑨ INSTALL EMERGENCY OVERFLOW SPILLWAY AS NEEDED.

Figure E-21. Wet Pond Schematic

General Constraints and Implementation Considerations

- Wet ponds are appropriate for use in the following settings:
 - Where there is a need to achieve a reasonably high level of dissolved pollutant removal and/or sediment capture;
 - Where base flow rates or other channel flow sources are relatively consistent year-round; or
 - In residential settings where aesthetic and wildlife habitat benefits can be appreciated and maintenance activities are likely to be consistently undertaken.
- Tributary drainage areas are typically small to medium-sized regional areas greater than approximately ten acres with available open space.
- Land area requirements for wet ponds are approximately two to three percent of the tributary development area.
- Wet ponds are most appropriate for sites with low-permeability soil, which help to maintain the permanent pool.
- Wet ponds are not permitted near steep slope hazard areas.
- An impermeable liner may be required to maintain permanent pool level in areas with porous soils.
- Seepage collars may be required on outlet pipes to prevent seepage through embankments.

Design Specifications

The following sections describe the design specifications for wet ponds.

Geotechnical

Implementation of a wet ponds in areas with high permeability soils (>0.3 in/hr) requires impermeable liners to maintain permanent pools and/or micro-pools in the pond. Liners can be either synthetic materials (geomembrane liner) or imported lower permeability soils (i.e., clays). A water balance should be conducted to determine whether a liner is required. The following conditions can be used as a guideline:

- The sediment forebay must retain at least three feet of water year-round in order for pre-settling to be effective.
- The permanent pool must retain water for at least ten months of the year. Because plants can adapt to periods of summer drought, a limited drought period is allowed in the permanent pond. This may allow for a soil liner rather than a geomembrane liner.

If low permeability soils are used for the liner, a minimum of 18 inches of native soil amended with good topsoil or compost (one part compost mixed with three parts native

soil) must be placed over the liner. If a synthetic liner is used, a soil depth of two feet is recommended to prevent damage to the liner during planting.

Pretreatment

If a sediment forebay is used for pretreatment to remove coarse solids, it may be constructed with an internal berm made out of earthen embankment material, grouted riprap, or other structurally-sound material.

- The sediment forebay must have a volume equal to five to ten percent of the total wet pond volume.
- The depth of the sediment forebay should be between four and eight feet, excluding sediment storage.
- One foot of sediment storage must be provided in the sediment forebay.
- Permanent steel post depth markers must be placed in the sediment forebay to identify the settled sediment removal limits at 50 and 100 percent of the sediment storage depth.
- A gravity drain outlet from the sediment forebay (minimum four-inch diameter) must extend the entire width of the internal berm.
- The sediment forebay outlet must be off-set from the inflow flow line to prevent short-circuiting.
- All inlets to the wet pond should enter the sediment forebay. If there are multiple inlets, the length-to-width ratio should be based on the average flow path length for all inlets.

Geometry

- Wet ponds consist of at least two cells including a sediment forebay and the permanent pool. The berm separating the two cells must be uniform in cross-section and shaped such that its downstream side gradually slopes into the permanent pool. The top of the berm must be either at the mitigation volume water surface or submerged one foot below the mitigation volume water surface.
- The edge of the wet pond should slope from the surface of the permanent pool to a depth of 12 to 18 inches at a slope of 1:1 (H:V) or greater. If soil conditions cannot support a 1:1 (H:V) slope, then the steepest slope that can be supported should be used or a shallow retaining wall constructed (18 inches maximum). Beyond the edge of the wet pond, a bench sloped at 4:1 (H:V) maximum should extend into the wet pond to a depth of at least three feet. A steeper slope may be used beyond the three foot depth to a maximum of eight feet. The steep slope at the water's edge will minimize very shallow areas that can support vector breeding.
- The side slopes of the berm must meet the following specifications:

- If the top of the berm is at the mitigation volume water surface, the berm side slopes must be no steeper than 3:1 (H:V); or
- If the top of berm is submerged one foot below the mitigation volume water surface, the upstream side slope has a maximum slope of 2:1 (H:V).
- The side slopes of the wet pond must meet the following specifications:
 - The interior side slopes up to the overflow water surface must be no greater than 3:1 (H:V) unless stabilization has been approved by a licensed geotechnical engineer.
 - The exterior side slopes must be no greater than 2:1 (H:V) unless stabilization has been approved by a licensed geotechnical engineer.
 - For any slope (interior or exterior) greater than 2:1 (H:V), a geotechnical report must be submitted and approved by GMED.
 - Pond walls may be vertical retaining walls provided: (a) they are constructed of reinforced concrete; (b) a fence is provided along the top of the wall (see Fencing below) or further back; and (c) the design is stamped by a licensed civil engineer and approved by LACDPW.
- The permanent pool of a wet pond must be sized to treat the volume of stormwater runoff that must be mitigated (Section 7) plus an additional five percent for sediment accumulation. If extended detention is included, then the extended detention volume must provide detention of ten percent of the mitigation volume while the surcharge volume makes up the remaining 90 percent of the sizing.
- At least 25 percent of the permanent pool should be deeper than three feet to prevent growth of emergent vegetation across the entire pond. If greater than 50 percent of the permanent pool is deeper than six feet deep, some form of recirculation must be provided, such as a fountain or aerator, to prevent stratification, stagnation, and low dissolved oxygen conditions.
- The flow path length-to-width ratio should be a minimum of 1.5:1, but preferably 3:1 or greater. A higher flow path length to width ratio increases fine sediment removal.
- A minimum freeboard of one foot above the maximum water surface elevation must be maintained.
- Wet ponds should be designed with a hydraulic residence time for dry weather flows of less than seven days in order to minimize vector breeding and stagnation issues.
- A 25-foot (minimum) buffer must be provided around the top perimeter of the wet pond.

Embankments

Embankments are earthen slopes or berms used for detaining or redirecting the flow of water. The following criteria apply for embankment design:

- The minimum top width of all berm embankments must be 20 feet, unless otherwise approved by a licensed geotechnical engineer and GMED.
- Berm embankments must be constructed on native consolidated soil or adequately compacted and stable fill soils approved by a licensed geotechnical engineer. Soils must be free of loose surface soil materials, roots, and other organic debris.
- All earthworks must be conducted in accordance with the Standard Specifications for Public Works Construction.
- Berm embankments greater than four feet in height must be constructed by excavating a key equal to 50 percent of the berm embankment cross-sectional height and width. This requirement may be waived if specifically recommended by a licensed geotechnical engineer.
- Berm embankments must be constructed of compacted soil (95 percent minimum dry density, Modified Proctor method per ASTM D1557) and placed in six inch lifts.
- Low growing native or non-invasive perennial grasses must be planted on downstream embankment slopes. See Attachment B of the Vegetation Management on Embankment Dams of Public Works' Debris Control Facilities for a recommended plant list.

Sizing

Wet ponds may be designed with or without extended detention above the permanent pool. The extended detention portion of the wet pond above the permanent pool, if provided, functions like an extended detention basin. If there is no extended detention provided, wet ponds must be sized to provide a minimum permanent pool volume equal to the volume of stormwater runoff that must be mitigated plus an additional five percent for sediment accumulation. If extended detention is provided above the permanent pool, the sizing is dependent on the functionality of the wet pond; the wet pond may function as water quality treatment only or water quality treatment plus peak flow attenuation.

If the wet pond is designed for water quality treatment only, then the permanent pool volume should be a minimum of 10 percent of the design volume and the surcharge volume (above the permanent pool) should make up the remaining 90 percent. If extended detention is provided above the permanent pool and the wet pond is designed for water quality treatment, then the permanent pool volume should be equal to the design volume.

Step 1: Calculate the mitigation volume

Wet ponds must be designed to capture and retain the SWQDv (see Section 6 for SWQDv calculation procedures).

Step 2: Determine active design volume for wet pond without extended detention

The active volume of the wet pond (V_a) is equal to the mitigation volume plus an additional five percent for sediment accumulation.

$$V_a = 1.05 \times V_M$$

Where:

V_a = Active volume of wet pond [ft³]; and

V_M = Volume of stormwater runoff to be mitigated [ft³].

Step 3: Determine pond location and preliminary geometry based on site constraints

Based on site constraints, determine the pond geometry and the storage available by developing an elevation-storage relationship for the wet pond. Note that a more natural geometry may be used and is in many cases recommended; the preliminary wet pond geometry calculations should be used for sizing purposes only.

Calculate the width of the wet pond footprint (W_{tot}) as follows:

$$W_{tot} = \frac{A_{tot}}{L_{tot}}$$

Where:

A_{tot} = Total surface area of wet pond footprint [ft²]; and

L_{tot} = Total length of wet pond footprint [ft].

Calculate the length of the active volume surface area (L_{av-tot}), including the internal berm, but excluding the freeboard as follows:

$$L_{av-tot} = L_{tot} - 2 \times Z \times d_{fb}$$

Where:

L_{tot} = Total length of wet pond footprint [ft];

Z = Interior side slope as length per unit height [ft/ft]; and

d_{fb} = Freeboard depth [ft].

Calculate the width of the active volume surface area (W_{av-tot}), including the internal berm, but excluding the freeboard as follows:

$$W_{av-tot} = W_{tot} - 2 \times Z \times d_{fb}$$

Where:

W_{tot} = Total width of wet pond footprint [ft];
 Z = Interior side slope as length per unit height [ft/ft]; and
 d_{fb} = Freeboard depth [ft].

Calculate the total active volume surface area (A_{av-tot}), including the internal berm, but excluding the freeboard as follows:

$$A_{av-tot} = L_{av-tot} \times W_{av-to}$$

Where:

L_{av-tot} = Length of total active volume surface area [ft]; and
 W_{av-tot} = Width of total active volume surface area [ft].

Calculate the area of the berm (A_{berm}) as follows:

$$A_{berm} = L_{berm} \times W_{berm}$$

Where:

L_{berm} = Length of berm [ft]; and
 W_{berm} = Width of berm [ft].

Calculate the active volume surface area (A_{wq}), excluding the internal berm and freeboard as follows:

$$A_{wq} = A_{av-tot} - A_{berm}$$

Where:

A_{av-tot} = Total active volume surface area, including the internal berm, but excluding the freeboard [ft²]; and
 A_{berm} = Area of berm [ft²].

Step 4: Determine Dimensions of Sediment Forebay

The wet pond should be divided into two cells separated by a berm. The sediment forebay should contain between five and ten percent of the total wet pond volume. The berm volume should not count as part of the total volume. Calculate the active volume of the sediment forebay (V_f) as follows:

$$V_f = \frac{V_a \times \%V_f}{100}$$

Where:

V_a = Active volume of wet pond [ft³]; and
 $\%V_f$ = Percent of mitigation volume in sediment forebay [%].

Calculate the surface area for the active volume of sediment forebay (A_f) as follows:

$$A_f = \frac{V_f}{d_f}$$

Where:

V_f = Active volume of the sediment forebay [ft³]; and
 d_f = Average depth of the active volume of sediment forebay [ft].

Calculate the length of the sediment forebay (L_f). Note that the inlet and outlet should be configured to maximize the hydraulic residence time.

$$L_f = \frac{A_f}{W_f}$$

$$W_f = W_{av-tot} = L_{berm}$$

Where:

A_f = Surface area for the active volume of sediment forebay [ft²];
 W_f = Width of sediment forebay [ft];
 W_{av-tot} = Width of total active volume surface area [ft]; and
 L_{berm} = Length of berm [ft].

Step 5: Determine Dimensions of Permanent Pool

The permanent pool will consist of the remainder of the active volume of the wet pond. Calculate the active volume of the permanent pool (V_p) as follows:

$$V_p = V_a - V_f$$

Where:

V_a = Active volume of wet pond [ft³]; and
 V_f = Active volume of the sediment forebay [ft³].

The minimum permanent pool surface area includes 0.3 acres of permanent pool per acre-foot of permanent pool volume. Calculate $A_{p,min}$:

$$A_{p,min} = 0.3 \frac{\text{acres}}{\text{acre-ft}} \times V_p$$

Where:

V_p = Active volume of the permanent pool [ft³].

Calculate the actual permanent pool surface area (A_p) as follows:

$$A_p = A_{wq} - A_f$$

Where:

A_{wq} = Active volume surface area [ft²]; and
 A_f = Active volume of the forebay [ft²].

Verify that A_p is greater than $A_{p,min}$. If A_p is less than $A_{p,min}$, modify the input parameters to increase A_p until it is greater than $A_{p,min}$. If site constraints limit this criterion, then another site for the wet pond should be selected.

Calculate the top length of the permanent pool (L_p) as follows:

$$L_p = \frac{A_p}{W_p}$$

$$W_p = W_f = W_{av-tot} = L_{berm}$$

Where:

A_p = Surface area for the active volume of permanent pool [ft²];
 W_p = Width of permanent pool [ft];
 W_f = Width of forebay [ft];
 W_{av-tot} = Width of total active volume surface area [ft]; and
 L_{berm} = Length of berm [ft].

Verify that the length-to-width ratio of the permanent pool is at least 1.5:1 with greater than 2:1 preferred. If the length-to-width ratio is less than 1.5:1, modify the input parameters until a ratio of at least 1.5:1 is achieved. If the input parameters cannot be modified as a result of site constraints, another site for the wet pond should be selected.

Flow Entrance and Energy Dissipation

The inlet to the wet pond must be submerged with the inlet pipe invert a minimum of two feet from the bottom (not including sediment storage). The top of the inlet pipe should be submerged at least one foot, if possible. A submerged inlet will dissipate energy from incoming flow. The distance from the bottom is set to minimize resuspension of settled sediments. Alternative inlet designs that accomplish these objectives are acceptable. Energy dissipation controls must also be used at the outlet from the wet pond unless it discharges to the storm drain system or a hardened channel. Consult

with LACDPW for the appropriate the type and design of the energy dissipation structure.

Water Supply

A water balance must be conducted to demonstrate that adequate water supply will be present to maintain a permanent pool of water during a drought year when precipitation is 50 percent of average for the site. The water balance must consider evapotranspiration, infiltration, precipitation, spillway discharge, and nuisance flow (where appropriate).

If a water balance indicates that losses will exceed inputs, a source of water must be provided to maintain the water surface elevation throughout the year. The water supply must be of sufficient quantity and quality to not have an adverse impact on the water quality of the wet pond.

Vegetation

Vegetation provides erosion protection from both wind and water and biofiltration of stormwater runoff. If the permanent pool is three feet or shallower, the bottom area should be planted with emergent wetland vegetation for 25 to 75 percent coverage. A mix of erosion-resistant plant species that effectively bind the soil should be used on the slopes and a diverse selection of plants that thrive under the specific site, climatic, and irrigation conditions should be specified for the pool bottom. The pool bottom should not be planted with trees, shrubs, or other large woody plants that may interfere with maintenance activities. Only native perennial grasses, forbs, or similar vegetation that can be replaced via seeding should be used on the pool bottom.

Non-native plant species are not permitted. For more information on invasive weeds, including biology and control of listed weeds, refer to the “encycloveedia” located at the California Department of Food and Agriculture website (http://www.cdfa.ca.gov/plant/ipc/encycloveedia/encycloveedia_hp.htm) or the California Invasive Plant Council website (www.cal-ipc.org).

Other resources for identifying suitable plant types can be found by consulting a nursery, arborist, landscape architect, or referring to online resources such as:

- Calflora (<http://calflora.org>), which is a database of wild California plants that include plant characteristics and photos.
- Los Angeles River Master Plan Landscaping Guidelines and Plant Palettes (http://ladpw.org/wmd/watershed/LA/LAR_planting_guidelines_webversion.pdf), which is a guidance document providing a listing of native plant communities in the Los Angeles area.
- The Jepson Online Interchange California Floristics (<http://ucjeps.berkeley.edu/interchange.html>), which is a database that provides information on identification, taxonomy, distribution, ecology, relationships, and diversity of California vascular plants.

- VegSpec (<http://catalog.data.gov/dataset/vegspec>), which is a web-based decision support system that assists land managers in the planning and design with vegetative establishment practices.
- United States Department of Agriculture (<http://plants.usda.gov/java>), which is an extensive database of native and non-native plants of the United States with over 100 plant characteristics.

Outlet Structure

An outlet pipe and structure must be sized, at a minimum, to pass flows above the mitigation volume of the SWQDv. The outlet pipe may be a perforated riser strapped to a manhole (see Figure E-10) or placed in an embankment suitable for extended detention or may be back-sloped to a catch basin with a grated opening (jail house window) or manhole with a cone grate (birdcage) (see Figure E-9). The grate or birdcage openings provide an overflow route should the wet pond outlet pipe become clogged. For extended detention wet ponds, the outlet structure should be designed to provide a 96-hour retention time for the mitigation volume of the SWQDv above the permanent pool.

Landscaping outside of the wet pond, but within the easement/right-of-way, is required and must adhere to the following specifications such that it will not hinder maintenance operations:

- No trees or shrubs may be planted within ten feet of inlet or outlet pipes or manmade drainage structures such as spillways, flow spreaders, or earthen embankments. Species with roots that seek water, such as willow or poplar, shall not be used within 50 feet of pipes or manmade structures.
- Prohibited non-native plant species will not be permitted.
- Other resources for identifying suitable plant types can be found by consulting a nursery, arborist, landscape architect, or referring to online resources such as:
 - Calflora (<http://calflora.org>), which is a database of wild California plants that include plant characteristics and photos.
 - Los Angeles River Master Plan Landscaping Guidelines and Plant Palettes (http://ladpw.org/wmd/watershed/LA/LAR_planting_guidelines_webversion.pdf), which is a guidance document providing a listing of native plant communities in the Los Angeles area.
 - The Jepson Online Interchange California Floristics (<http://ucjeps.berkeley.edu/interchange.html>), which is a database that provides information on identification, taxonomy, distribution, ecology, relationships, and diversity of California vascular plants.
 - VegSpec (<http://catalog.data.gov/dataset/vegspec>), which is a web-based decision support system that assists land managers in the planning and design with vegetative establishment practices.

- United States Department of Agriculture (<http://plants.usda.gov/java>), which is an extensive database of native and non-native plants of the United States with over 100 plant characteristics.

Fencing

Safety is provided by fencing of the stormwater quality control measure. Fences shall be designed and constructed in accordance with Title 11, Section 11.48 of the Los Angeles County Code and must be located at or above the top of overflow structure elevation. Shrubs (LACDPW-approved, California-adapted species) may be used to conceal the fencing.

Restricted Construction Materials

The use of pressure-treated wood or galvanized metal at or around a wet pond is prohibited. The use of galvanized fencing is permitted if in accordance with the Fencing requirement above.

Overflow Structure and Spillway

An overflow spillway or overflow riser must be provided. The overflow device must be designed to pass the maximum storm size diverted to the wet pond, with a minimum one-foot freeboard, directly to the downstream conveyance system or another approved discharge point. If an overflow spillway potentially discharges to a steep slope, an overflow riser and a spillway must be provided. The emergency overflow spillway must be designed to withstand the energy of the spillway flows (see Figure E-). The spillway must be constructed of grouted riprap.

Spillways must meet the California Department of Water Resources, Division of Safety of Dams *Guidelines for the Design and Construction of Small Embankment Dams* (www.water.ca.gov/damsafety/docs/GuidelinesSmallDams.pdf).

Maintenance Access

Maintenance access must be provided to the drainage structures associated with the wet pond (e.g., inlet, overflow or bypass devices) if it is publicly-maintained. Manhole and catch basin lids must be in or at the edge of the access road. An access ramp to the wet pond bottom is required to facilitate the entry of sediment removal and vegetation maintenance equipment.

Access roads must meet the following design specifications:

- All access ramps and roads must be paved with a minimum of six inches concrete over three inches of crushed aggregate base material. This requirement may be modified depending on the soil conditions and intended use of the road at the discretion of LACDPW.
- The maximum grade is 12 percent unless otherwise approved by LACDPW.

- Centerline turning radius must be a minimum of 40 feet.
- Access roads less than 500 feet long must have 12-foot wide pavement within a minimum 15-foot wide bench. Access roads greater than 500 feet long must have 16-foot wide pavement within a minimum 20-foot wide bench.
- All access roads must terminate with turnaround areas of 40-feet by 40-feet. A hammer type turn around area or a circle drive around the top of the wet pond is also acceptable.
- Adequate double-drive gates and commercial driveways are required at street crossings. Gates should be located a minimum of 25 feet from the street curb except in residential areas where the gates may be located along the property line provided there is adequate sight distance to see oncoming vehicles at the posted speed limit.

Maintenance Requirements

Maintenance and regular inspections are important for proper function of wet ponds. The following are general maintenance requirements:

- Inspect the wet pond annually. Inspections after major storm events are encouraged. Remove trash and debris, as needed, but at least annually prior to the beginning of the wet season.
- Maintain site vegetation as frequently as necessary to maintain the aesthetic appearance of the site and to prevent clogging of outlets, creation of dead spaces, and barriers to mosquito fish to access pooled areas, and as follows:
 - Prune and/or remove vegetation, large shrubs, or trees that limit access or interfere with operation of the wet pond.
 - Re-vegetate slope areas that have become bare. Re-grade eroded areas prior to re-vegetating.
 - Remove and replace invasive vegetation with native vegetation. Invasive species should never contribute more than 25 percent of the vegetated area. For more information on invasive weeds, including biology and control of listed weeds, look at the “encycloveedia” located at the California Department of Food and Agriculture website (http://www.cdfa.ca.gov/plant/ipc/encycloveedia/encycloveedia_hp.htm) or the California Invasive Plant Council website (www.cal-ipc.org).
 - Remove dead vegetation if it exceeds ten percent of area coverage. Replace vegetation immediately to maintain cover density and control erosion where soils are exposed.
 - Do not use herbicides or other chemicals to control vegetation.
- Remove sediment accumulation exceeding 50 percent of the sediment storage capacity of the sediment forebay, as indicated on the permanent steel post depth markers. Test removed sediments for toxic substance accumulation in compliance with current disposal requirements if visual or olfactory indications of

pollution are noticed. If toxic substances are detected at concentrations exceeding thresholds of Title 22, Section 66261 of the California Code of Regulations, dispose of the sediment in a hazardous waste landfill and investigate and mitigate the source of the contaminated sediments to the maximum extent possible.

- Re-establish vegetation, which may require replanting and/or reseeding, following sediment removal activities.

A summary of potential problems that may need to be addressed by maintenance activities is presented in Table E-28.

The County requires execution of a maintenance agreement to be recorded by the property owner for the on-going maintenance of any privately-maintained stormwater quality control measures. The property owner is responsible for compliance with the maintenance agreement. A sample maintenance agreement is presented in Appendix H.

Table E-28. Wet Pond Troubleshooting Summary

Problem	Conditions When Maintenance Is Needed	Maintenance Required
Trash and Debris	Trash and debris > 5 ft ³ /1,000 ft ² If less than threshold all trash and debris will be removed as part of next scheduled maintenance.	Remove and dispose of trash and debris.
Contaminants and Pollution	Any evidence of oil, gasoline, contaminants, or other pollutants	Remove any evidence of visual contamination. Dispose of materials contaminated with petroleum hydrocarbons in accordance with applicable laws.
Vegetation	Overgrown vegetation	Mow and trim vegetation to prevent establishment of woody vegetation, and for aesthetics and vector control reasons.
	Presence of invasive, poisonous, nuisance, or noxious vegetation or weeds	Remove this vegetation.
	Algae mats covering more than 20 percent of surface	Remove algae mats.
Sediment Accumulation	Accumulation of sediment, debris, and oil/grease in forebay, pretreatment devices, surface, inlet, or overflow structures	Remove sediment when accumulation reaches six inches or if resuspension is observed. (Note: Sediment removal may not be required in the permanent pool for as long as 20 years.) Re-grade if necessary.
Erosion	Undercut or eroded areas at inlet structures Animal burrows present	Repair eroded areas and re-grade if necessary.
Water Drainage Rate	Infiltrating water	Repair or replace liner if necessary to maintain a permanent pool.

T-5: Permeable Pavement with an Underdrain

Description

Permeable pavement includes permeable interlocking concrete pavers, pervious concrete, or porous asphalt pavement that is flat in all directions. Permeable pavement can be used to infiltrate stormwater runoff into the porous pavement and sublayers of sand and gravel and subsequently into the underlying soil and slowly exits through an underdrain.



Permeable interlocking concrete pavement is comprised of a layer of durable concrete pavers or blocks separated by joints filled with small stones. Pervious concrete is made from carefully controlled amounts of water and cement materials used to create a paste that forms a thick coat around aggregate particles. Unlike conventional concrete, the mixture contains little or no sand, which creates a substantial void content (between 15 and 25 percent). Porous asphalt, or “open-graded” asphalt, pavement contains no fine aggregate particles, which creates void spaces in the pavement and allows water to collect within and drain through the pavement. An alternative approach for permeable pavement is to use stabilized grassy porous pavement, consisting of grass turf reinforced with plastic rings and filter fabric underlain by gravel.

A schematic of permeable pavement with an underdrain is presented in Figure E-22.

For advantages and disadvantages, general constraints and implementation considerations, and design specifications with the exception of the underdrain design, see Fact Sheet RET-5 (Permeable Pavement without an Underdrain).

LID Ordinance Requirements

Permeable pavement with an underdrain can be used as a stormwater quality control measure to treat stormwater runoff for the following alternative compliance measures:

- Off-site infiltration;
- Groundwater replenishment projects; and
- Off-site retrofit of existing development.

The project applicant must ensure that all pollutants of concern are addressed when using permeable pavement with an underdrain (see Section 7.4). The following table

T-5: Permeable Pavement with an Underdrain

identifies the pollutants of concern that are treated to the water quality benchmark (see Table 7-2 of the LID Standards Manual) by permeable pavement with an underdrain:

Pollutant of Concern	Treated by Permeable Pavement with an Underdrain?
Suspended solids	Yes
Total phosphorus	Yes
Total nitrogen	No
Total Kjeldahl nitrogen	Yes
Cadmium, total	Yes
Chromium, total	No
Copper, total	No
Lead, total	Yes
Zinc, total	Yes

Source: Treatment Best Management Practices Performance, Los Angeles Regional Water Quality Control Board, December 9, 2013.

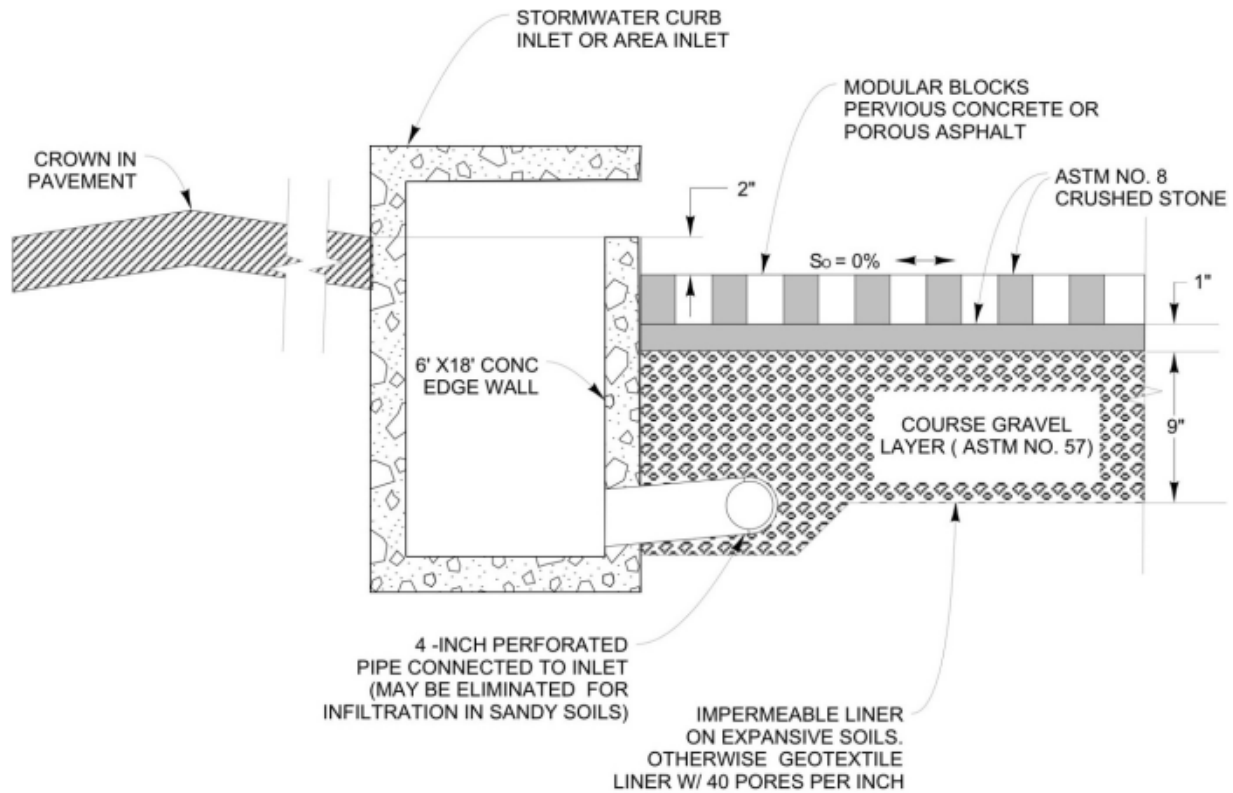

ADAPTED FROM UDFCD, 1999

Figure E-122. Permeable Pavement with an Underdrain Schematic

T-5: Permeable Pavement with an Underdrain

Design Specifications

The following sections provide design specifications for the underdrain.

Underdrain

Permeable pavement can be used with an underdrain to collect and discharge stormwater runoff that has been filtered through the soil media, but not infiltrated, to another stormwater quality control measure, storm drain system, or receiving water. The underdrain shall have a mainline diameter of eight inches using slotted PVC SDR 26 or PVC C9000. Slotted PVC allows for pressure water cleaning and root cutting, if necessary. The slotted pipe should have two to four of slots cut perpendicular to the axis of the pipe or at right angles to the pitch of corrugations. Slots should be 0.04 to 0.1 inches wide with a length of 1 to 1.25 inches. Slots should be longitudinally-spaced such that the pipe has a minimum of one square inch opening per lineal foot and should face down.

The underdrain should be placed in a gravel envelope (Class 2 Permeable Material per Caltrans Spec. 68-1.025) that measures three feet wide and six inch deep bed of gravel. The underdrain is elevated from the bottom of the permeable pavement by six inches within the gravel envelope to create a fluctuating anaerobic/aerobic zone below the underdrain to facilitate denitrification within the anaerobic/anoxic zone and reduce nutrient concentrations. The top and sides of the underdrain pipe should be covered with gravel to a minimum depth of 12 inches. The underdrain and gravel envelope should be covered with a geomembrane liner to prevent clogging. The following aggregate should be used for the gravel envelope:

Particle Size (ASTM D422)	% Passing by Weight
¾ inch	100%
¼ inch	30-60%
#8	20-50%
#50	3-12%
#200	0-1%

Underdrains should be sloped at a minimum of 0.5 percent, and must drain freely to an acceptable discharge point.

Rigid non-perforated observation pipes with a diameter equal to the underdrain diameter should be connected to the underdrain to provide a clean-out port as well as an observation well to monitor drainage rates. The wells/clean-outs should be connected to the perforated underdrain with the appropriate manufactured connections. The wells/clean-outs must be capped with a lockable screw cap. The ends of underdrain pipes not terminating in an observation well/clean-out should also be capped.

T-5: Permeable Pavement with an Underdrain

Maintenance Requirements

Maintenance and regular inspections are of important for proper function of permeable pavement with an underdrain. The following are general maintenance requirements:

- Inspect permeable pavement to determine if stormwater runoff is infiltrating properly at least twice during the wet season after significant storms. If infiltration is significantly reduced, remove surface aggregate by vacuuming. Dispose of and replace old aggregate with fresh aggregate as needed.
- Sweep permeable pavement as needed to clean it of leaves, debris, and sediment. Do not overlay permeable pavement with an impermeable surface.
- Prune vegetation and large shrubs/trees that limit access or interfere with permeable pavement operation. Rake and remove fallen leaves and debris from deciduous plant foliage. Remove poisonous, nuisance, dead, or odor-producing vegetation immediately. Mow grass to less than four inches and bag and remove grass clippings.
- Provide irrigation as needed.
- Exercise spill prevention measures when handling substances that can contaminate stormwater runoff. Implement a spill prevention plan at all non-residential sites and in areas where there is likelihood of spills.
- Eliminate standing water to prevent vector breeding.
- Inspect overflow devices for obstructions or debris, which should be removed immediately. Repair or replace damaged pipes upon discovery.
- Provide safe and efficient access to permeable pavement. Egress and ingress routes must be maintained to design standards. Roadways must be maintained to accommodate size and weight of vehicles if applicable.
- Remove obstacles that may prevent maintenance personnel and/or equipment access to the permeable pavement.
- Limit and control application of pesticides (using Integrated Pest Management practices) and fertilizers to reduce potential pollutant runoff.
- Fill and compact holes in the ground located in and around permeable pavement.
- Identify and control sources of erosion damage when native soil is exposed near the overflow device.
- Add gravel or ground cover if erosion occurs due to vehicular or pedestrian traffic.
- Inspect, and clean if necessary, the underdrain.

A summary of potential problems that may need to be addressed by maintenance activities is presented in Table E-29.

T-5: Permeable Pavement with an Underdrain

The County requires execution of a maintenance agreement to be recorded by the property owner for the on-going maintenance of any privately-maintained stormwater quality control measures. The property owner is responsible for compliance with the maintenance agreement. A sample maintenance agreement is presented in Appendix H.

Table E-29. Permeable Pavement Troubleshooting Summary

Problem	Conditions When Maintenance Is Needed	Maintenance Required
Vegetation	Overgrown vegetation	Mow and trim vegetation.
	Presence of invasive, poisonous, nuisance, or noxious vegetation or weeds	Remove this vegetation.
	Excessive loss of turf or ground cover	Replant and/or reseed as needed.
Trash and Debris	Trash and debris present	Remove and dispose of trash and debris.
Contaminants and Pollution	Any evidence of oil, gasoline, contaminants, or other pollutants	Remove any evidence of visual contamination.
Sediment Accumulation	Accumulation of sediment, debris, and oil/grease on surface, inlet or overflow structures	Remove sediment, debris, and/or oil/grease.
Erosion	Eroded areas at overflow structures	Fill eroded areas and re-grade if necessary.
Water Drainage Rate	Standing water	Vacuum aggregate to remove sediment. Replace aggregate if necessary. Inspect, and clean as needed, the underdrain to ensure proper function. Clear clogs as needed.

T-6: Proprietary Treatment Control Measures

Definition

The LID Standards Manual provided information for selecting and designing the more common treatment-based stormwater quality control measures for projects. The treatment-based stormwater quality control measures included in this appendix (T-1 to T-5) are non-proprietary (public domain) designs that have been reviewed and evaluated by LACDPW and determined generally acceptable.

Proprietary devices are commercial products that typically aim at providing stormwater treatment in space-limited applications, often using patented innovative technologies. The most commonly encountered classes of proprietary stormwater quality control measures include hydrodynamic separation, catch basin insert technologies, cartridge filter-type controls, and proprietary biotreatment devices.

Hydrodynamic separation devices (alternatively, swirl concentrators) are devices that remove trash, debris, and coarse sediment from incoming flows using screening, gravity settling, and centrifugal forces generated by forcing the influent into a circular motion. By having the water move in a circular fashion, rather than a straight line, it is possible to obtain significant removal of suspended sediments and attached pollutants with less space as compared to wet vaults and other settling devices. Hydrodynamic devices were originally developed for combined sewer overflows, where they were used primarily to remove coarse inorganic solids. Hydrodynamic separation has been adapted for stormwater treatment by several manufacturers and is currently used to remove trash, debris, and other coarse solids down to sand-sized particles. Several types of hydrodynamic separation devices are also designed to remove floating oils and grease using sorbent media.

Catch basin inserts are manufactured filters or fabric placed in a drop inlet to remove sediment and debris and may include sorbent media to remove floating oils and grease. There are a multitude of inserts of various shapes and configurations, typically falling into one of three groups: socks, boxes, and trays. The sock-type filters are typically constructed of a fabric, usually polypropylene. The fabric may be attached to a frame or the grate of the inlet may hold the sock. Socks are meant for vertical (drop) inlets. Boxes are constructed of plastic or wire mesh. Typically a polypropylene “bag” is placed in the wire mesh box and the bag takes the form of the box. Most box products are one box; that is, settling and filtration through media occur in the same box. Other products consist of one or more trays or mesh grates. The trays may hold different types of media. Filtration media vary by manufacturer. Types include polypropylene, porous polymer, treated cellulose, and activated carbon. Inserts are an easy and inexpensive retrofitting option because drain inlets are already a component of most standard drainage systems. Inserts are usually only suitable for mitigating relatively small tributary areas (less than one acre) because they are limited by treatment capacity and influent flow rate.

T-6: Proprietary Treatment Control Measures

Cartridge filter-type controls typically consist of a series of vertical filters contained in a vault or catch basin that provide treatment through filtration and sedimentation. The vault may be divided into multiple chambers where the first chamber acts as a pre-settling basin for removal of coarse sediment while another chamber acts as the filter bay and houses the filter cartridges. The performance and capacity of a cartridge filter installation depends on the properties of the media contained in the cartridges. Cartridge filter manufacturers often provide an array of media types each with varying properties, targeting various pollutants and a range of particle sizes. Commonly used media include media that target solids, such as perlite, and media that target both dissolved and non-dissolved constituents, such as compost leaf media, zeolite, and iron-infused polymers. Manufacturers try to distinguish their products through innovative designs that aim at providing self cleaning and draining, uniformly loaded, and clog resistant cartridges that functional properly over a wide range of hydraulic loadings and pollutant concentrations.

Proprietary biotreatment devices are devices that are manufactured to mimic natural systems such as wetlands by incorporating plants, soil, and microbes engineered to provide treatment at higher flow rates or higher volumes and with smaller footprints than their natural counterparts. Incoming flows are typically filtered through natural media (mulch, compost, soil, plants, microbes, etc) and either infiltrated or collected by an underdrain and delivered to the storm system. Tributary areas for biotreatment devices tend to be limited to 0.5 to 1.0 acres.

The vendors of the various proprietary stormwater quality control measures provide detailed documentation for device selection, sizing, and maintenance requirements. Tributary area sizes are limited to the capacities of the largest available model. The latest manufacturer supplied documentation must be used for sizing and selection of all proprietary devices. Links to the websites of a number of vendors of proprietary devices are provided at www.BMPLA.org. All proprietary devices proposed for use by a project applicant must be approved by LACDPW.

General Design Specifications

Proprietary stormwater quality control measure vendors are constantly updating and expanding their product lines, so refer to the latest design guidance from the vendors. General guidelines on the performance, sizing, and operation and maintenance of proprietary devices are provided through LACDPW Watershed Division.

Expected Performance

For hydrodynamic devices, it has been stated with respect to combined sewer overflows that the practical lower limit of hydrodynamic separation is a particle with a settling velocity of 12 to 16.5 ft/hr (0.10 to 0.14 cm/s). As such, the focus for hydrodynamic separation in combined sewer overflows has been with settleable solids generally 200 μm and larger, given the presence of the lighter organic solids. For inorganic sediment, the above settling velocity range represents a particle diameter of 50 to 100 μm . Thus, hydrodynamic separation devices are effective for removal of coarse sediment, trash,

T-6: Proprietary Treatment Control Measures

and debris and useful for pretreatment in combination with other types of stormwater quality control measures that target smaller particle sizes.

Because there is a wide range of catch basin insert configurations, it is not possible to generalize the expected performance. Inserts should mainly be used for catching coarse sediments and floatable trash, and are effective for pretreatment in combination with other types of stormwater quality control measures. Trash and large objects can greatly reduce the effectiveness of catch basin inserts with respect to sediment and hydrocarbon capture. Frequent maintenance and the use of screens and grates to keep trash out may decrease the likelihood of clogging and prevent obstruction and bypass of incoming flows.

Cartridge filters have been proven to provide efficient removals for both dissolved and non-dissolved pollutants. However, cartridge filters are less adept at handling high flow rates when compared to catch basin inserts and hydrodynamic devices due to the enhanced treatment provided through the filtration mechanism.

Because proprietary biotreatment devices are relatively new compared to the other types of proprietary treatment devices included in the LID Standards Manual, there are fewer third party studies on proprietary biotreatment devices. The available performance information is mostly vendor-supplied. According to the vendors, like their natural counterparts, proprietary biotreatment devices are highly efficient at mitigating dissolved metals, nutrients, and suspended solids.

Sizing

Hydrodynamic devices, catch basin inserts, and cartridge filters are flow-based stormwater quality control measures, but can be sized to capture and treat the mitigation volume of the SWQDv with additional facilities to manage stormwater runoff flow. Proprietary biotreatment devices on the other hand include both volume-based and flow-based stormwater quality control measures. Volume-based proprietary devices should be sized to capture and treat the mitigation volume of the SWQDv if used as a standalone stormwater quality control measure.

Auxiliary components of proprietary devices such as sorbent media, screens, baffles, and sumps are selected based on site-specific conditions such as the expected loading and the desired frequency of maintenance. Sizing of proprietary devices is reduced to a simple process whereby a model can simply be selected from a table or a chart based on a few known quantities (tributary area, location, design flow rate, design volume, etc). Some manufacturers either size the devices for potential clients or offer calculators on their websites that simplify the design process even further and lessens the possibility of using obsolete design information. For the latest sizing guidelines, refer to the manufacturer's website.

T-6: Proprietary Treatment Control Measures

Operation and Maintenance

Hydrodynamic Separation Devices

Hydrodynamic separators do not have moving parts and are not maintenance intensive. However, maintenance is important to ensure that the device operates as efficiently as possible. Proper maintenance involves frequent inspections throughout the first year of installation, especially after major storm events. The systems are considered full when the sediment level is within one foot from the top of the unit, at which point it must be cleaned out. Removal of sediment can be performed with a sump vacuum or vactor truck. Some hydrodynamic separator devices may contribute to mosquito breeding if they do not fully drain stormwater runoff between storm events. Refer to manufacturer's guidelines for inspection and maintenance activities.

Catch Basin Inserts

Catch basin inserts can be maintenance-intensive because of their susceptibility for accumulating trash and debris. Regular maintenance activities include the clean-up and removal of accumulated trash and sediment while major maintenance activities include replacing filter media (if used) and or repairing/replacing geomembrane fabrics. Refer to manufacturer's guidelines for inspection and maintenance activities.

Cartridge Filters

For cartridge filters, maintenance activities include periodically removing trash, debris, and sediment from the vault floor, typically twice per year depending on the accumulation rate, using a sump vacuum or vactor truck. The cartridges may need to be replaced when they become saturated, which will occur approximately every other year depending on the pollutant accumulation rate. The manufacturers of these devices typically provide contract operation and maintenance services.

All stormwater vaults that contain standing water can become a breeding area for vectors. Manufacturers have developed systems, such as a perforated pipe installed in the bottom of the vault that is encased in a filter sock to prevent clogging, to completely drain the vault.

Biotreatment Devices

Maintenance of biotreatment devices can be provided by the manufacturer and typically consists of routine inspection and hand removal of accumulated trash and debris. Vactor trucks or mechanical maintenance activities are not needed for biotreatment devices.

APPENDIX **F**

Stormwater Quality Control Measure Examples

Stormwater Quality Control Measure Design Example for Designated Project

This example assumes a commercial development that is greater than 10,000 square feet with the following characteristics:

- Subarea = 1a
- Development area = 5 ac
- Development is 95% impervious
- Soil Type = 2
- 85th percentile, 24-hour storm total = 1.1 in
- Flow path = 680 ft
- Average slope = 4.4%
- Corrected in-situ infiltration rate = 0.94 in/hr

Select Bioretention for Stormwater Quality Control Measure

Step 1: Determine the SWQDv

Use the HydroCalc to calculate the stormwater quality design volume (SWQDv) based on the information provided above. The SWQDv is 0.39 ac-ft, or 17,000 ft³.

Step 2: Determine the design infiltration rate

The design infiltration rate is the corrected in-situ infiltration rate as determined according to the most recent Geotechnical and Materials Engineering Division (GMED) Policy GS 200.1. The design infiltration rate (f_{design}) is 0.94 in/hr.

Step 3: Calculate the bioretention surface area

Determine the maximum depth that can be infiltrated within the maximum retention time:

$$d_{max} = \frac{f_{design}}{12} \times t$$

Where:

d_{max} = Maximum depth of water that can be infiltrated within the maximum detention time [ft];

f_{design} = Design infiltration rate [in/hr]; and

t = Maximum retention time (max 96 hrs) [hr].

Appendix F – Stormwater Quality Control Measure Examples

$$d_{max} = \frac{f_{design}}{12} \times t = \frac{0.94 \text{ in/hr}}{12 \text{ in/ft}} \times 96 \text{ hr} = 7.5 \text{ ft}$$

Select a ponding depth less than the maximum ponding depth.

$$d_{max} \geq d_p$$

Where:

d_{max} = Maximum depth of water that can be infiltrated within the maximum detention time [ft]; and

d_p = Ponding depth [ft].

$$d_p = 6 \text{ ft}$$

Next calculate the infiltrating surface area (bottom of the bioretention area) required using the following equation:

$$A = \frac{SWQDv}{d_p}$$

Where:

A = Bottom surface area of bioretention area [ft²];

$SWQDv$ = Stormwater quality design volume [ft³]; and

d_p = Ponding depth (max 1.5 ft) [ft].

$$A = \frac{SWQDv}{d_p} = \frac{17,000 \text{ ft}^3}{6 \text{ ft}} = 2,834 \text{ ft}^2$$

Evaluate Stormwater Runoff Harvest and Use

If it is not technically feasible to retain the full $SWQDv$ on-site through infiltration, the project applicant should evaluate the feasibility of stormwater runoff harvest and use. If it is not feasible to harvest and use stormwater runoff, the project applicant must identify alternative compliance measures to handle the portion of the $SWQDv$ that cannot be reliably retained on-site. Alternative compliance measures include the following:

- On-site biofiltration of 1.5 times the volume of the $SWQDv$ that is not reliably retained on-site;
- Off-site infiltration/bioretention of the volume of the $SWQDv$ that is not reliably retained on-site;
- Replenishment of groundwater supplies; or

Appendix F – Stormwater Quality Control Measure Examples

- Off-site infiltration/bioretention of the volume of SWQDv that is not reliably retained on-site to retrofit an existing development with similar land uses as the project.

Implement Alternative Off-Site Mitigation

If in the example above it was not technically feasible to reliably retain the full SWQDv on-site, then the volume that cannot be fully retained on-site must be treated. For this example, we will assume that a portion of the SWQDv is not reliably retained on-site and intended for on-site biofiltration before off-site discharge.

Step 1: Calculate the Mitigation Volume

Assume that only 10,000 ft³ may be reliably retained on-site.

$$V_M = 1.5 \times (SWQDv - V_R)$$

Where:

V_M = Mitigation volume;

SWQDv = Stormwater quality design volume; and

V_R = Volume of stormwater runoff reliably retained on-site.

$$V_M = 1.5 \times (SWQDv - V_R) = 1.5 \times (17,000 \text{ ft}^3 - 10,000 \text{ ft}^3) = 10,500 \text{ ft}^3$$

Step 2: Calculate the biofiltration surface area

Determine the ponding depth of the filter:

$$d = t_p \times \frac{f_{\text{design}}}{12}$$

Where:

d = Ponding depth (max 1.5 ft) [ft];

t_p = Required detention time for surface ponding (max 96 hr) [hr]; and

f_{design} = Design infiltration rate [in/hr].

$$d = t_p \times \frac{f_{\text{design}}}{12} = 96 \text{ hr} \times \frac{0.94 \text{ in/hr}}{12 \text{ in/ft}} = 7.52 \text{ ft}$$

Select $d = 3 \text{ ft}$

Determine the biofilter surface area using the following equation:

Appendix F – Stormwater Quality Control Measure Examples

$$A = \frac{V_B}{d}$$

Where:

A = Bottom surface area of the biofiltration area [ft²];

V_B = Biofiltration design volume [ft³]; and

d = Ponding depth [ft];

Assume a sand bed depth of 3 ft.

$$A = \frac{V_B}{d} = \frac{10,500 \text{ ft}^3}{3 \text{ ft}} = 3,500 \text{ ft}^2$$

A biofilter with a surface area of 3,500 ft² is needed to treat the mitigation volume prior to off-site discharge.

Stormwater Quality Control Measure Design Example for Large-Scale Non-Designated Project

This example assumes a residential development with five units with the following characteristics:

- Subarea = 1a
- Development area = 0.75 ac
- Development is 42% impervious
- Soil Type = 2
- 85th percentile, 24-hour storm total = 1.1 in.
- Flow path = 1,080 ft
- Average slope = 1.85%
- Corrected in-situ infiltration rate = 0.94 in/hr

Step 1: Determine the Appropriate Stormwater Quality Design Storm

Since the 85th percentile storm (1.1 in) is greater than the 0.75 in storm, the 85th percentile storm is selected as the design storm size.

Step 2: Determine the design infiltration rate

The design infiltration rate is the corrected in-situ infiltration rate as determined according to the most recent Geotechnical and Materials Engineering Division (GMED) Policy GS 200.1. The design infiltration rate (f_{design}) is 0.94 in/hr.

Step 3: Calculate the Undeveloped Stormwater Runoff Volume

Use the HydroCalc to calculate the stormwater runoff volume from the undeveloped (1% impervious) project site (V_u).

$$V_u = 387 \text{ ft}^3$$

Step 4: Calculate the Developed Stormwater Runoff Volume

Use the HydroCalc to calculate the stormwater runoff volume from the developed project site (V_d).

$$V_d = 1,356 \text{ ft}^3$$

Appendix F – Stormwater Quality Control Measure Examples

Step 5: Calculate the Delta Stormwater Quality Design Volume ($\Delta SWQDv$)

The $\Delta SWQDv$ is calculated using the following equation:

$$\Delta SWQDv = V_d - V_u = 1,356 \text{ ft}^3 - 387 \text{ ft}^3 = 969 \text{ ft}^3$$

Select Stormwater Quality Control Measure

For this example, permeable pavement for the driveways with underlying infiltration trenches has been selected for infiltrating the $\Delta SWQDv$.

Step 6: Calculate the surface area

$$d_{max} = \frac{f_{design}}{12} \times t$$

Where:

d_{max} = Maximum depth of sub-base reservoir layer [ft];

f_{design} = Design infiltration rate [in/hr];

t = Maximum retention time (max 96 hrs) [hr]; and

$$d_{max} = \frac{f_{design}}{12} \times t = \frac{0.94 \text{ in/hr}}{12 \text{ in/ft}} \times 96 \text{ hr} = 7.52 \text{ ft}$$

Select the permeable pavement sub-base reservoir layer depth (d_t) such that:

$$d_t \leq \frac{d_{max}}{n_t}$$

Where:

d_t = Depth of permeable pavement sub-base reservoir layer [ft];

d_{max} = Maximum depth of water that can be infiltrated within the maximum retention time [ft]; and

n_t = permeable pavement sub-base reservoir layer porosity.

Assume $n_t = 0.4$ and $d_t = 2$ ft.

$$d_t \leq \frac{d_{max}}{n_t} = 2 \text{ ft} \leq \frac{7.52 \text{ ft}}{0.4} = 18.8 \text{ ft}$$

Appendix F – Stormwater Quality Control Measure Examples

The required permeable pavement surface area is calculated using the following equation:

$$A_s = \frac{SWQDv}{d_t \times n_t}$$

Where:

A_s = Permeable pavement surface area [ft²];
SWQDv = Stormwater quality design volume [ft³];
 d_t = Depth of permeable pavement sub-base reservoir layer [ft]; and
 n_t = Infiltration trench porosity

$$A_s = \frac{SWQDv}{d_t \times n_t} = \frac{969 \text{ ft}^3}{2 \text{ ft} \times 0.4} = 1,211.25 \text{ ft}^2$$

Each lot will need to provide 242.25 ft² of permeable pavers with a 2 foot sub-base reservoir to comply with the LID requirements.

APPENDIX G

Drainage Acceptance Letter and Owner
Certification Statement Example

RECORDING REQUESTED BY AND MAIL TO:

County of Los Angeles
Department of Public Works

- Building and Safety – Drainage and Grading Section
- Land Development – Drainage and Grading Section
- Land Development – Road/Sewer & Water Section

P.O. Box 1460
Alhambra, California 91802-1460

Space above this line is for Recorder's use

3. ACCEPTANCE OF DRAINAGE BY ADJACENT PROPERTY OWNER

DRAINAGE ACCEPTANCE COVENANT

TR/PM _____

_____, as owner
(name of owner of affected property)

of _____, hereby agrees
 (description of property) (as shown on attached map)

to accept the surface waters emanating from _____
(property description of development)

as provided by drainage plans dated _____ and filed with the Office of the Director of Public Works, County of Los Angeles, and examined by the undersigned, with full knowledge of any alteration in drainage patterns from the natural condition provided by said plans, and hereby agrees for himself, his heirs, successors, and assigns to indemnify, defend and save harmless the County, its agents, officers and employees from and against any and all liability, expense, including defense costs and legal fees, and claims for damage of any nature whatsoever, including but not limited to, bodily injury, death, personal injury, or property damage arising from or connected with said alterations.

(Name if other than an individual)

/s/ _____
(Name if an individual)
(Title if other than an individual)

/s/ _____
(Title if other than an individual)

APPENDIX H

Example Maintenance Agreements

RECORDING REQUESTED BY
AND MAIL TO:

COUNTY OF LOS ANGELES
DEPARTMENT OF PUBLIC WORKS
BUILDING AND SAFETY DIVISION
900 S. FREMONT AVENUE, 3RD FLOOR
ALHAMBRA, CA 91803-1331

Space above this line is for Recorder's use

COVENANT AND AGREEMENT
REGARDING THE MAINTENANCE OF LOW IMPACT DEVELOPMENT (LID) &
NATIONAL POLLUTANTS DISCHARGE ELIMINATION SYSTEM (NPDES) BMPs

The undersigned, _____ ("Owner"), hereby certifies that it owns the real property described as follows ("Subject Property"), located in the County of Los Angeles, State of California:

LEGAL DESCRIPTION

ASSESSOR'S ID # _____ TRACT NO. _____ LOT NO. _____

ADDRESS: _____

Owner is aware of the requirements of the County of Los Angeles' Green Building Standards Code, Title 31, Section 4.106.4 (LID), and National Pollutant Discharge Elimination System (NPDES) permit. The following post-construction BMP features have been installed on the Subject Property:

- Porous pavement
- Cistern/rain barrel
- Infiltration trench/pit
- Bioretention or biofiltration
- Rain garden/planter box
- Disconnect impervious surfaces
- Dry Well
- Storage containers
- Landscaping and landscape irrigation
- Green roof
- Other _____

The location, including GPS x-y coordinates, and type of each post-construction BMP feature installed on the Subject Property is identified on the site diagram attached hereto as Exhibit 1.

Owner hereby covenants and agrees to maintain the above-described post-construction BMP features in a good and operable condition at all times, and in accordance with the LID/NPDES Maintenance Guidelines, attached hereto as Exhibit 2.

Owner further covenants and agrees that the above-described post-construction BMP features shall not be removed from the Subject Property unless and until they have been replaced with other post-construction BMP features in accordance with County of Los Angeles' Green Building Standards Code, Title 31 and NPDES permit.

Owner further covenants and agrees that if Owner hereafter sells the Subject Property, Owner shall provide printed educational materials to the buyer regarding the post-construction BMP features that are located on the Subject Property, including the type(s) and location(s) of all such features, and instructions for properly maintaining all such features.

Owner makes this Covenant and Agreement on behalf of itself and its successors and assigns. This Covenant and Agreement shall run with the Subject Property and shall be binding upon owner, future owners, and their heirs, successors and assignees, and shall continue in effect until the release of this Covenant and Agreement by the County of Los Angeles, in its sole discretion.

Owner(s):

By: _____ Date: _____

By: _____ Date: _____

(PLEASE ATTACH NOTARY)

REFERENCE

PLAN CHECK NO.: _____ DISTRICT OFFICE NO.: _____

ATTACHMENTS

RECORDING REQUEST BY AND MAIL TO:

County of Los Angeles
Department of Public Works

Building and Safety – Drainage and Grading Section
Land Development – Drainage and Grading Section

P.O. Box 1460
Alhambra, California 91802-1460

Space above this line is for Recorder's use

COVENANT FOR MAINTENANCE OF WATER QUALITY (WQ) DEVICES

I (we) _____, hereby certify that I (we) am (are) the legal owner(s) of Tract # _____, and as such owners for the mutual benefit of future purchasers, their heirs, successors, and assigns, do hereby fix the following protective conditions to which their property, or portions thereof, shall be held, sold and/or conveyed.

That owner(s) shall maintain the WQ system shown on attached Exhibit A map and on Grading Plan GPC # _____, on file in the office of the Director of Public Works, in a good and functional condition at least once a year and retain proof of the inspection. The owner(s) shall perform this responsibility, unless the County discharges this obligation through a subsequently recorded written instrument.

The undersigned also covenants and agrees for himself, his heirs, successors, and assigns, to indemnify, defend, and save harmless the County, its agents, officers and employees from and against any and all liability, expenses, including defense costs and legal fees, and claims for damages of any nature whatsoever, including, but not limited to, bodily injury, death, personal injury, or property damage arising from or connected with the construction or maintenance of said work.

Owner(s):

By: _____ Date: _____

By: _____ Date: _____

APPENDIX I

References

Calflora. Information on Wild California Plants. Link: <http://calflora.org>. Last accessed December 10, 2013.

California Department of Water Resources, Division of Safety of Dams. *Guidelines for the Design and Construction of Small Embankment Dams*, January 1993.

California Invasive Species Council. Link: www.cal-ipc.org. Last accessed December 10, 2013.

California Regional Water Quality Control Board Los Angeles Region. *Treatment Best Management Practices Performance*. Personal communication with Ivar Ridgeway. December 9, 2013.

California Regional Water Quality Control Board Los Angeles Region. *Waste Discharge Requirements for Municipal Storm Water and Urban Runoff Discharges within the County of Los Angeles (CAS004001, Order No. 90-079)*. June 28, 1990.

California Regional Water Quality Control Board Los Angeles Region. *Waste Discharge Requirements for Municipal Storm Water and Urban Runoff Discharges within the County of Los Angeles, and the Incorporated Cities therein, except the City of Long Beach (CAS004001, Order No. 01-182)*. December 13, 2001.

California Regional Water Quality Control Board Los Angeles Region. *Waste Discharge Requirements for Municipal Separate Storm Sewer System (MS4) Discharges within the Coastal Watersheds of Los Angeles County, Except those Discharges Originating from the City of Long Beach MS4 (CAS004001, Order No. R4-2012-0175)*. November 8, 2012.

California State Water Resources Control Board. *2012 Integrated Report (CWA Section 303(d) List/305(b) Report)*. March 2013.

California State Water Resources Control Board. *General Permit for Storm Water Discharges Associated with Construction and Land Disturbance Activities (Order No. 2012-0006-DWQ)*. July 17, 2012.

California State Water Resources Control Board. *Waste Discharge Requirements for Discharges of Storm Water Associated with Industrial Activities Excluding Construction Activities (Order No. Order No. 97-03-DWQ)*. April 17, 1997.

California Stormwater Quality Association. *California Stormwater Best Management Practices Handbooks*. 2003.

Center for Watershed Protection. *Urban Stormwater Retrofit Practices Manual 3*. August 2007.

County of Los Angeles. *A Codification of General Ordinances of Los Angeles County, California*. Link: <http://www.lacounty.gov/wps/portal/lac/publicinfo>. Last accessed December 10, 2013.

County of Los Angeles. *Antelope Valley Interim Drainage Policy Memorandum*, October 24, 1986

County of Los Angeles. *Clarification on the policy for Financing the Cost to Maintain Standard Urban Stormwater Mitigation Plan (SUSMP) Devices/Systems Constructed by New Development or Other Agencies*.

County of Los Angeles. *Development Planning for Storm Water Management: A Manual for the Standard Urban Storm Water Mitigation Plan*, September 2002.

County of Los Angeles. *Financing the Cost to Maintain Standard Urban Stormwater Mitigation Plan Devices/Systems*.

County of Los Angeles. *Hydrology Manual*, January 2006.

County of Los Angeles. *Interim Drainage Policy (Acton area)*. October 25, 1989.

County of Los Angeles. *Interim Peak Flow Runoff Criteria for New Development*, January 31, 2005.

County of Los Angeles. *Los Angeles County Green Standards Building Program*. Link: <http://planning.lacounty.gov/green>. Last accessed December 10, 2013.

County of Los Angeles. *Los Angeles River Master Plan Landscaping Guidelines and Plant Palettes*, January 2004.

County of Los Angeles. *Low Impact Development Best Management Guideline for Design, Investigation, and Reporting (Administrative Manual GS 200.1)*. June 2011.

County of Los Angeles. *Low Impact Development Standards Manual*, January 2009.

County of Los Angeles. *Manual for Preparation of Geotechnical Reports*. July 2013.

County of Los Angeles. *Permanent Standard Urban Storm Mitigation Plan Devices for No Fee Miscellaneous Transfer Drains, Small Drainage Systems, and Storm Drain Connection Permits*.

County of Los Angeles. *Policy for New Percolation Basin Testing, Design, and Maintenance*.

County of Los Angeles. *Standard Specifications for Public Works Construction ("Graybook")*. June 2006.

County of Los Angeles. *Stormwater Best Management Practice Design and Maintenance Manual*, August 2010.

County of Los Angeles. *Technical Manual for Stormwater Best Management Practices in the County of Los Angeles*, February 2004.

Appendix I - References

County of Los Angeles. *Vegetation Management on Embankment Dams of Public Works' Debris Control Facilities*. February 2002.

Haltiner, Jeffrey, Philip Williams & Associates, Ltd. *Hydromodification: An Introduction and Overview Presentation*. May 2006.

Los Angeles County Flood Control District. *Design Manual Hydraulic*. March 1982.

Oak Ridge National Laboratory. VegSpec. Link:
<http://catalog.data.gov/dataset/vegspec>. Last accessed December 10, 2013.

United States Department of Agriculture National Resources Conservation Service. *PLANTS Database*. Link: <http://plants.usda.gov/java>. Last accessed December 10, 2013.

United States Department of Agriculture, Natural Resources Conservation Service. *Stream Restoration Design (National Engineering Handbook 654)*. May 2008.

United States Environmental Protection Agency. *Economic Benefits of Runoff Controls*. EPA 841-S-95-002. Link:
http://water.epa.gov/polwaste/nps/econ_ben_runoff_control.cfm. September 1995.

United States Environmental Protection Agency. *Managing Wet Weather with Green Infrastructure: Green Streets 26*. EPA-833-F-08-009. December 2008.

University of California, Berkeley. *The Jepson Online Interchange California Floristics*. Last accessed December 10, 2013.